

Beam Formation

Peter Spädtke
GSI Darmstadt

Beam Formation

- particle generation

- electrons

- ions

What stands beam formation for ?

- extraction

- drift

- post acceleration

USEFUL EQUATIONS

$$\lambda_D = \sqrt{(\epsilon_0 kT_e / e^2 n_e)}$$

Debye length

$$\lambda_D [\text{m}] = 7.43 \sqrt{(T_e [\text{eV}] / n_e [\text{cm}^{-3}])}$$

practical units

$$\omega_p = e^2 n_e / \epsilon_0 m_e$$

plasma frequency

$$\omega_{pe} [\text{Hz}] = 8980 n_e [\text{cm}^{-3}]$$

practical units for electrons

$$\omega_{pi} [\text{Hz}] = 210 n_i [\text{cm}^{-3}] q / A[\text{amu}]$$

practical units for ions



USEFUL EQUATIONS

$$j = 4\epsilon_0/9\sqrt{(2q / m_i \Phi^{1.5}/d^2}$$

Child's law

$$P = I / \Phi^{1.5}$$

perveance

Beam Formation: Electrons

- How to create electrons
- How to create an electron beam

BEAM FORMATION

saturation current density j_{es} for different materials

$$j_{es} = AT^2 \exp(-e\Phi/kT)$$

Φ workfunction [V]

T temperature [K]

material	Φ [V]	A
molybdenum	4.15	55
nickel	4.61	30
tantalum	4.12	60
tungsten	4.54	60
barium	2.11	60
cesium	1.81	160
iridium	5.40	170

BEAM FORMATION

Simple cathode
resistive heating

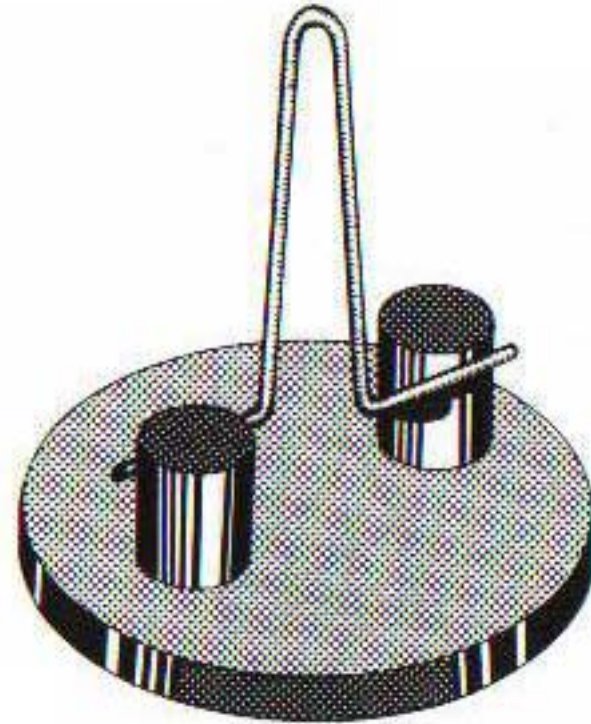

BEAM FORMATION

Pointed cathode
resistive heating

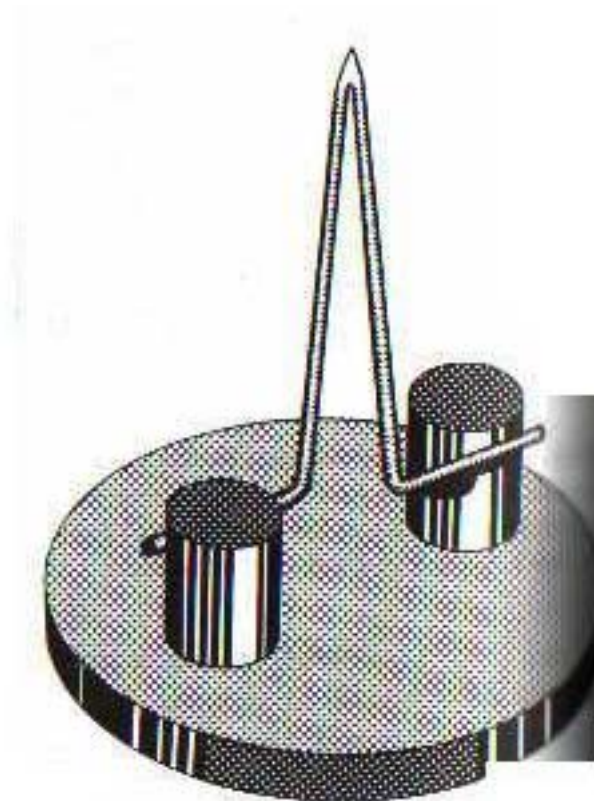

BEAM FORMATION

Alternative cathode materials

electron emission A/cm²

- dispenser cathodes

- LaB₆ cathodes

T (K)	tungsten	tantalum	BaO	LaB ₆
1000			0.5	
1500				
2000		0.2		
2500	0.3			

dispenser cathodes
 maintain emitter in
 emitting temperature of a
 (1600°C)

BEAM FORMATION

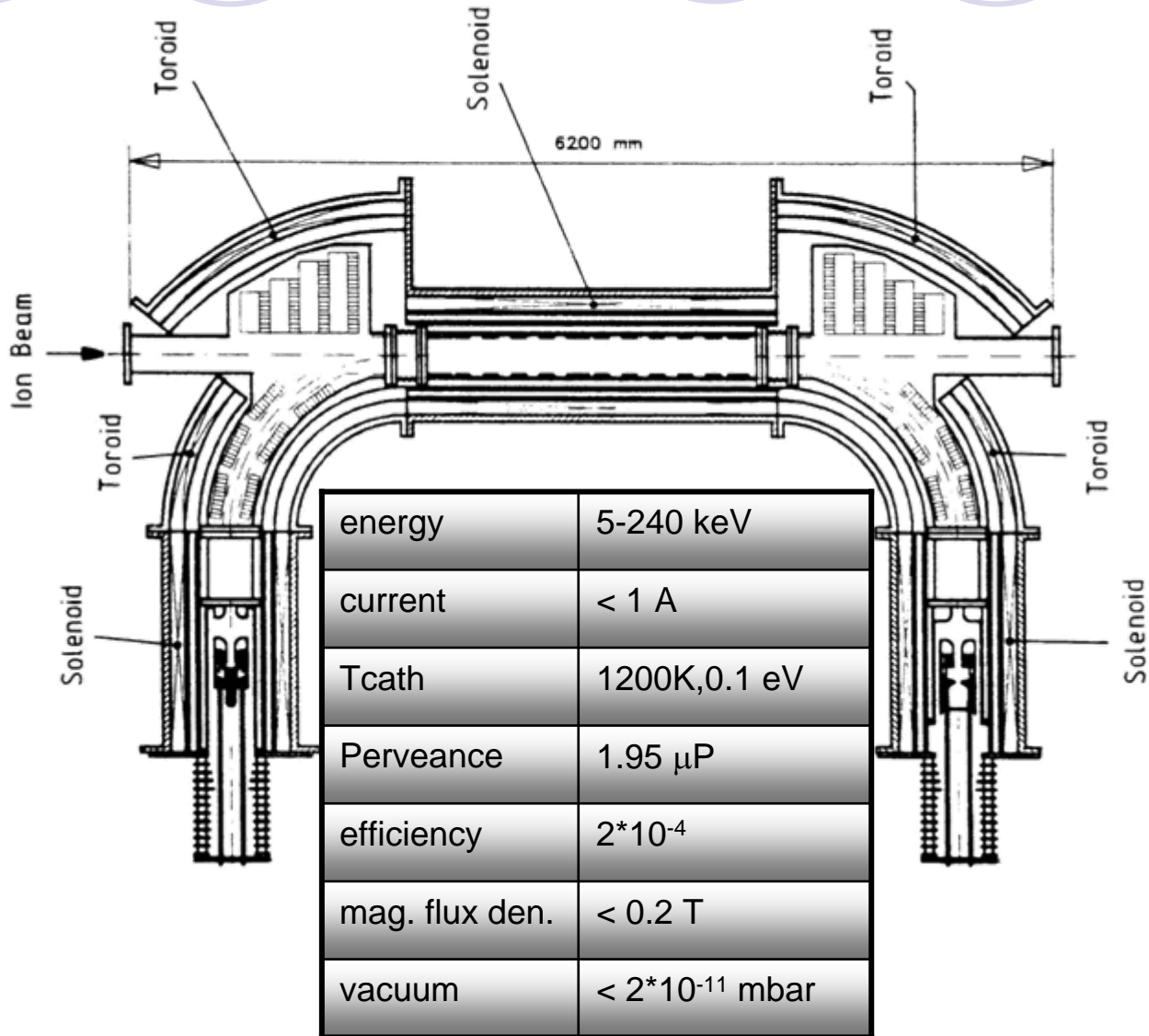

BEAM FORMATION

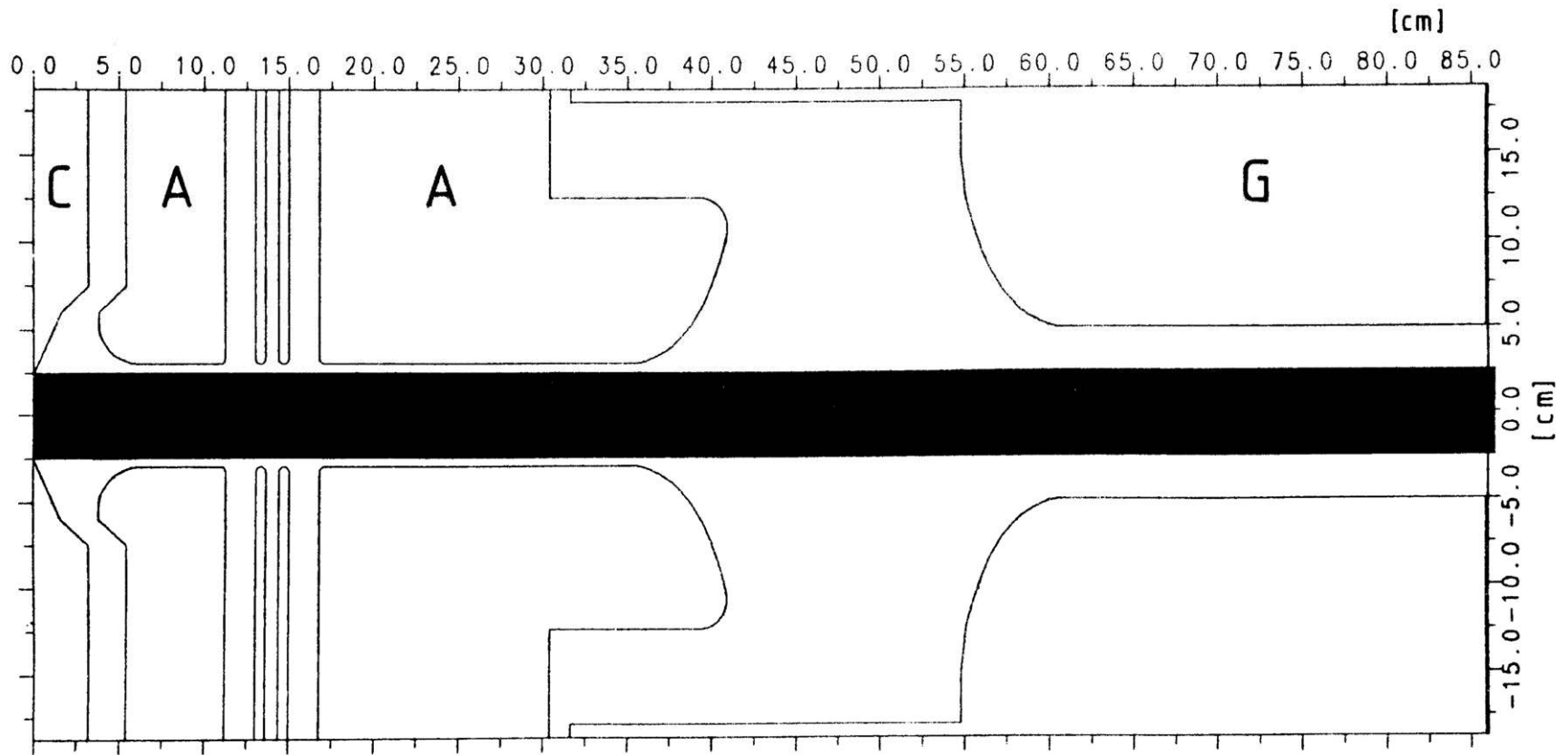

BEAM FORMATION

transverse energy as function of longitudinal position for a 50 keV, 10 A electron beam, guided by a solenoid field with a symmetry error of 10^{-2} over a length of 30 cm.

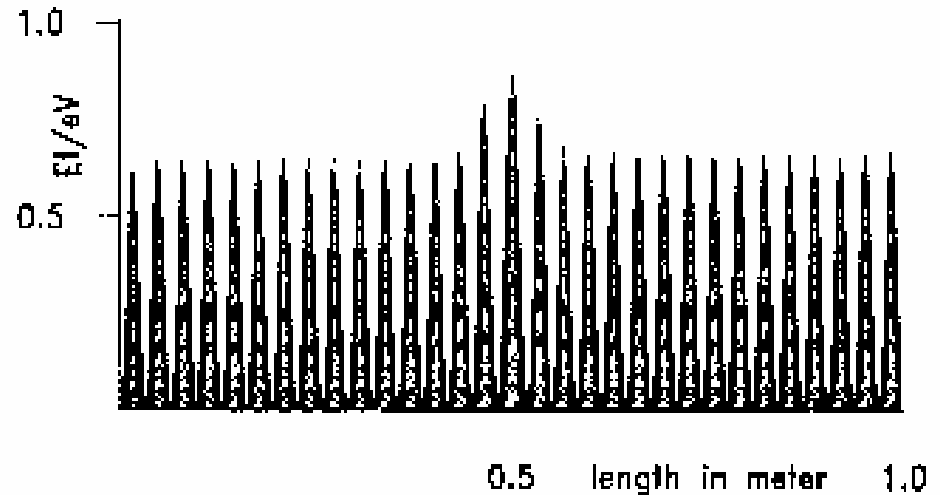

because of the magnetic field the transverse emittance is not constant!

BEAM FORMATION

transverse energy as function of beam energy and applied magnetic field for two different post acceleration geometries:

- single gap acceleration gap
- multi gap acceleration gap

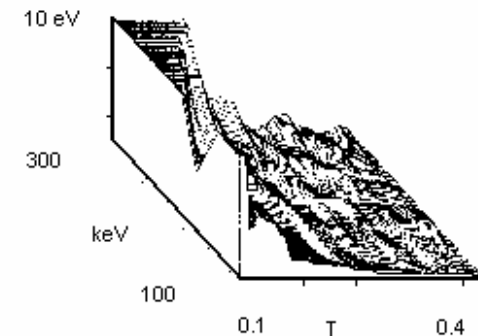
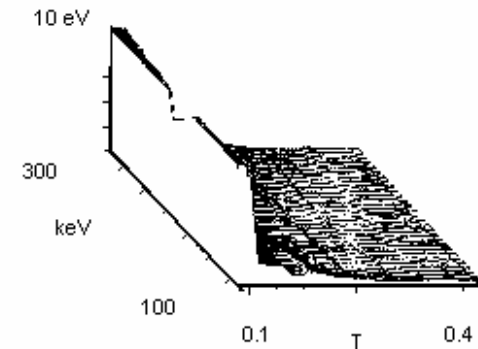

BEAM FORMATION

Collector to dump the electron beam at lowest possible cathode-collector voltage, but with highest possible efficiency.

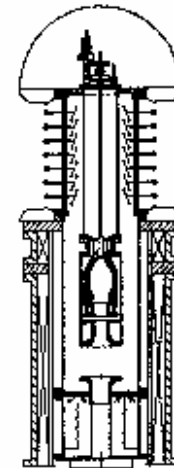
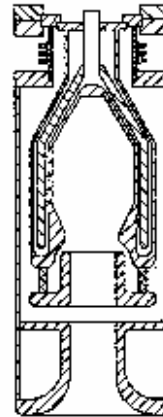
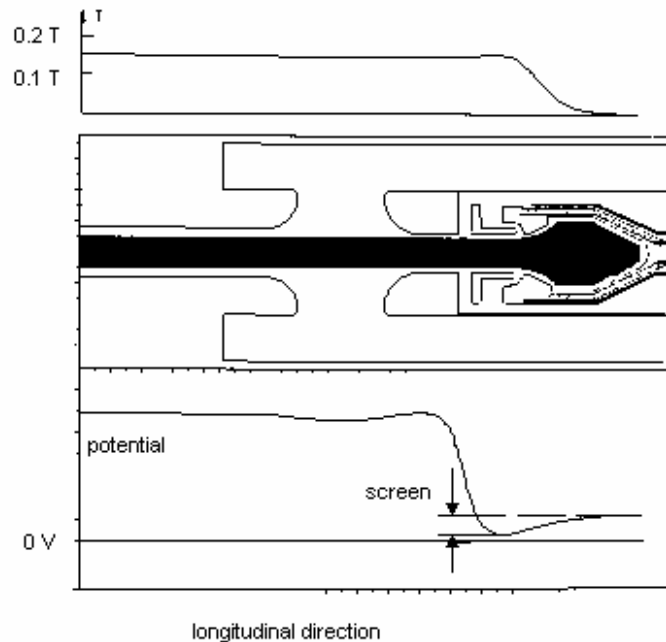

BEAM FORMATION

A similar setup of electron gun and collector is used in most of rf-power tubes, such as klystrons and gyrotrons.

work function



cathodes



cooler



go back to ...

Ion generators

- MUCIS
- Mevva ion source
- PIG ion source

GENERAL

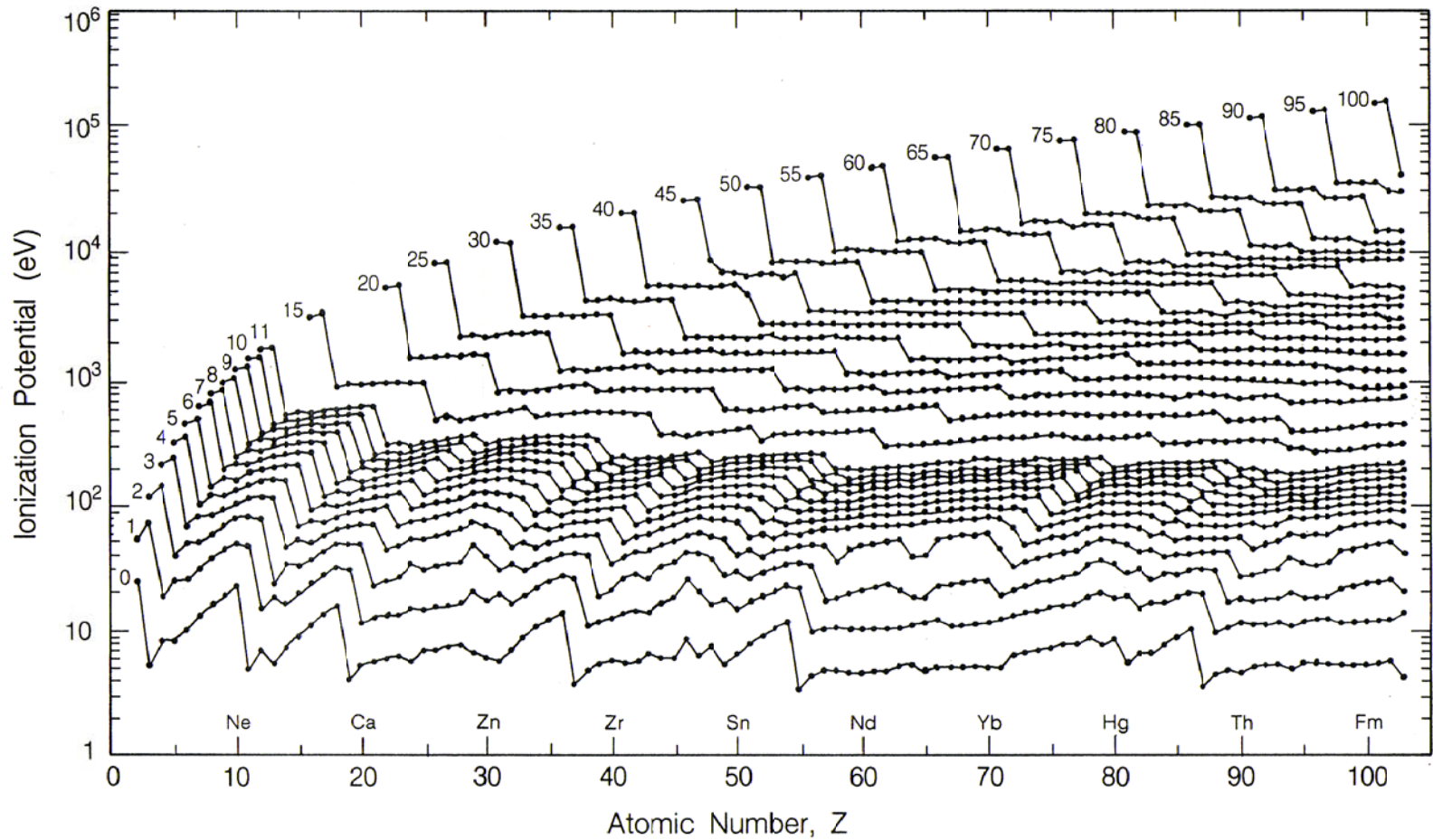

BEAM FORMATION

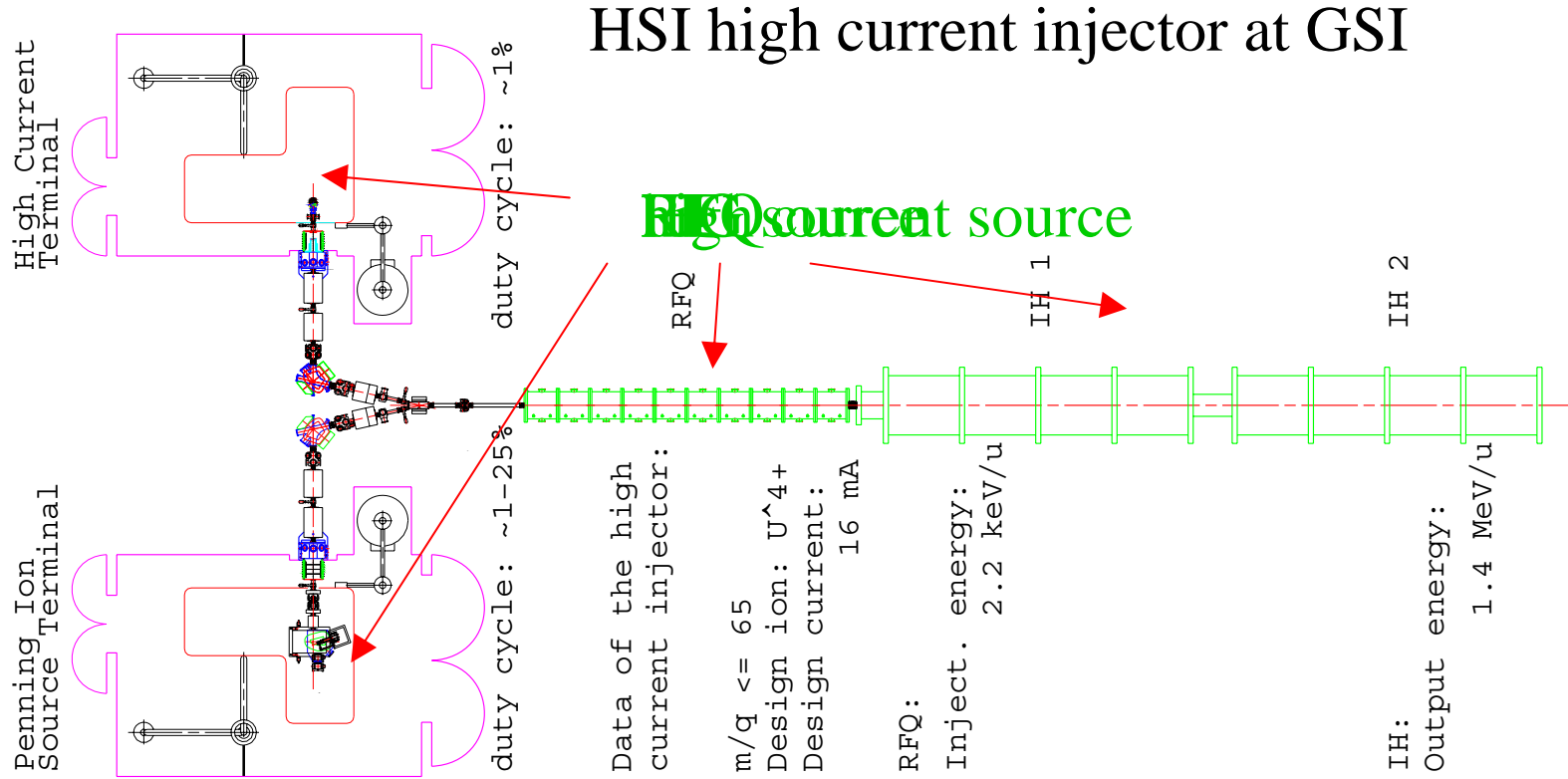

Beamline

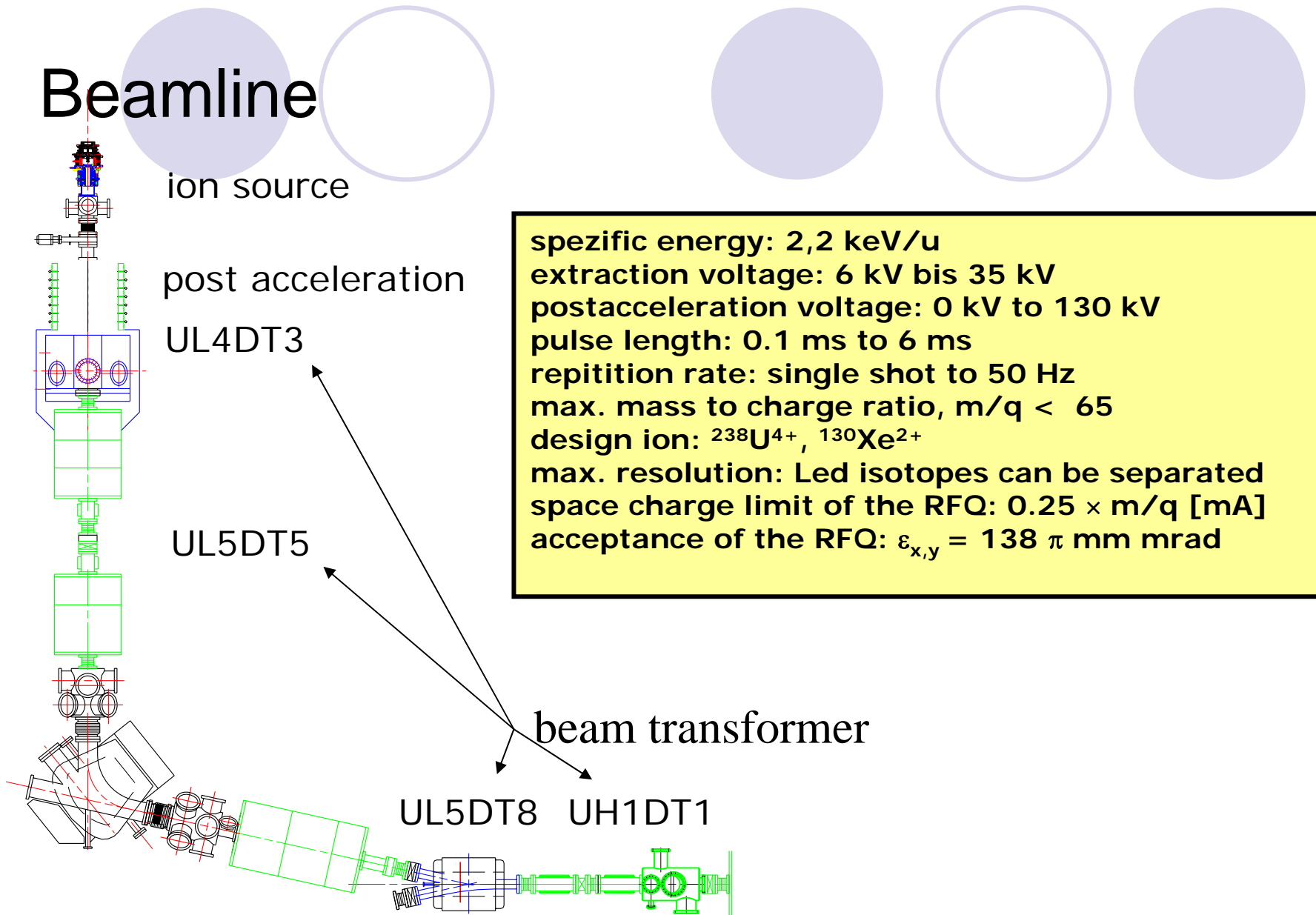

ion source

post acceleration

UL4DT3

UL5DT5

spezific energy: 2,2 keV/u
extraction voltage: 6 kV bis 35 kV
postacceleration voltage: 0 kV to 130 kV
pulse length: 0.1 ms to 6 ms
repetition rate: single shot to 50 Hz
max. mass to charge ratio, $m/q < 65$
design ion: $^{238}\text{U}^{4+}$, $^{130}\text{Xe}^{2+}$
max. resolution: Led isotopes can be separated
space charge limit of the RFQ: $0.25 \times m/q$ [mA]
acceptance of the RFQ: $\varepsilon_{x,y} = 138 \pi$ mm mrad

beam transformer

UL5DT8 UH1DT1



High current ion sources at GSI:

- MUCIS MUlti Charge Ion Source
- MEVVA MEtal Vapor Vacuum Arc

medium current ion source at GSI

- PIG ion source Penning Ionization Gauge

low current source

- ECR Electron Cyclotron Resonance

Multi Cusp Ion Source MUCIS

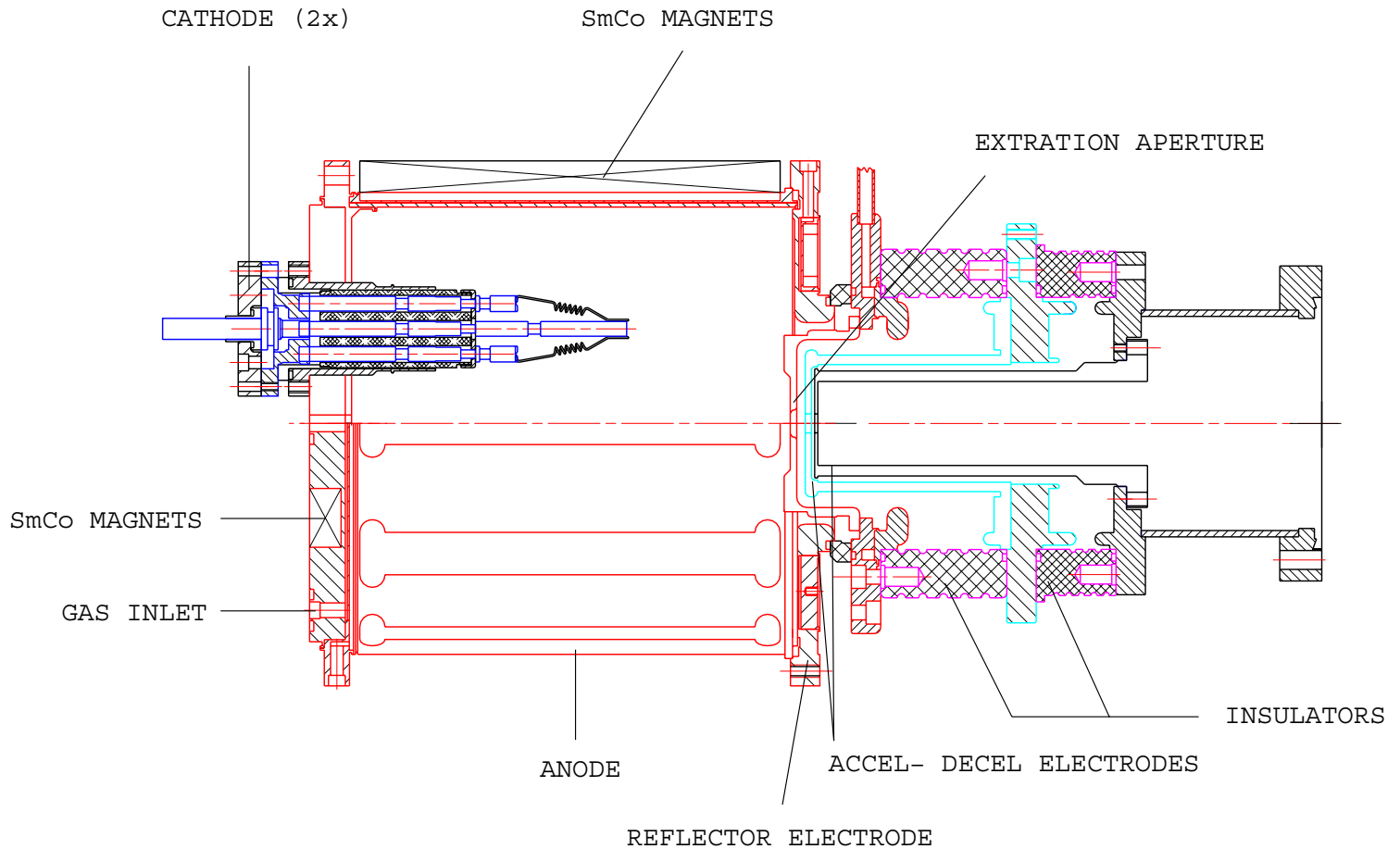

Multi Cusp Ion Source MUCIS

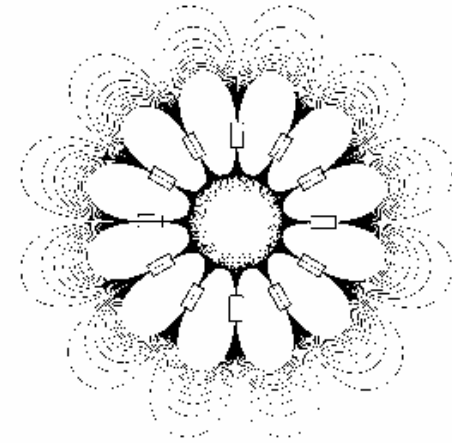
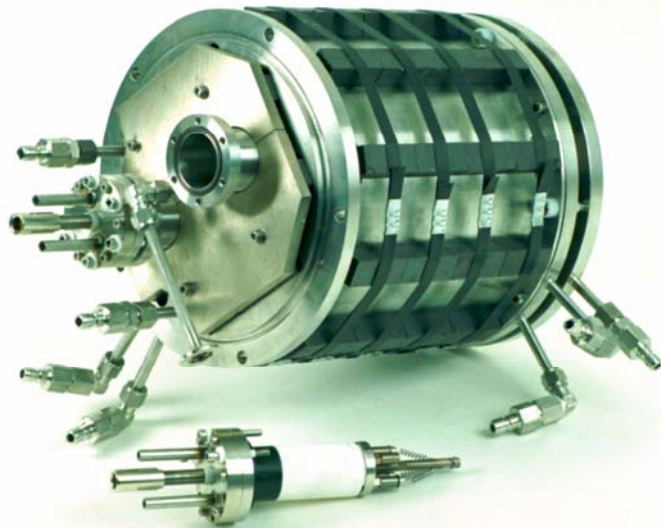

60 CoSm-magnets (2 Tesla)
cathode: 6 filaments. W/Ta
arc power: 30 kW
typical duty cycle: 5 Hz / 1 ms

Multi Cusp Ion Source MUCIS

achieved ion currents from MUCIS
at the entrance of the RFQ with 2.2 keV/u

ion	RFQ sc limit	injector
$^2\text{H}_3^+$	1,5 mA	2.5 mA
$^{14}\text{N}^+$	3,5 mA	4 mA
$^{14}\text{N}_2^+$	7 mA	3 mA
$^{18}\text{O}_2^+$	9 mA	5 mA
$^{20}\text{Ne}^+$	5 mA	5.5 mA
$^{40}\text{Ar}^+$	10 mA	20 mA

Metal Vapor Vacuum Arc Ion Source MEVVA

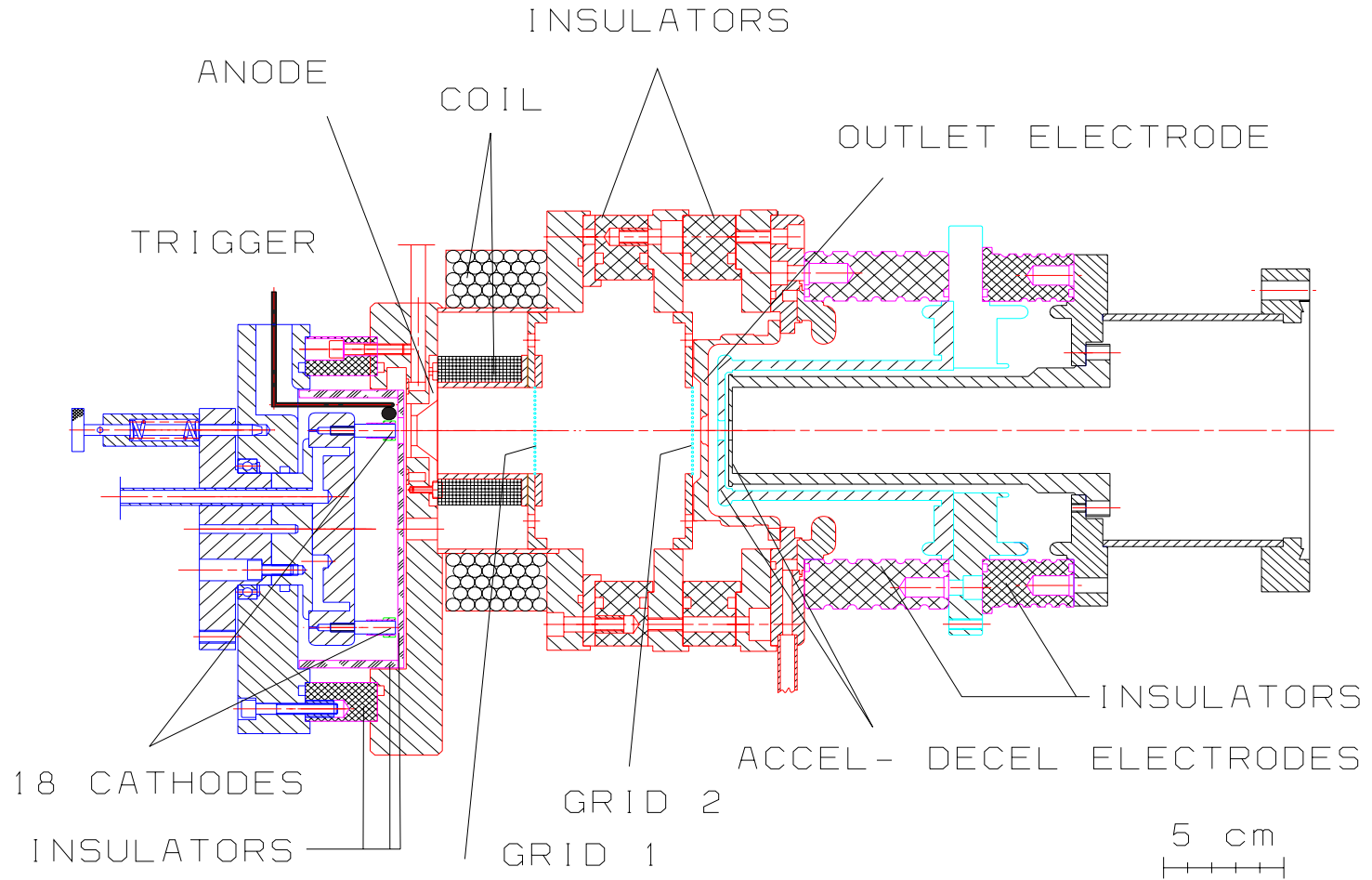

MEVVA IV

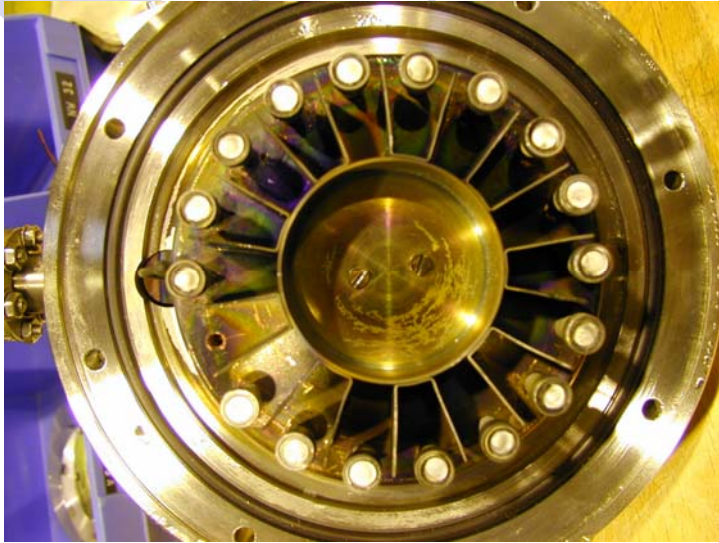

17 cathodes
2 solenoids (0.1 and 0.2 Tesla)
arc power: 50 kW (13,3 MW/cm²)
arc current: ~1 kA
duty cycle: typical 1 Hz, 1 ms
service interval: 1 week (Uran)

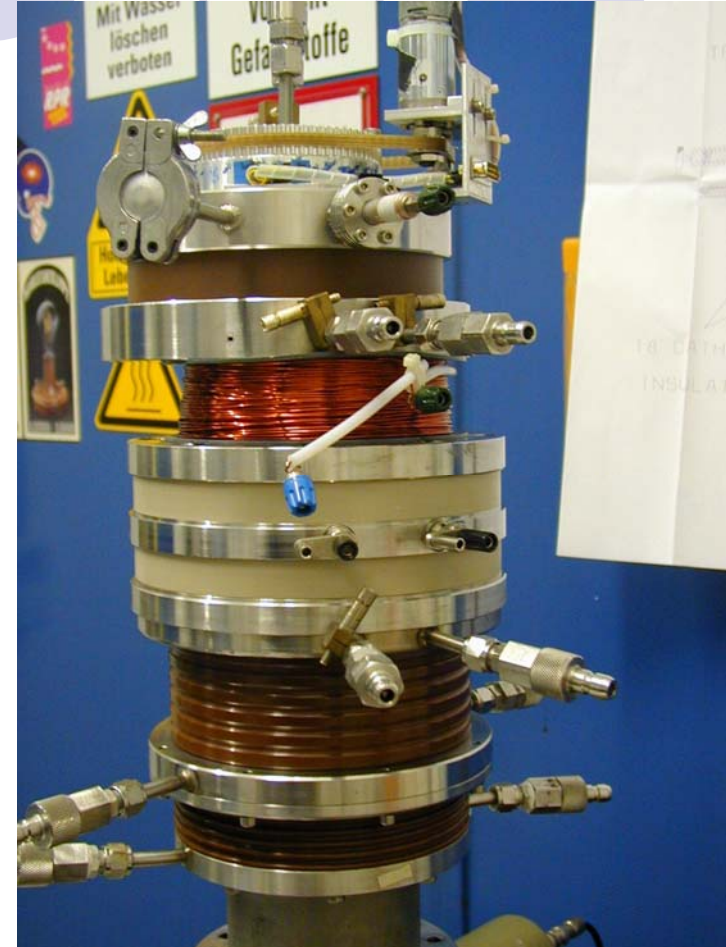

MEVVA IV

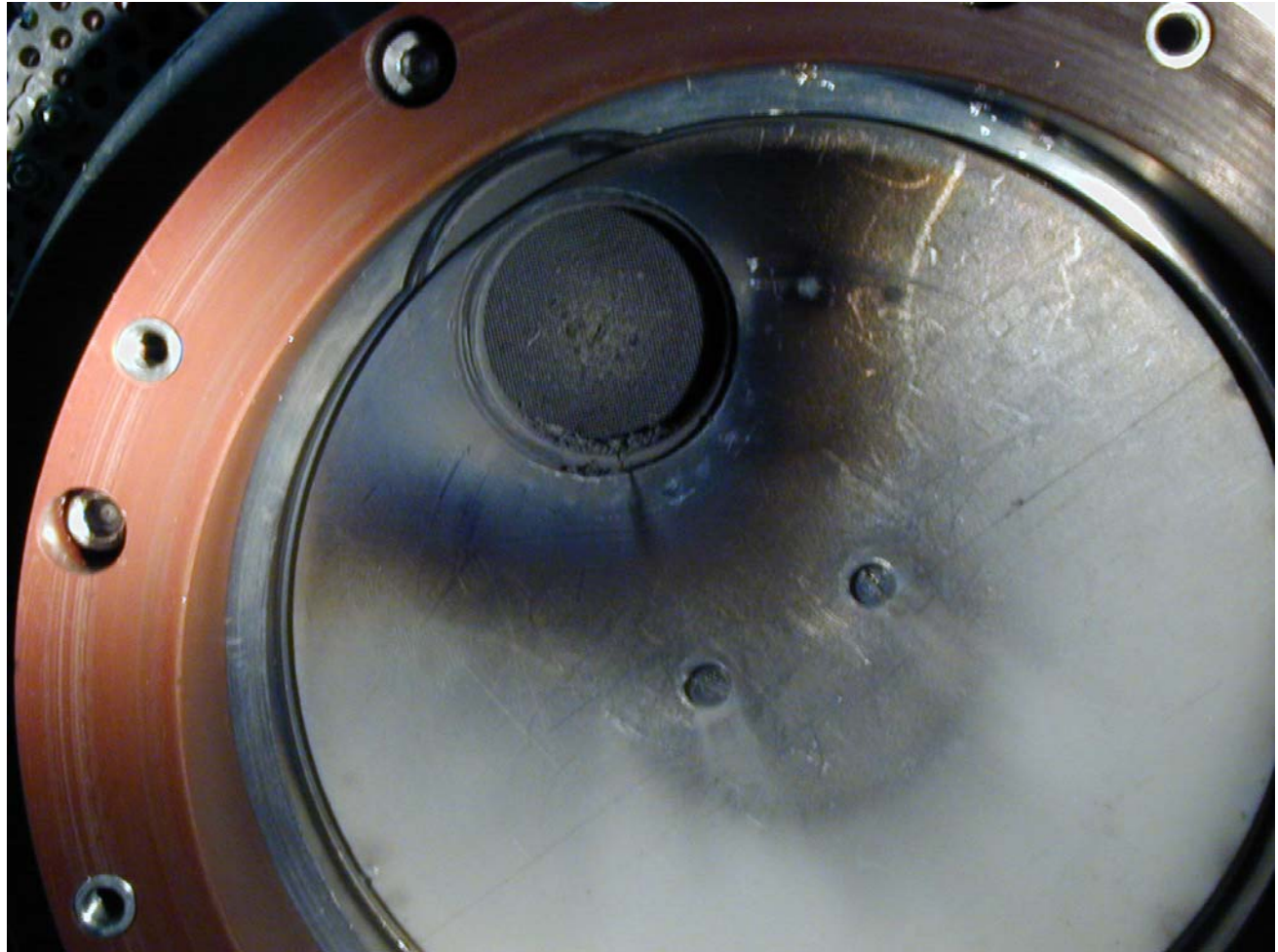

charge state distribution

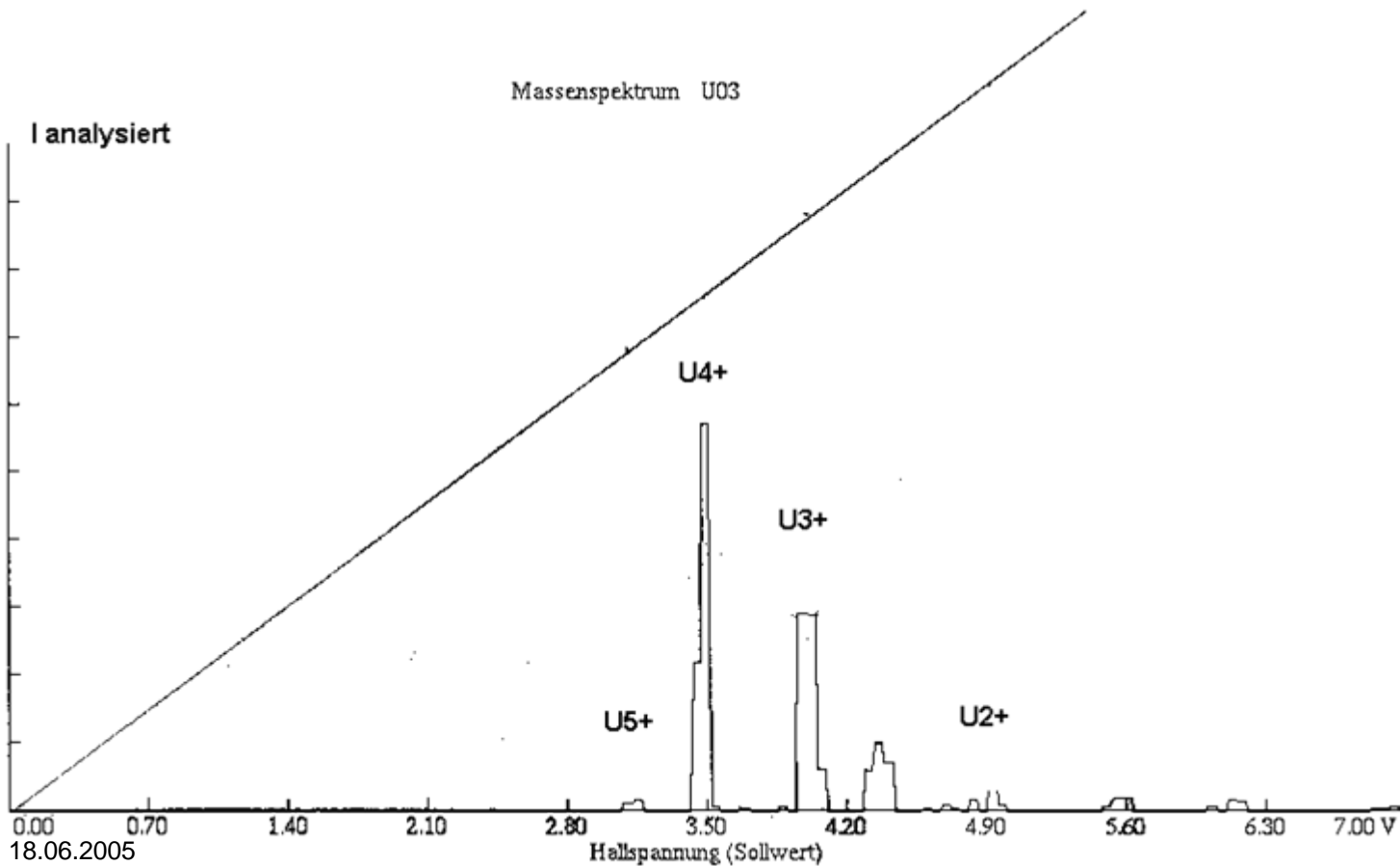

MEVVA IV

achieved currents

ion	design	injector	testbench
$^{12}\text{C}^+$	3 mA	7 mA	
$^{24}\text{Mg}^+$	6 mA		20 mA
$^{24}\text{Mg}^{2+}$	3 mA		70 mA
$^{48}\text{Ti}^+$	12 mA	3 mA	
$^{48}\text{Ti}^{2+}$	6 mA	20 mA	35 mA
$^{48}\text{Ti}^{3+}$	4 mA	20 mA	35 mA
$^{52}\text{Cr}^+$	13 mA	6 mA	
$^{58}\text{Ni}^+$	14,5 mA	10 mA	
$^{58}\text{Ni}^{2+}$	7,25 mA	5 mA	35 mA
$^{92}\text{Mo}^{2+}$	11,5 mA	6 mA	
$^{238}\text{U}^{4+}$	15 mA	20 mA	30 mA

MEVVA IV

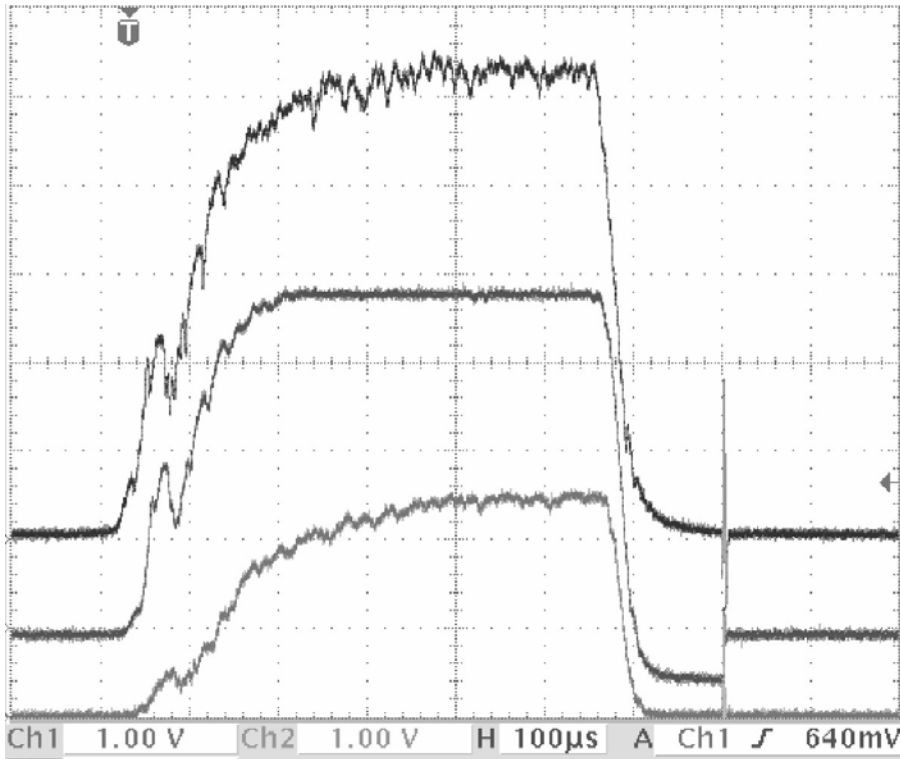
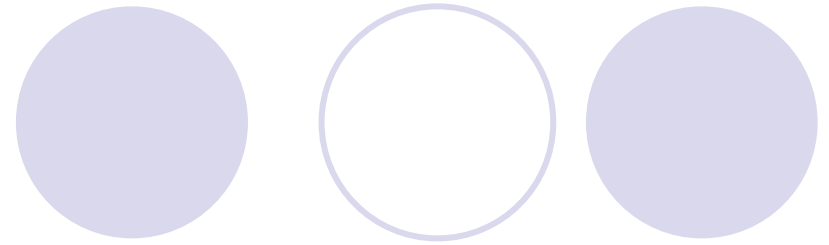

UL4DT3: 10 mA / div (~ 55 mA)

UL5DT5: 10 mA / div (> 40 mA)

UL5DT8: 10 mA /div (~ 25 mA)

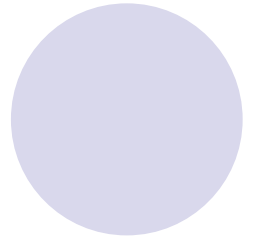
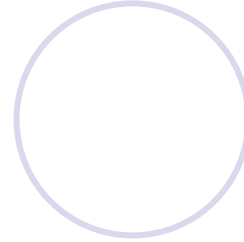
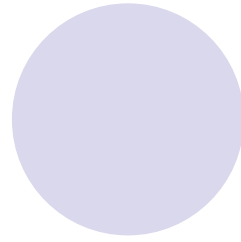
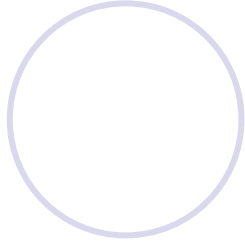
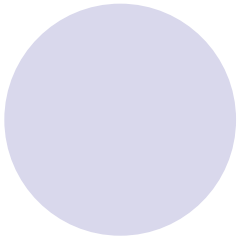

10 mA UL5DT8 7-DEC-2001

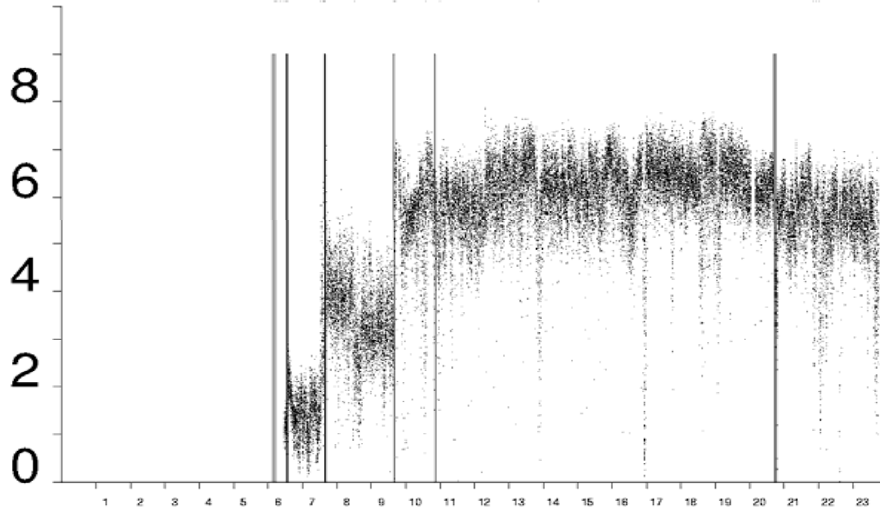

8-DEC-2001

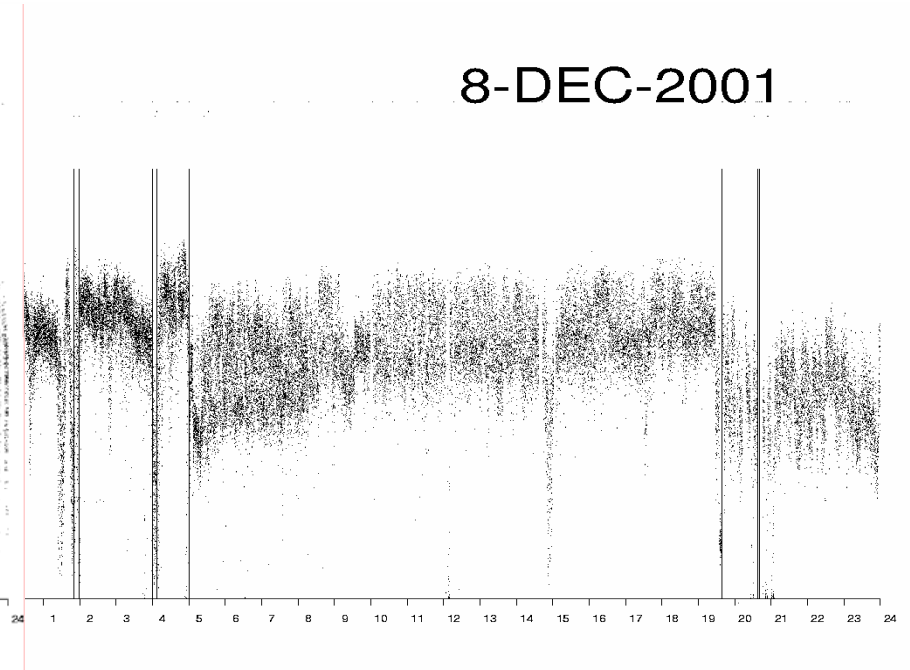

long time stability

Simulation of the ion beam along the beam line

- **The ion beam has been simulated from extraction from the ion source to the front of the dipole magnet by trajectory tracking.**
- **electric field is more important than gravity to within the extraction system and in the post acceleration.**
- **External electric fields are present only in these two sections.**

External magnetic fields are present in the quadrupole section.

Simulation along the beam line

KOBRA3-INP

Ion: $^{238}\text{U}^{4+}$ mrad

y emittance at 0.120 m

location in longitudinal
direction

U_{ex} 30 kV

U_{acc} 100.9 kV

total current

I_{tot} 25 mA

nr of rays 3672
shown here 3348
duration 0.0552 A
within 0.0515 A

extraction

drift

acceleration

drift

quadrupole

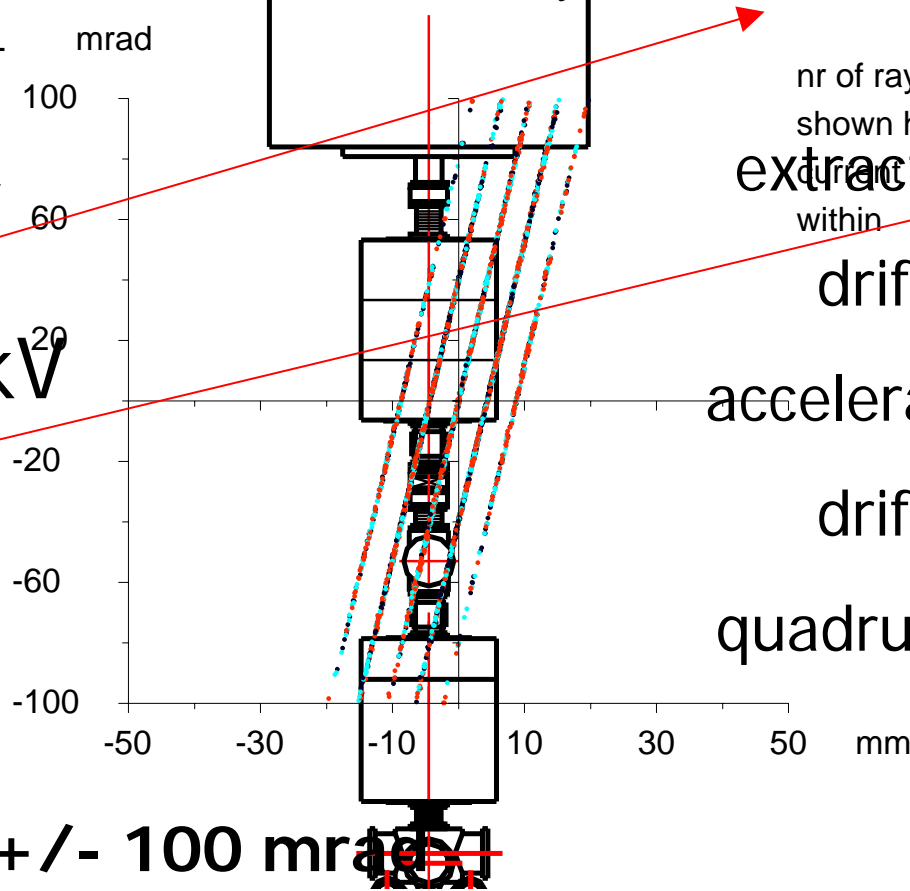

Y-emittance +/- 100 mrad

+/- 50 mm

Fasten seat belt: extraction !!!

KOBRA3-INP

y emittance at 0.004 m

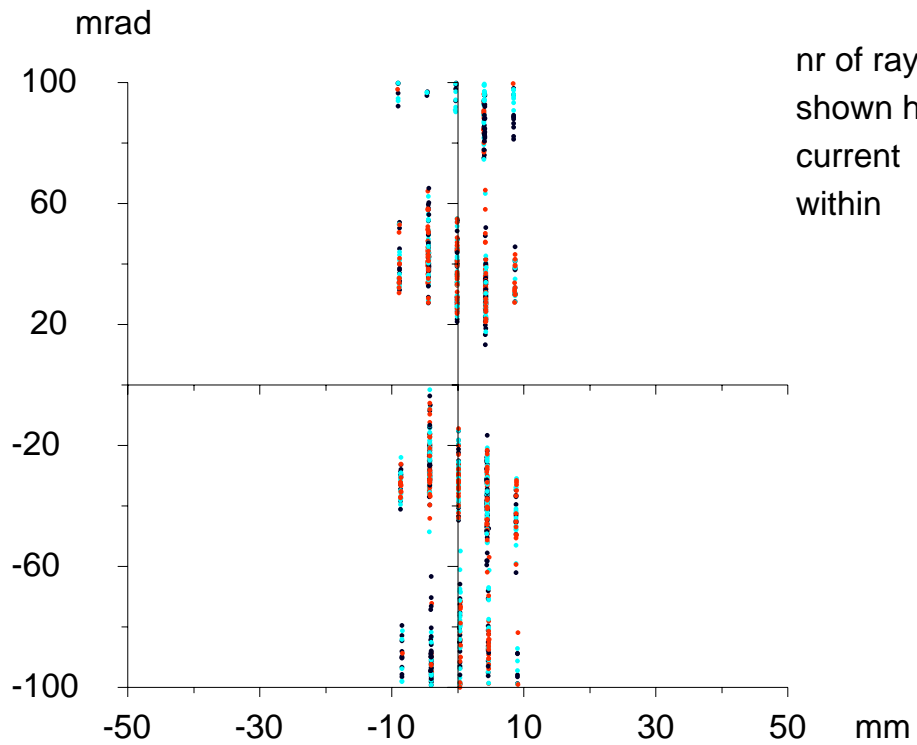

nr of rays	3672
shown here	1135
current	.0552 A
within	.0178 A

Fasten seat belt: extraction !!!

KOBRA3-INP

y emittance at 0.006 m

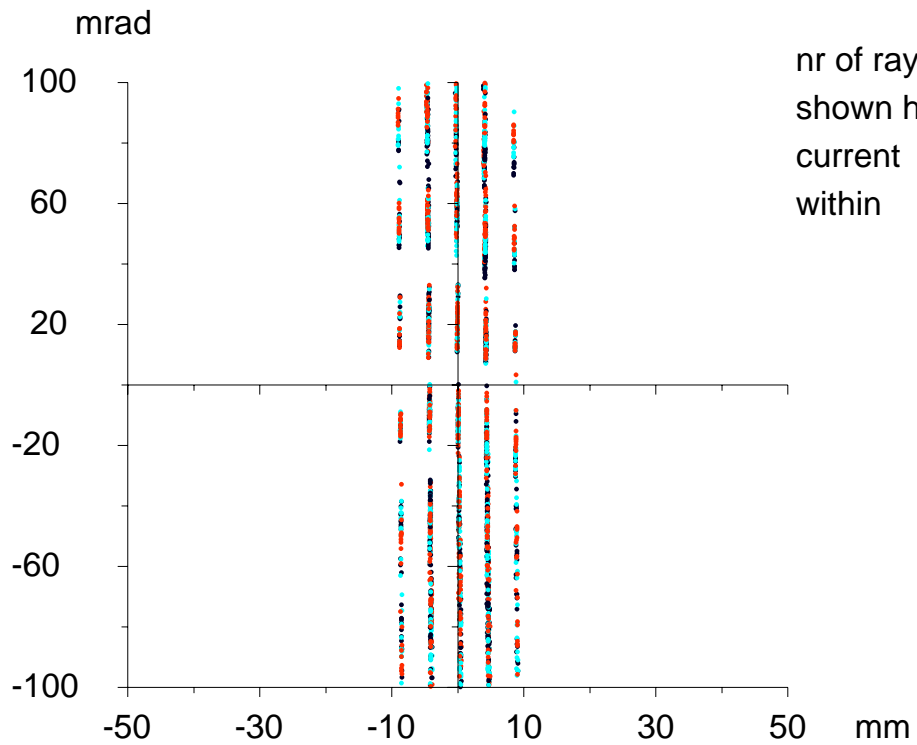

Fasten seat belt: extraction !!!

KOBRA3-INP

y emittance at 0.008 m

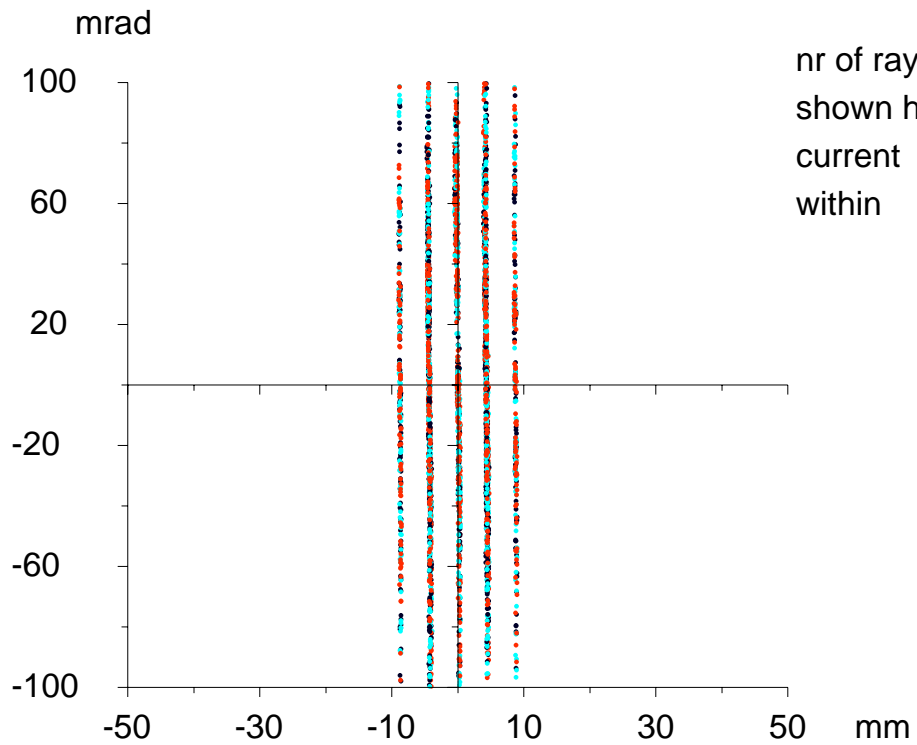

Fasten seat belt: extraction !!!

KOBRA3-INP

y emittance at 0.010 m

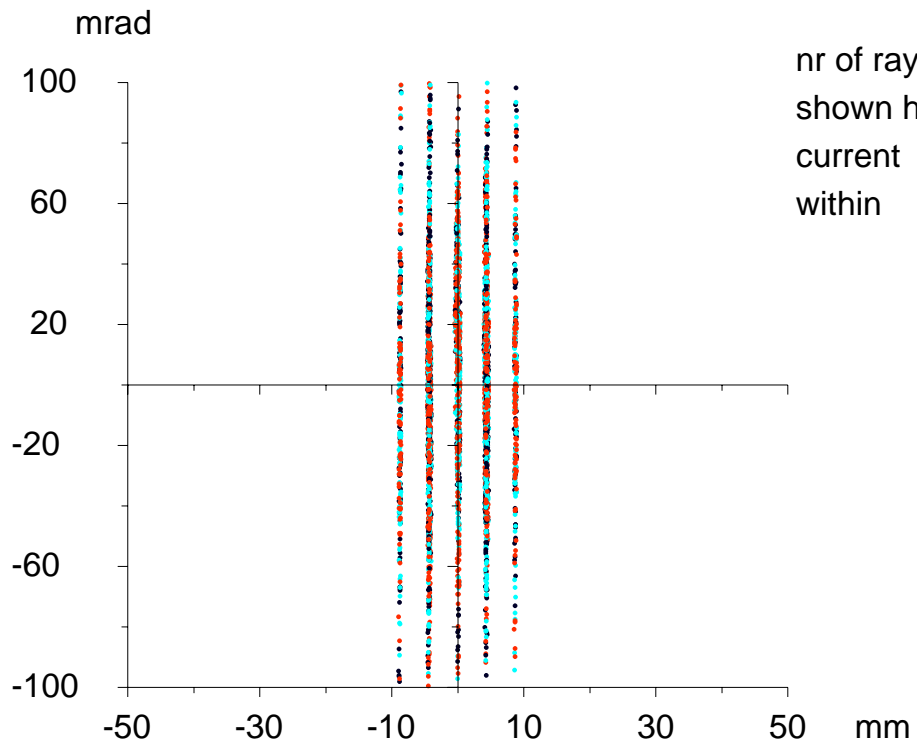

Fasten seat belt: extraction !!!

KOBRA3-INP

y emittance at 0.012 m

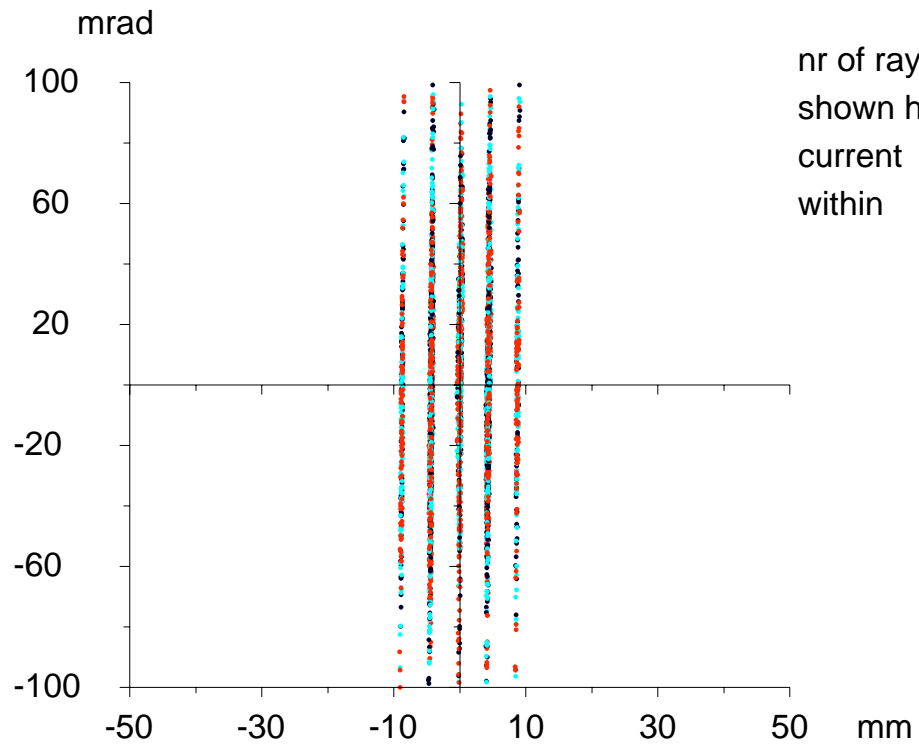

nr of rays	3672
shown here	3456
current	.0552 A
within	.0530 A

Fasten seat belt: extraction !!!

KOBRA3-INP

y emittance at 0.014 m

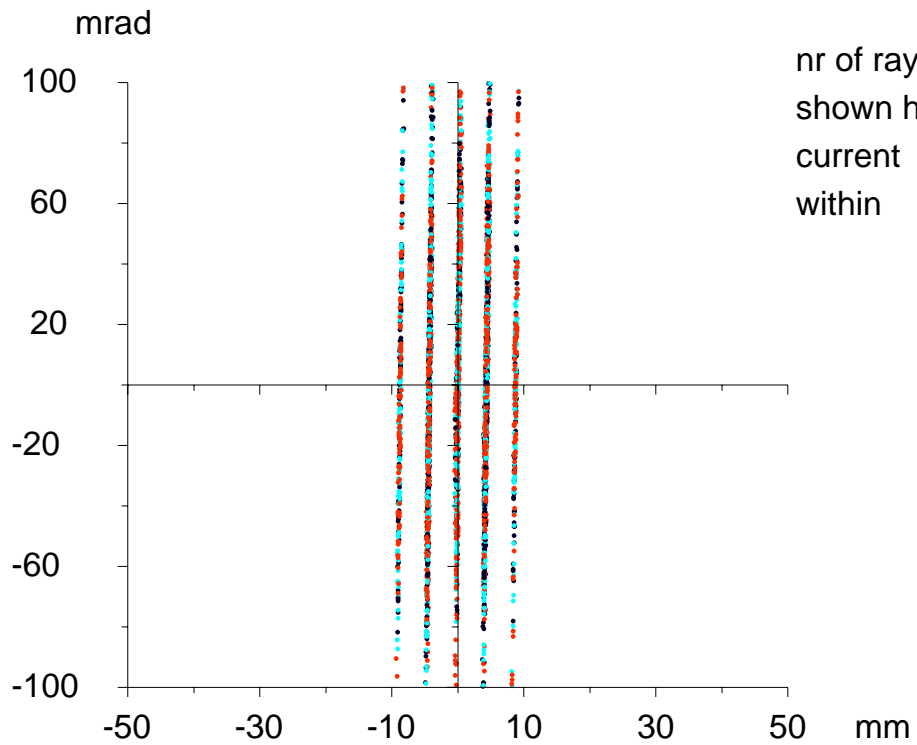

Fasten seat belt: extraction !!!

KOBRA3-INP

y emittance at 0.016 m

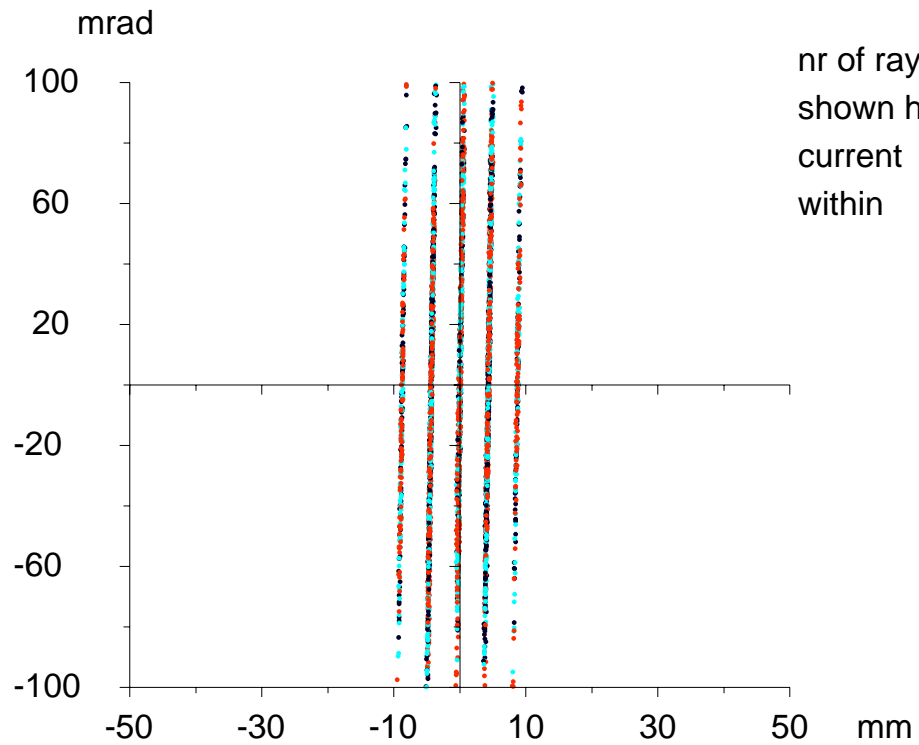

relax and drift

KOBRA3-INP

y emittance at 0.070 m

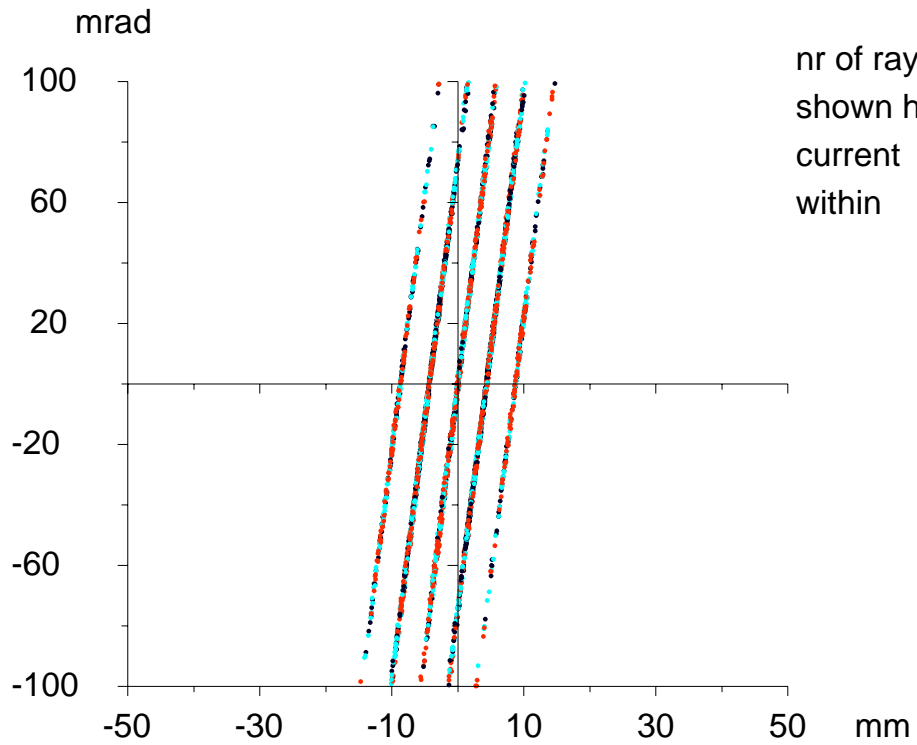

nr of rays	3672
shown here	3348
current	.0552 A
within	.0515 A

relax and drift

KOBRA3-INP

y emittance at 0.120 m

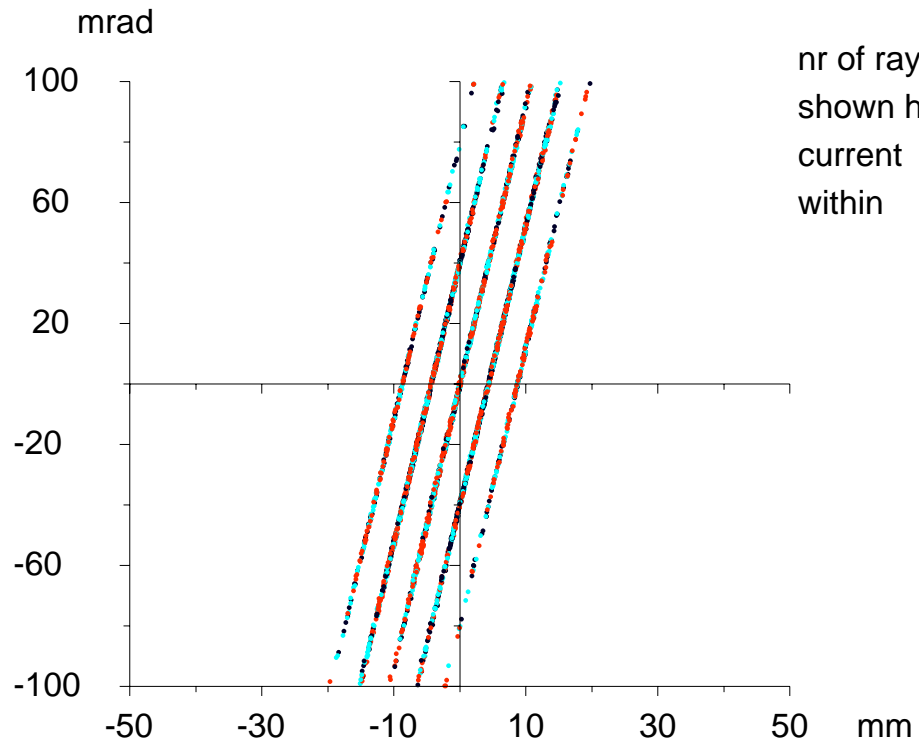

nr of rays	3672
shown here	3348
current	.0552 A
within	.0515 A

relax and drift

KOBRA3-INP

y emittance at 0.170 m

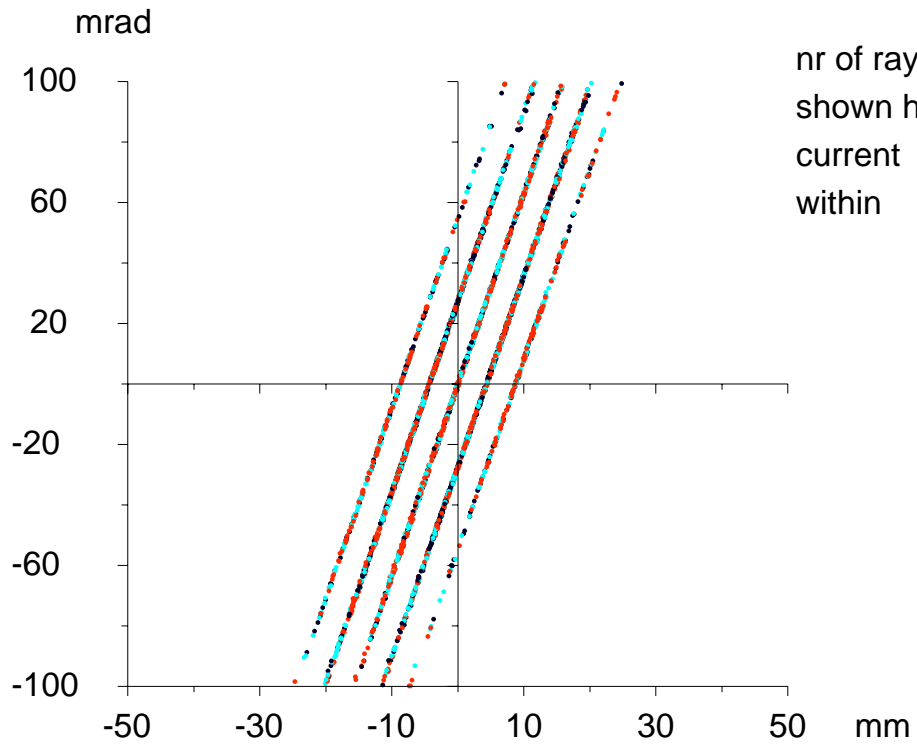

relax and drift

KOBRA3-INP

y emittance at 0.220 m

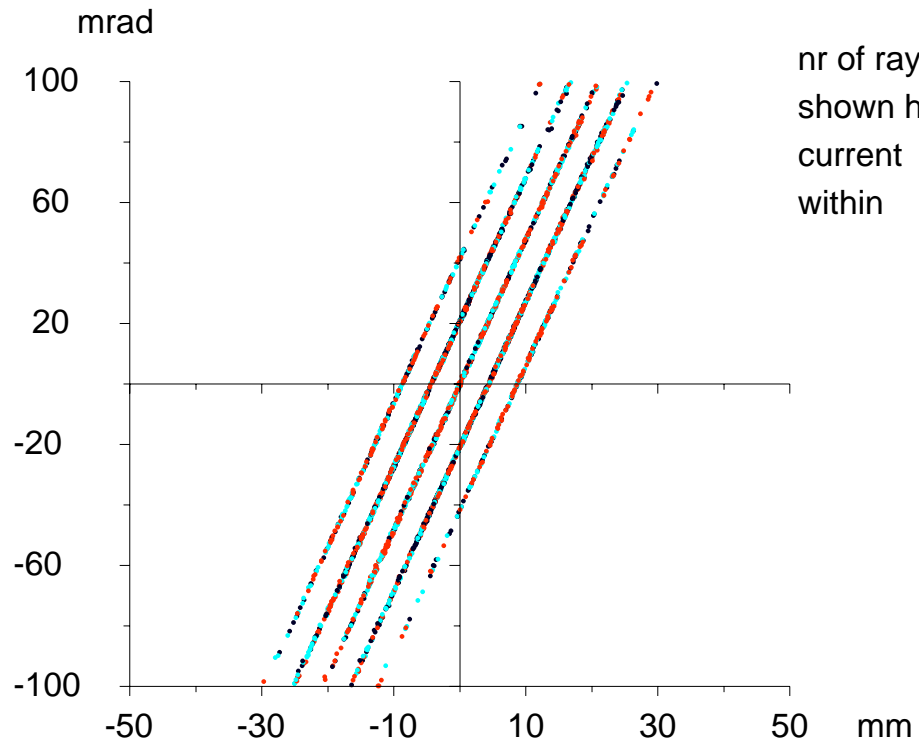

relax and drift

KOBRA3-INP

y emittance at 0.270 m

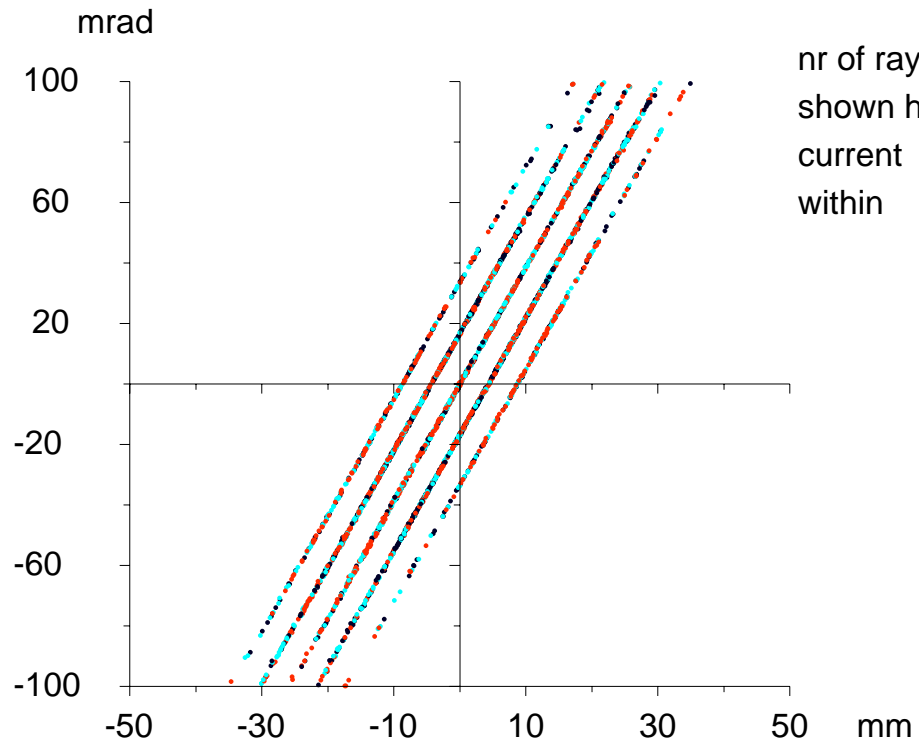

relax and drift

KOBRA3-INP

y emittance at 0.320 m

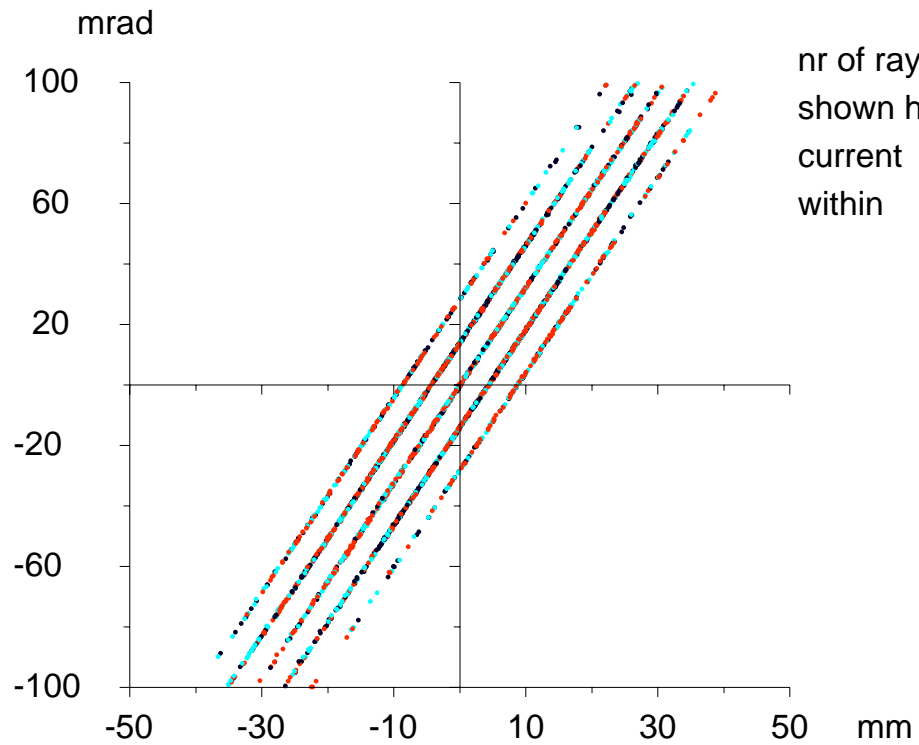

relax and drift

KOBRA3-INP

y emittance at 0.370 m

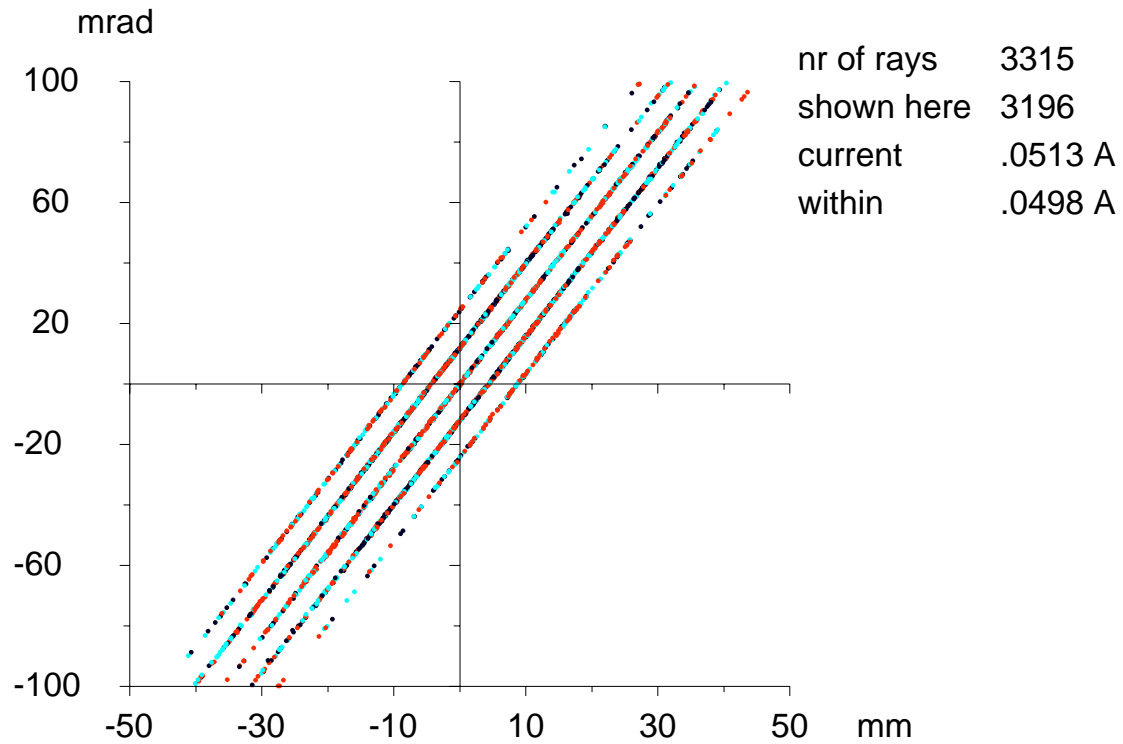

relax and drift

KOBRA3-INP

y emittance at 0.420 m

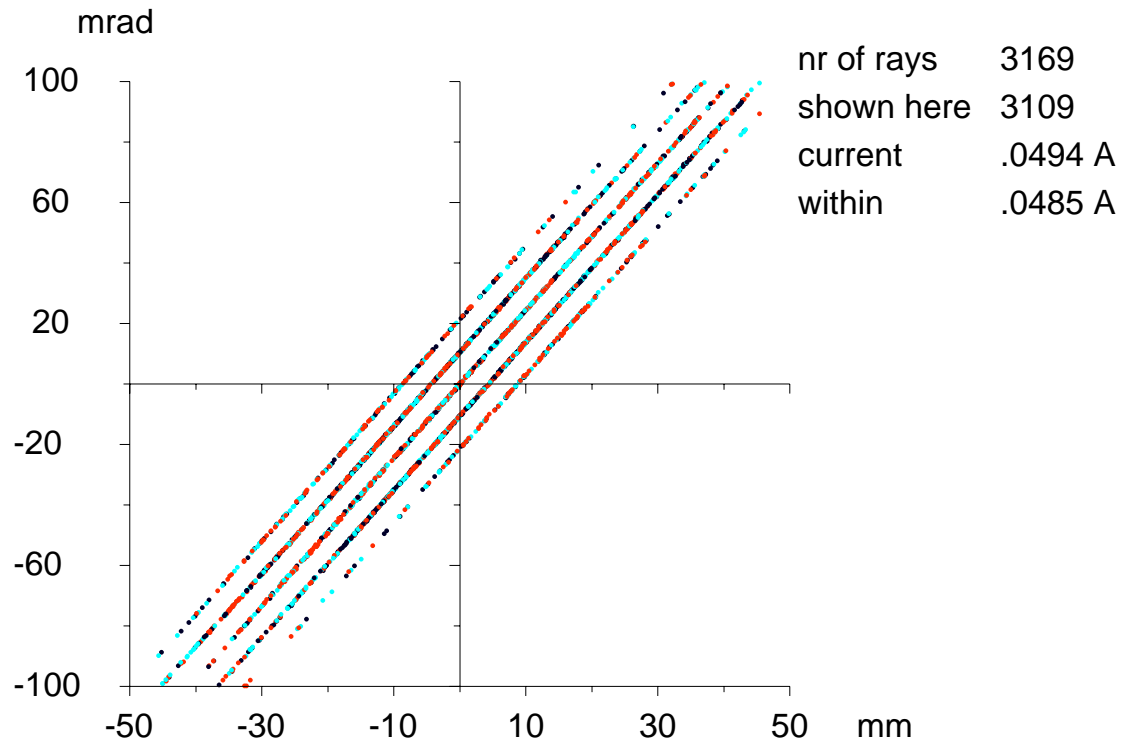

relax and drift

KOBRA3-INP

y emittance at 0.470 m

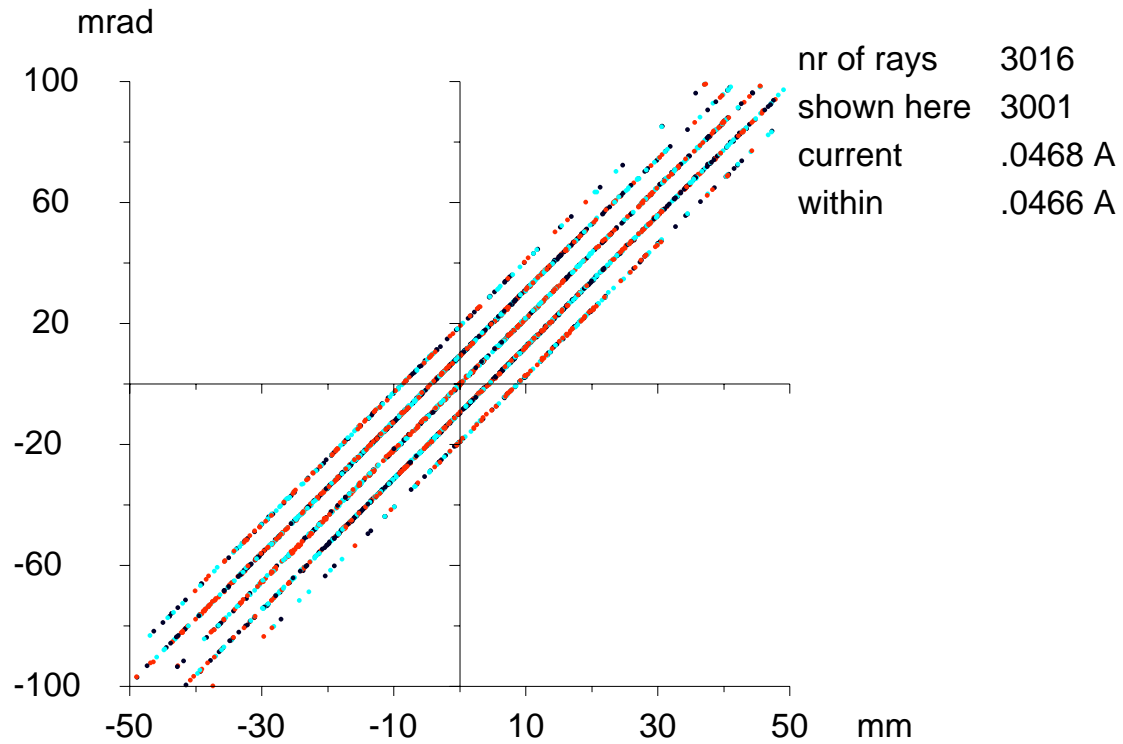

relax and drift

KOBRA3-INP

y emittance at 0.480 m

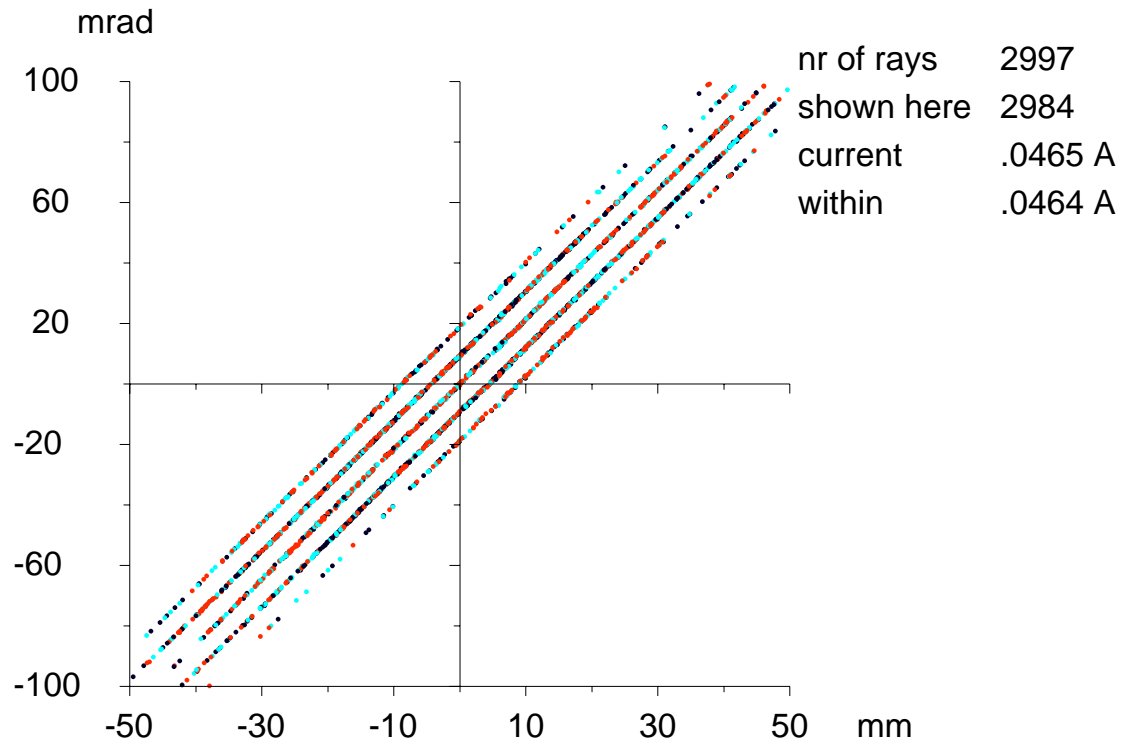

relax and drift

KOBRA3-INP

y emittance at 0.490 m

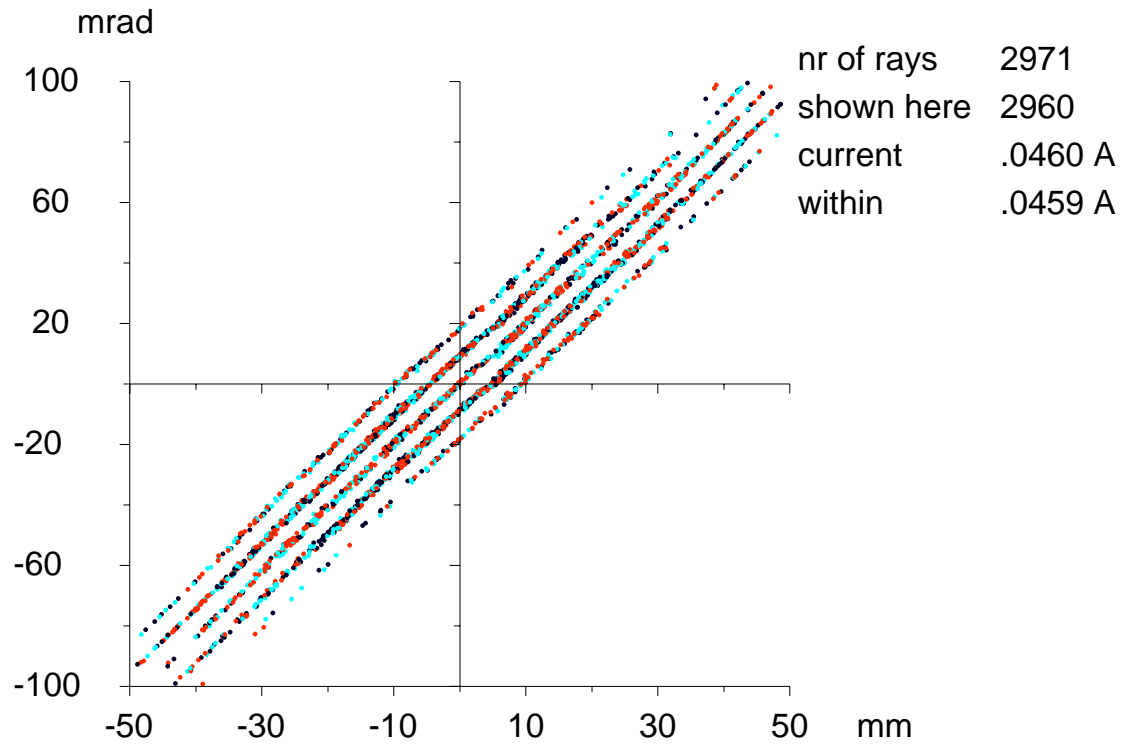

be aware: acceleration

KOBRA3-INP

y emittance at 0.500 m

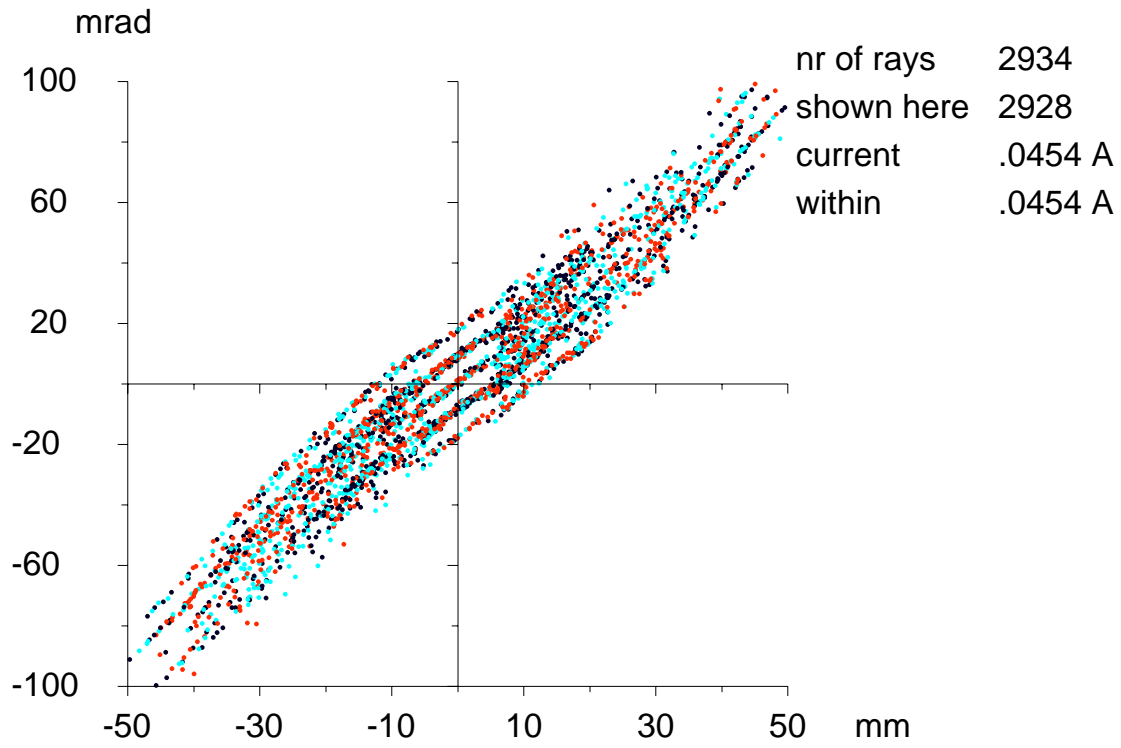

be aware: acceleration

KOBRA3-INP

y emittance at 0.510 m

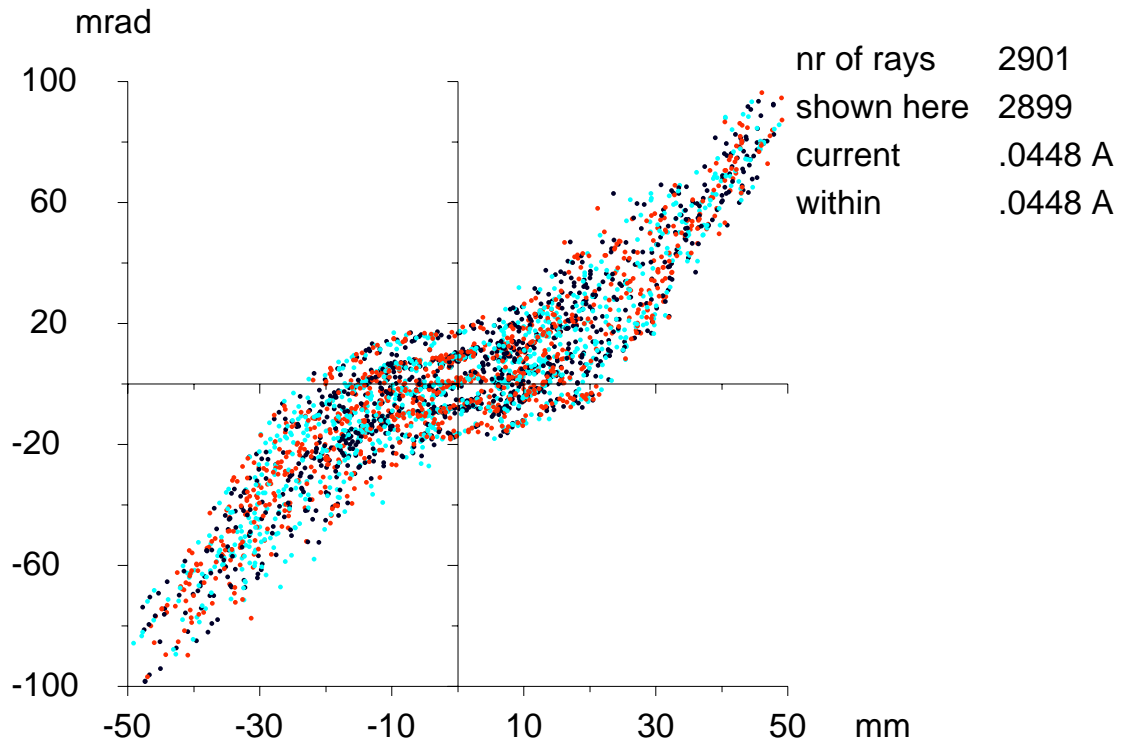

be aware: acceleration

KOBRA3-INP

y emittance at 0.520 m

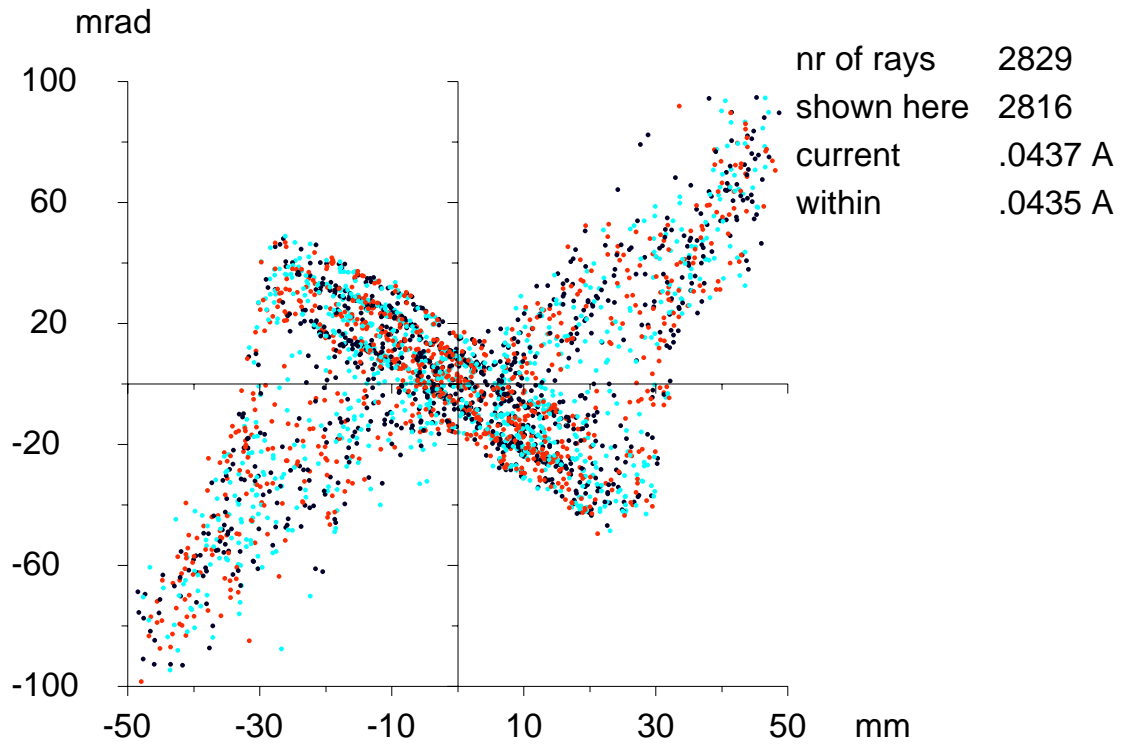

be aware: acceleration

KOBRA3-INP

y emittance at 0.530 m

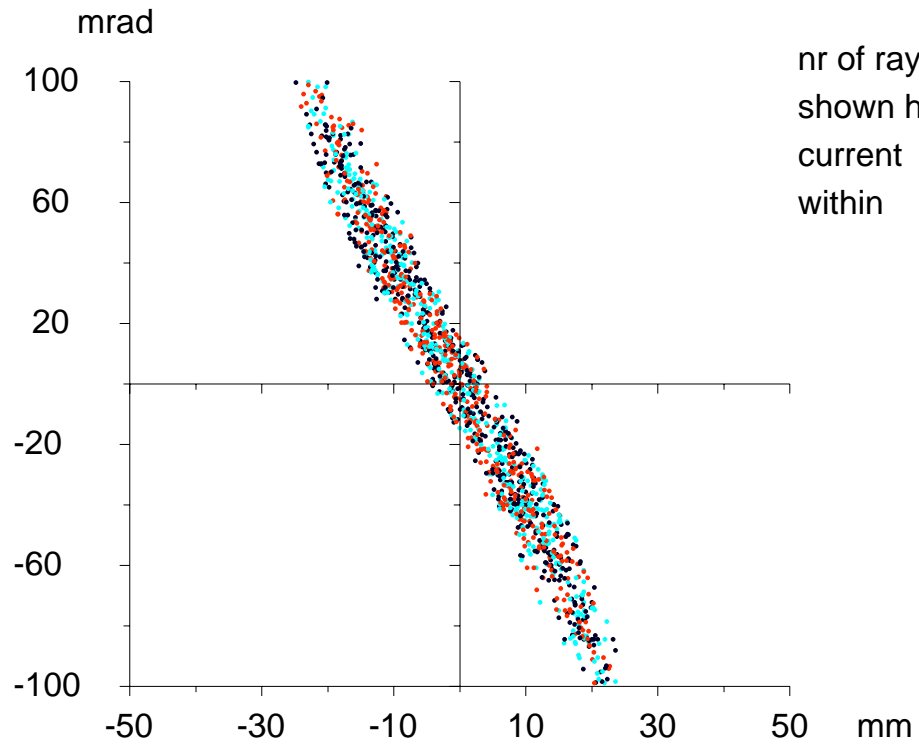

be aware: acceleration

KOBRA3-INP

y emittance at 0.540 m

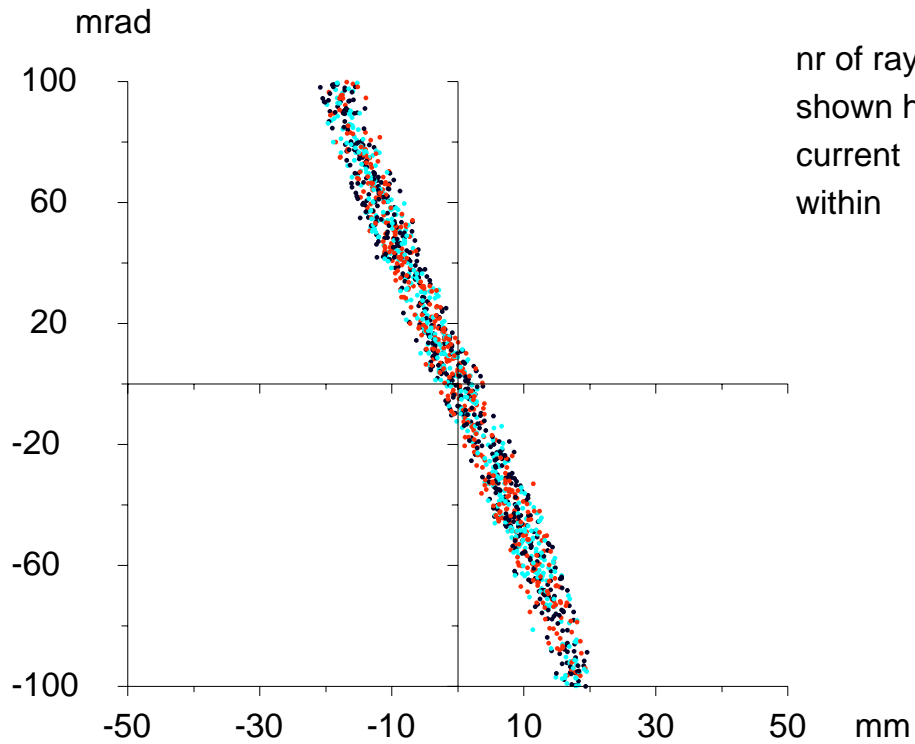

be aware: acceleration

KOBRA3-INP

y emittance at 0.550 m

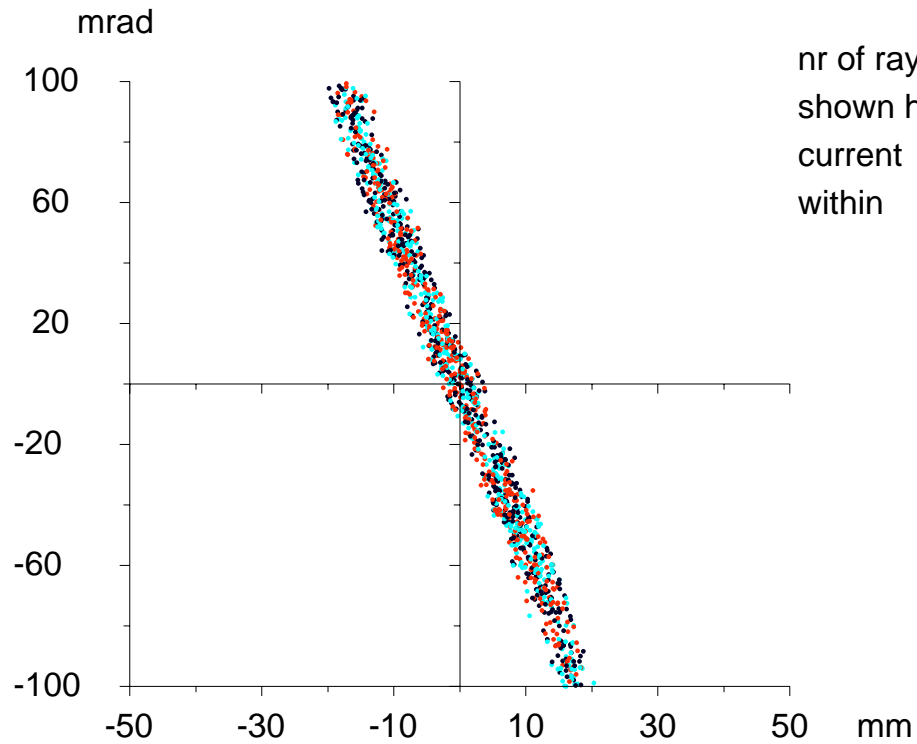

be aware: acceleration

KOBRA3-INP

y emittance at 0.560 m

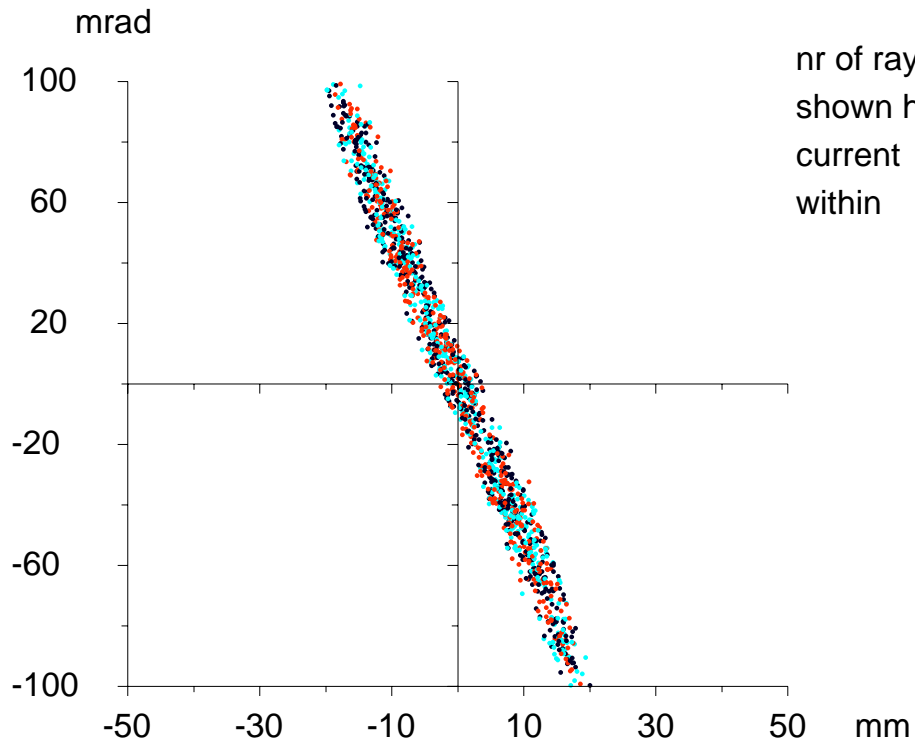

be aware: acceleration

KOBRA3-INP

y emittance at 0.570 m

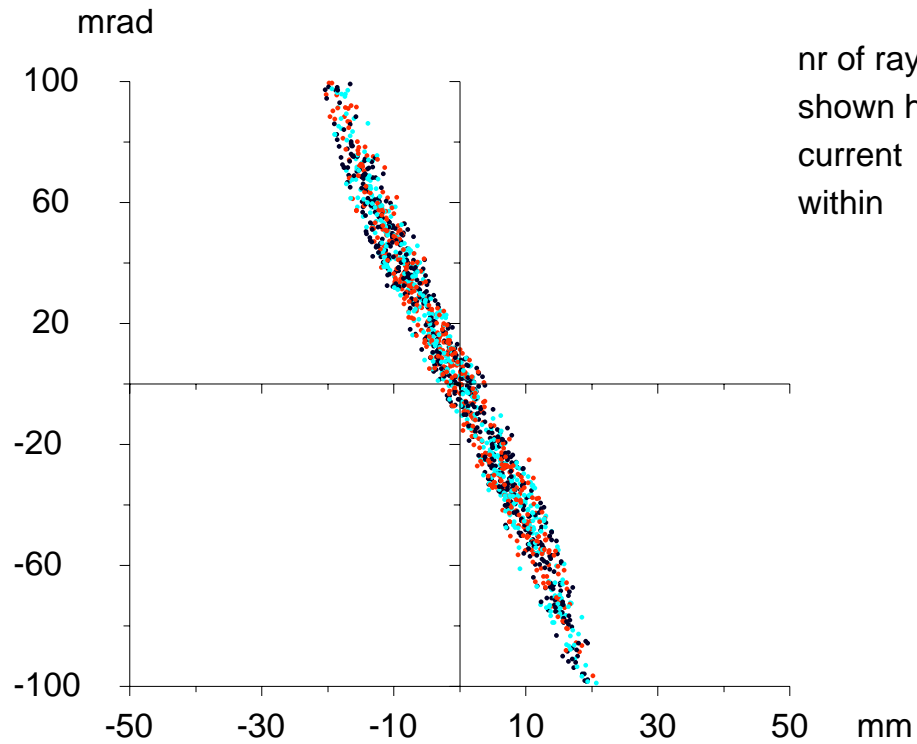

be aware: acceleration

KOBRA3-INP

y emittance at 0.580 m

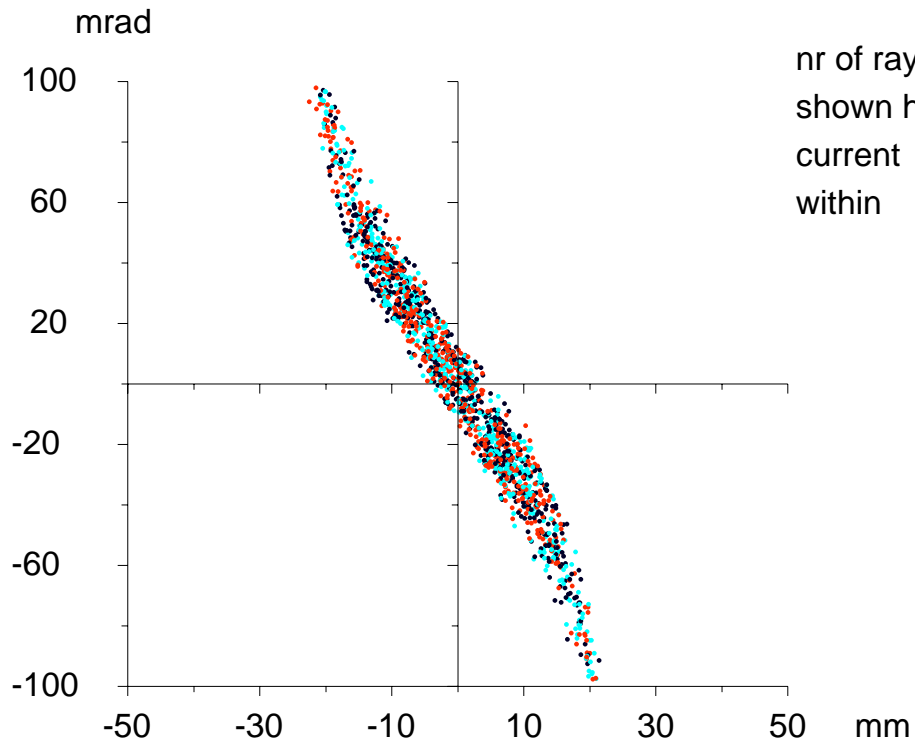

be aware: acceleration

KOBRA3-INP

y emittance at 0.590 m

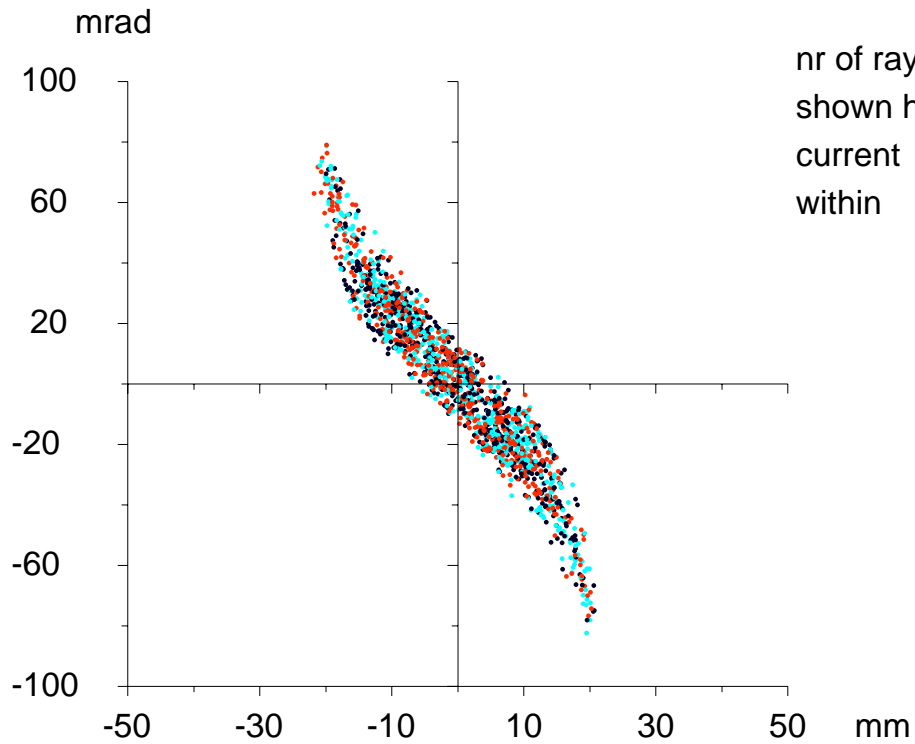

be aware: acceleration

KOBRA3-INP

y emittance at 0.600 m

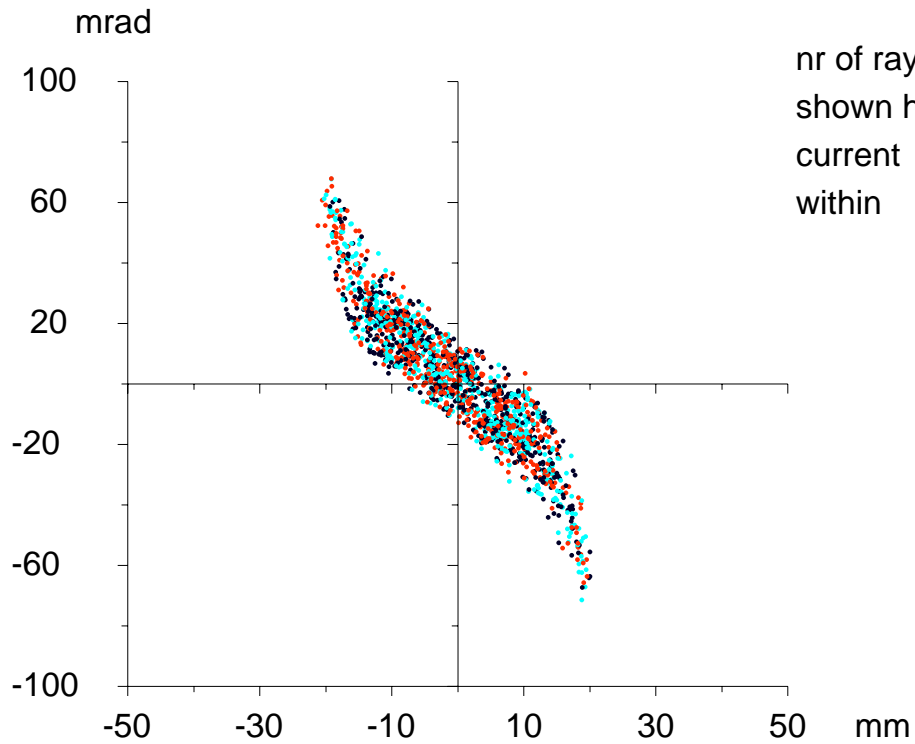

be aware: acceleration

KOBRA3-INP

y emittance at 0.610 m

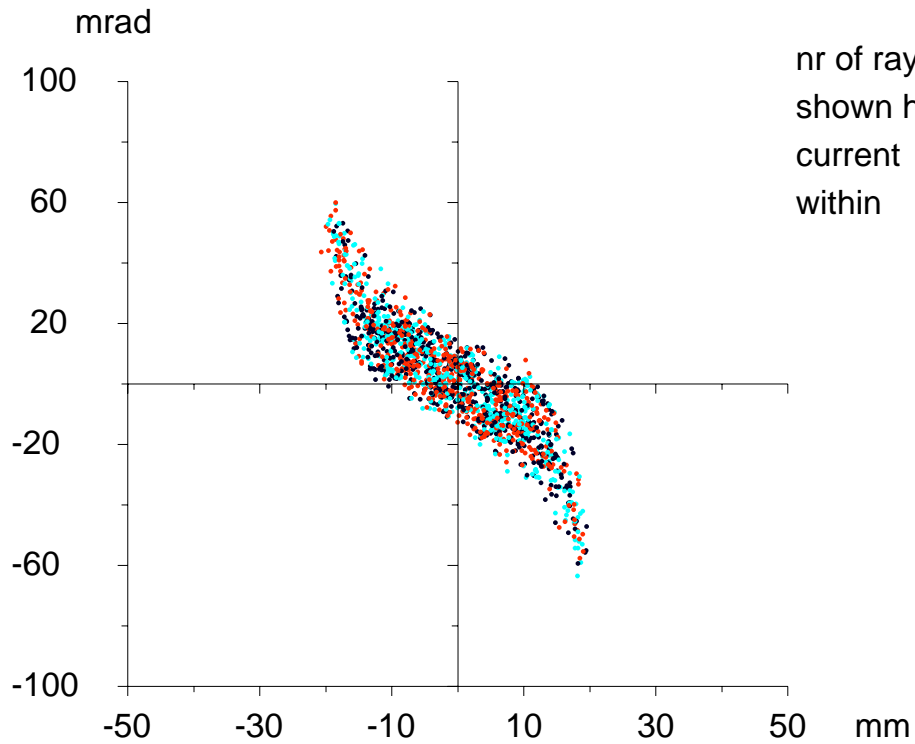

be aware: acceleration

KOBRA3-INP

y emittance at 0.620 m

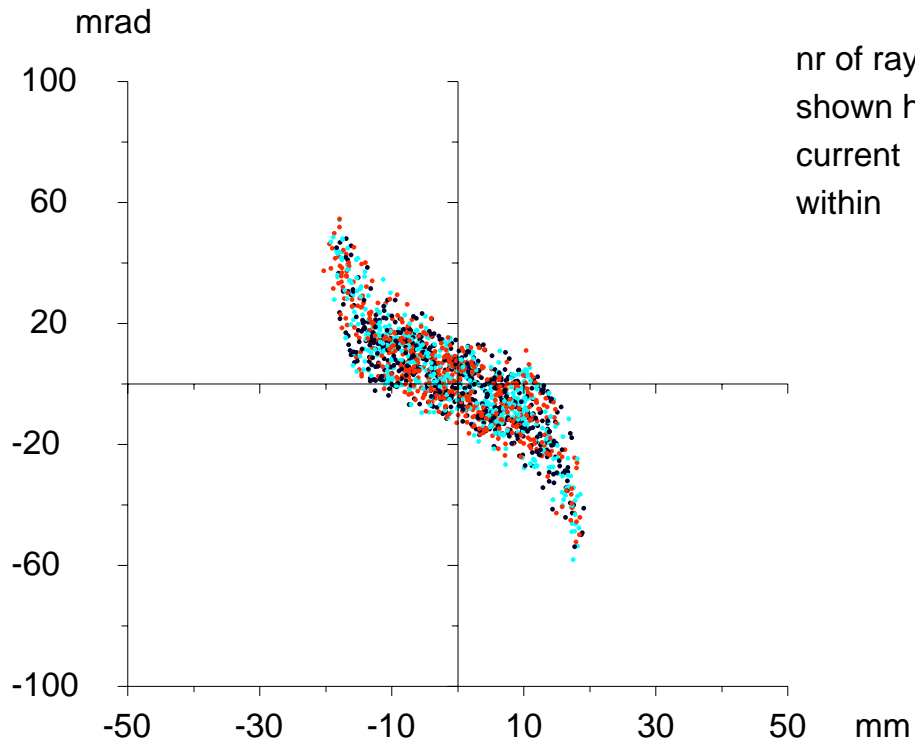

be aware: acceleration

KOBRA3-INP

y emittance at 0.630 m

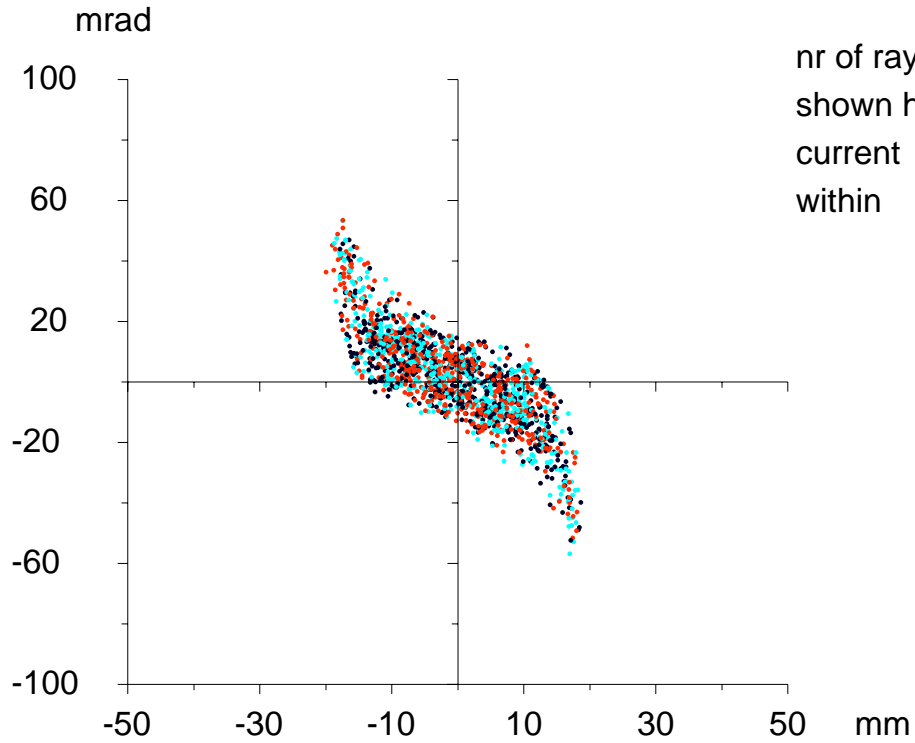

be aware: acceleration

KOBRA3-INP

y emittance at 0.640 m

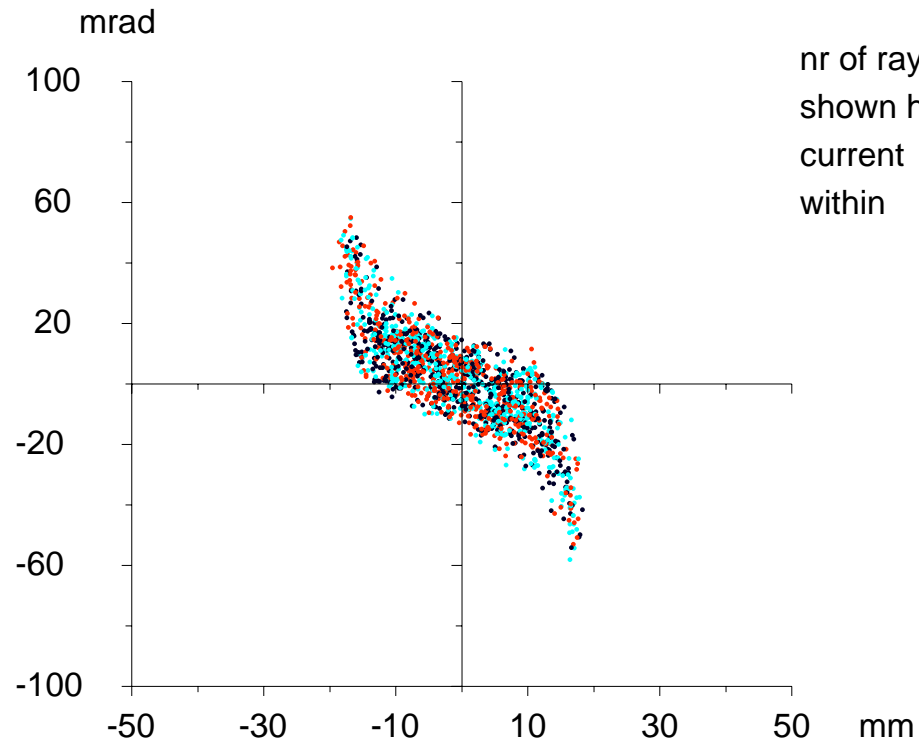

relax and drift

KOBRA3-INP

y emittance at 0.650 m

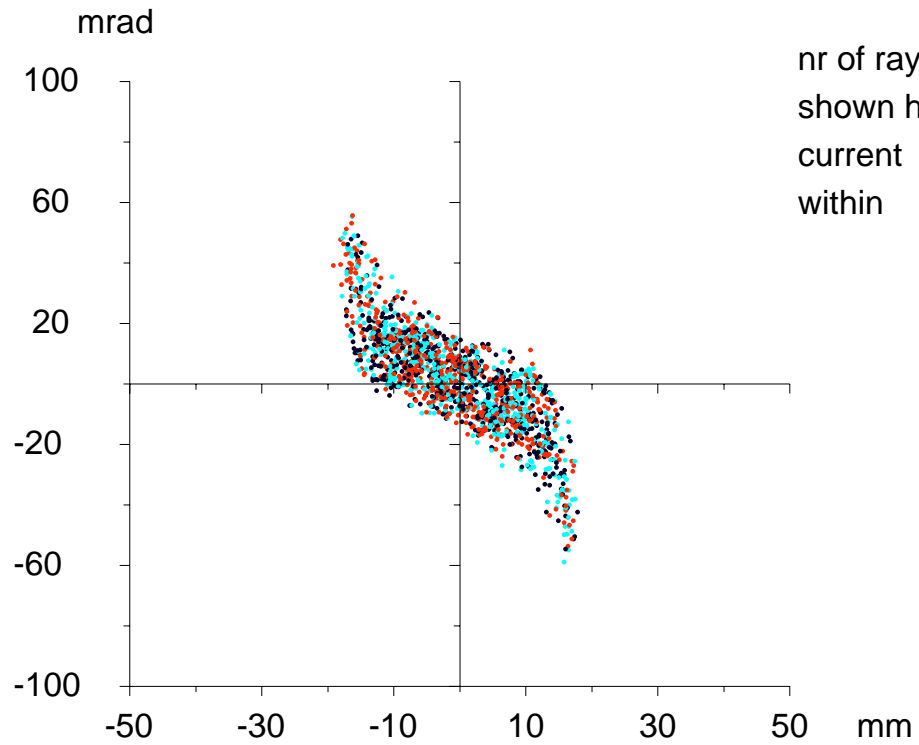

relax and drift

KOBRA3-INP

y emittance at 0.660 m

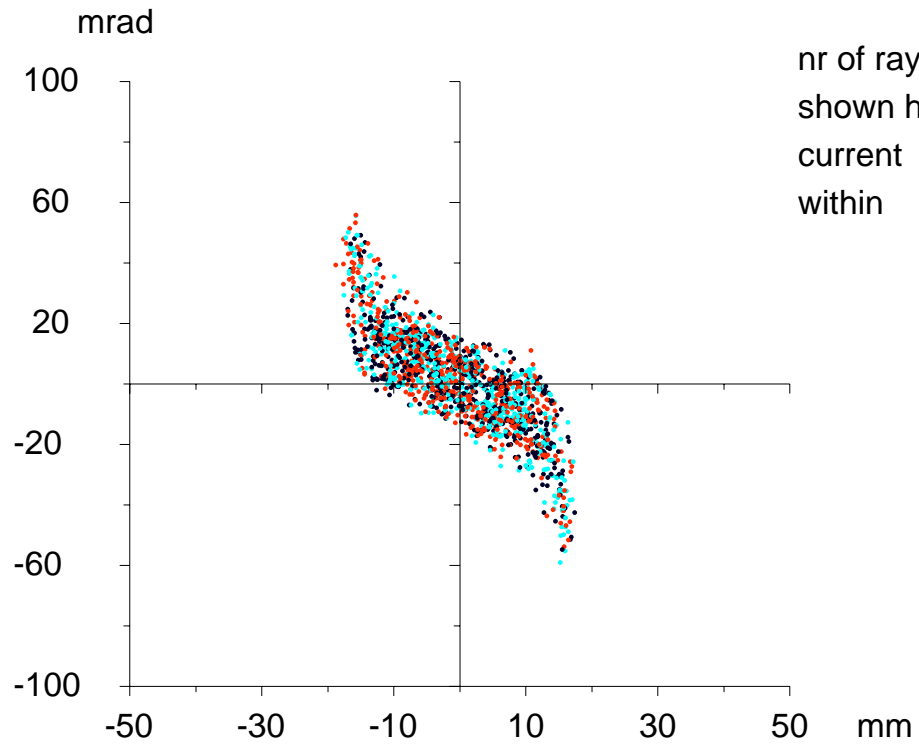

relax and drift

KOBRA3-INP

y emittance at 0.710 m

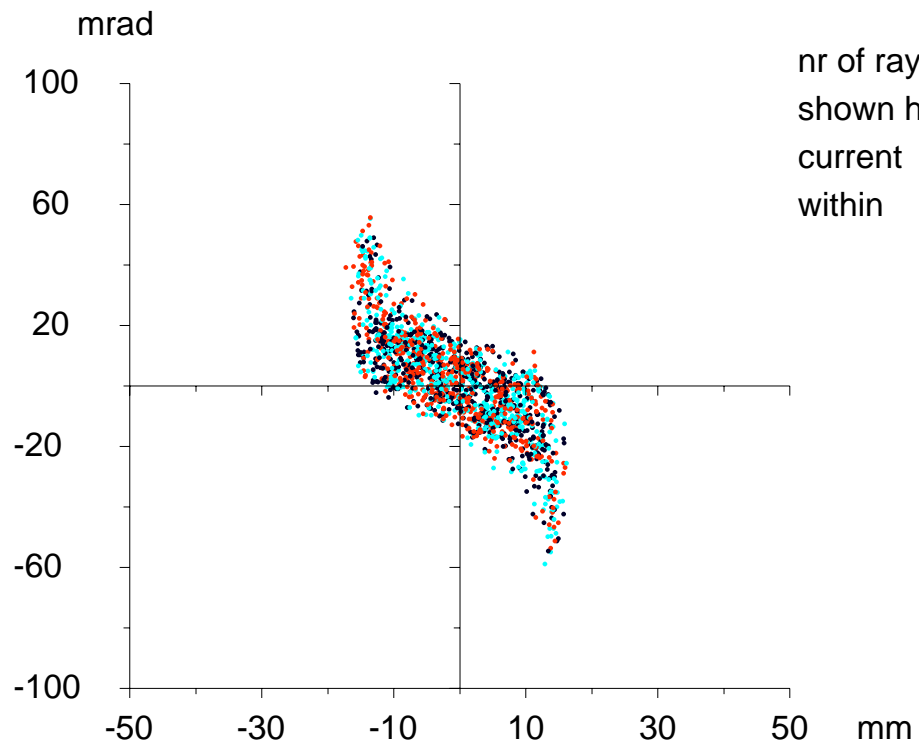

relax and drift

KOBRA3-INP

y emittance at 0.760 m

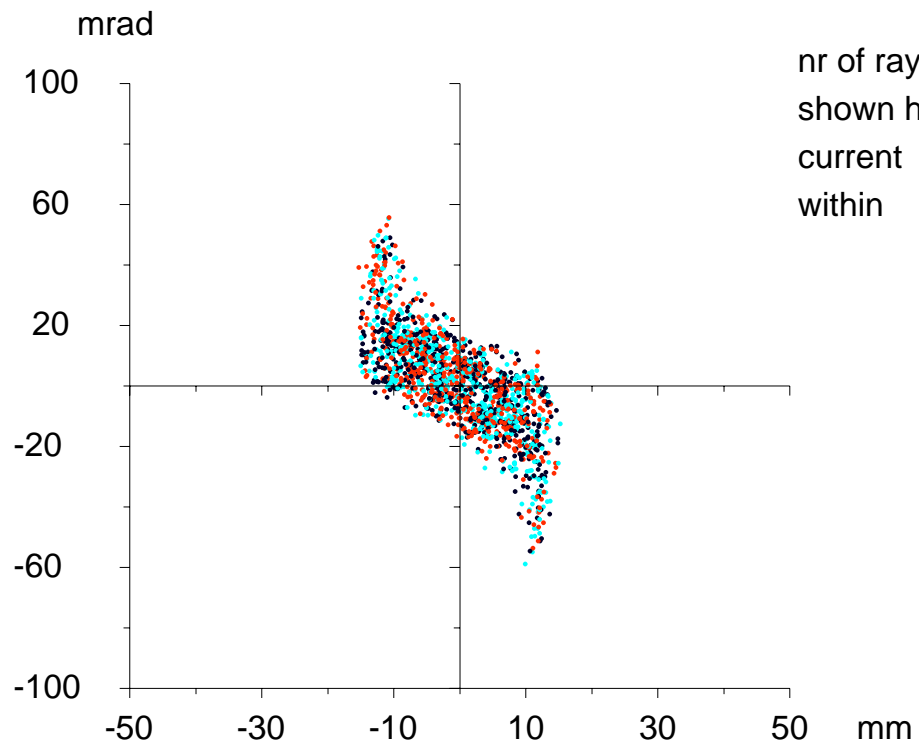

relax and drift

KOBRA3-INP

y emittance at 0.810 m

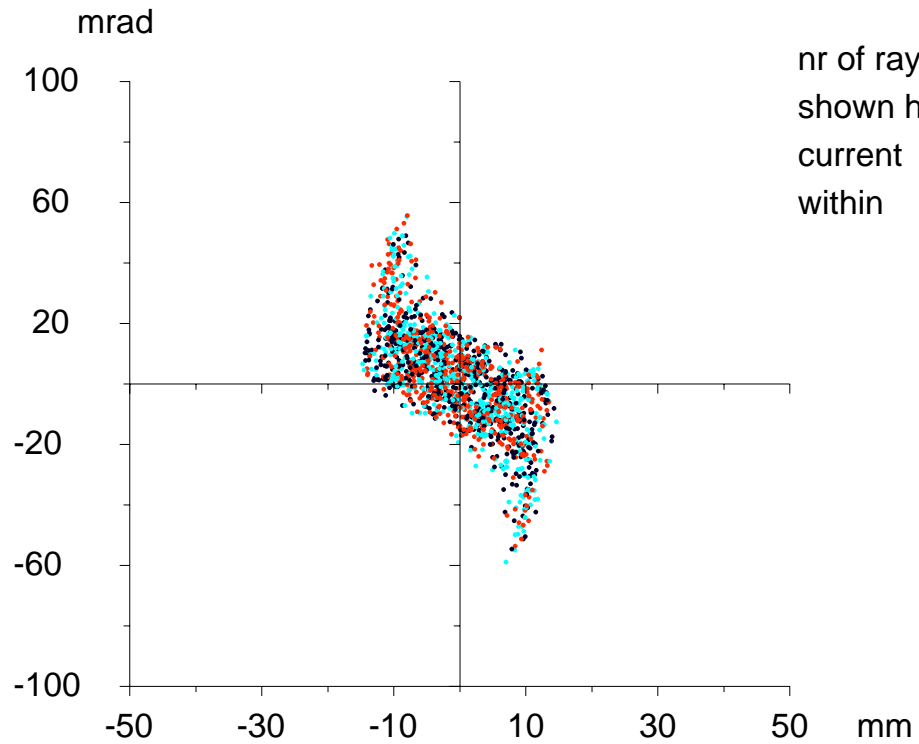

relax and drift

KOBRA3-INP

y emittance at 0.860 m

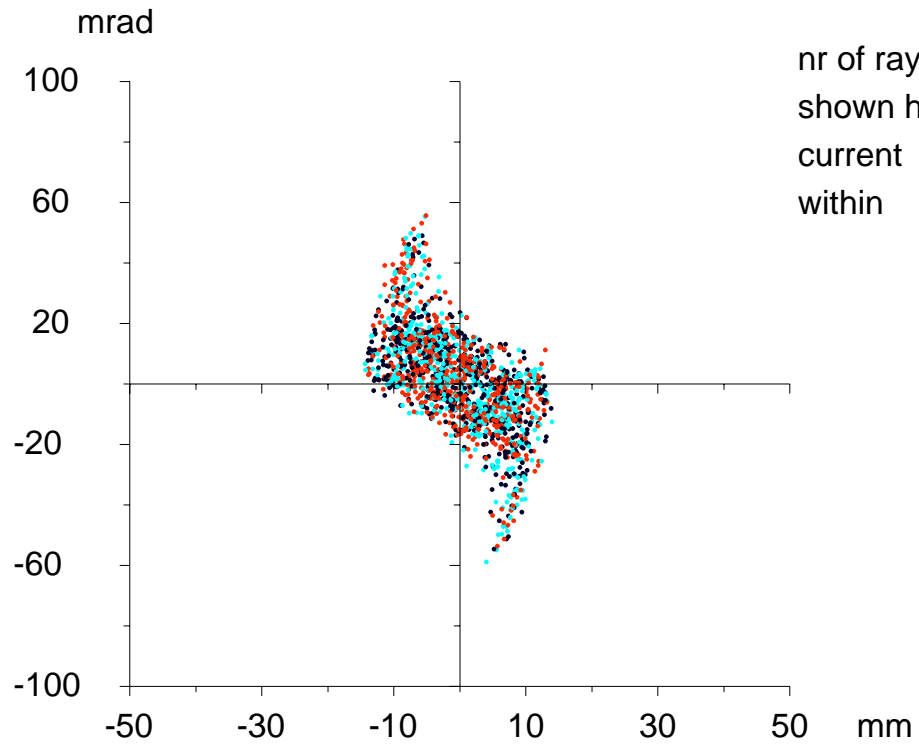

relax and drift

KOBRA3-INP

y emittance at 0.910 m

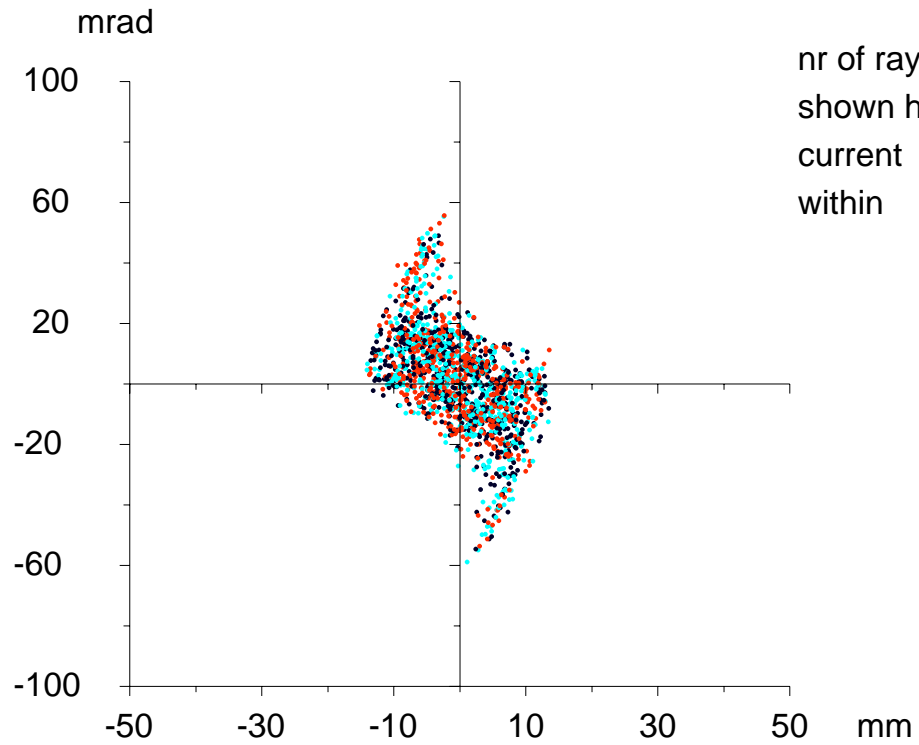

relax and drift

KOBRA3-INP

y emittance at 0.960 m

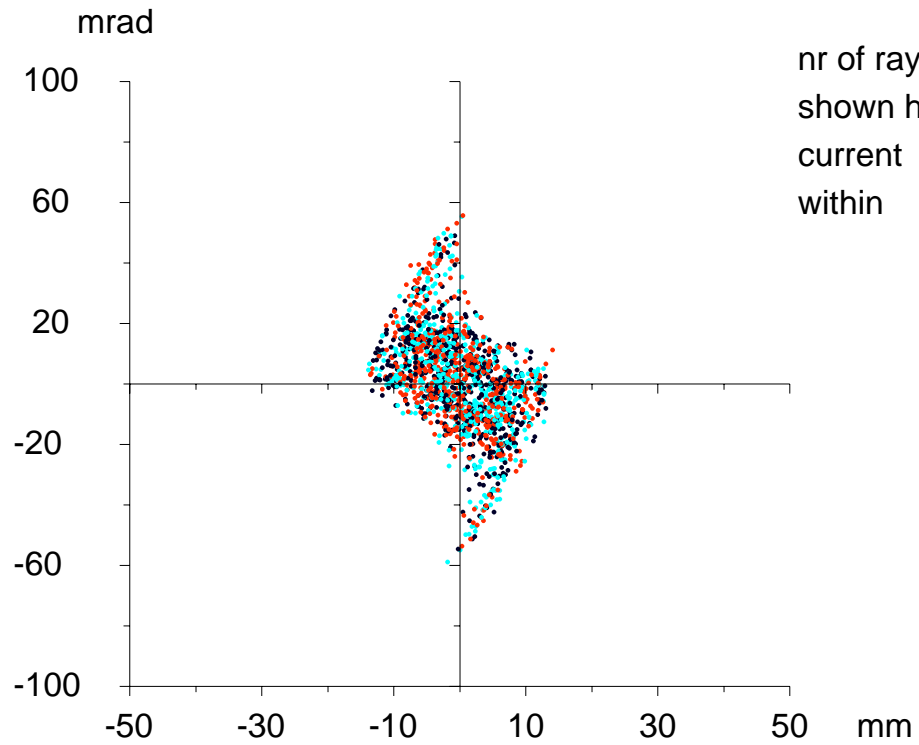

relax and drift

KOBRA3-INP

y emittance at 1.010 m

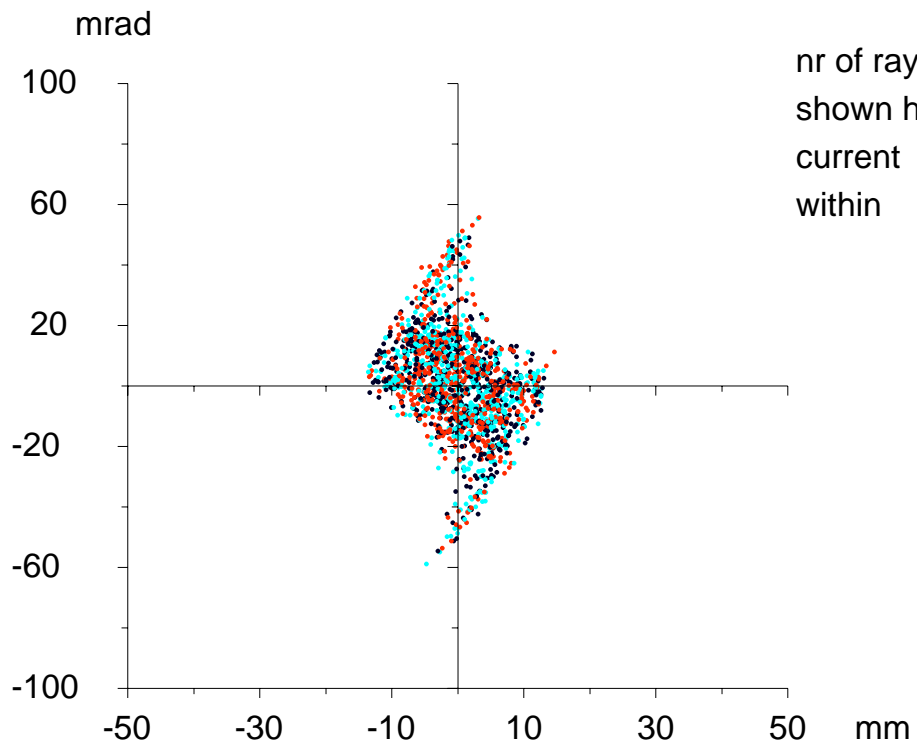

relax and drift

KOBRA3-INP

y emittance at 1.060 m

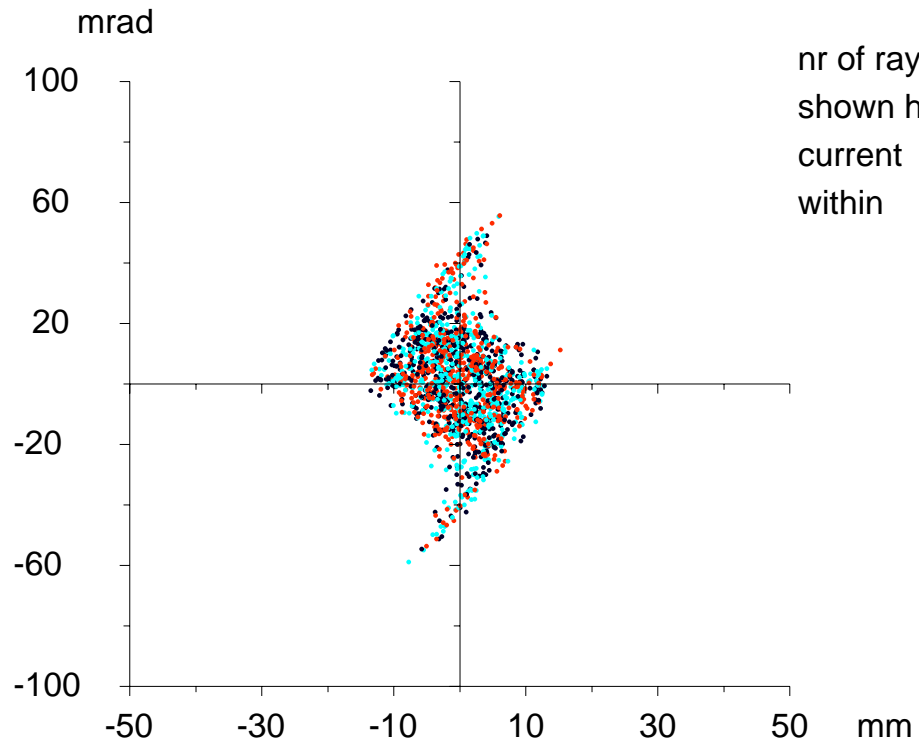

relax and drift

KOBRA3-INP

y emittance at 1.110 m

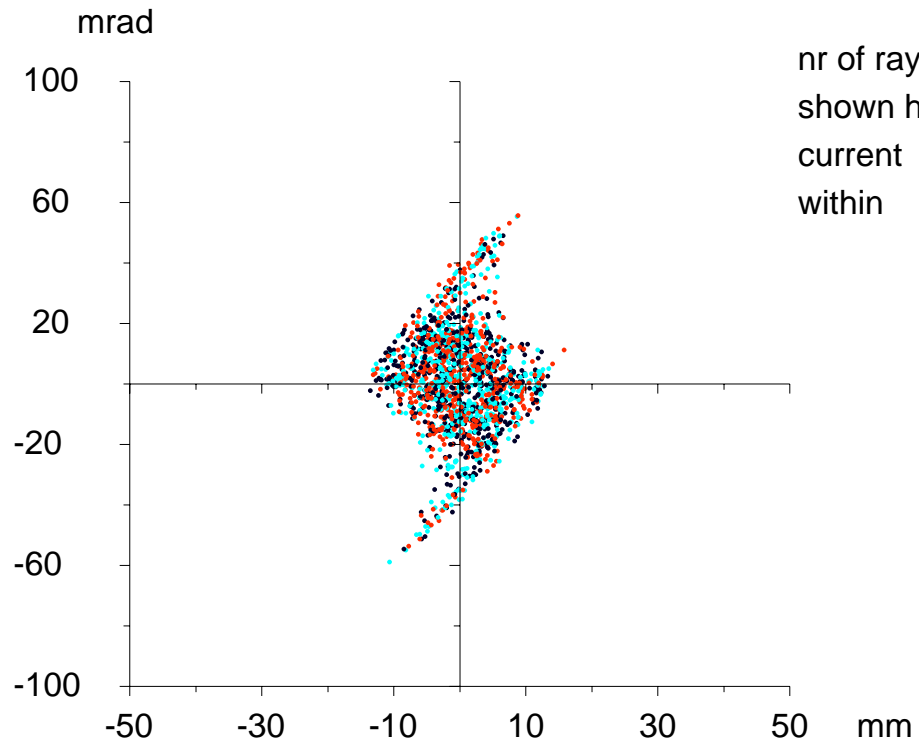

nr of rays	1664
shown here	1664
current	.0247 A
within	.0247 A

relax and drift

KOBRA3-INP

y emittance at 1.16 m

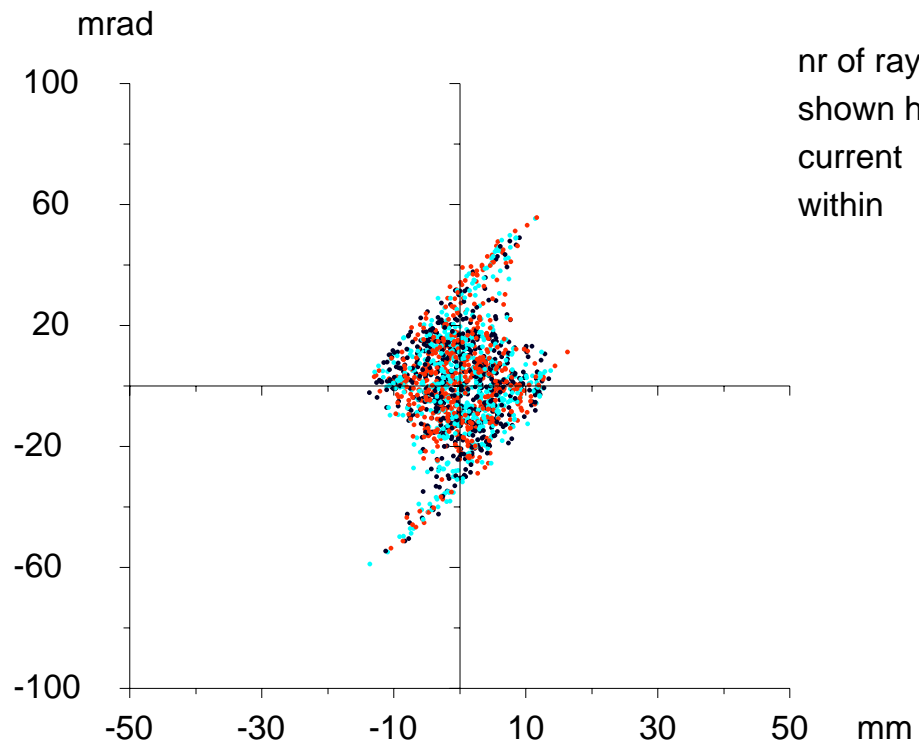

nr of rays	1664
shown here	1664
current	.0247 A
within	.0247 A

relax and drift

KOBRA3-INP

y emittance at 1.210 m

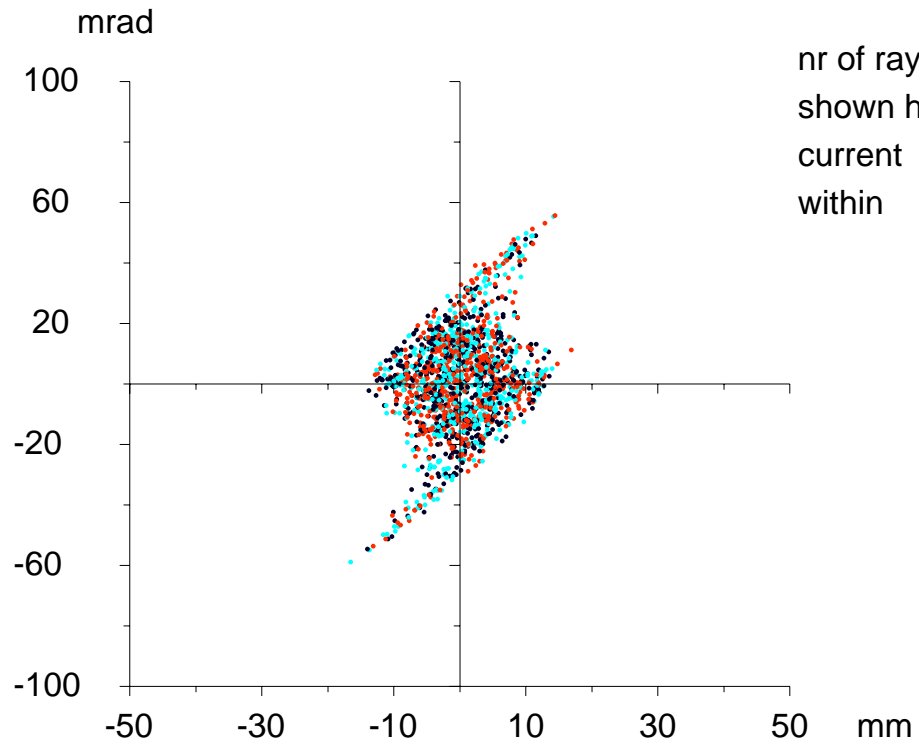

relax and drift

KOBRA3-INP

y emittance at 1.260 m

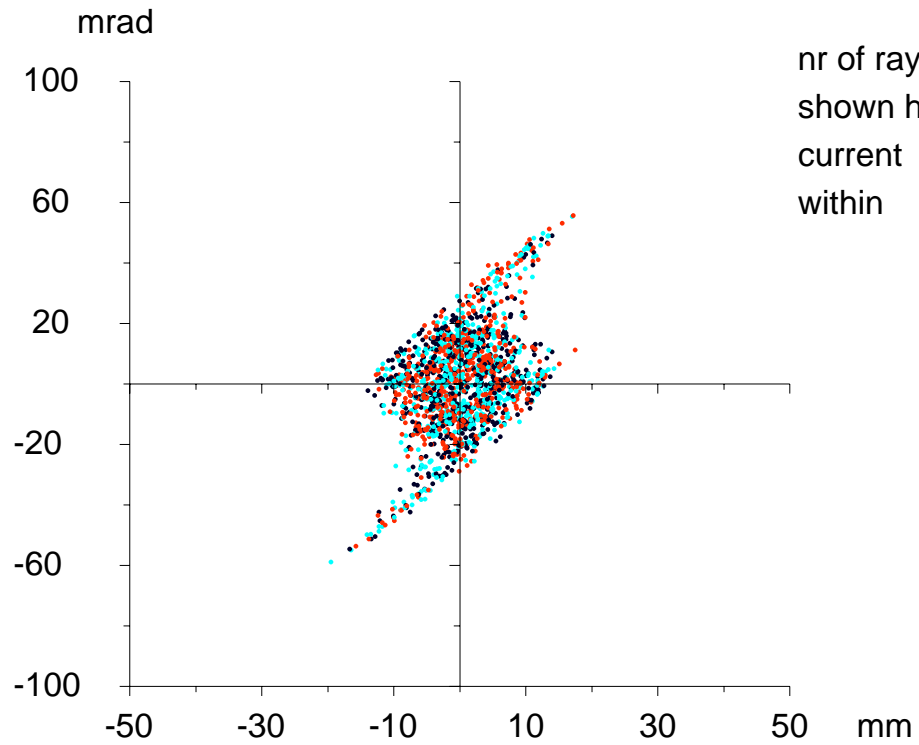

relax and drift

KOBRA3-INP

y emittance at 1.310 m

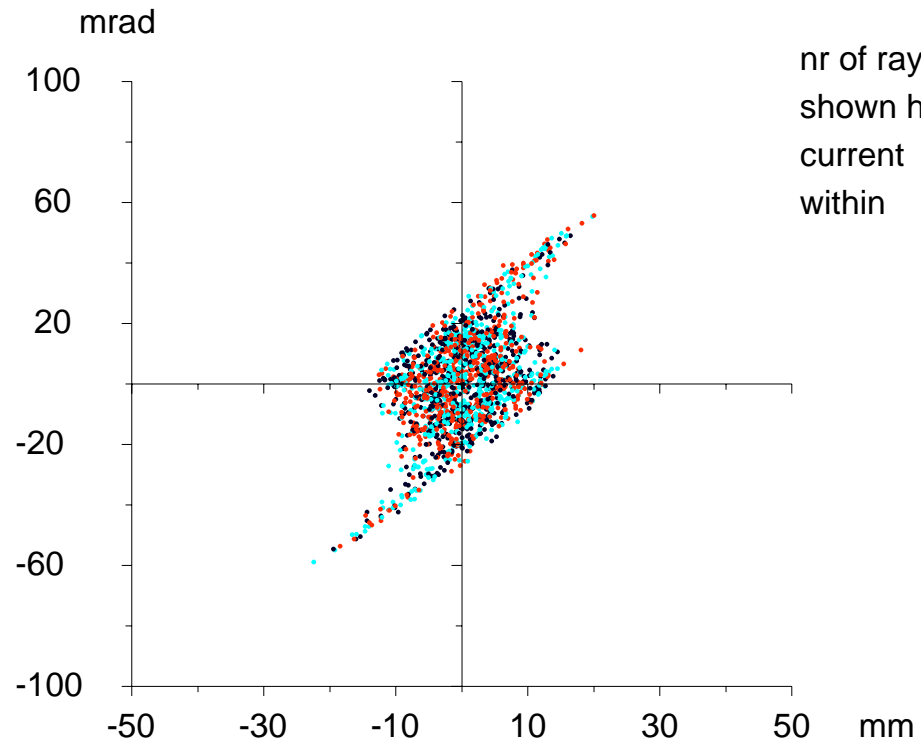

relax and drift

KOBRA3-INP

y emittance at 1.360 m

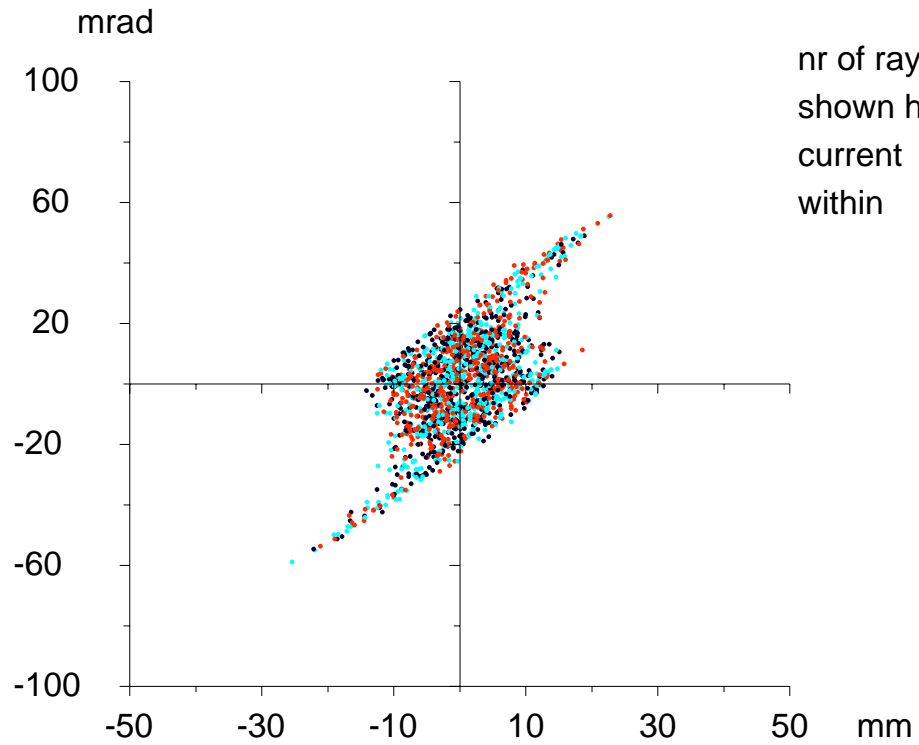

relax and drift

KOBRA3-INP

y emittance at 1.410 m

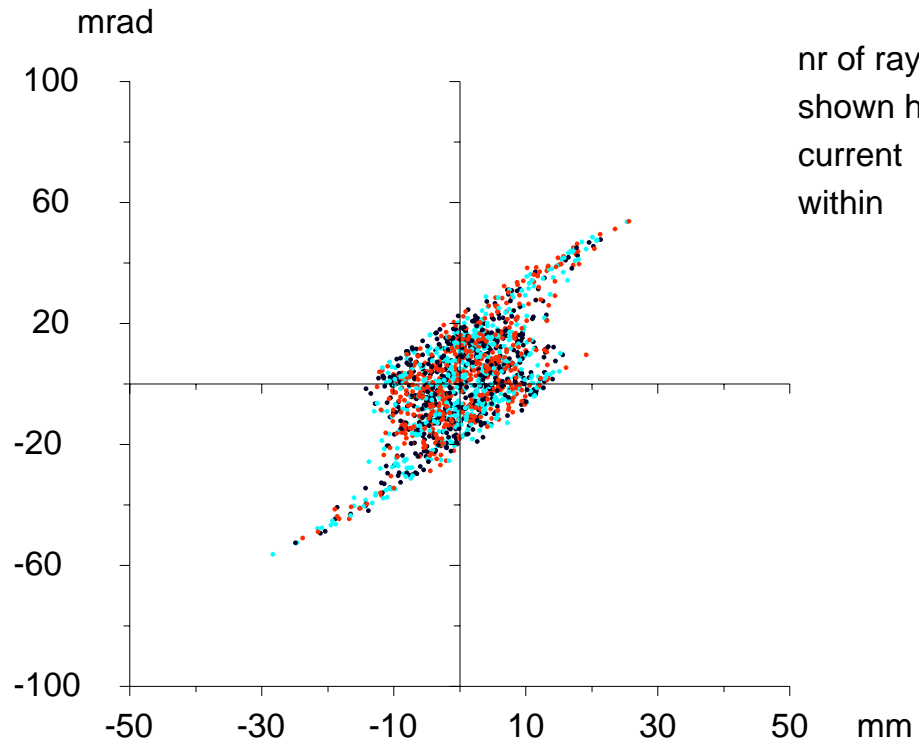

quadrupole ahead

KOBRA3-INP

y emittance at 1.420 m

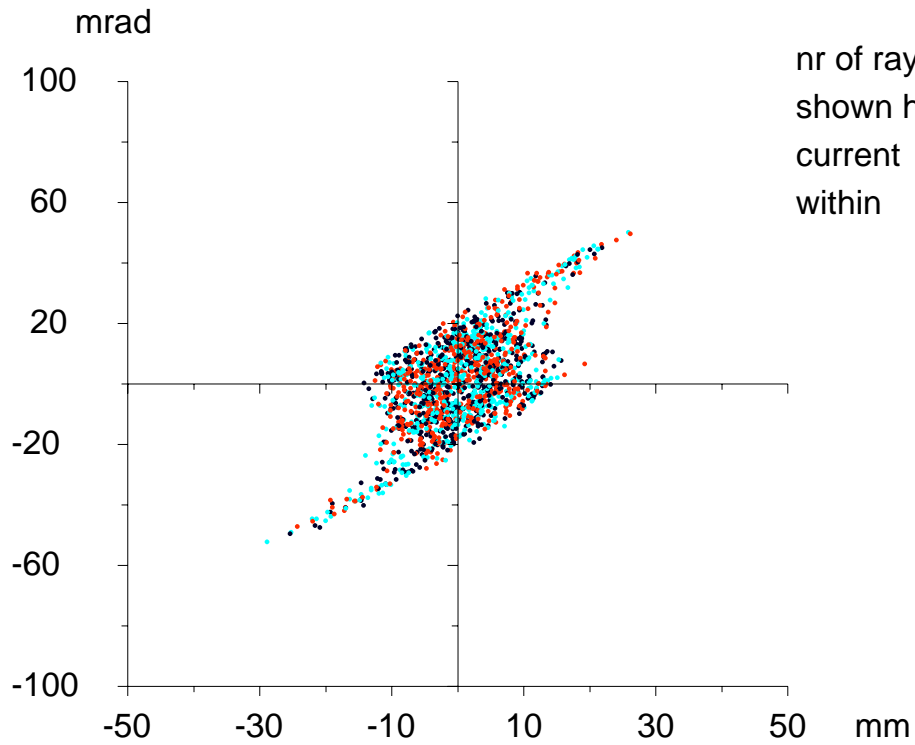

quadrupole ahead

KOBRA3-INP

y emittance at 1.430 m

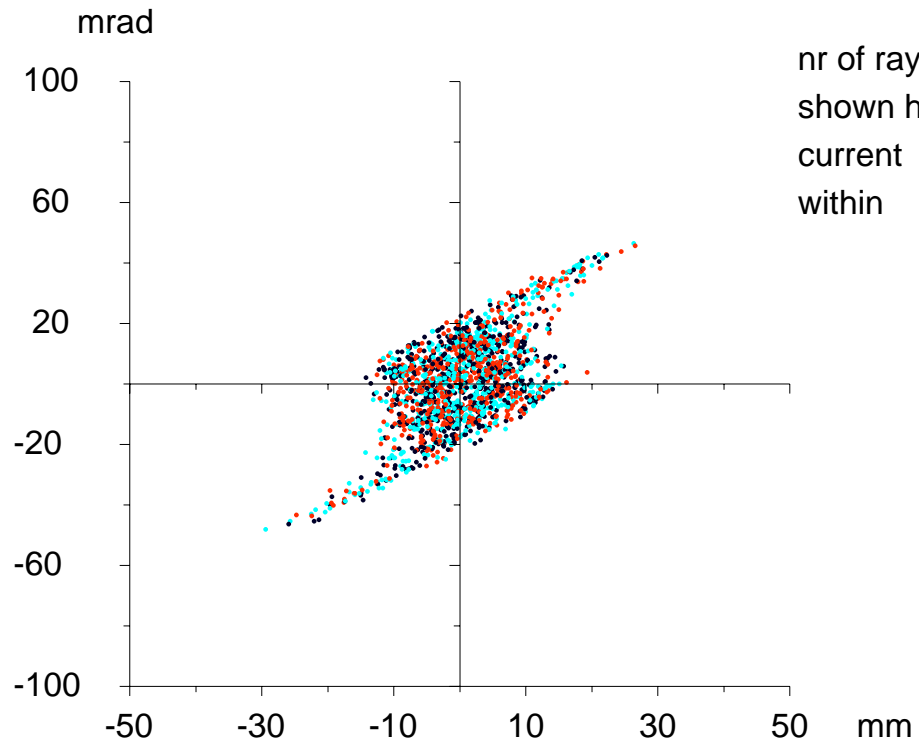

quadrupole ahead

KOBRA3-INP

y emittance at 1.440 m

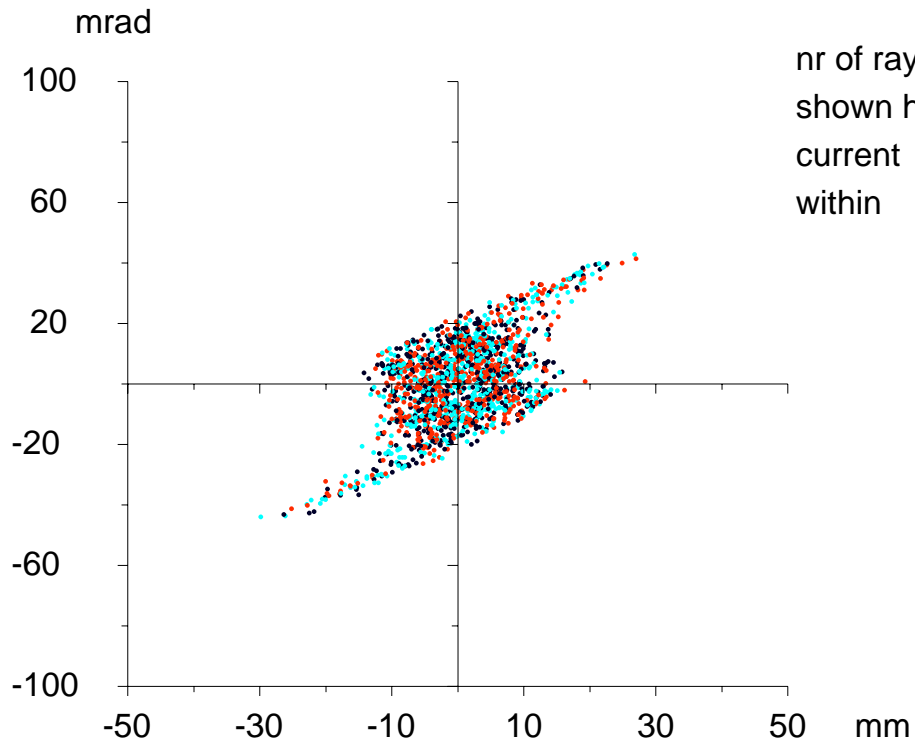

quadrupole ahead

KOBRA3-INP

y emittance at 1.450 m

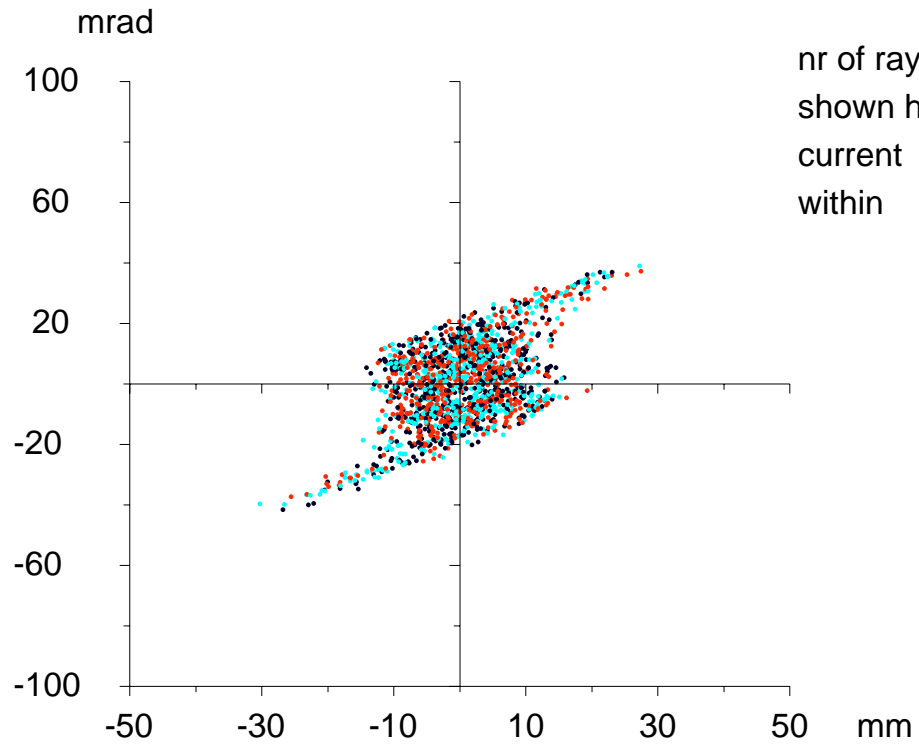

nr of rays	1664
shown here	1664
current	.0247 A
within	.0247 A

quadrupole ahead

KOBRA3-INP

y emittance at 1.460 m

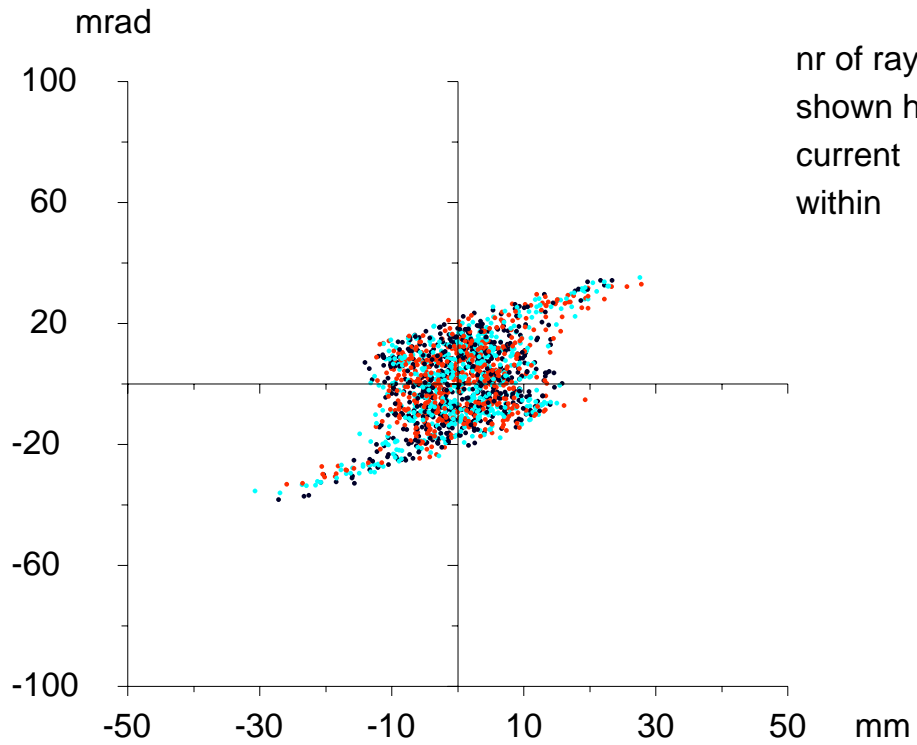

quadrupole ahead

KOBRA3-INP

y emittance at 1.470 m

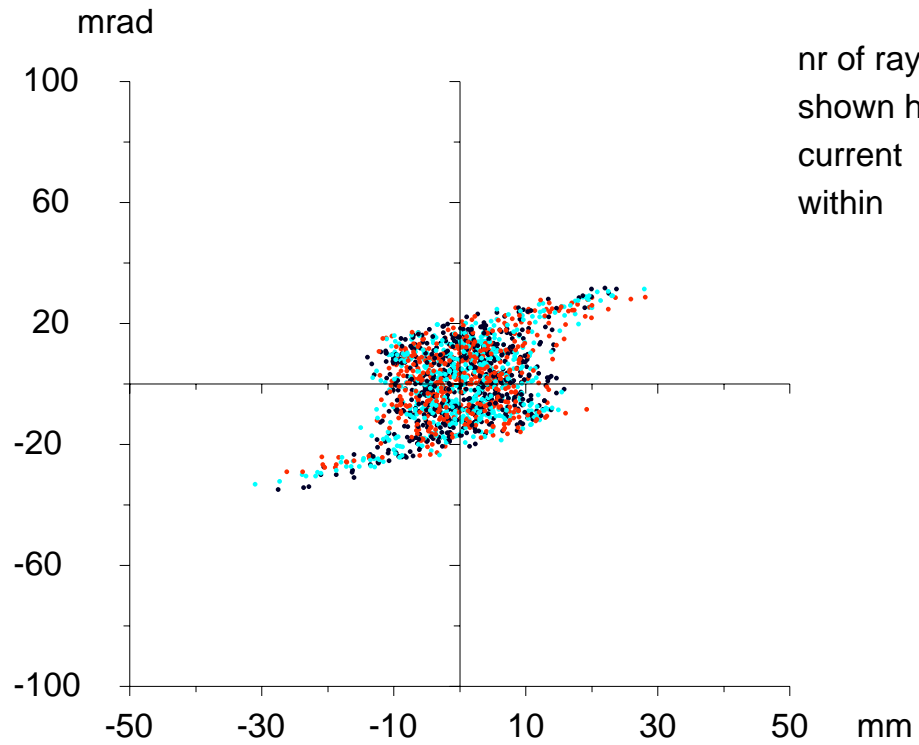

quadrupole ahead

KOBRA3-INP

y emittance at 1.480 m

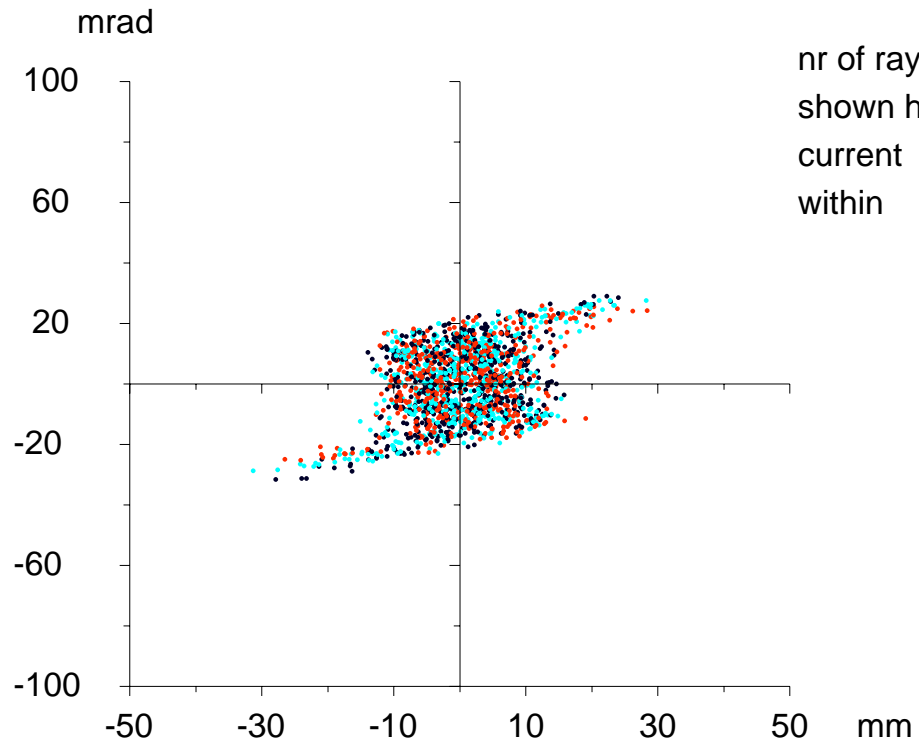

nr of rays	1664
shown here	1664
current	.0247 A
within	.0247 A

quadrupole ahead

KOBRA3-INP

y emittance at 1.490 m

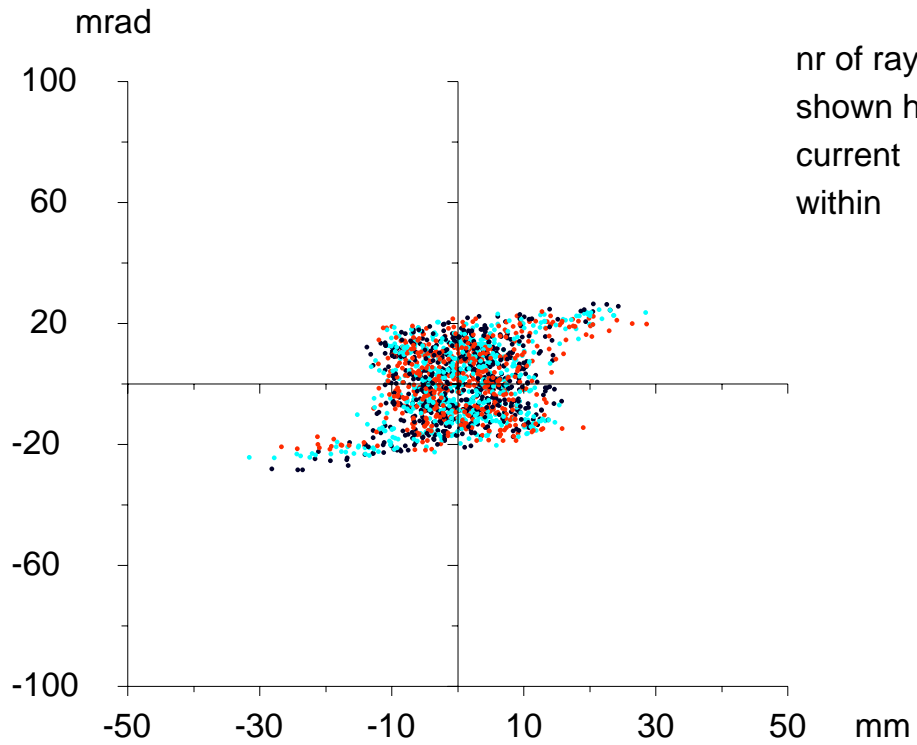

quadrupole ahead

KOBRA3-INP

y emittance at 1.500 m

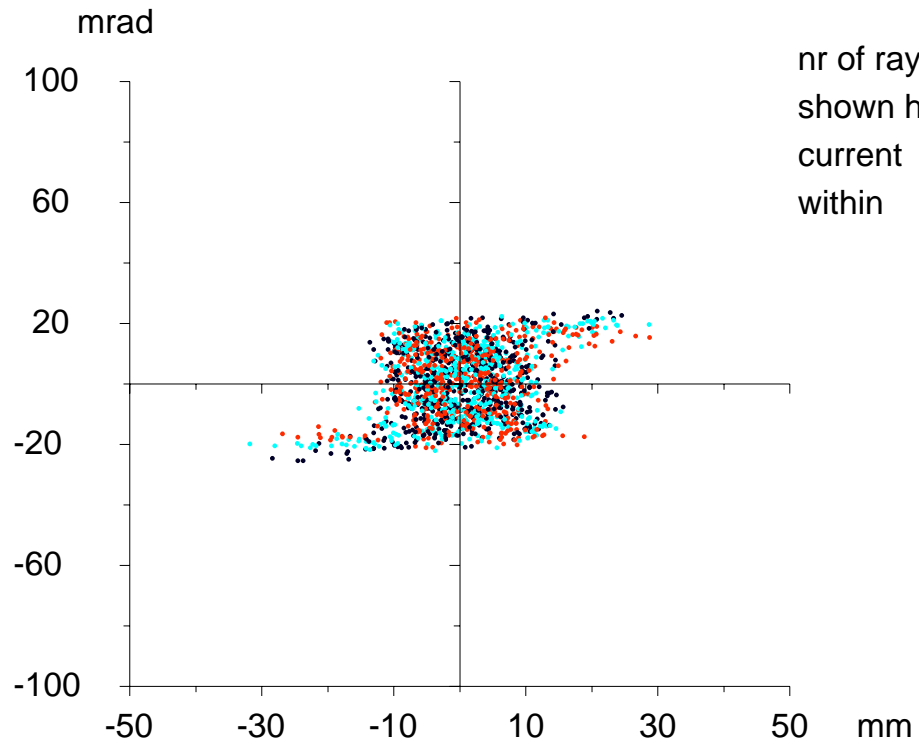

quadrupole ahead

KOBRA3-INP

y emittance at 1.510 m

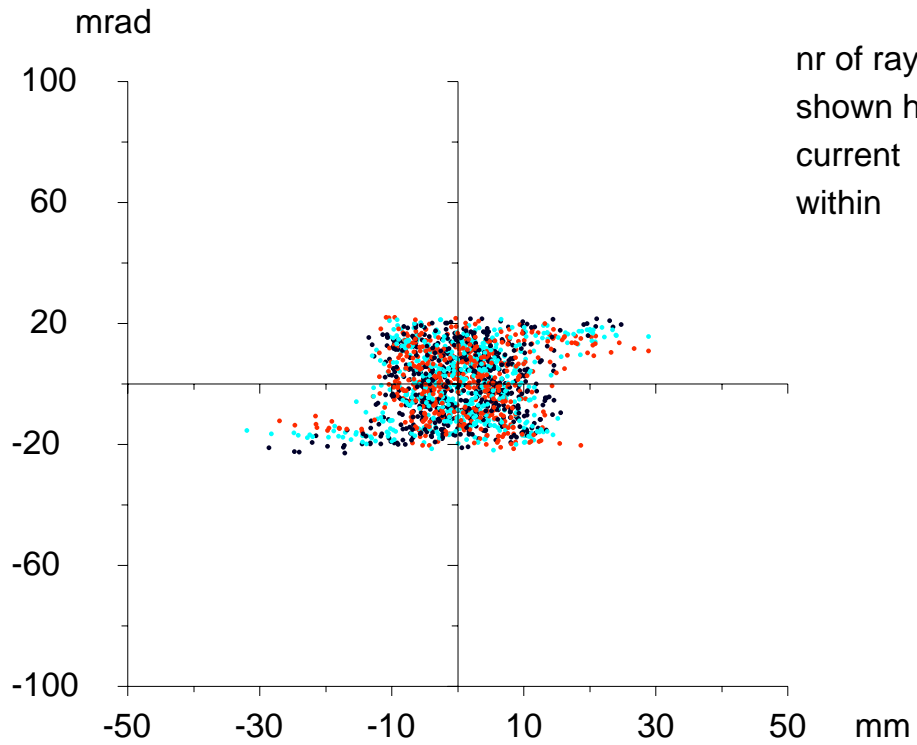

quadrupole ahead

KOBRA3-INP

y emittance at 1.520 m

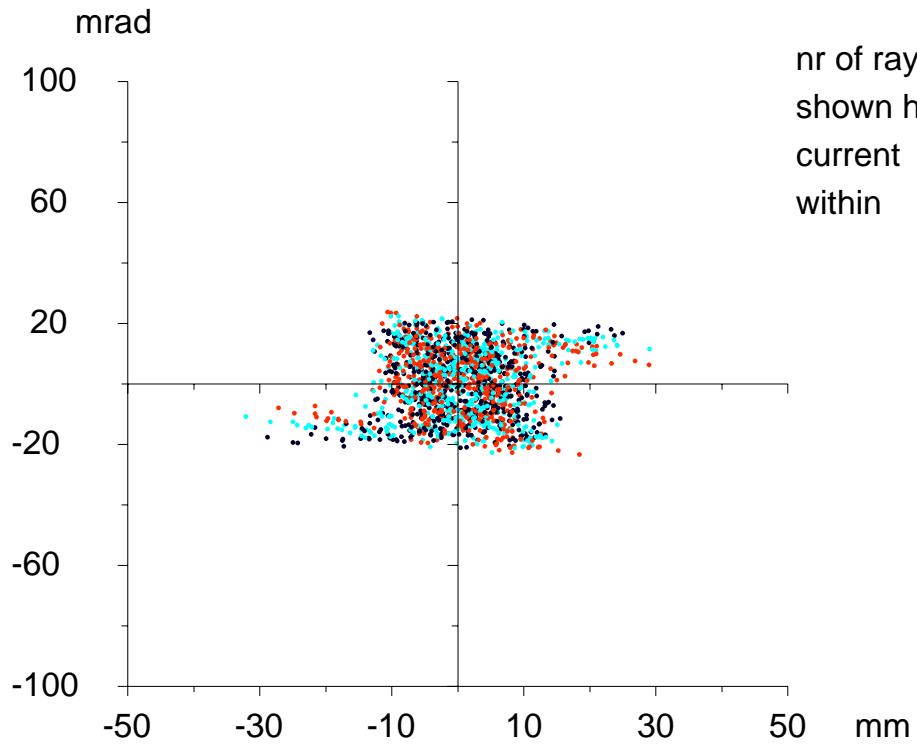

quadrupole ahead

KOBRA3-INP

y emittance at 1.530 m

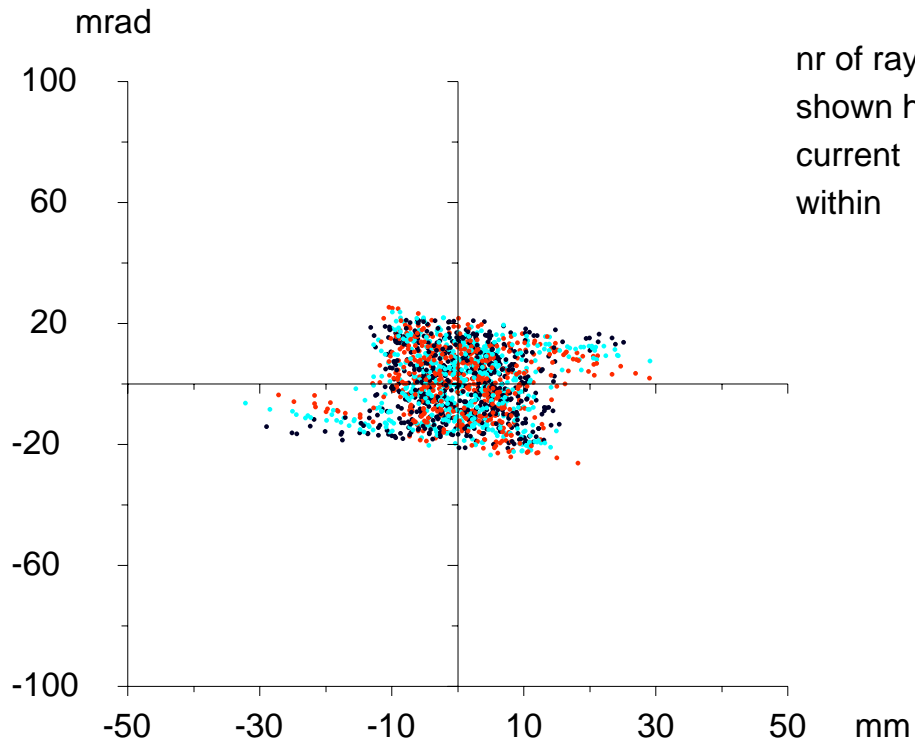

quadrupole ahead

KOBRA3-INP

y emittance at 1.540 m

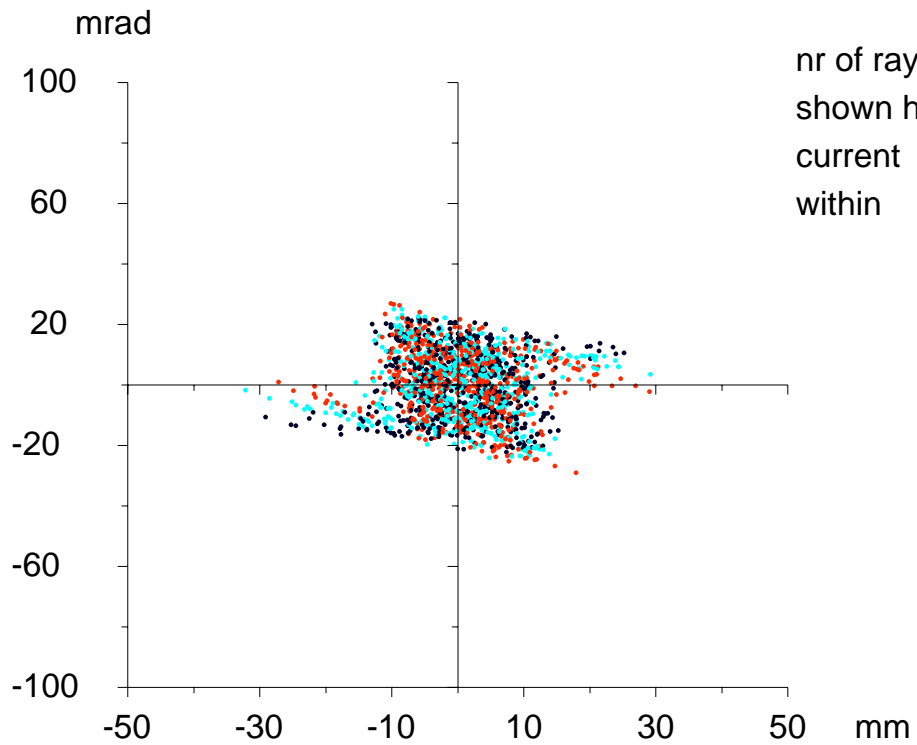

quadrupole ahead

KOBRA3-INP

y emittance at 1.550 m

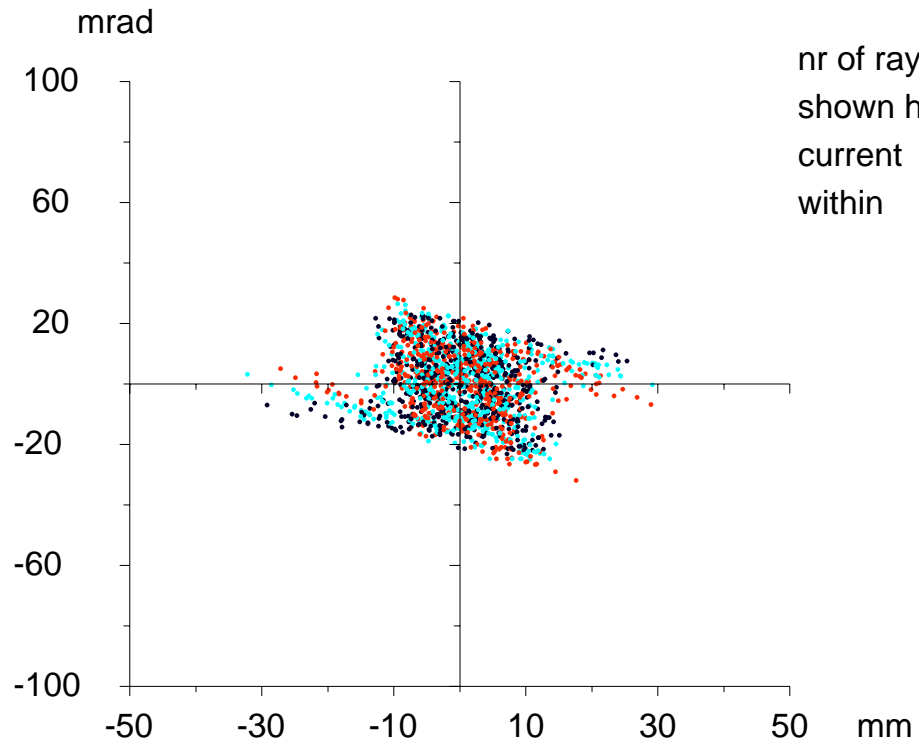

quadrupole ahead

KOBRA3-INP

y emittance at 1.560 m

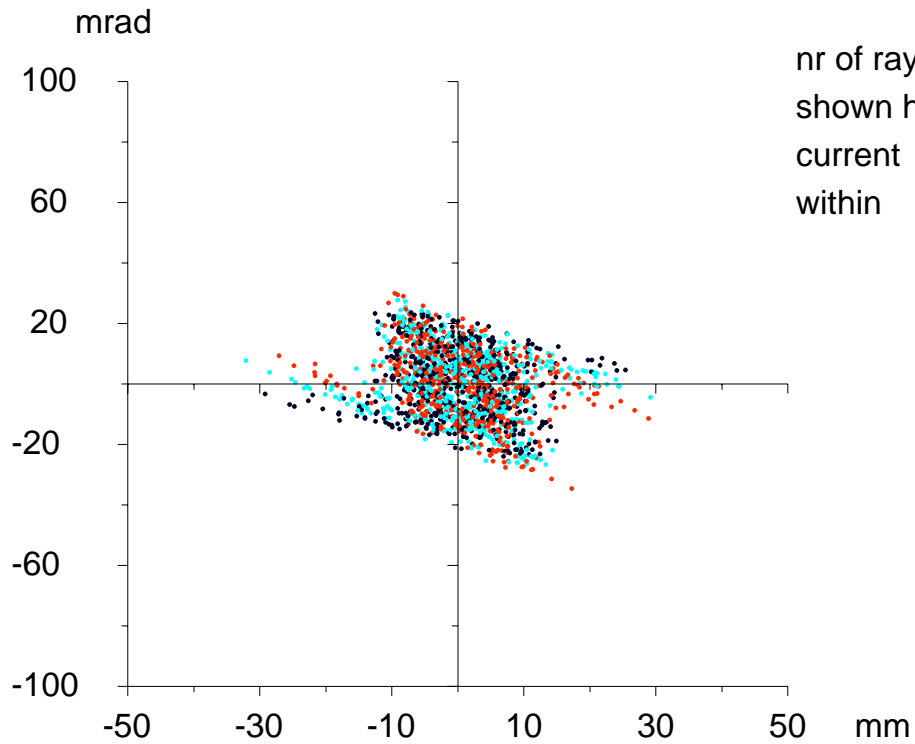

quadrupole ahead

KOBRA3-INP

y emittance at 1.570 m

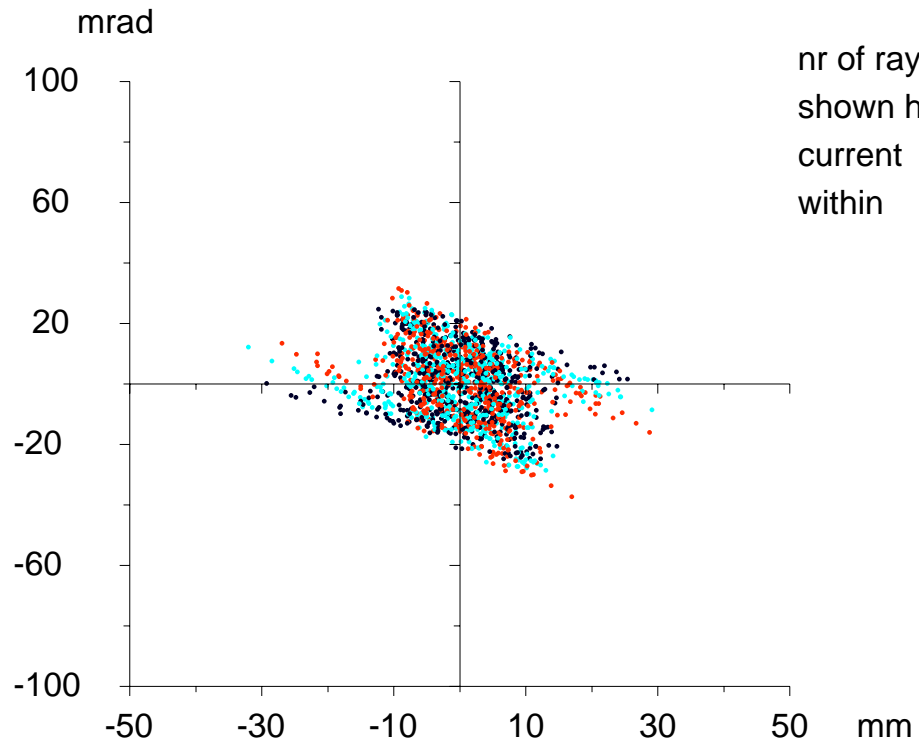

quadrupole ahead

KOBRA3-INP

y emittance at 1.580 m

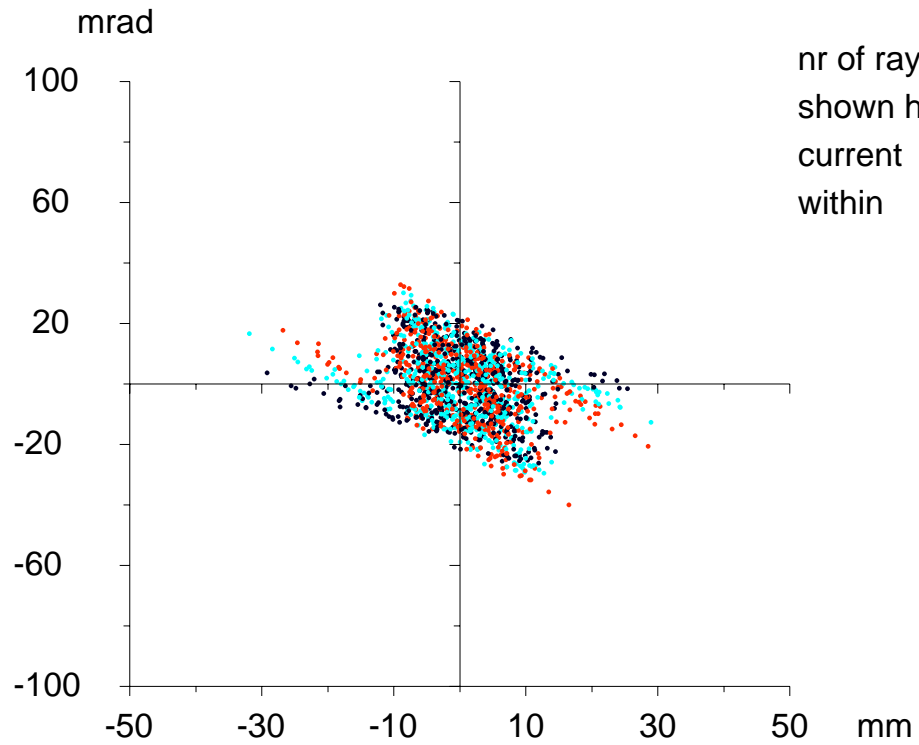

quadrupole ahead

KOBRA3-INP

y emittance at 1.590 m

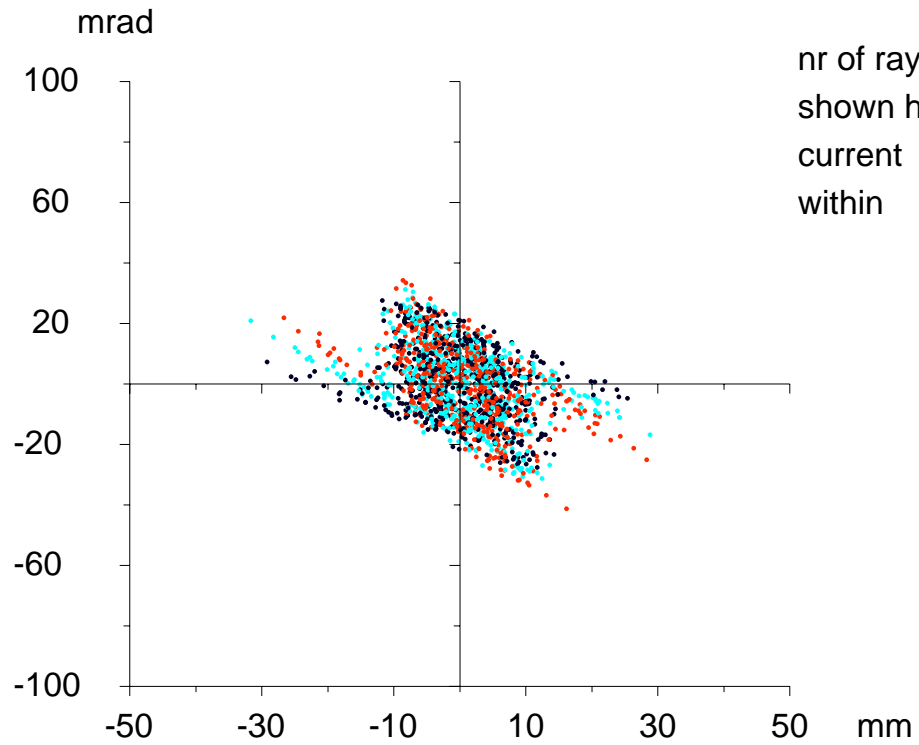

quadrupole ahead

KOBRA3-INP

y emittance at 1.600 m

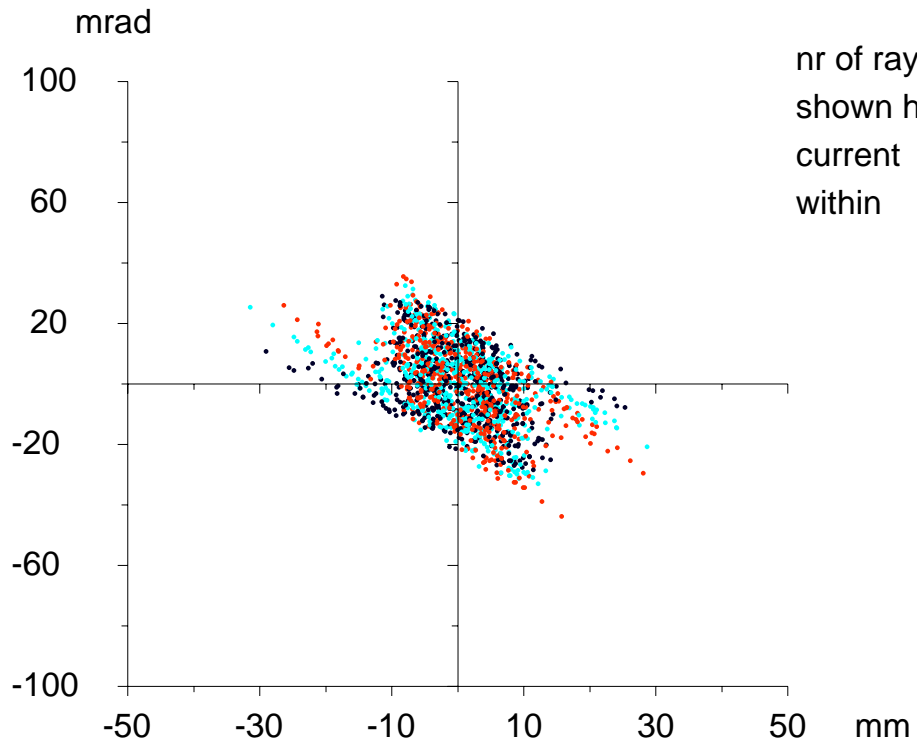

nr of rays	1664
shown here	1664
current	.0247 A
within	.0247 A

quadrupole ahead

KOBRA3-INP

y emittance at 1.610 m

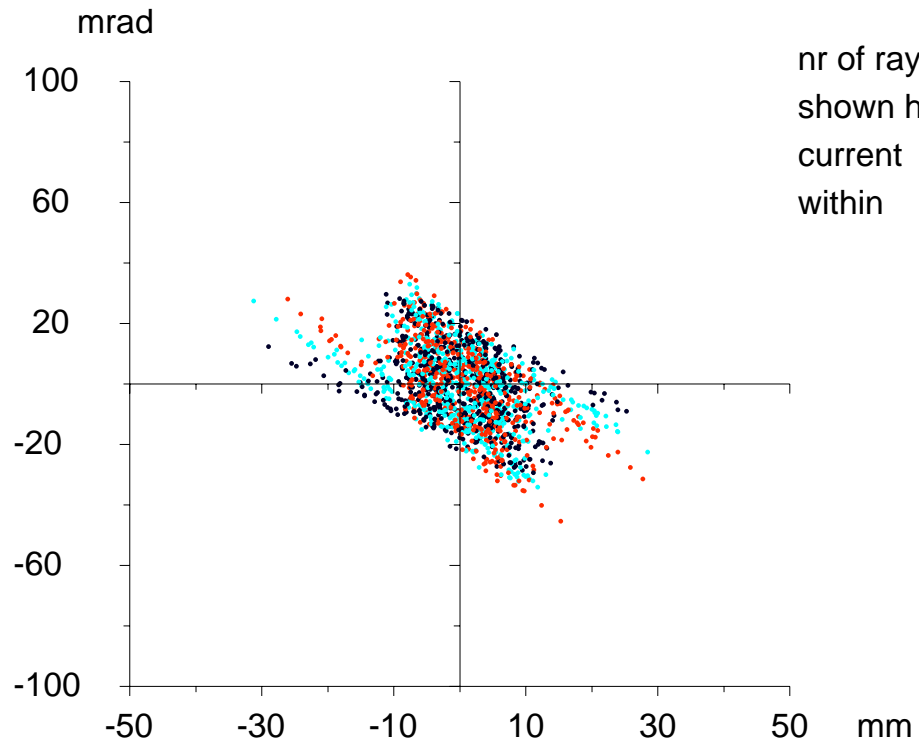

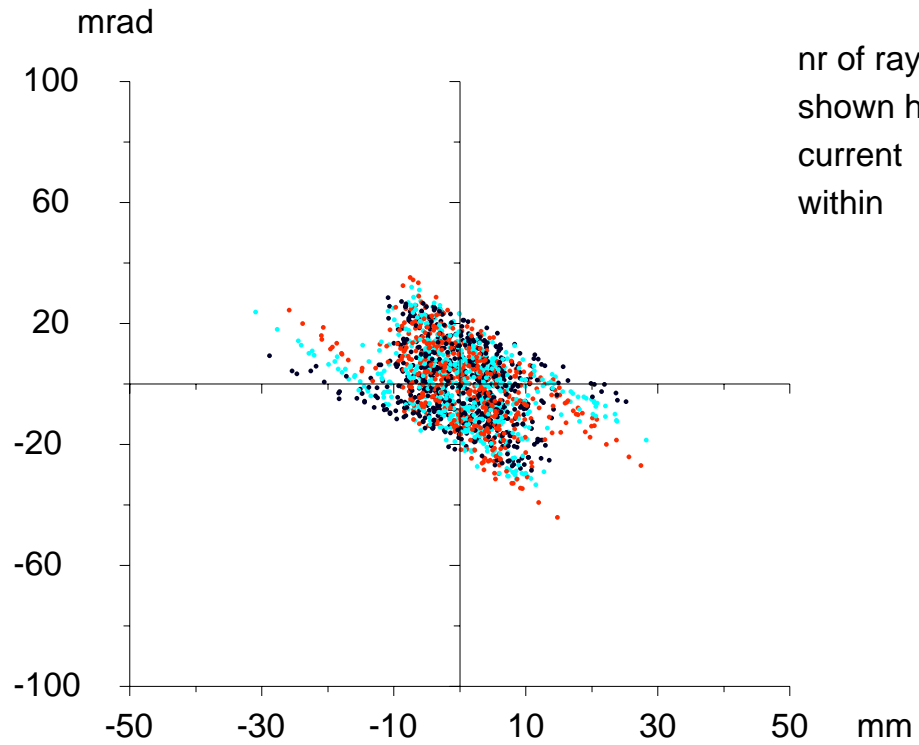
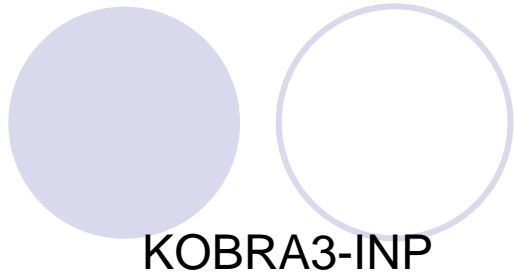

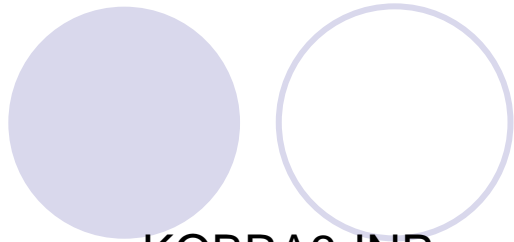

KOBRA3-INP

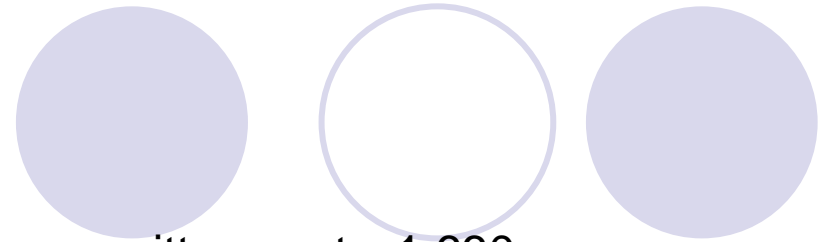

y emittance at 1.630 m

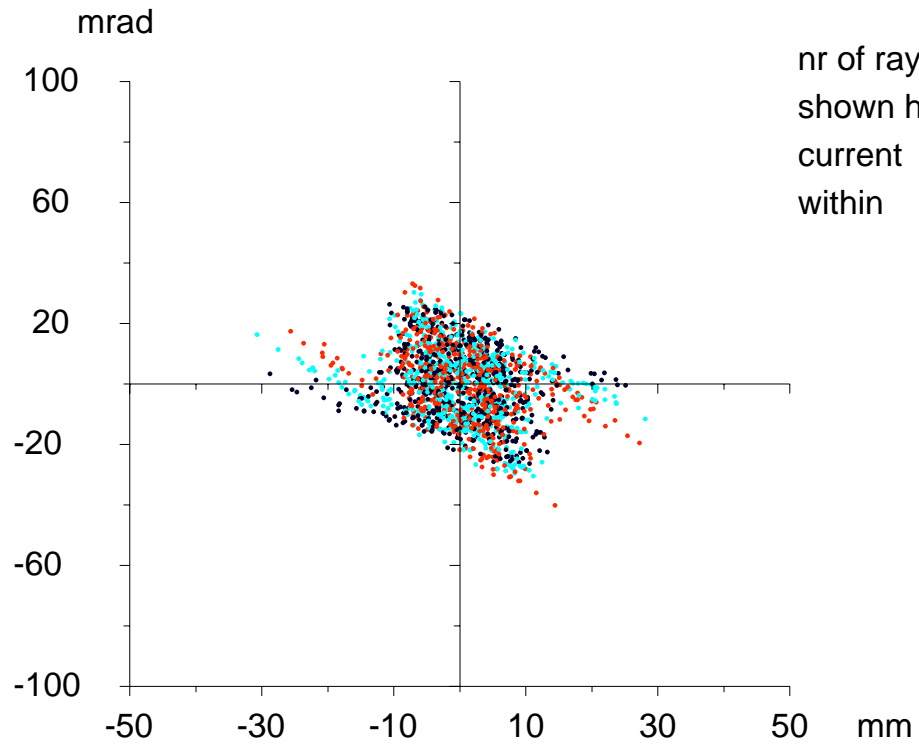

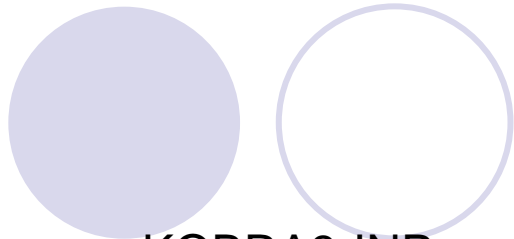

KOBRA3-INP

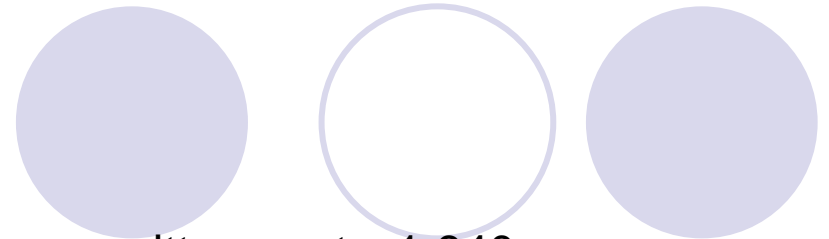

y emittance at 1.640 m

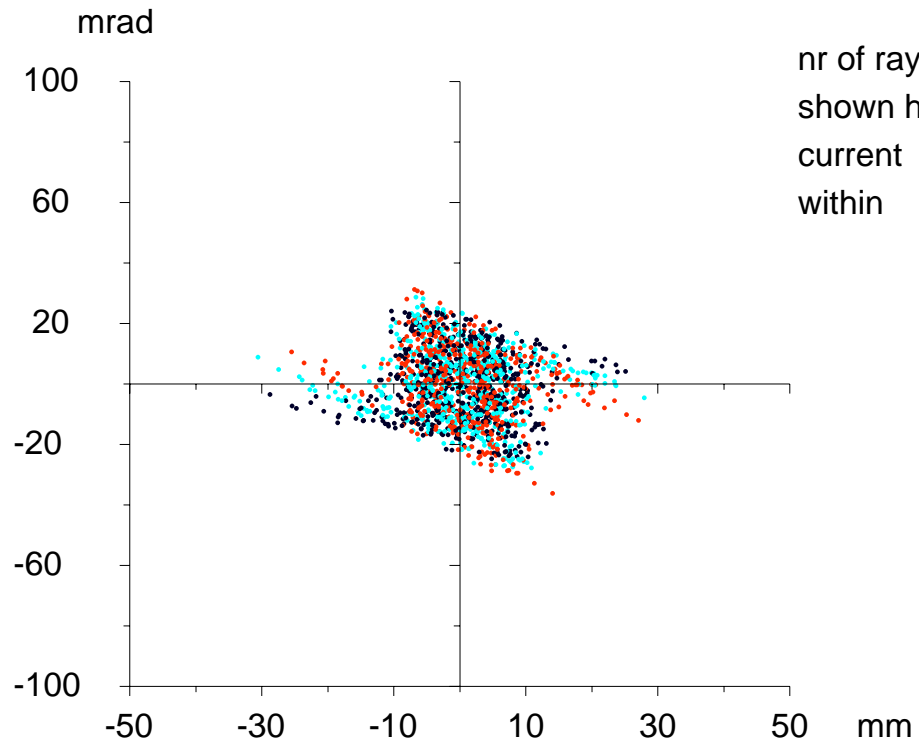

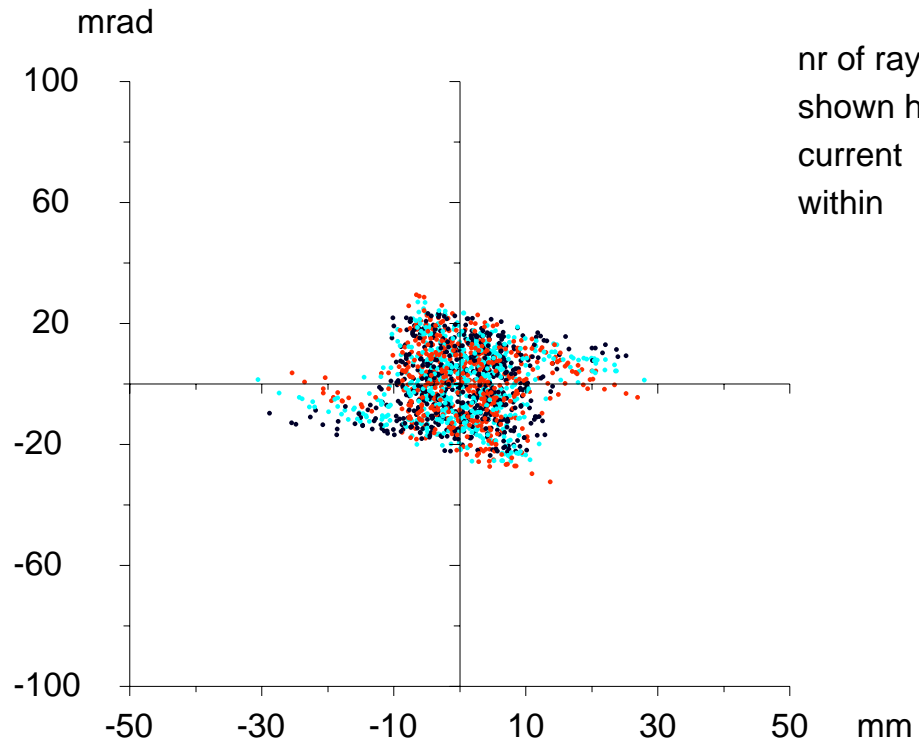
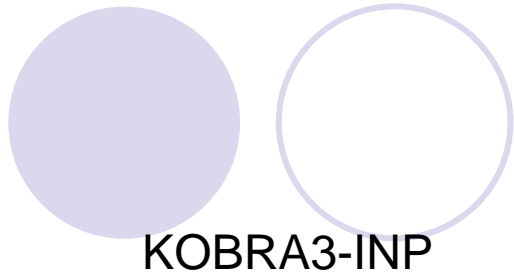

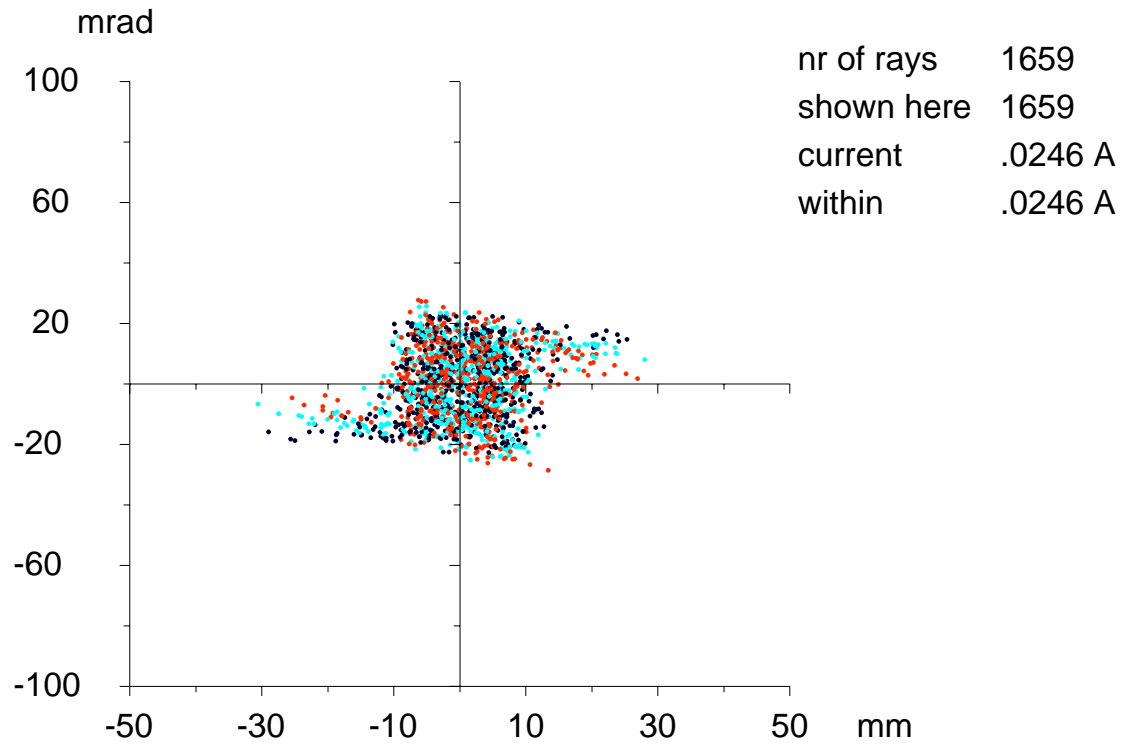
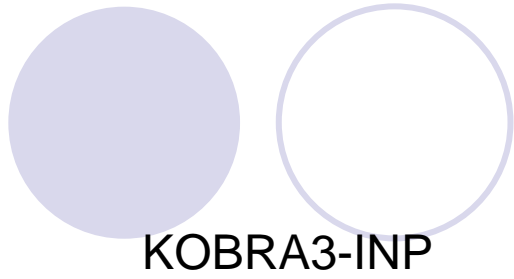

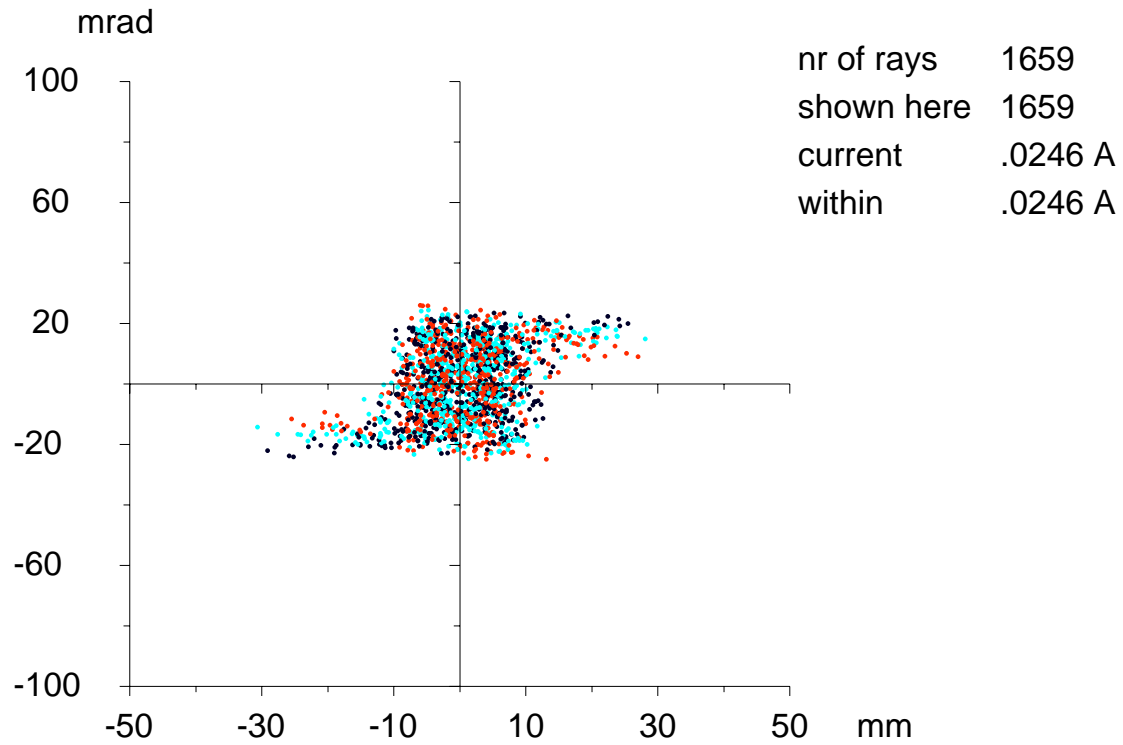
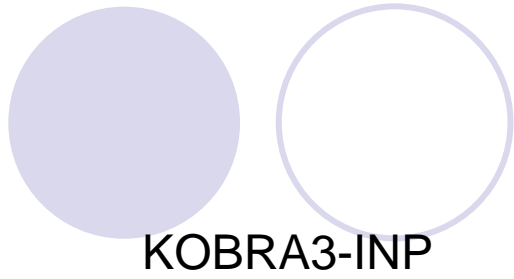

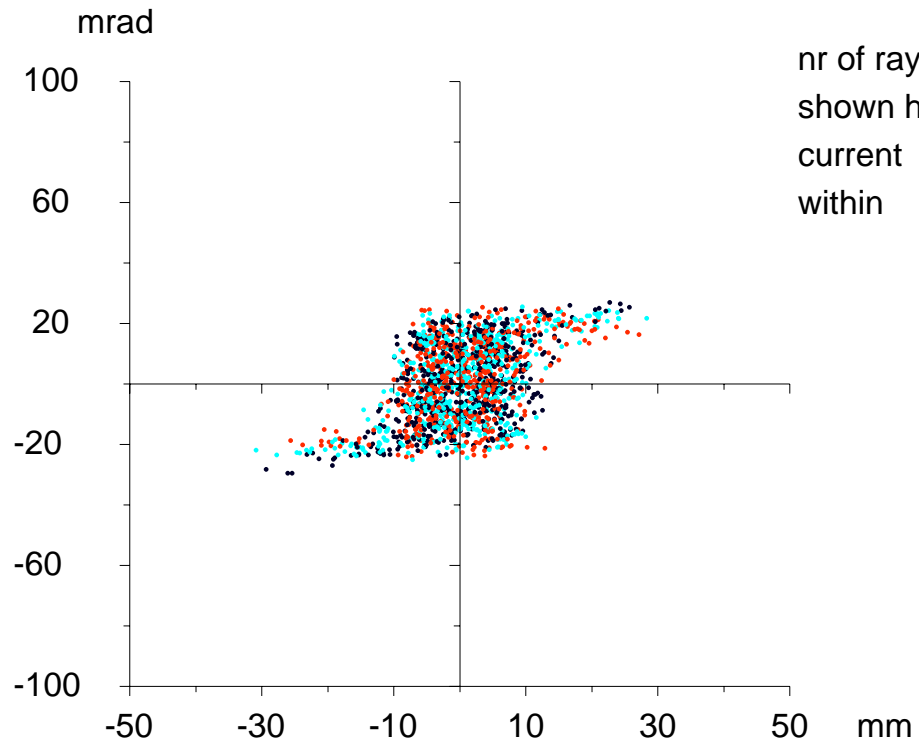
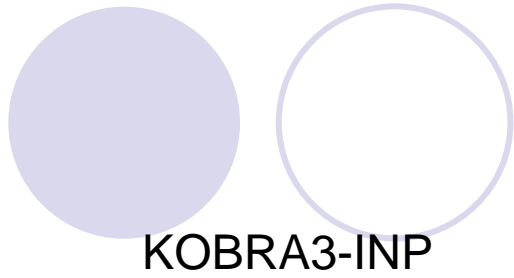

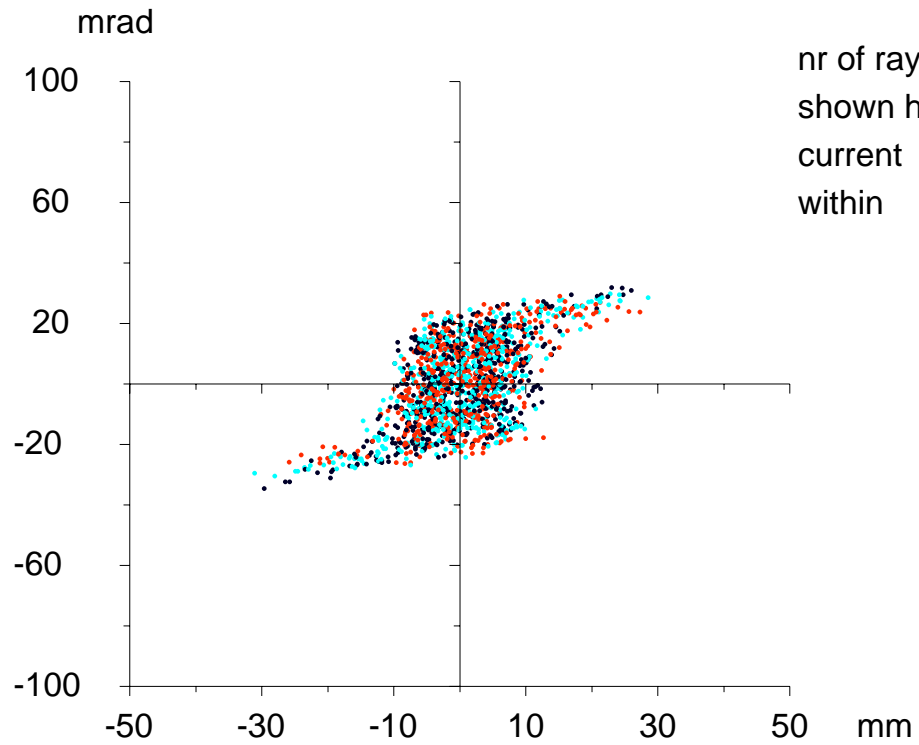
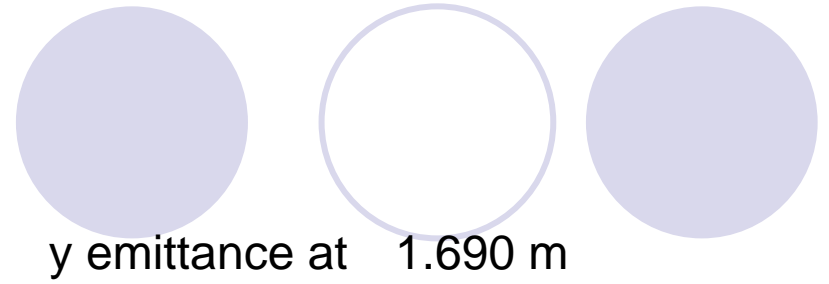
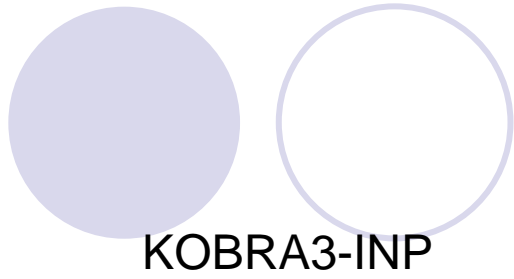

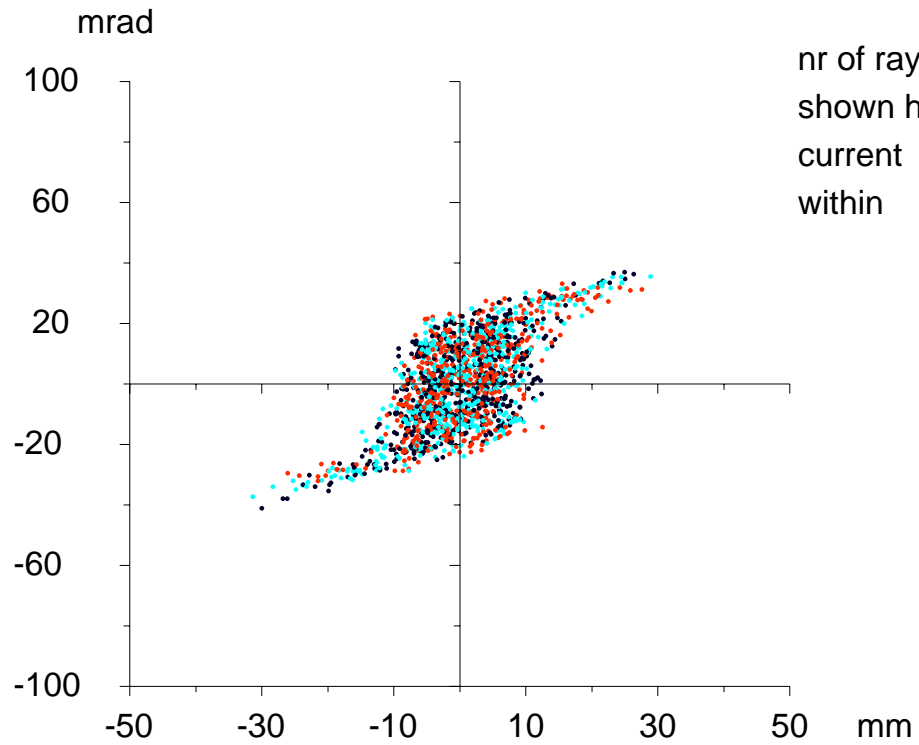
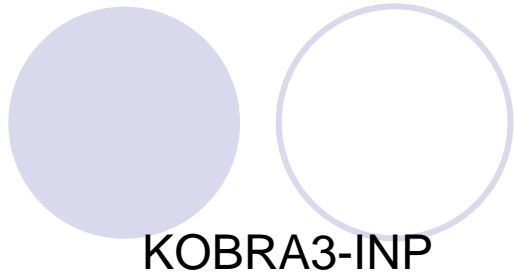



KOBRA3-INP

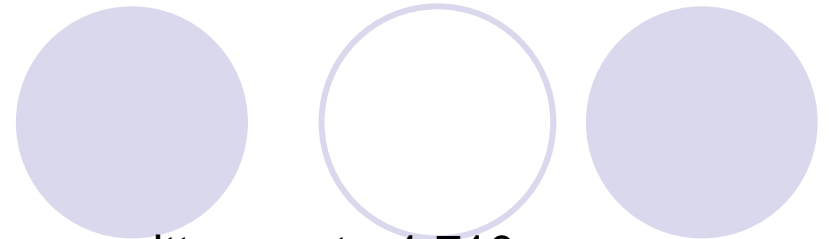

y emittance at 1.710 m

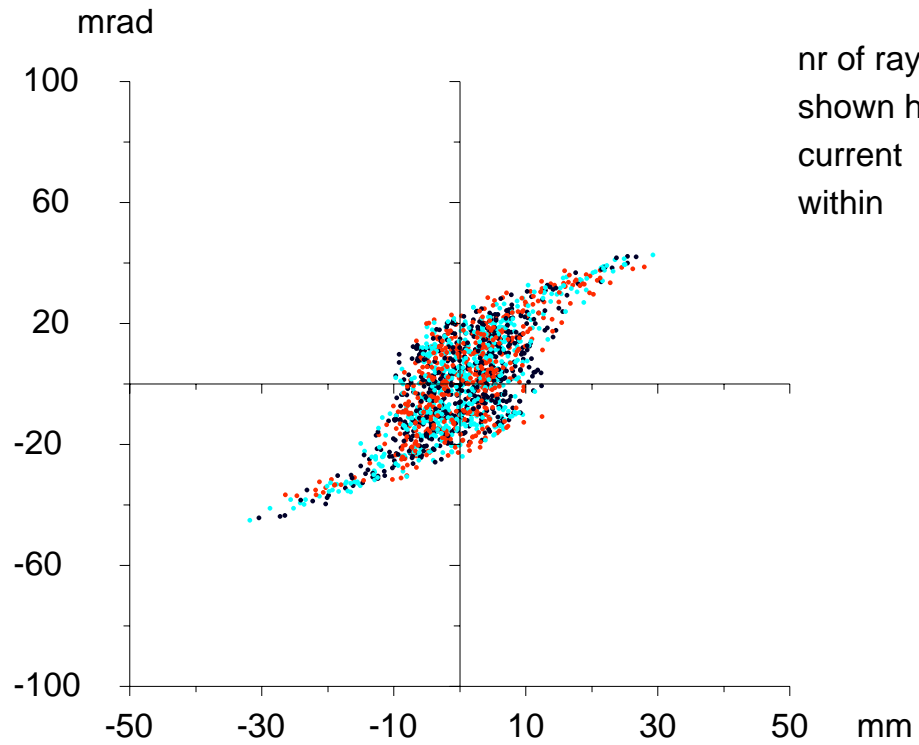

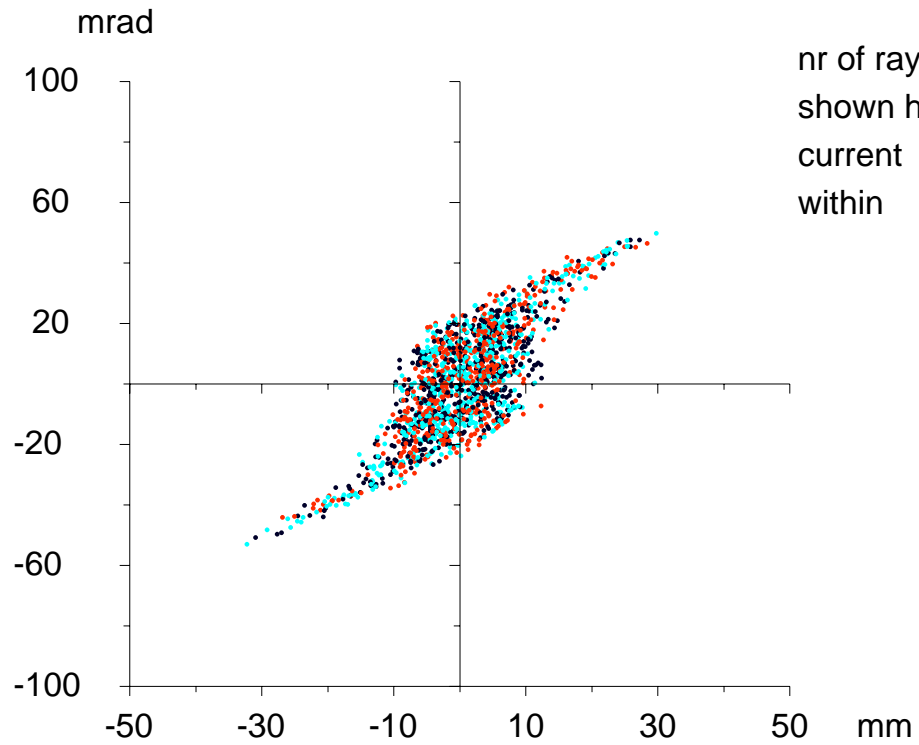
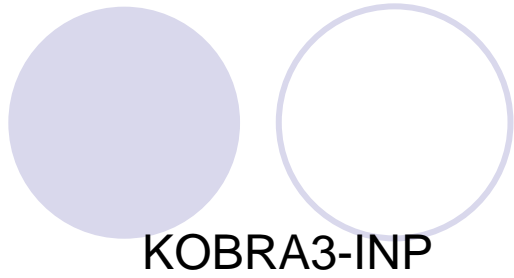



KOBRA3-INP



y emittance at 1.730 m

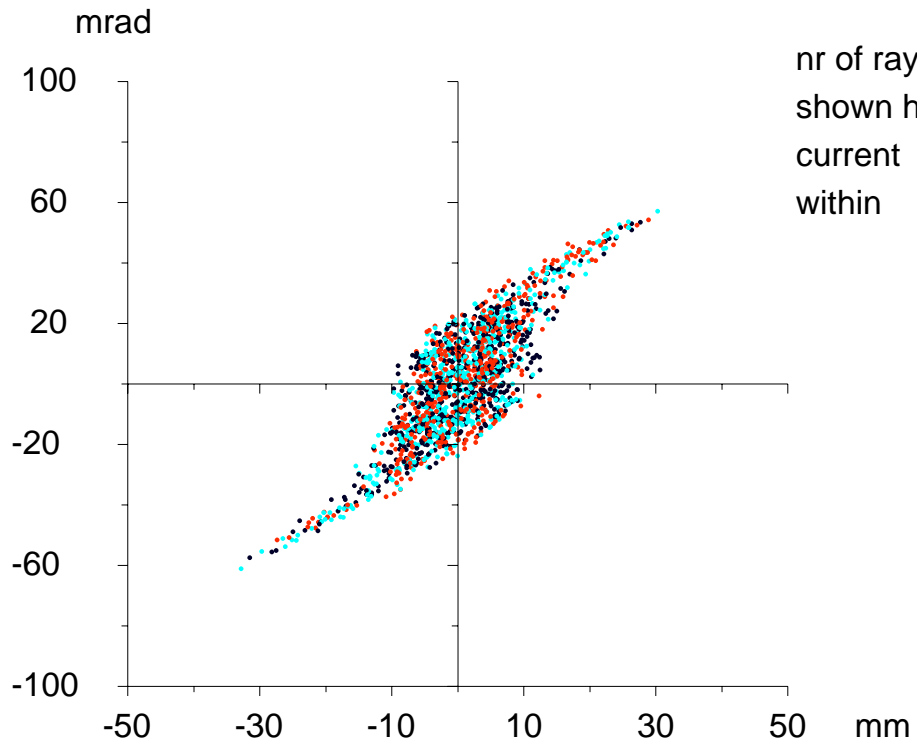

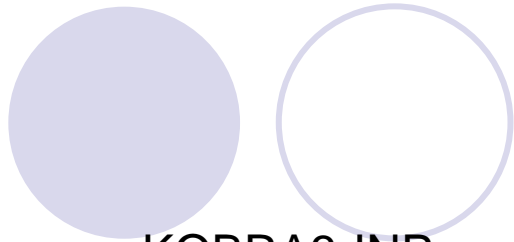

KOBRA3-INP

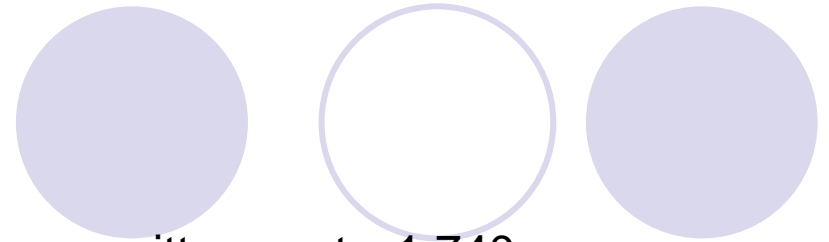

y emittance at 1.740 m

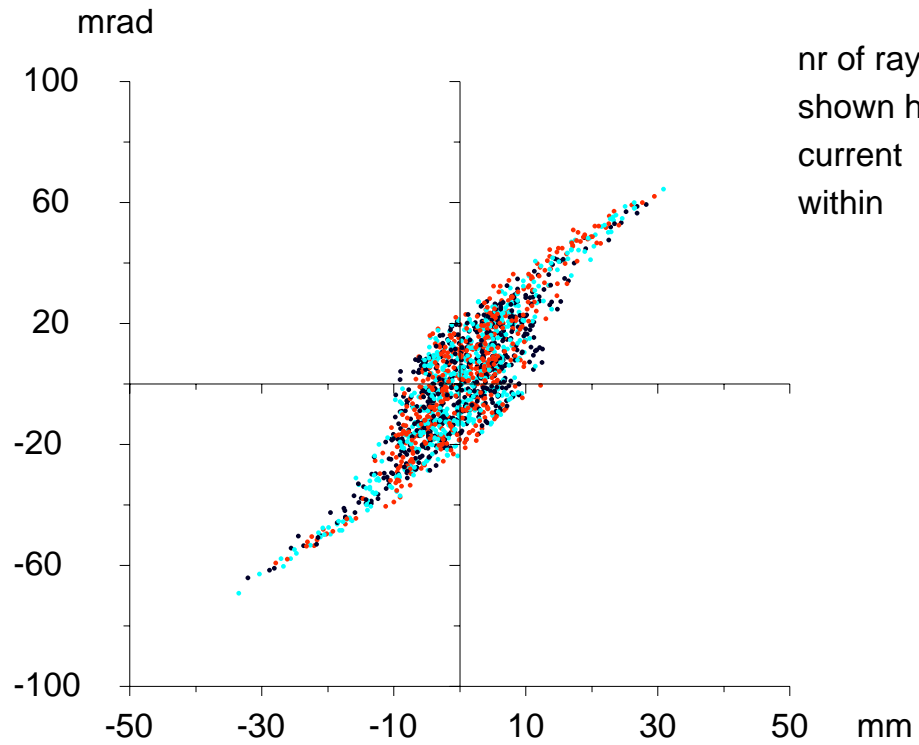

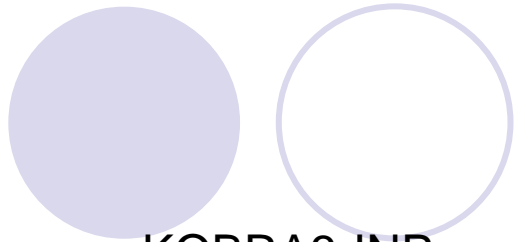

KOBRA3-INP



y emittance at 1.750 m

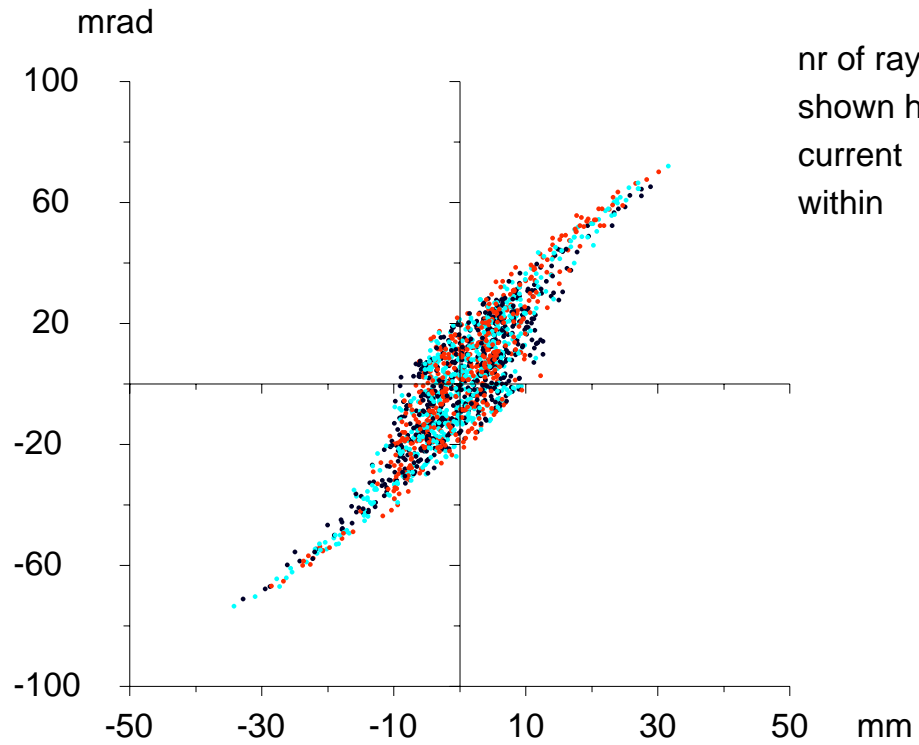

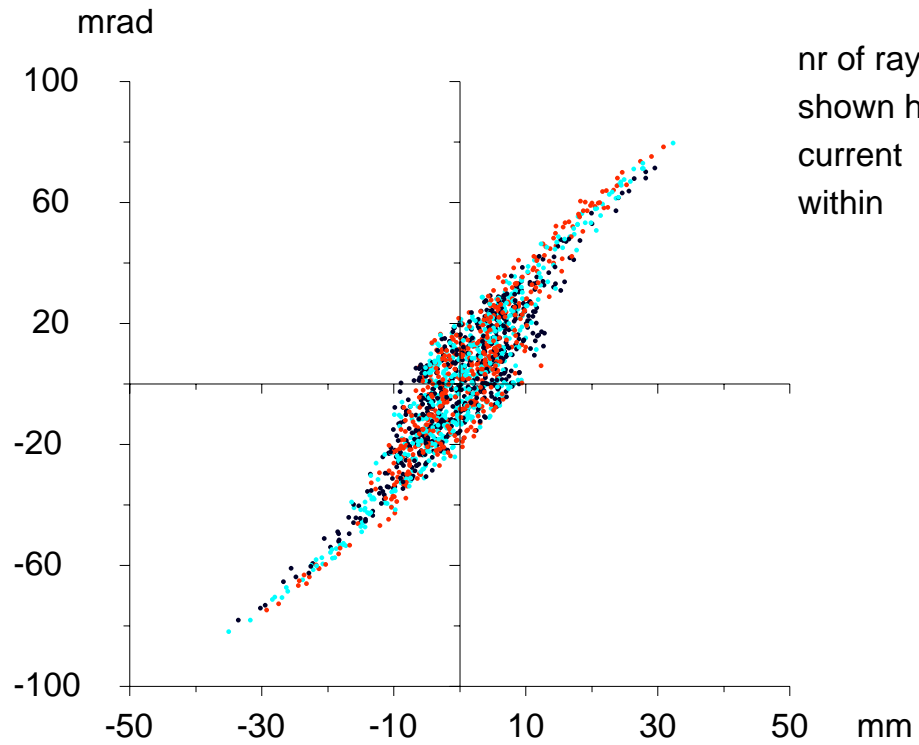
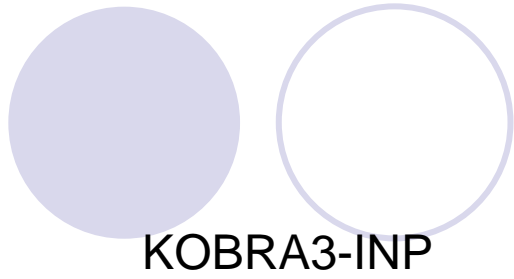

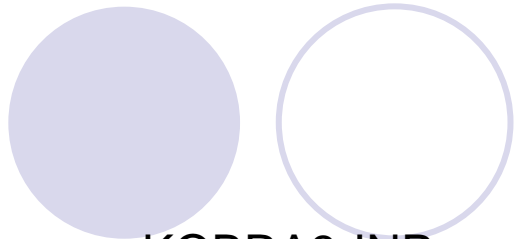

KOBRA3-INP

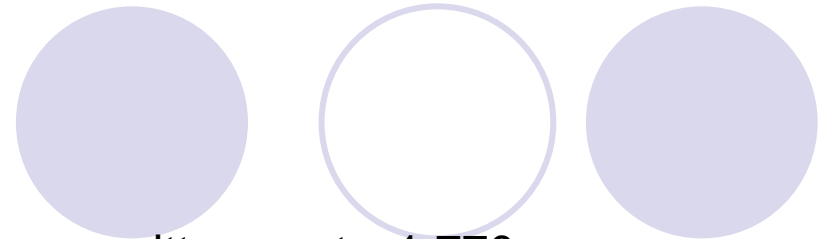

y emittance at 1.770 m

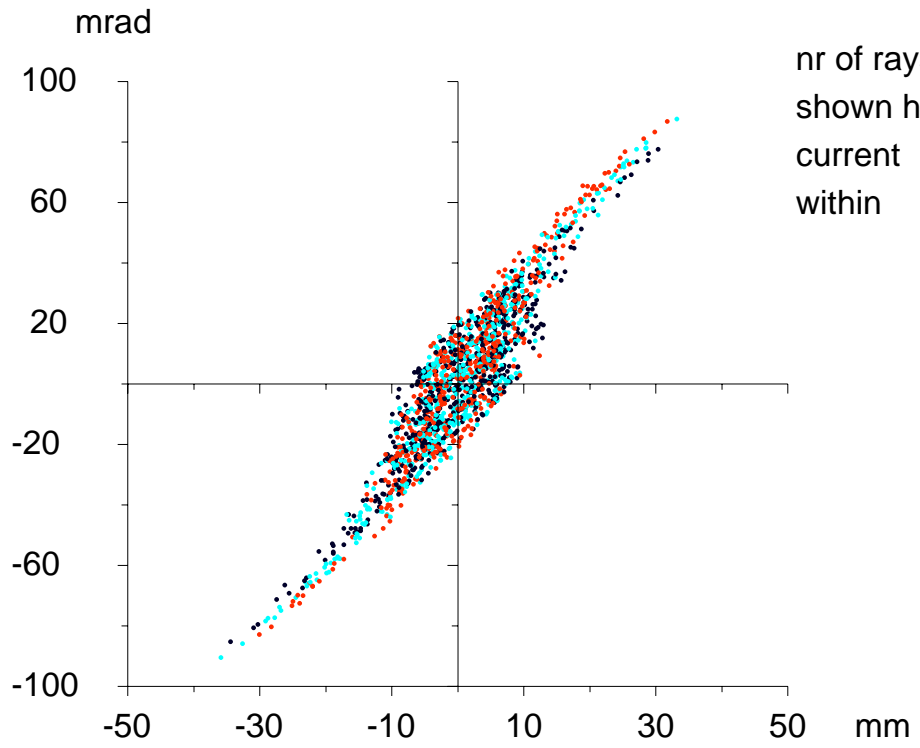



KOBRA3-INP

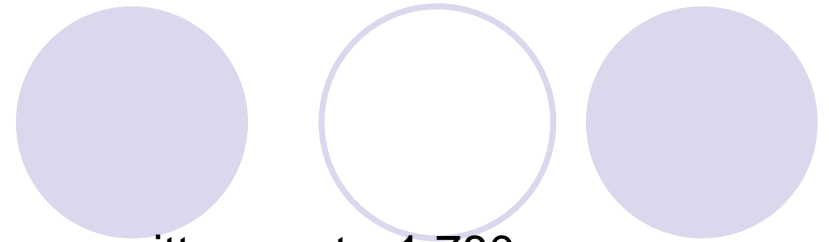

y emittance at 1.780 m

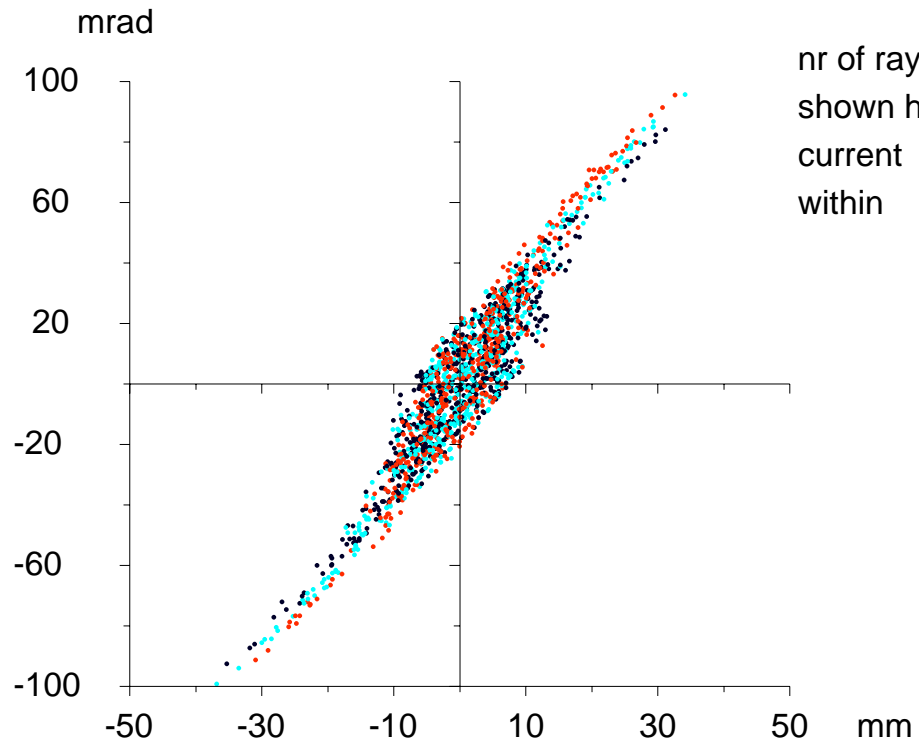



KOBRA3-INP

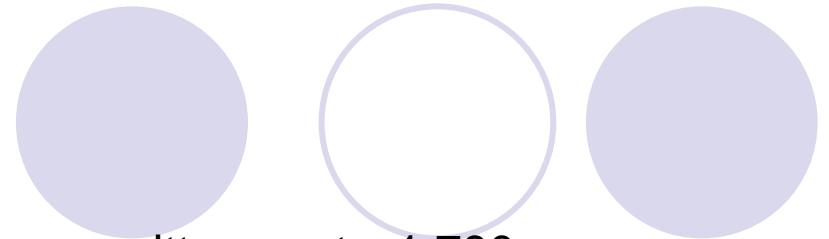

y emittance at 1.790 m

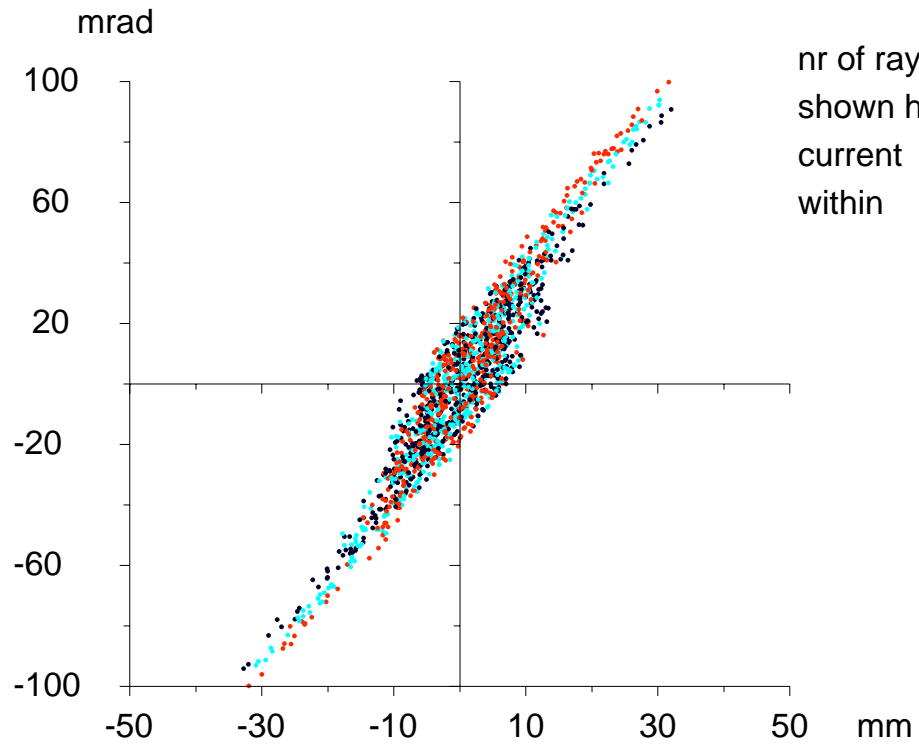

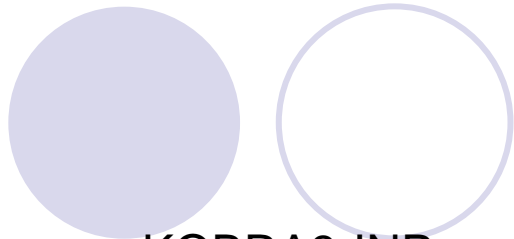

KOBRA3-INP

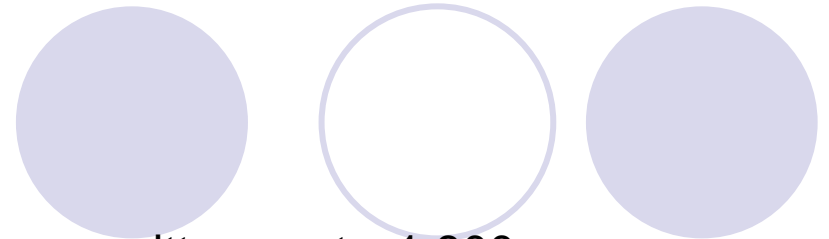

y emittance at 1.800 m

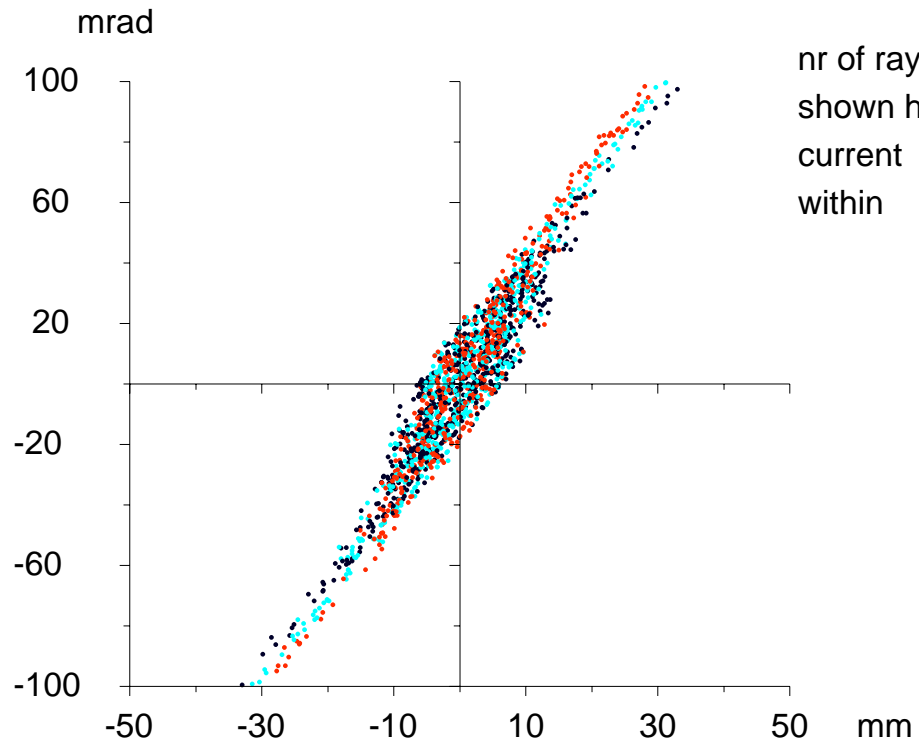



KOBRA3-INP

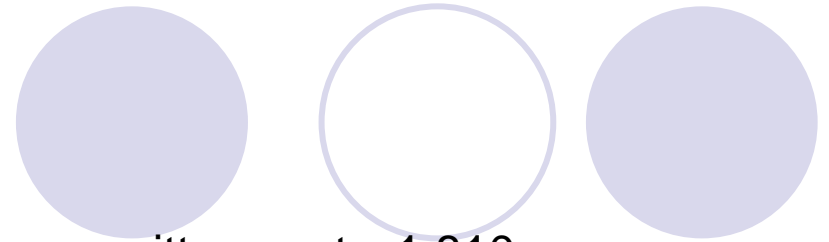

y emittance at 1.810 m

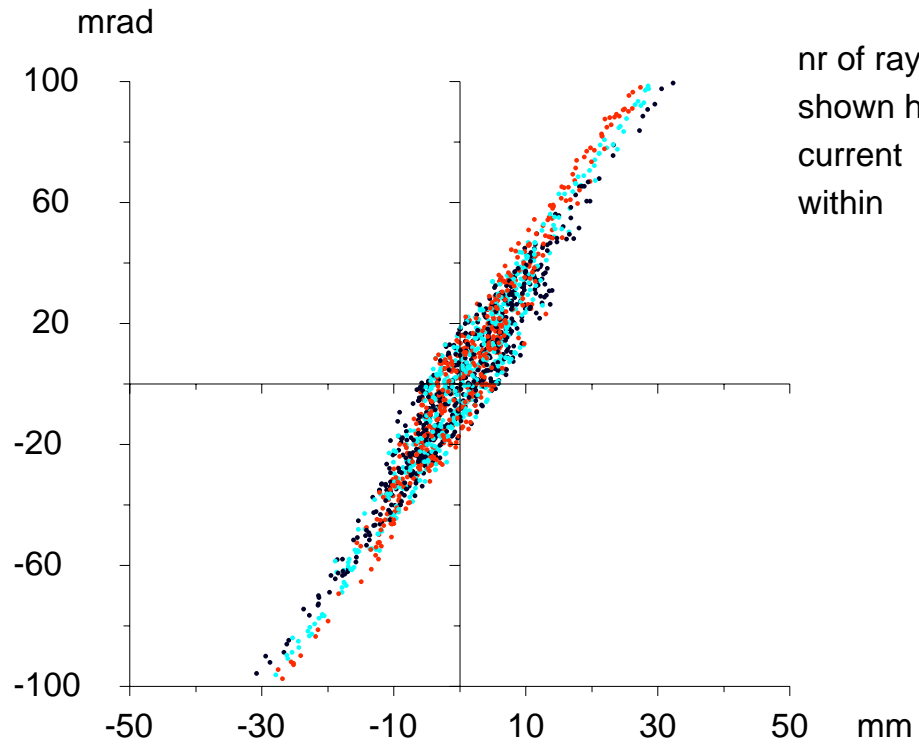

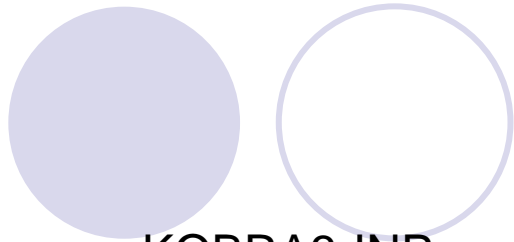

KOBRA3-INP

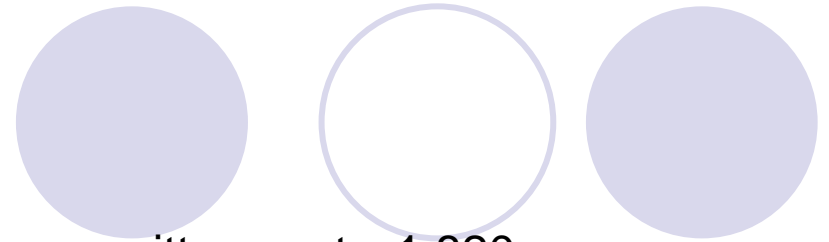

y emittance at 1.820 m

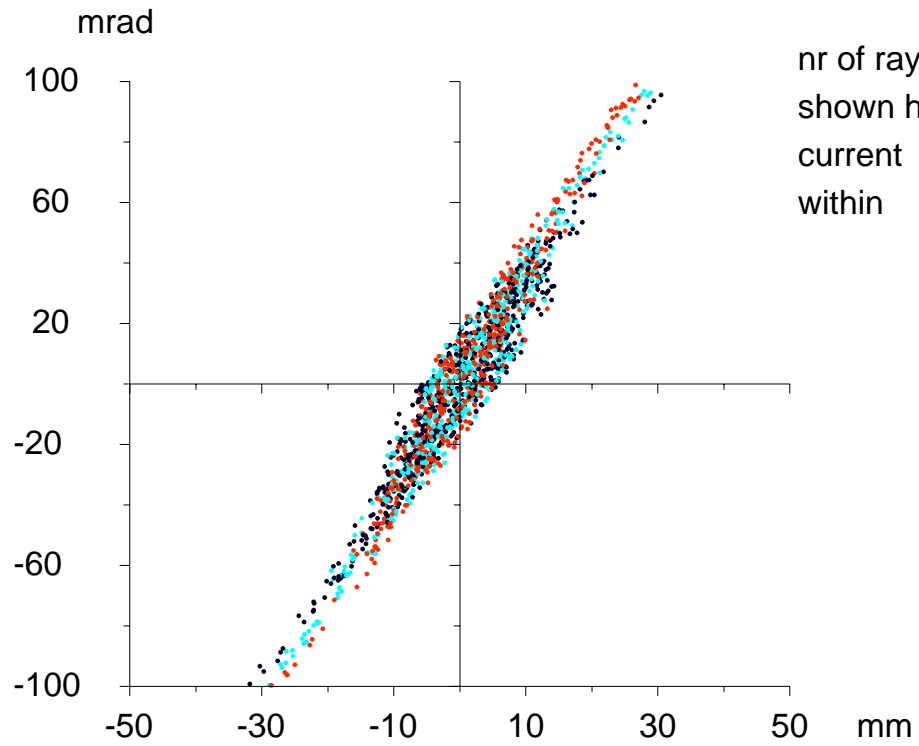

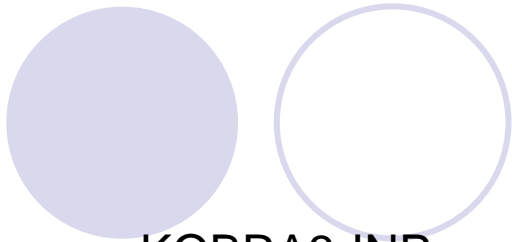

KOBRA3-INO

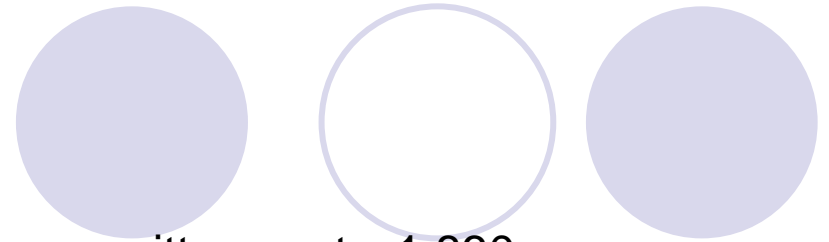

y emittance at 1.830 m

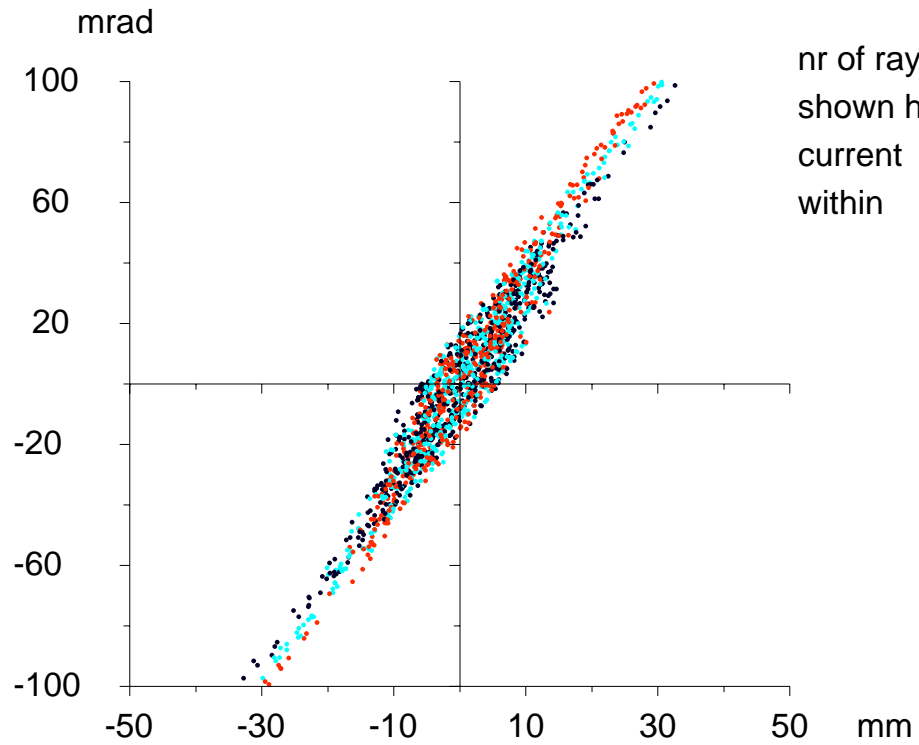



KOBRA3-INP

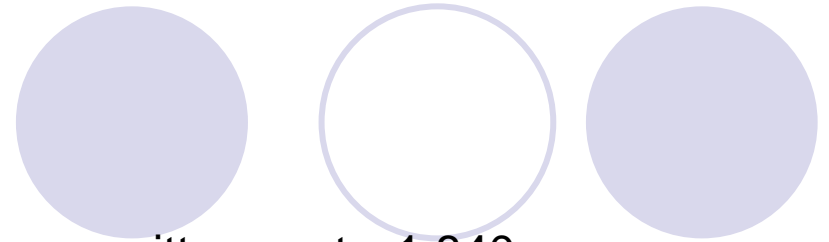

y emittance at 1.840 m

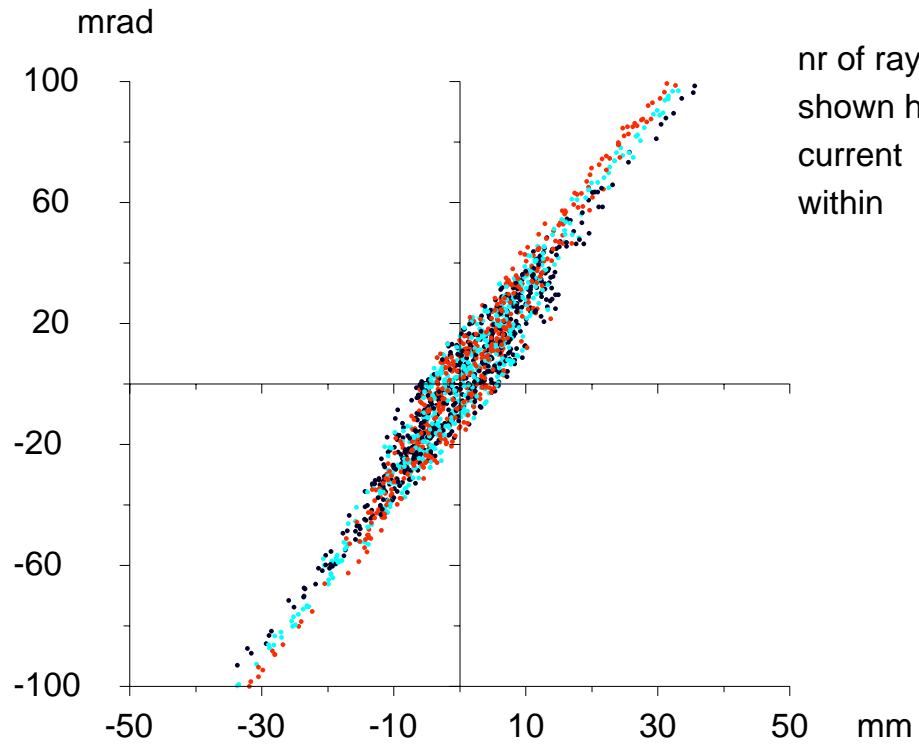

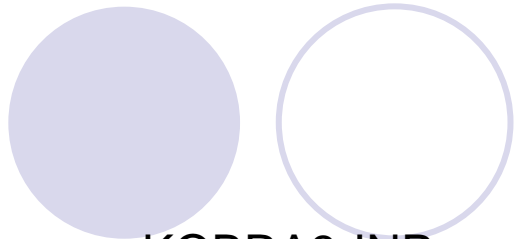

KOBRA3-INP

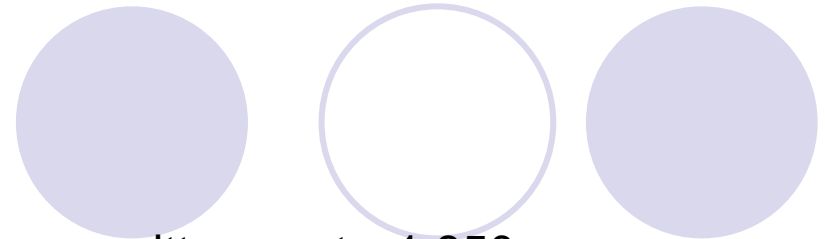

y emittance at 1.850 m

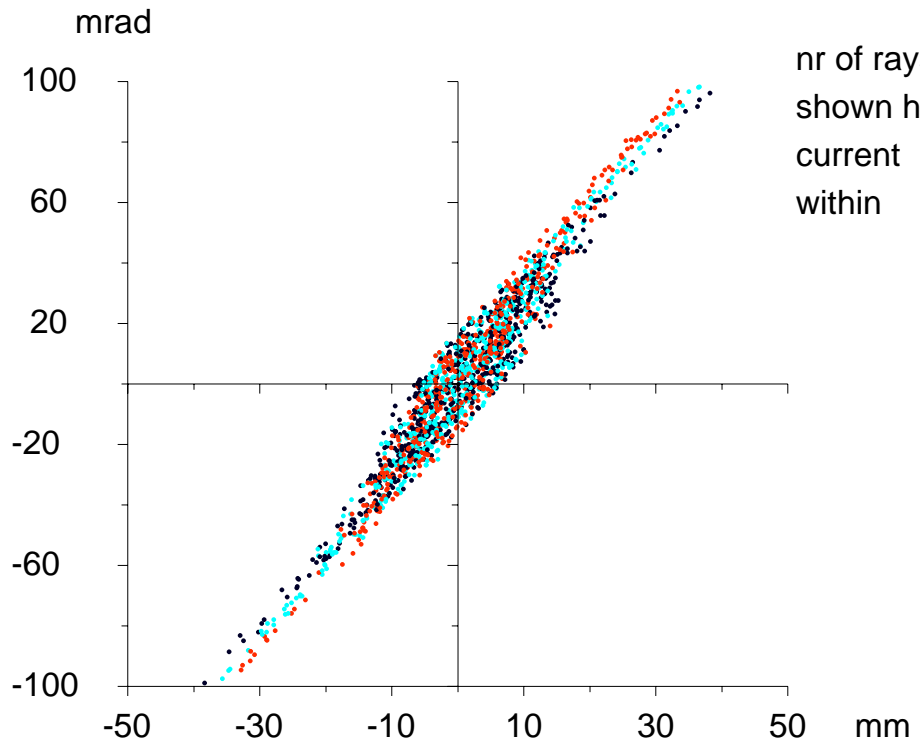



KOBRA3-INP

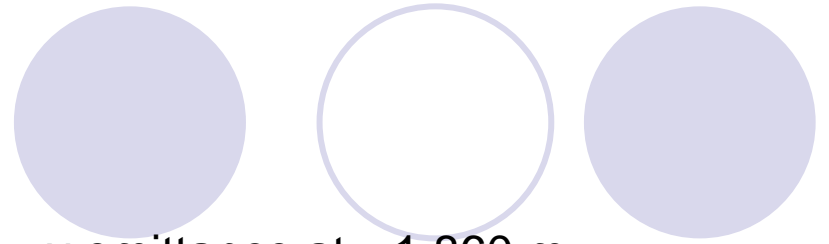

y emittance at 1.860 m

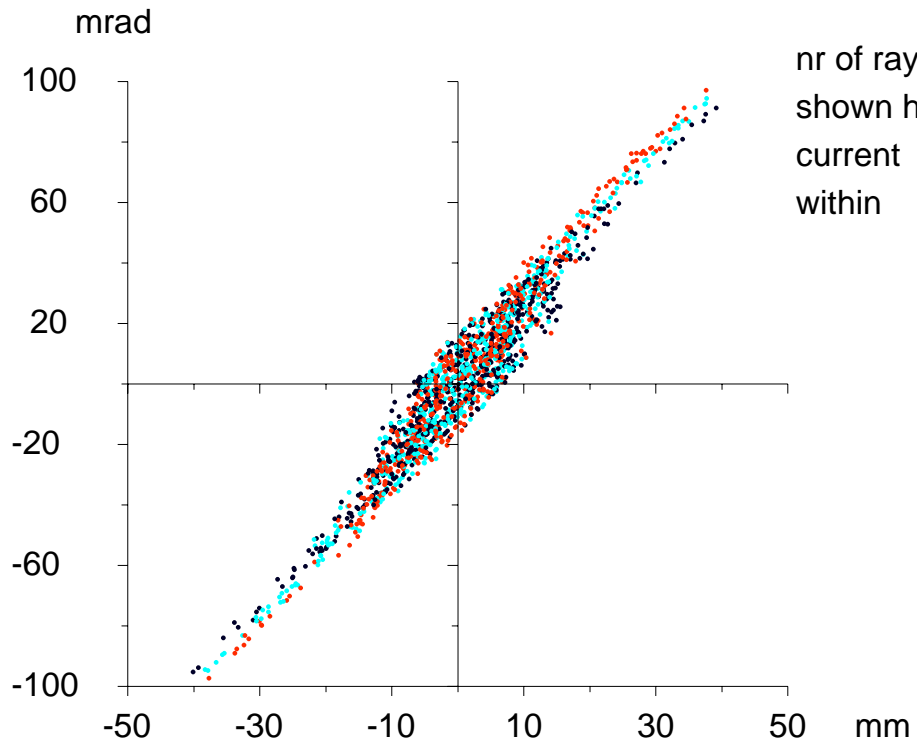



KOBRA3-INP

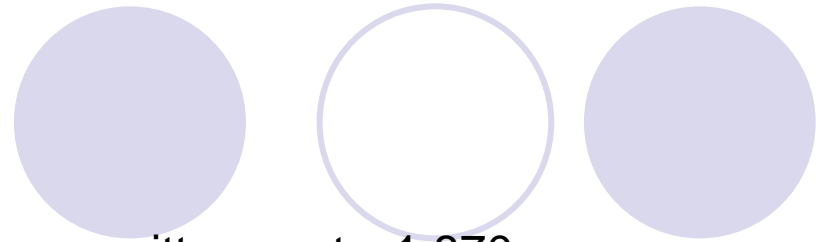

y emittance at 1.870 m

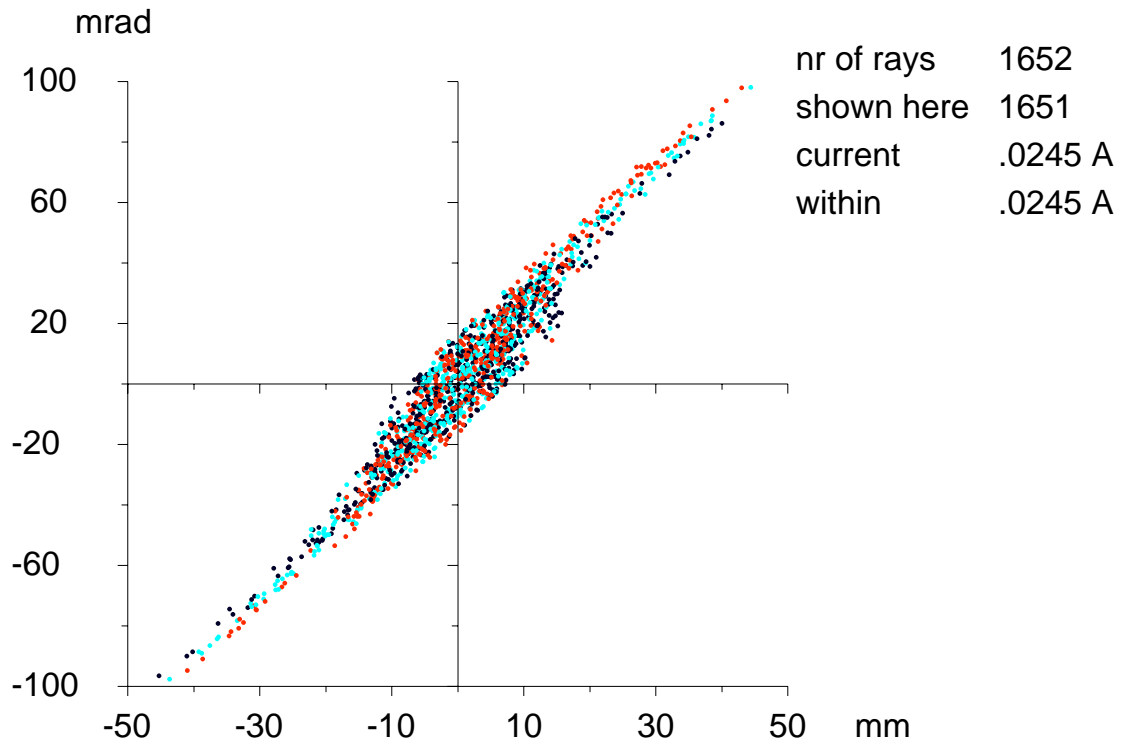

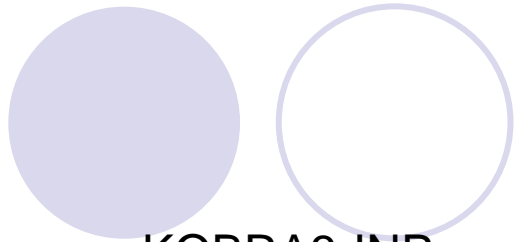

KOBRA3-INP

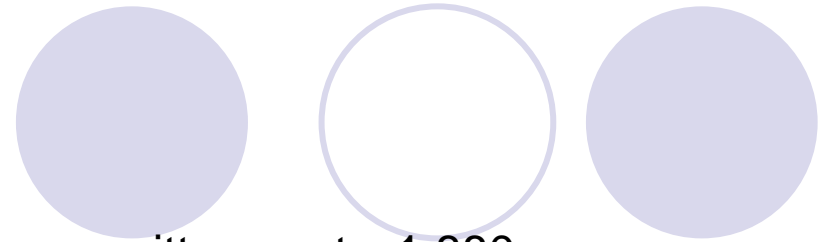

y emittance at 1.880 m

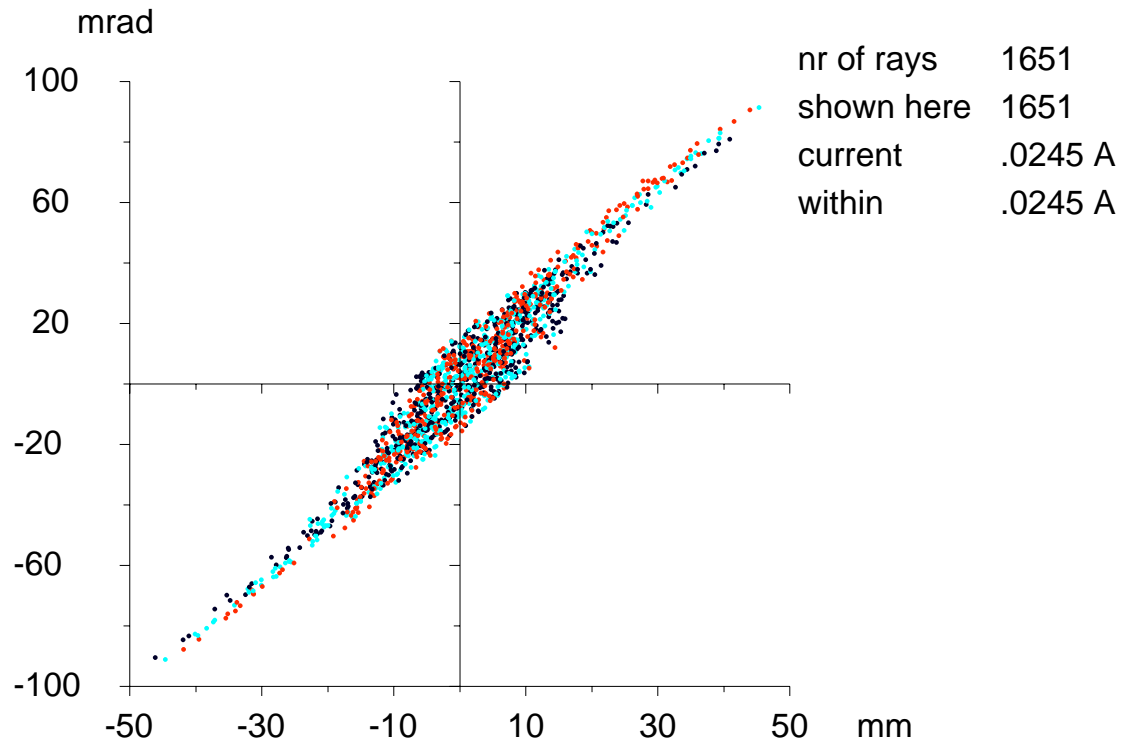



KOBRA3-INP

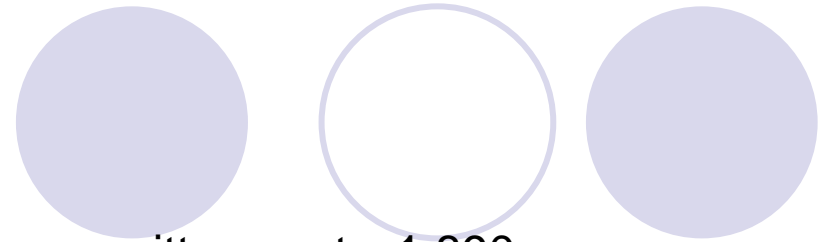

y emittance at 1.890 m

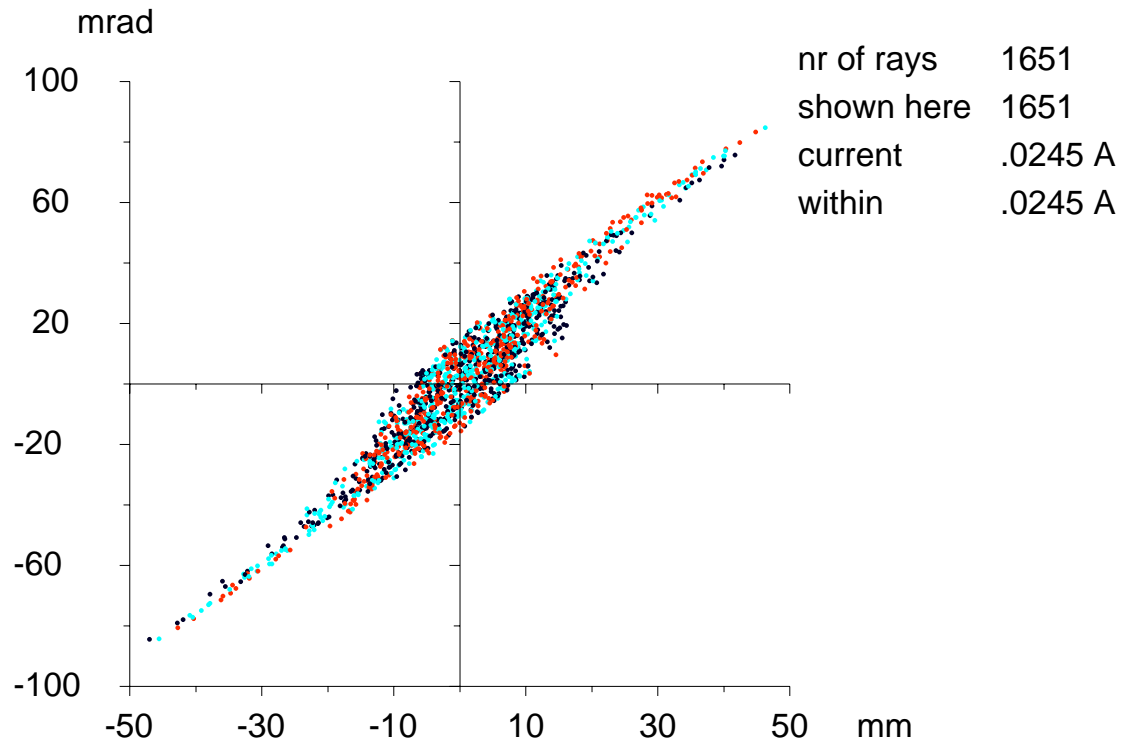



KOBRA3-INP

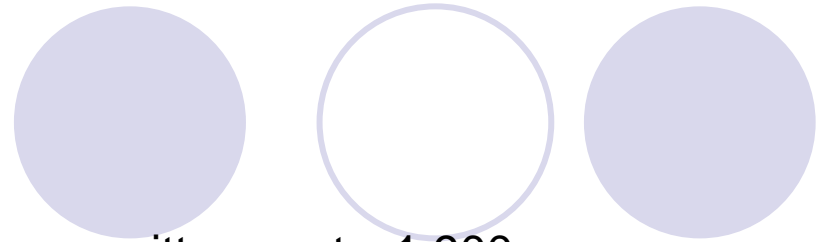

y emittance at 1.900 m

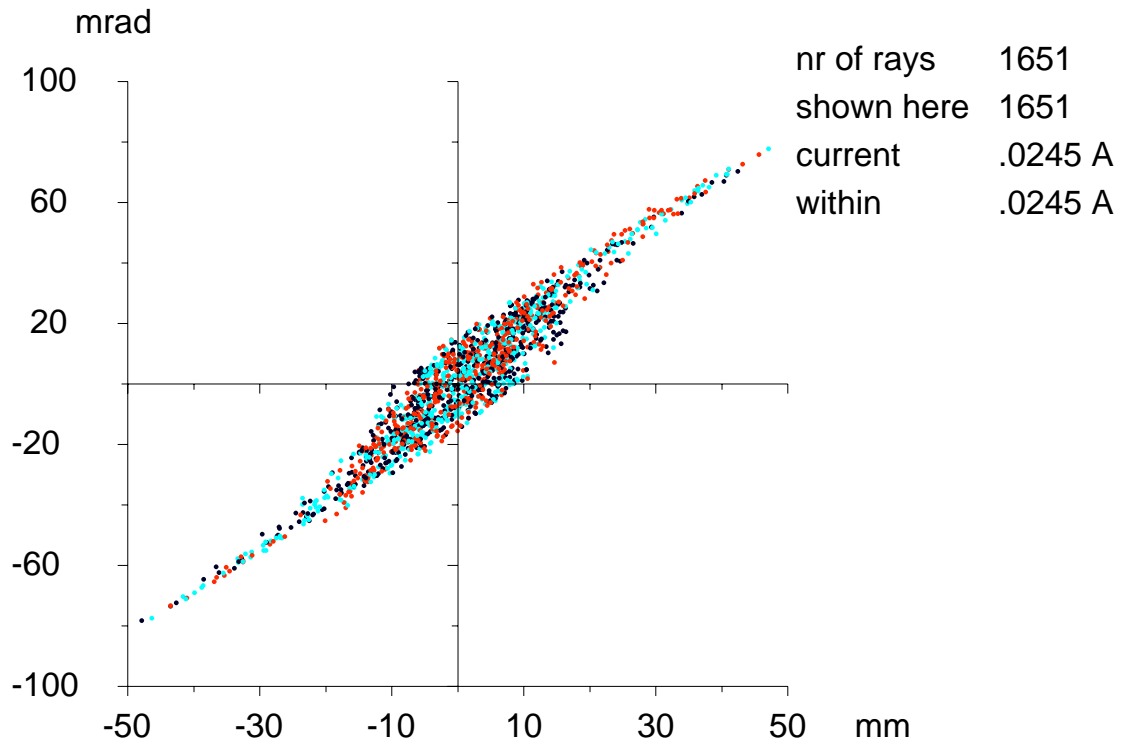



KOBRA3-INP



y emittance at 1.910 m

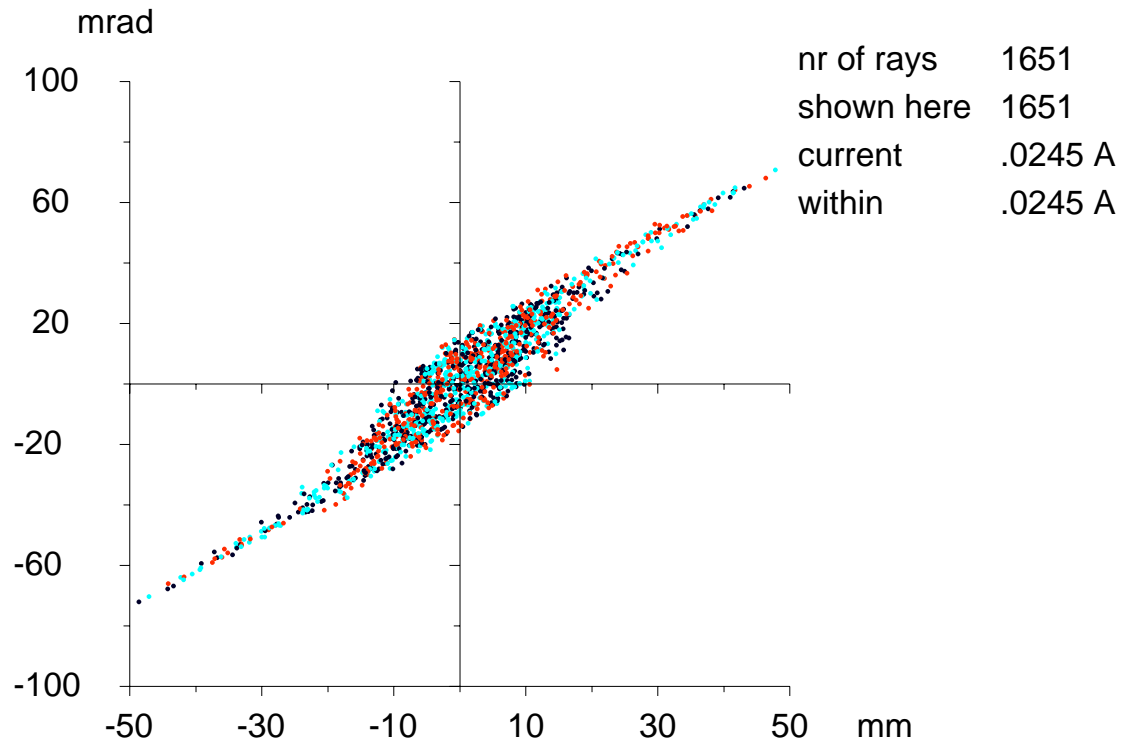



KOBRA3-INP

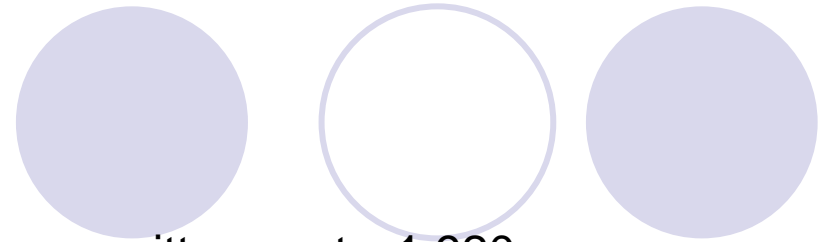

y emittance at 1.920 m

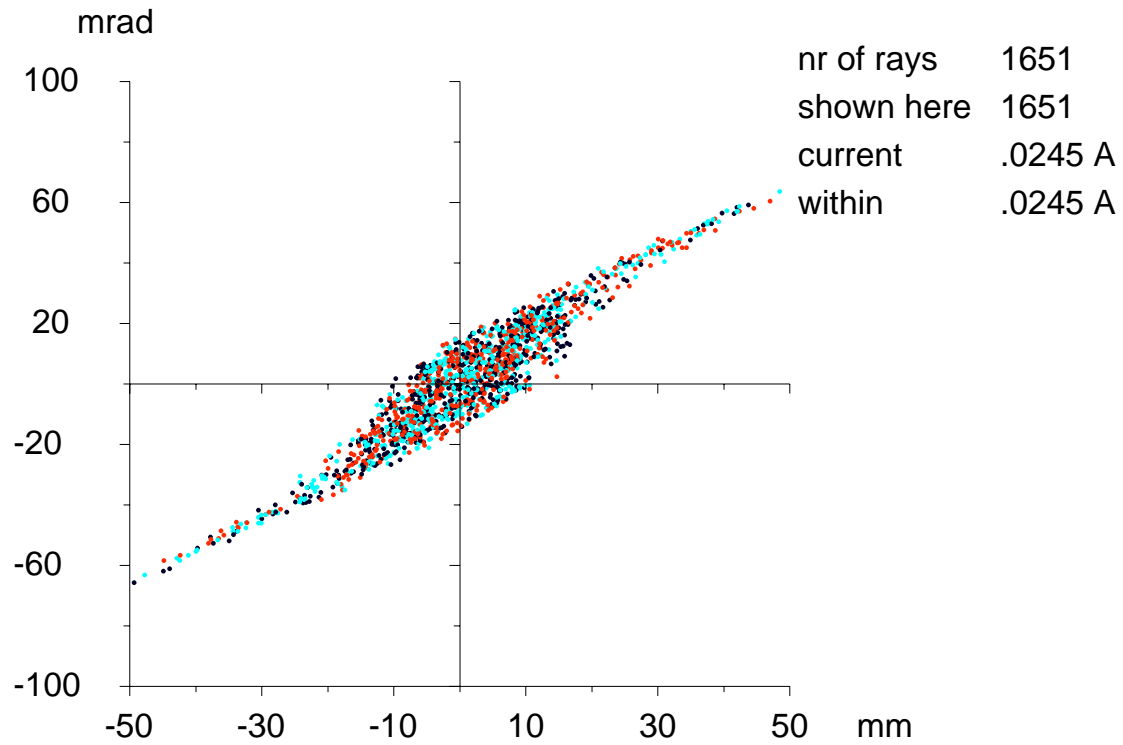

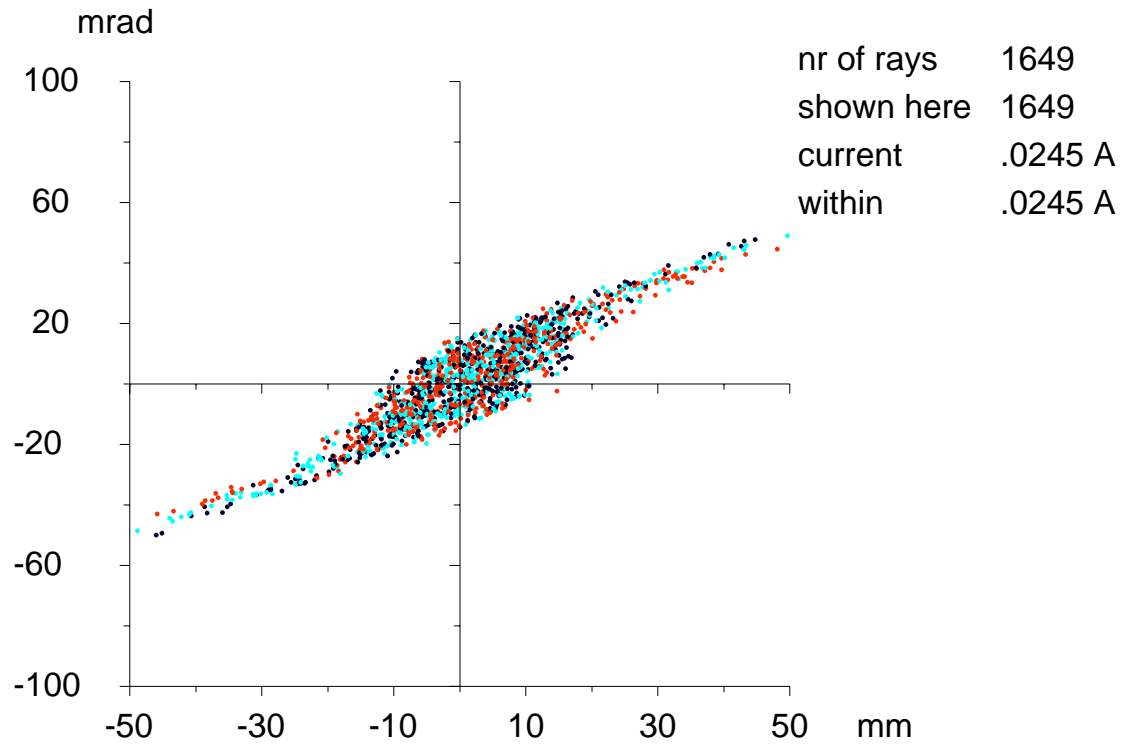
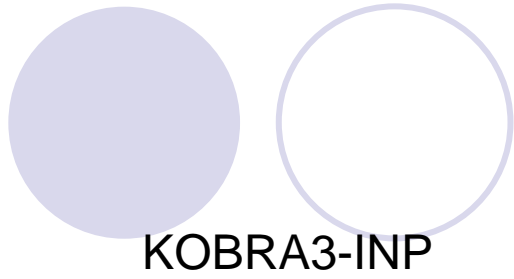

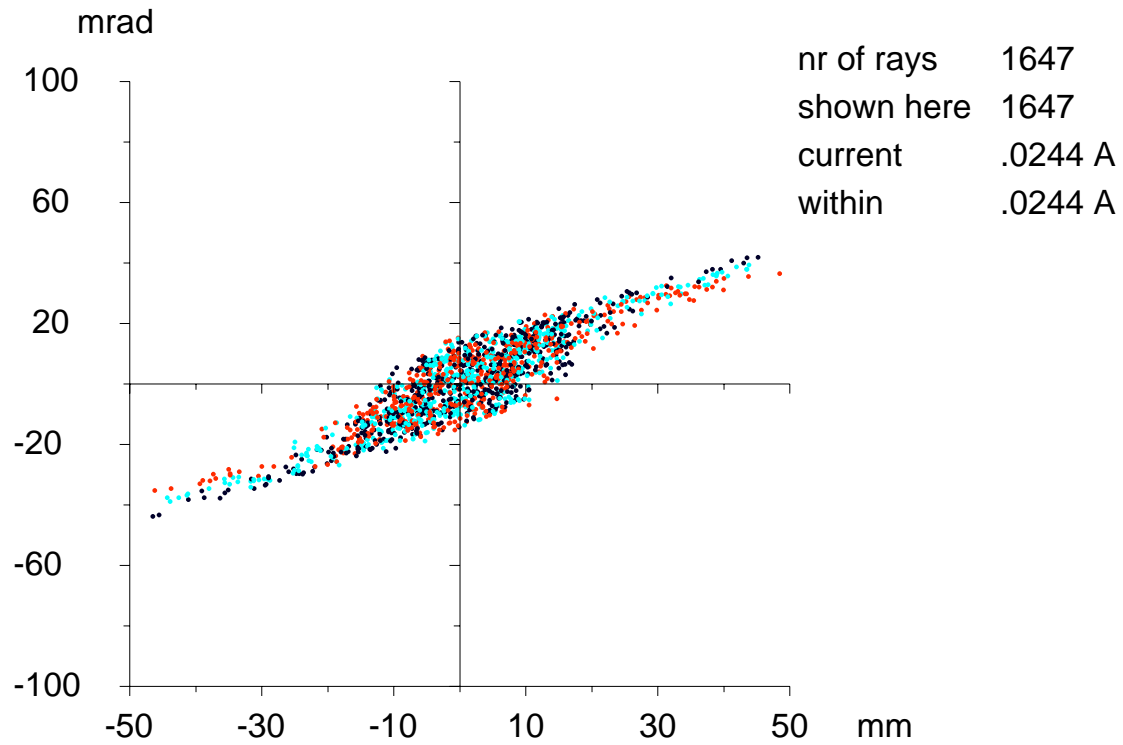
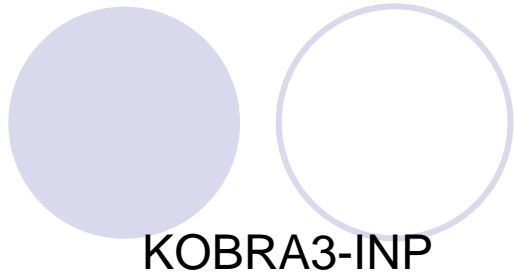

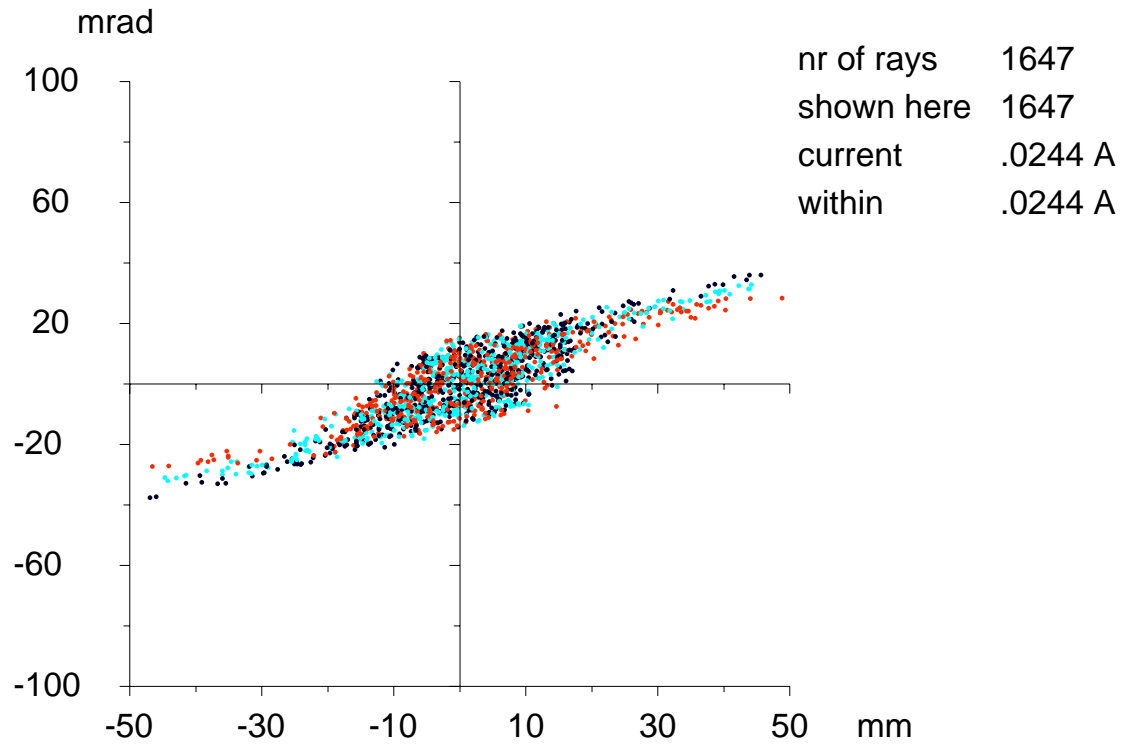
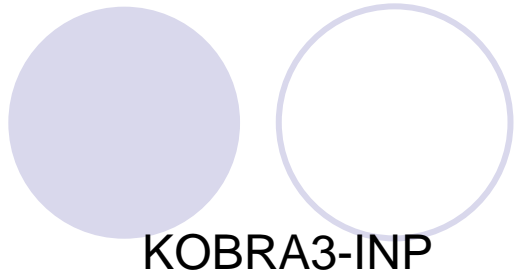

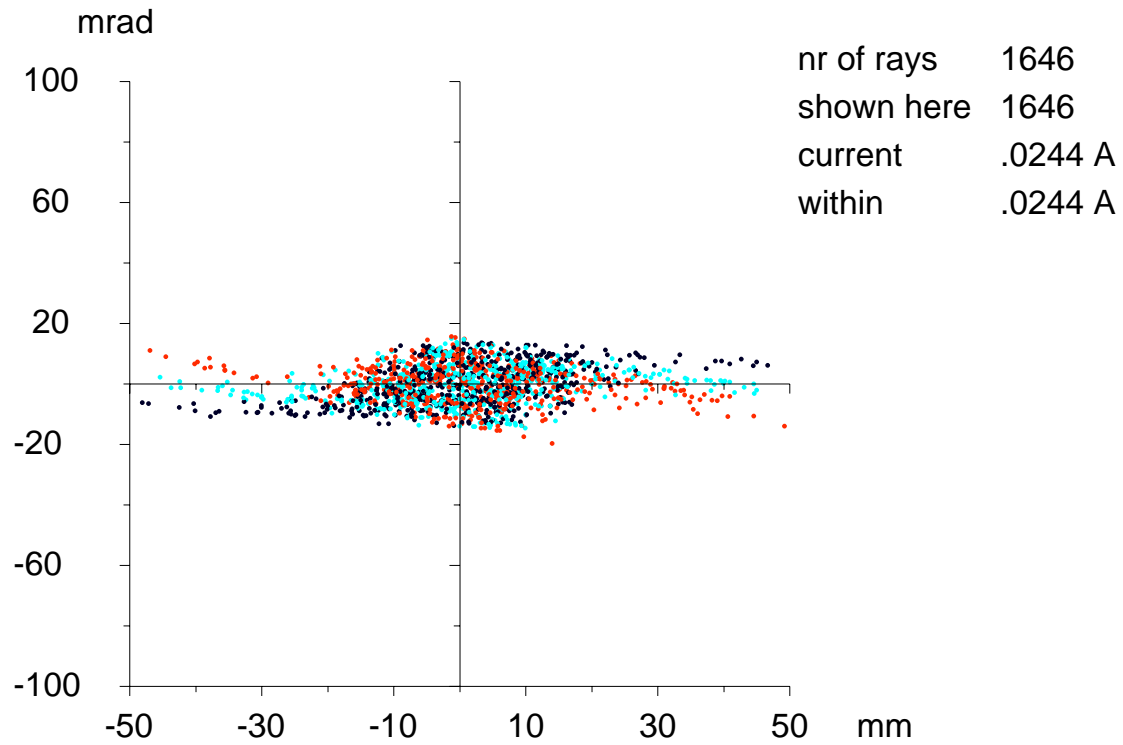
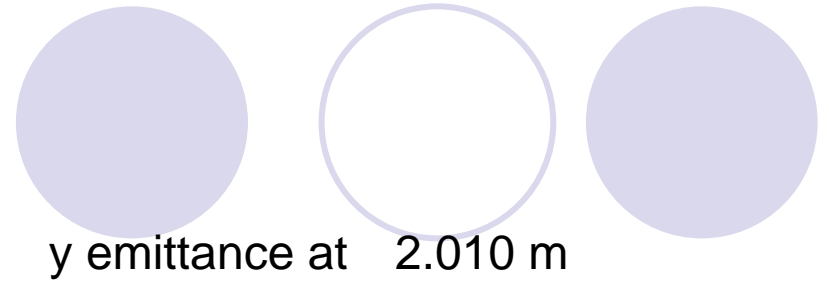
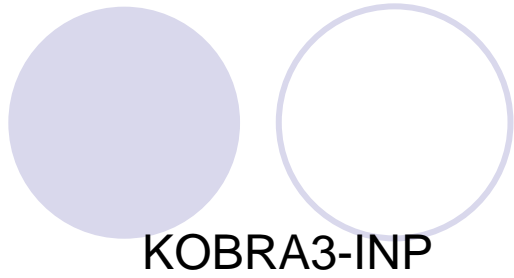



KOBRA3-INP



y emittance at 2.060 m

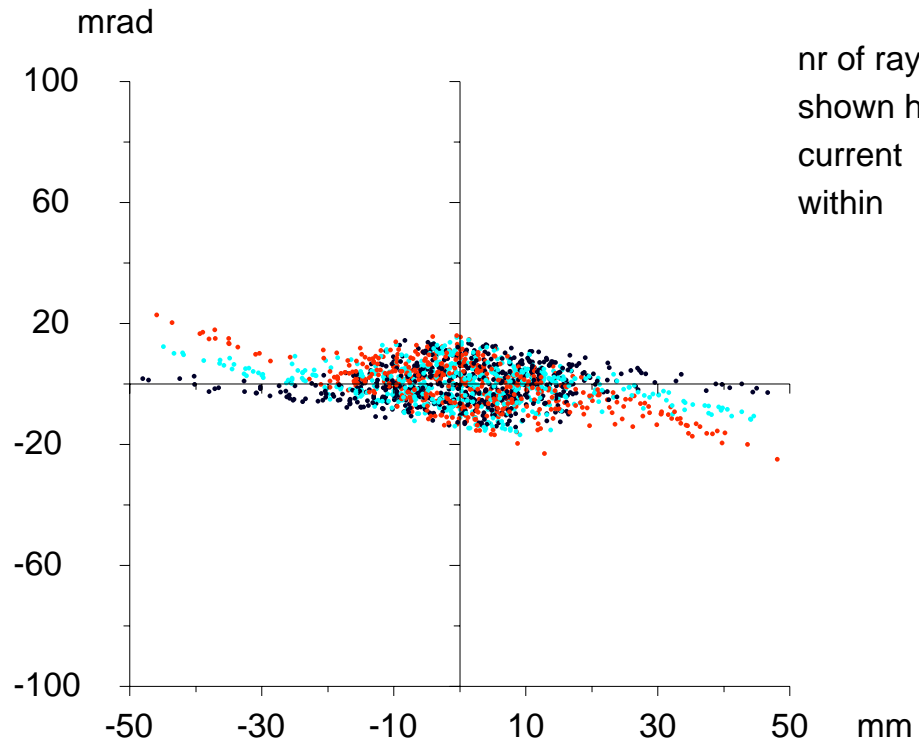



KOBRA3-INP

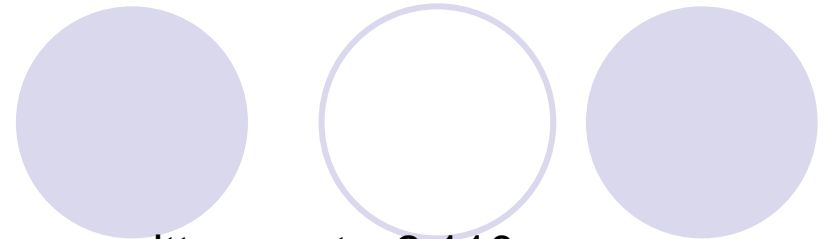

y emittance at 2.110 m

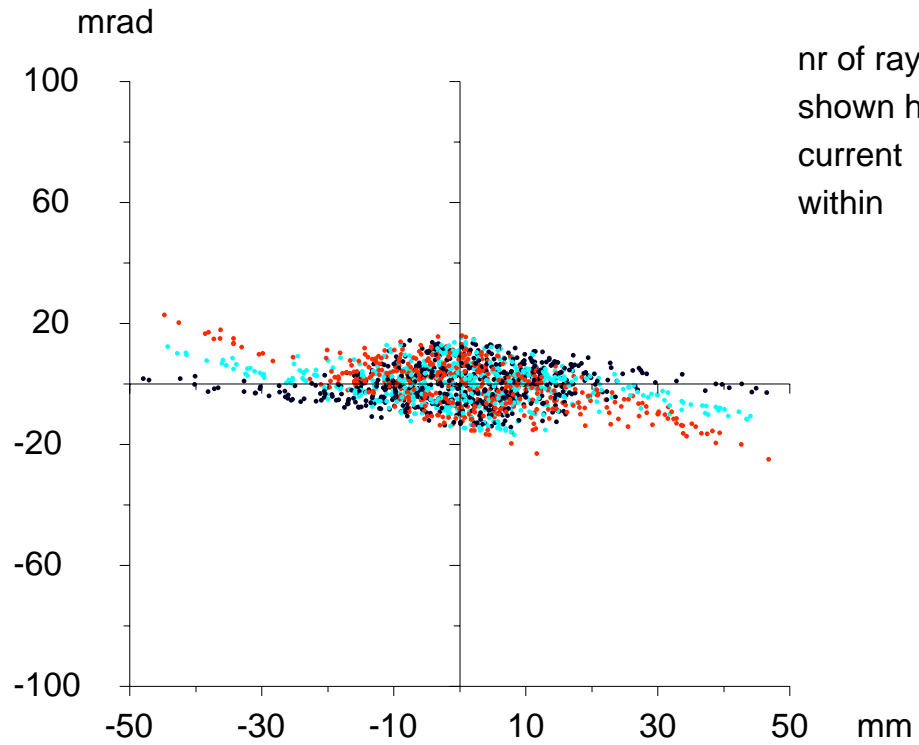



KOBRA3-INP

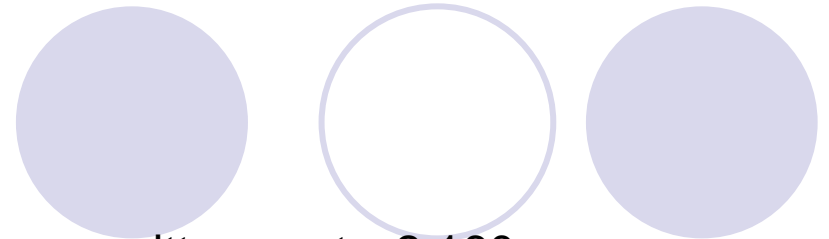

y emittance at 2.160 m

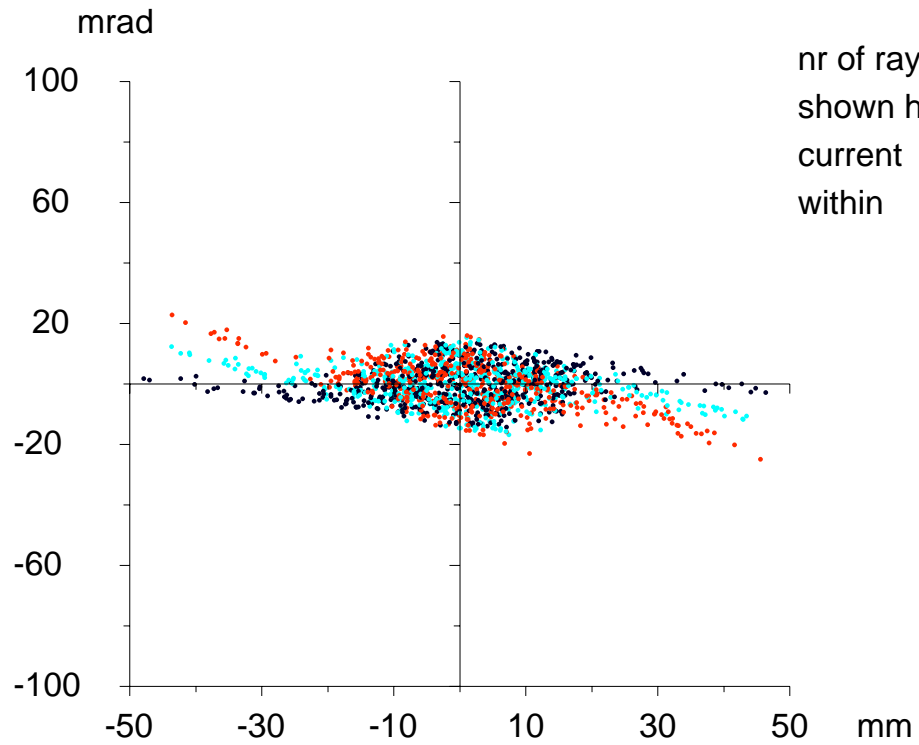



KOBRA3-INP

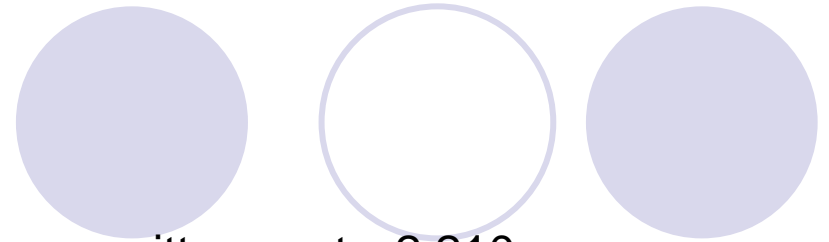

y emittance at 2.210 m

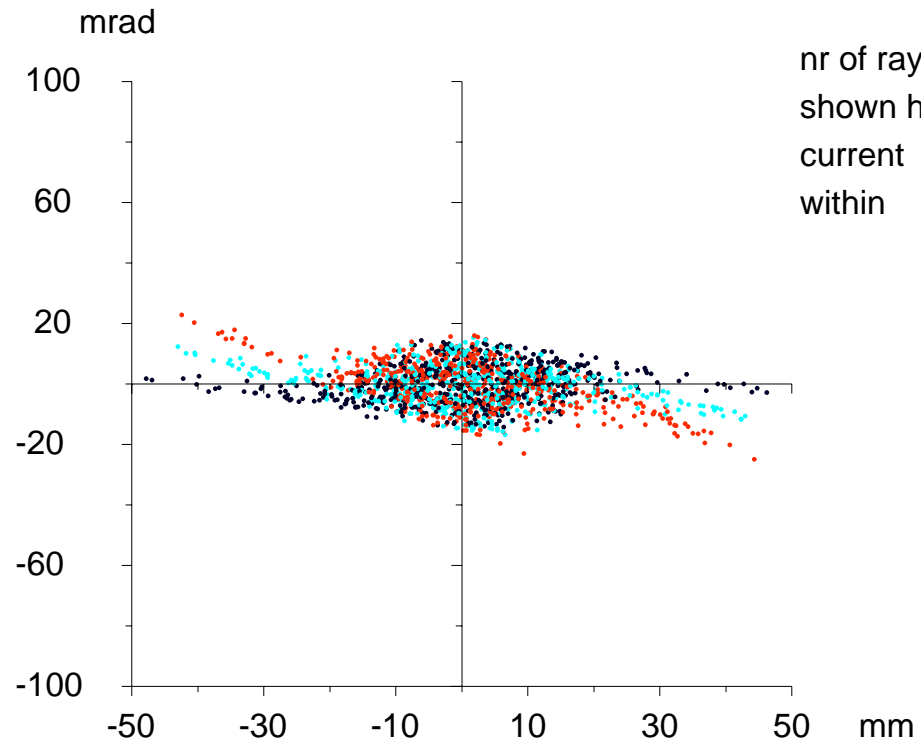

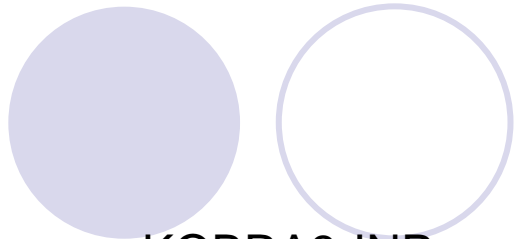

KOBRA3-INP

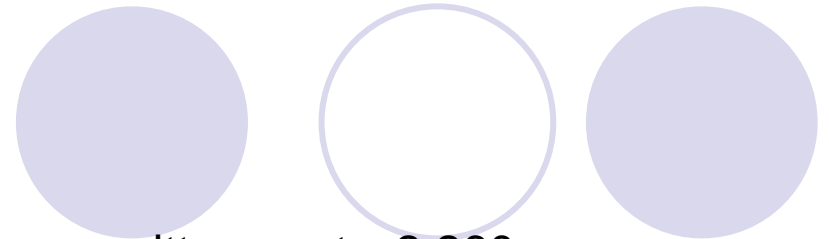

y emittance at 2.260 m

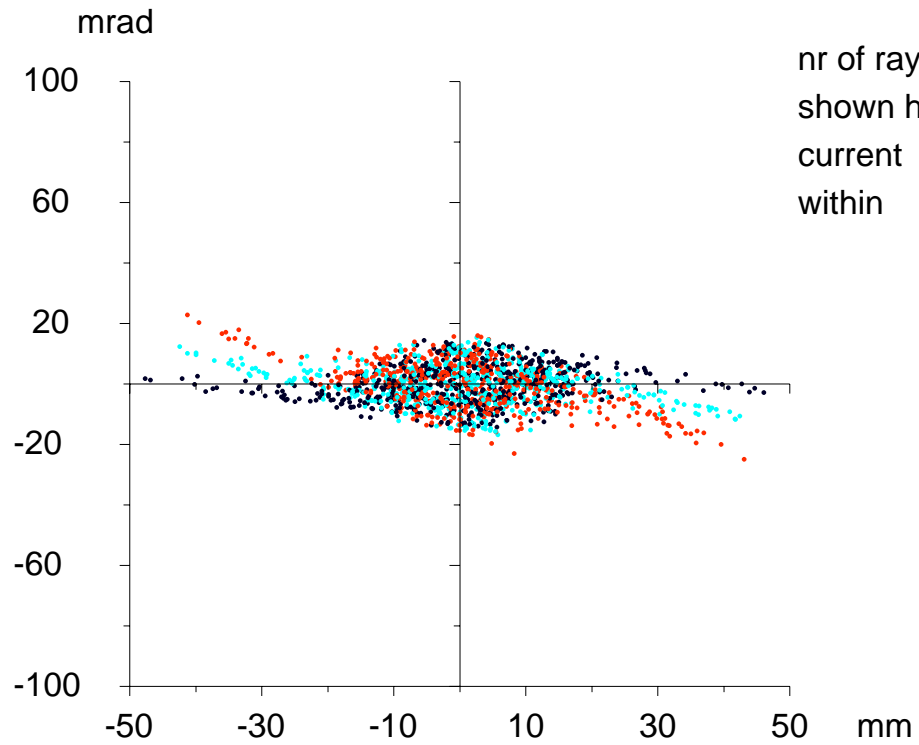

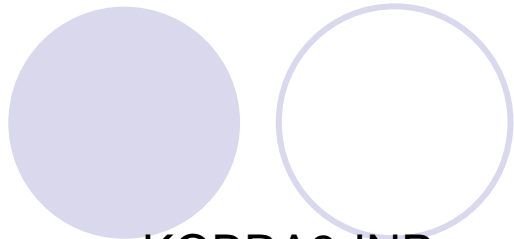

KOBRA3-INP

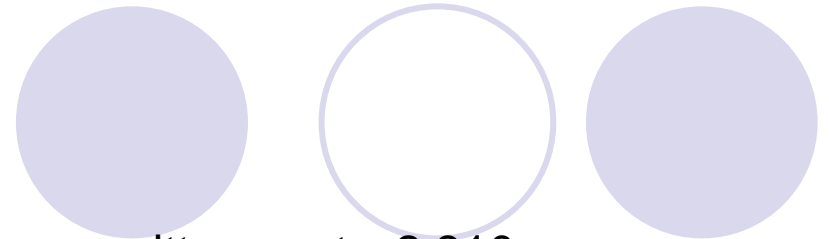

y emittance at 2.310 m

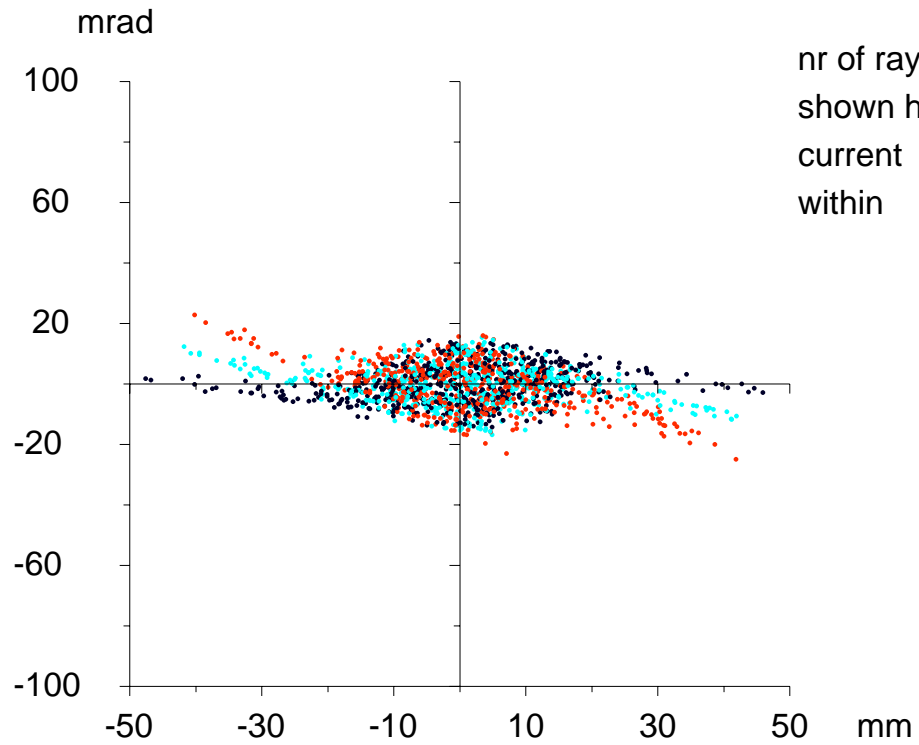

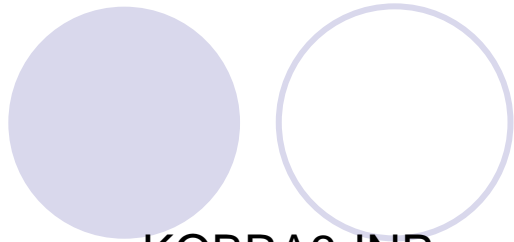

KOBRA3-INP

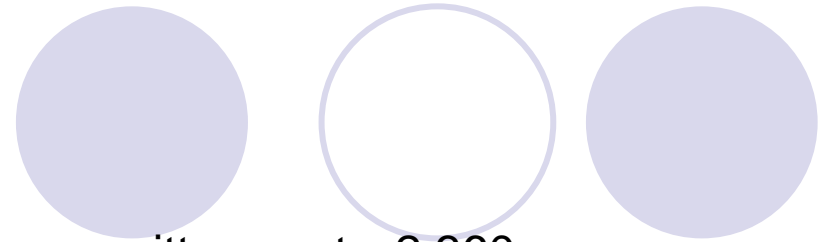

y emittance at 2.360 m

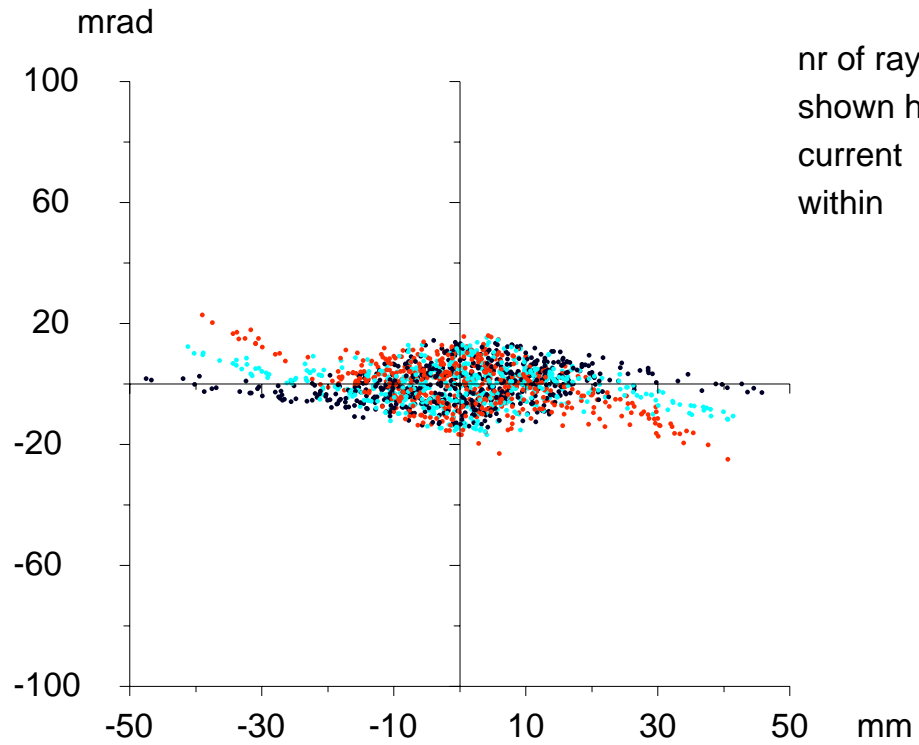

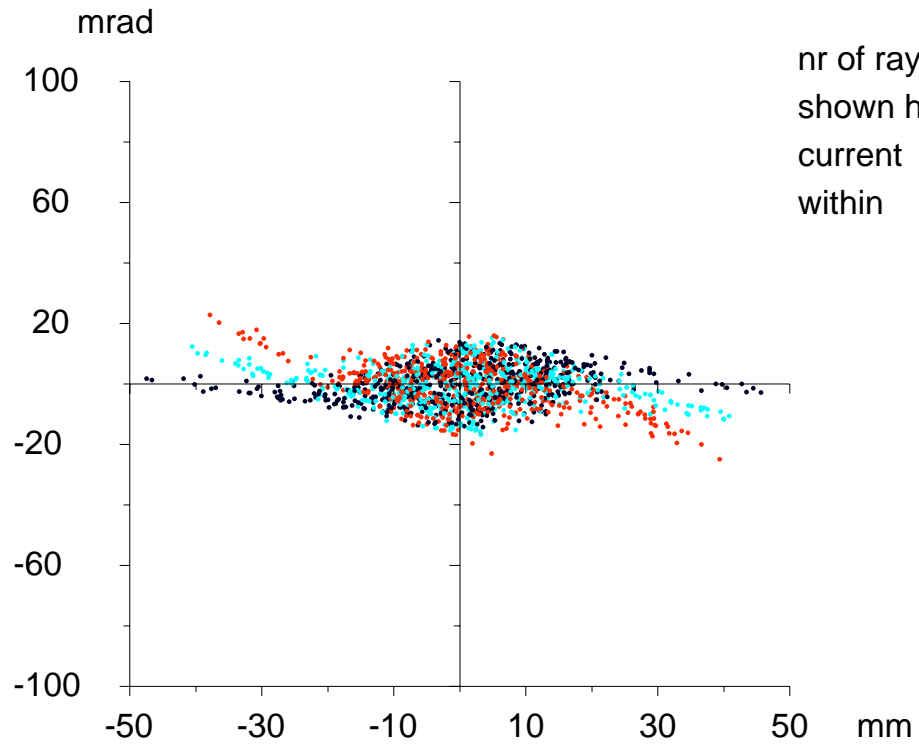
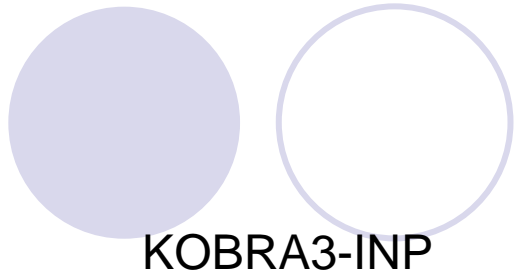



KOBRA3-INP



y emittance at 2.460 m

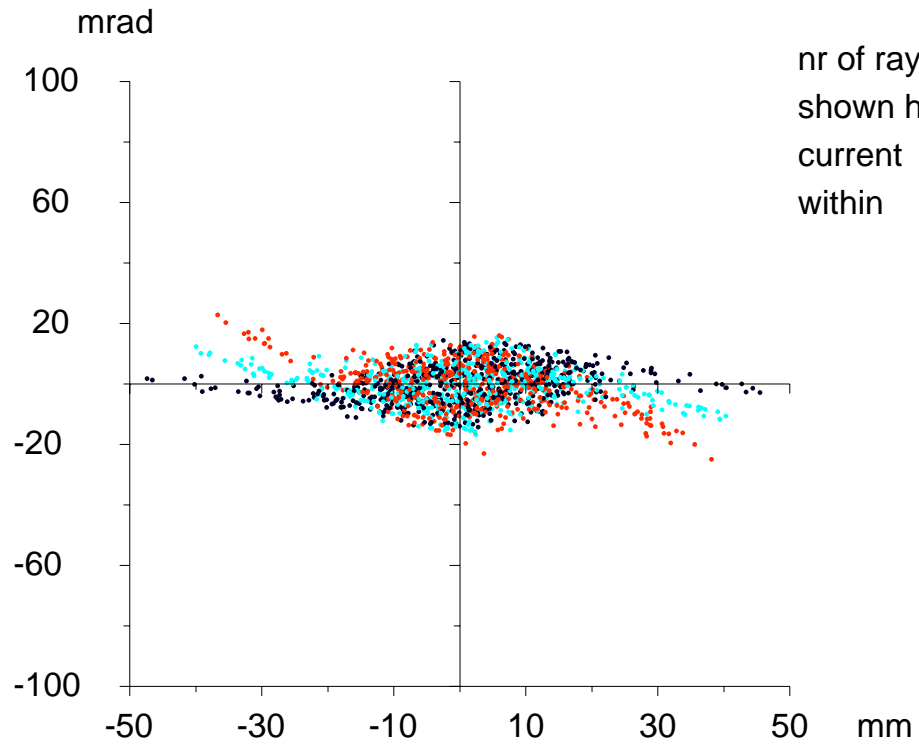

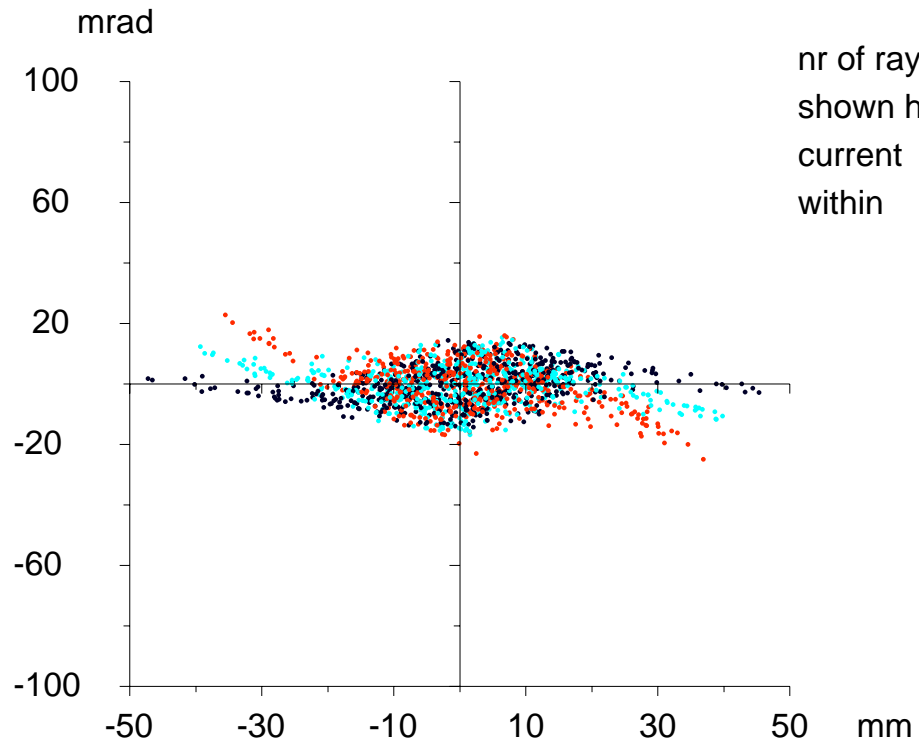
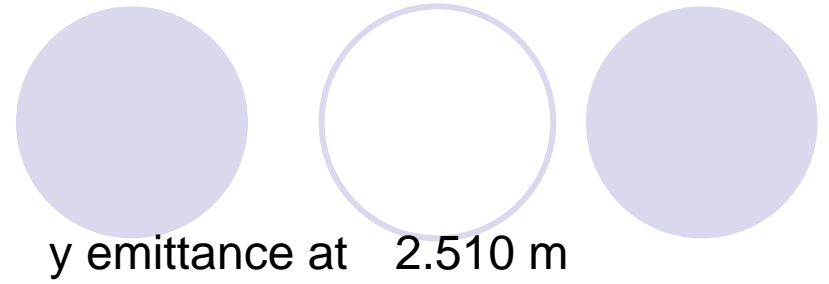
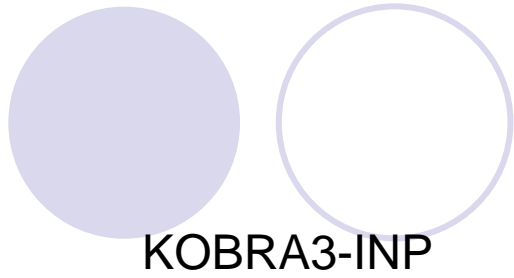

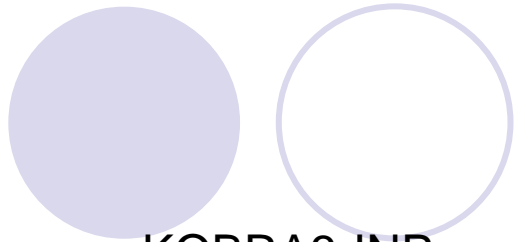

KOBRA3-INP



y emittance at 2.560 m

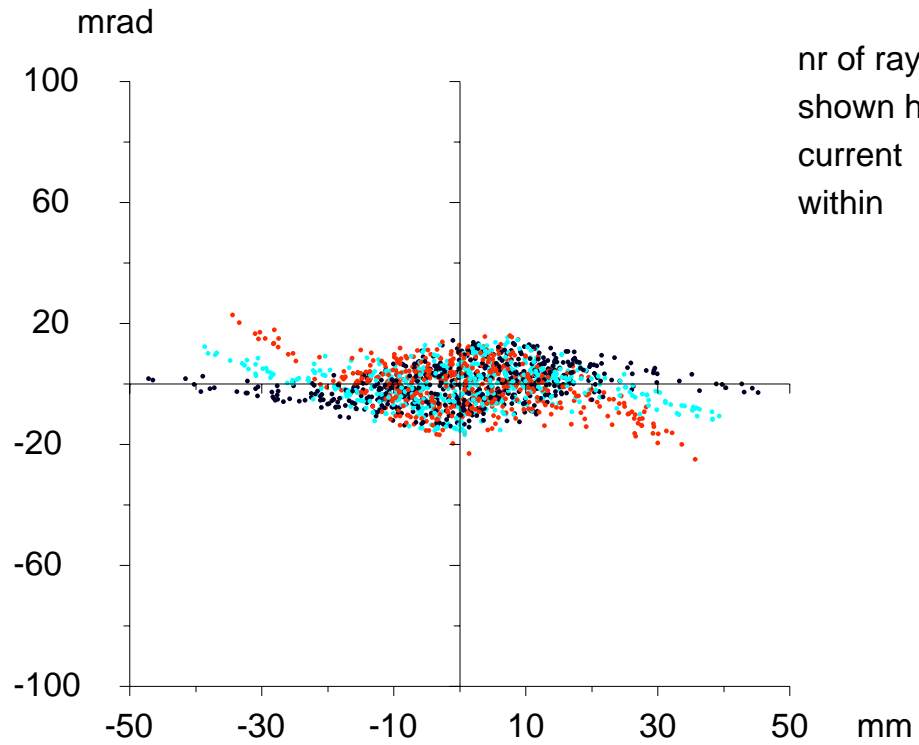



KOBRA3-INP



y emittance at 2.610 m

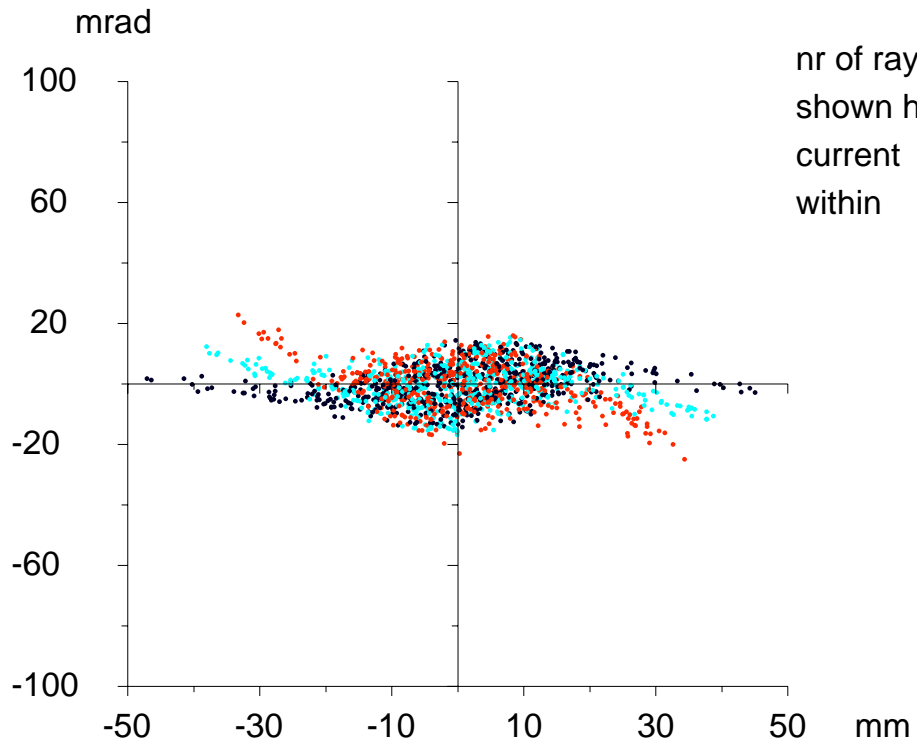



- Simulation confirms the experimental data:
- Strong influence of space charge within the extraction system and strong influence of space charge in the acceleration column.
- No influence of space charge has been observed in the drift sections and within the magnetic lenses.

Penning Ionization Gauge PIG

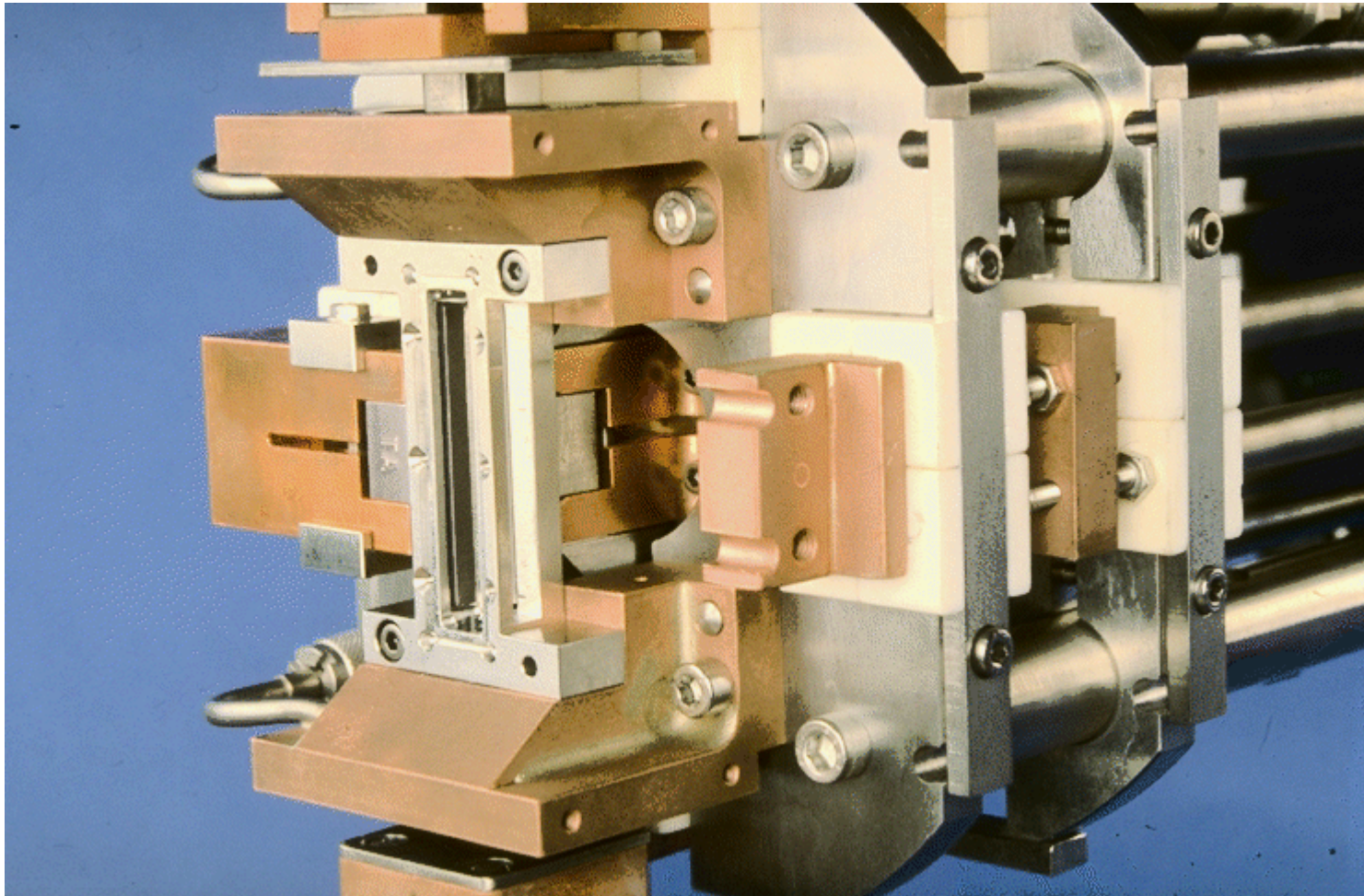

Penning Ionization Gauge PIG

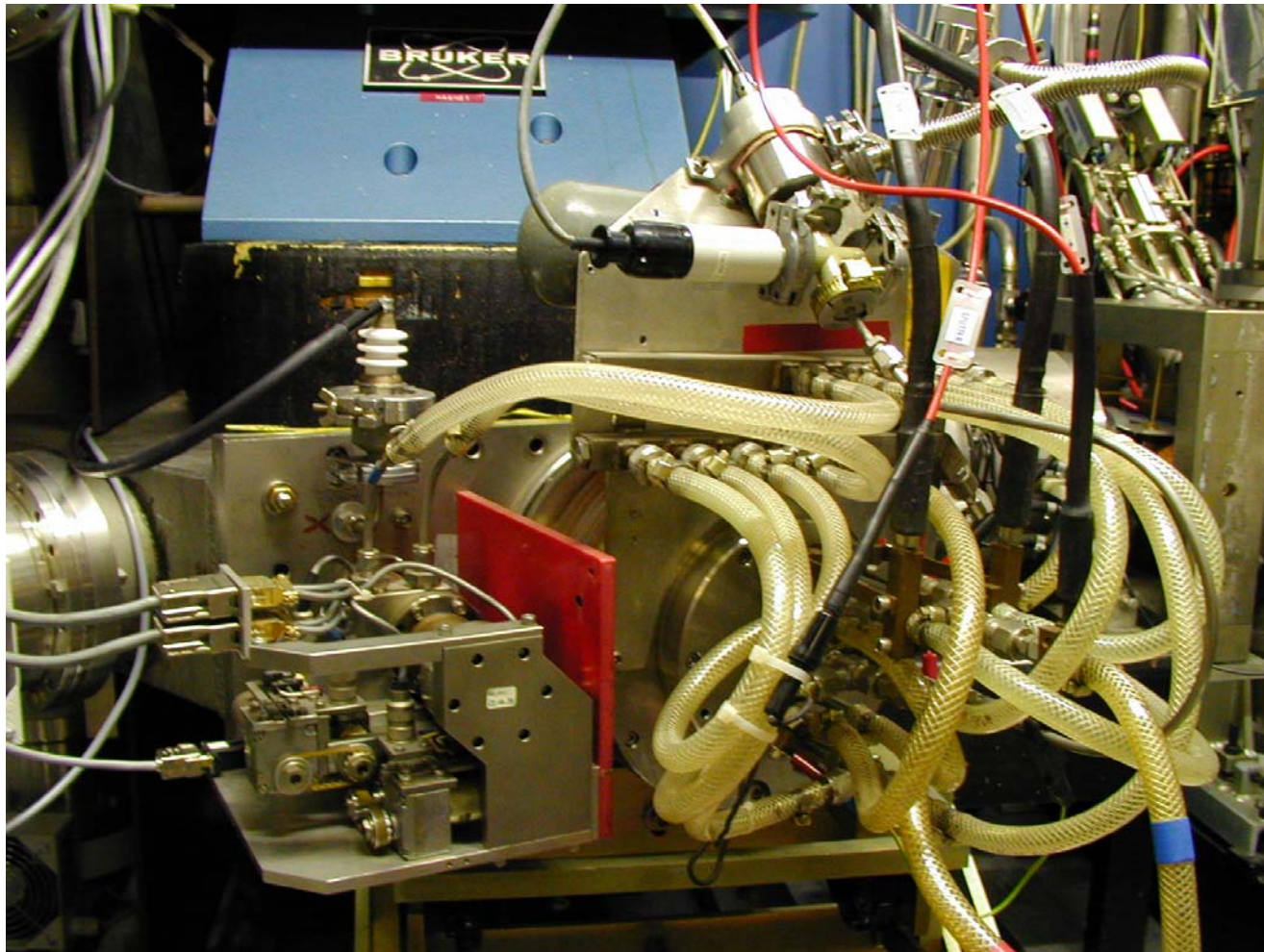

Penning Ionization Gauge PIG

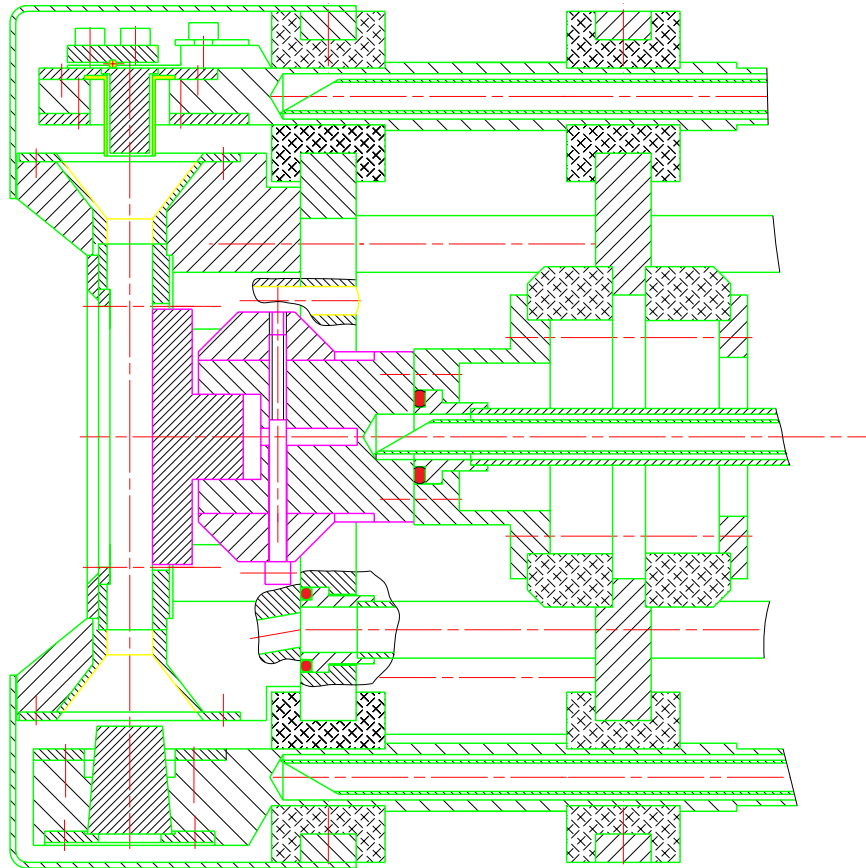

FRAME 1 APRIL 4, 2002 09.44.37

Penning Ionization Gauge (PIG)

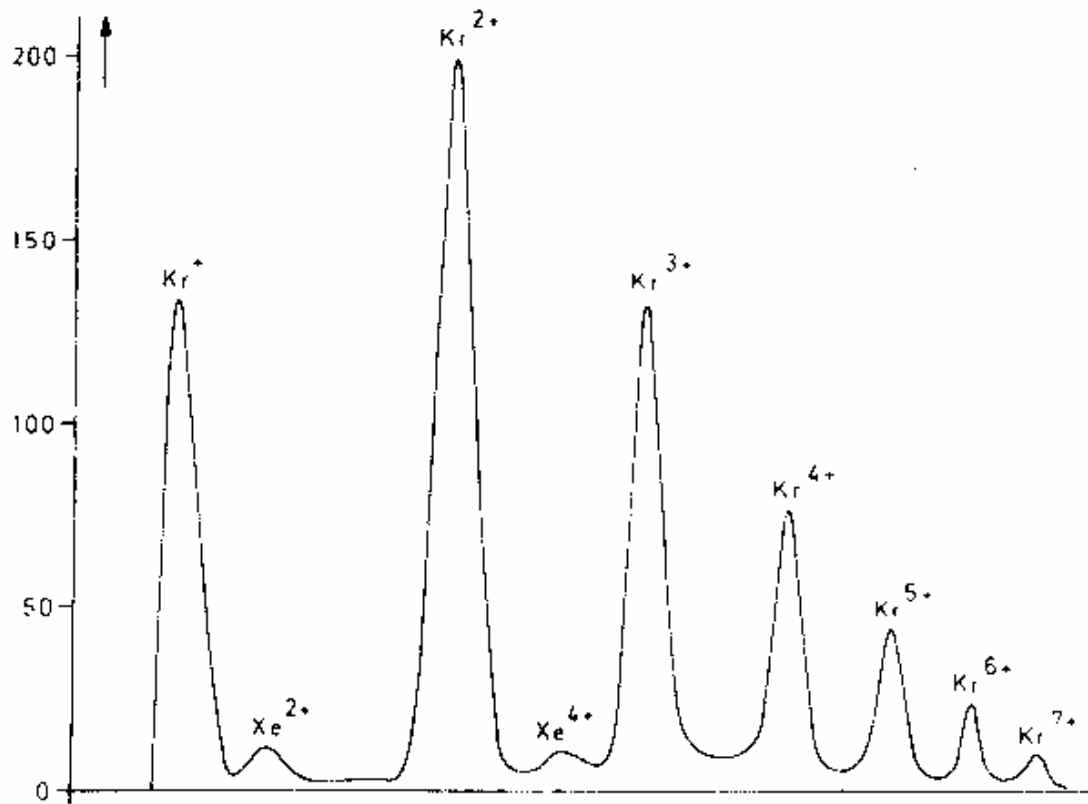

Krypton spectrum

mA/cm².

le or able

Penning Ionization Gauge PIG

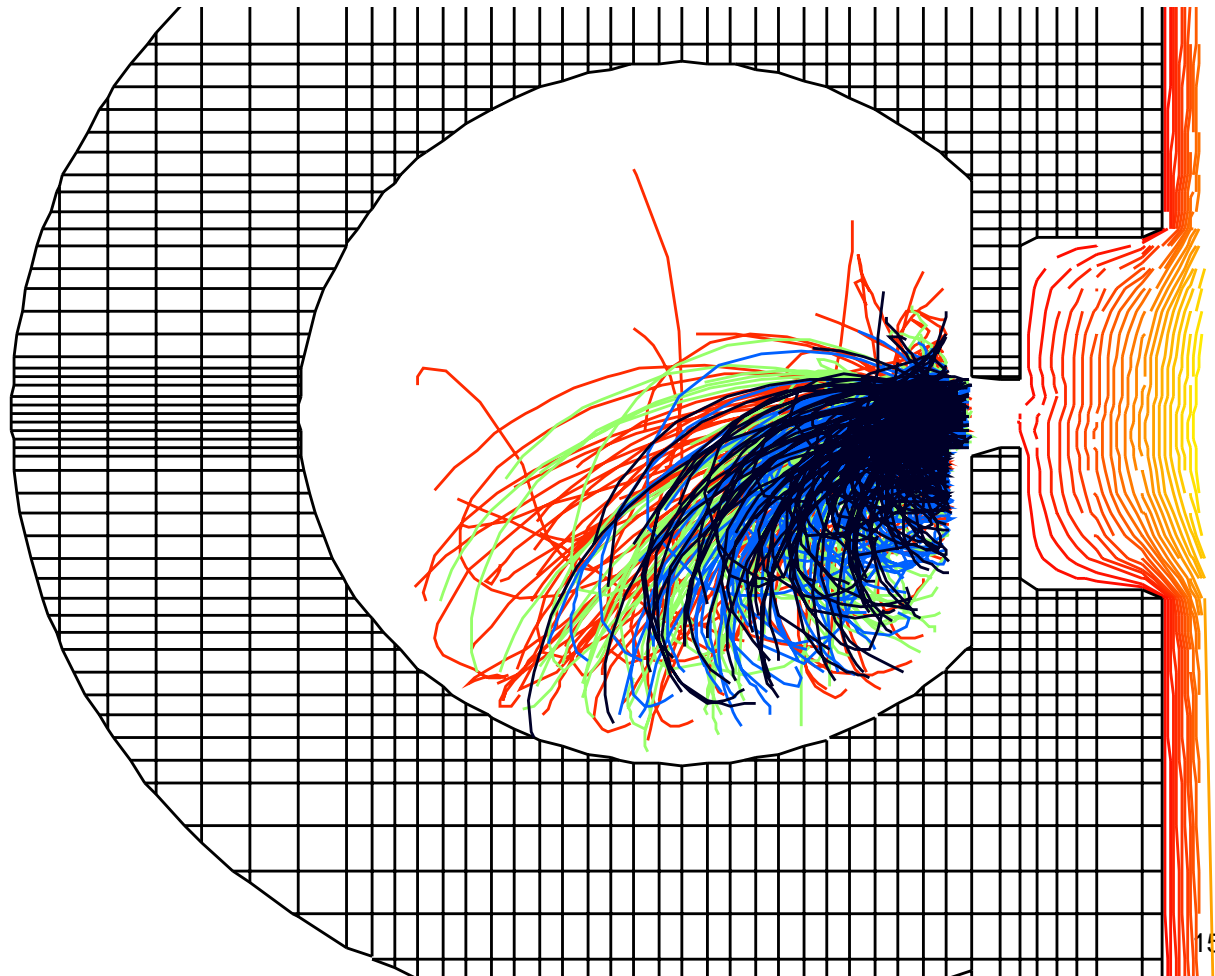

Penning Ionization Gauge (PIG)

y [mm]

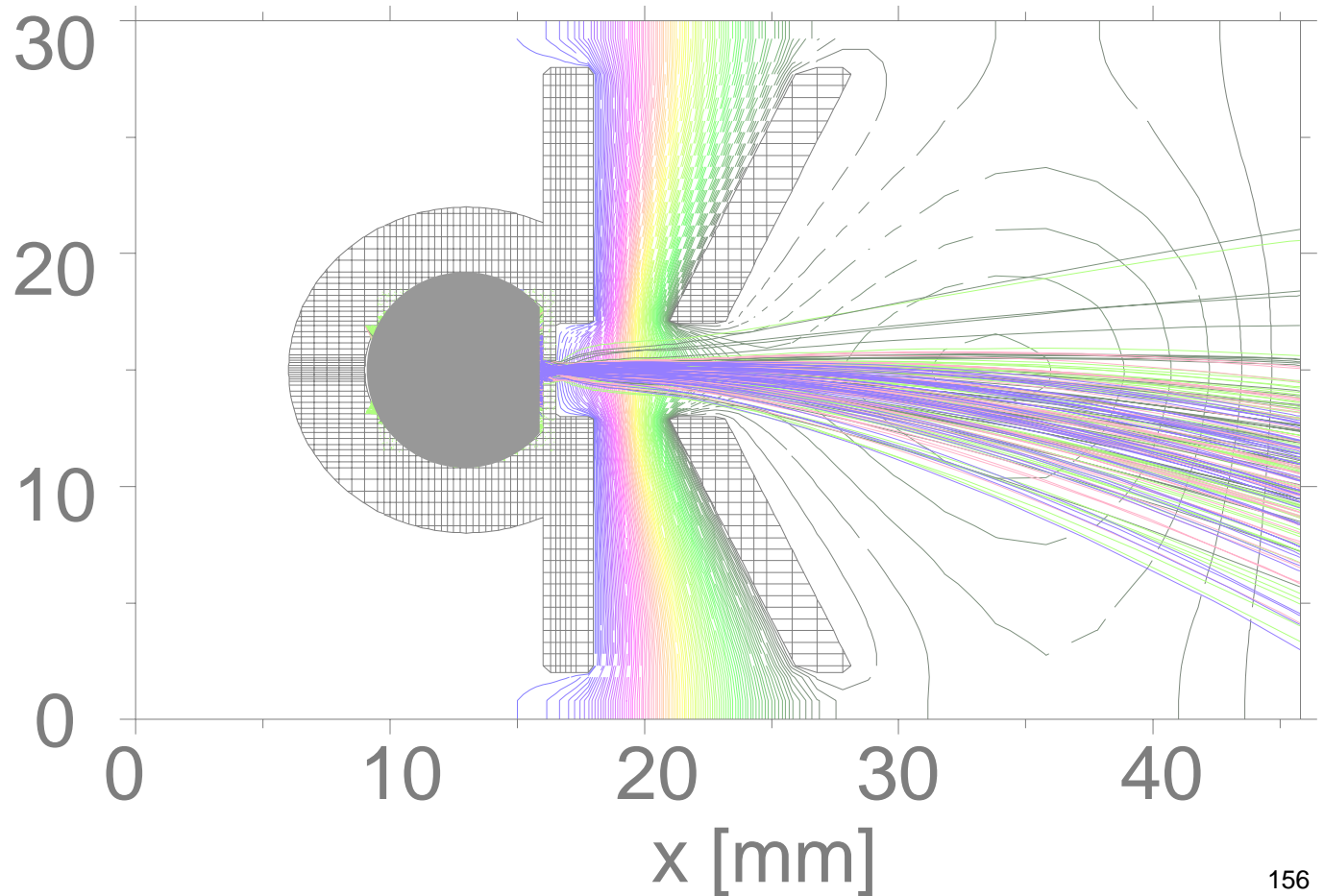

Penning Ionization Gauge PIG

y [mm]

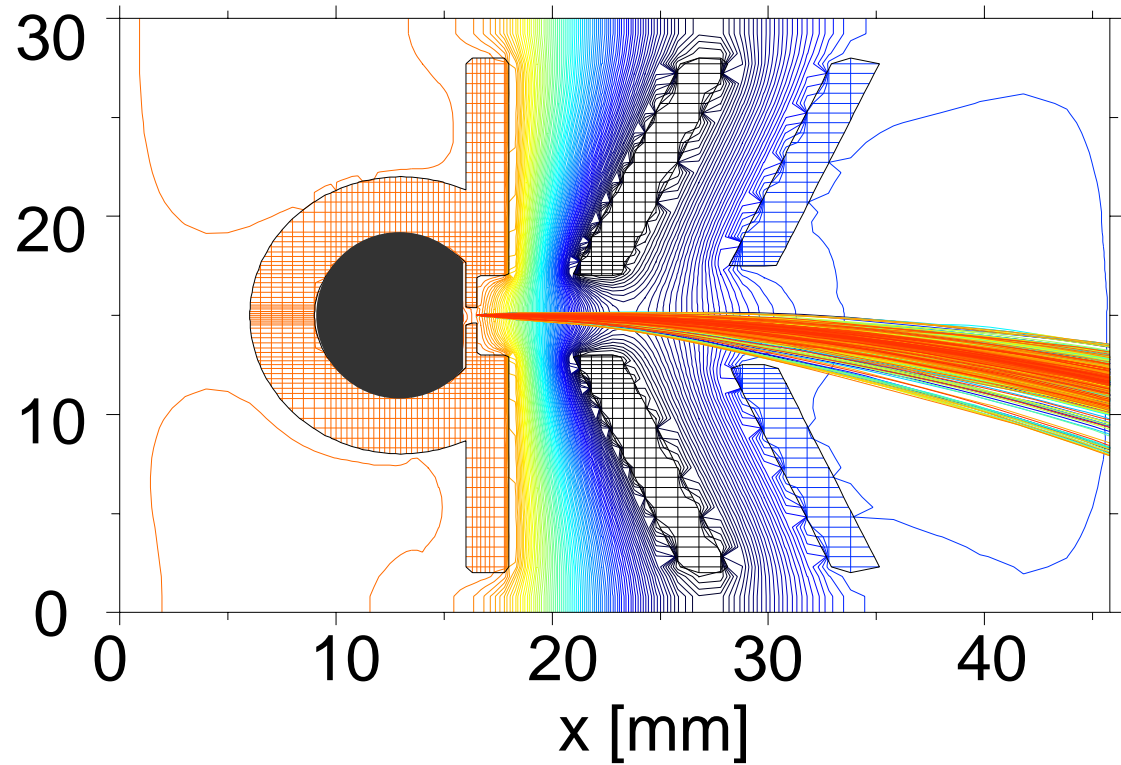

BEAM FORMATION

HSI high current injector at GSI

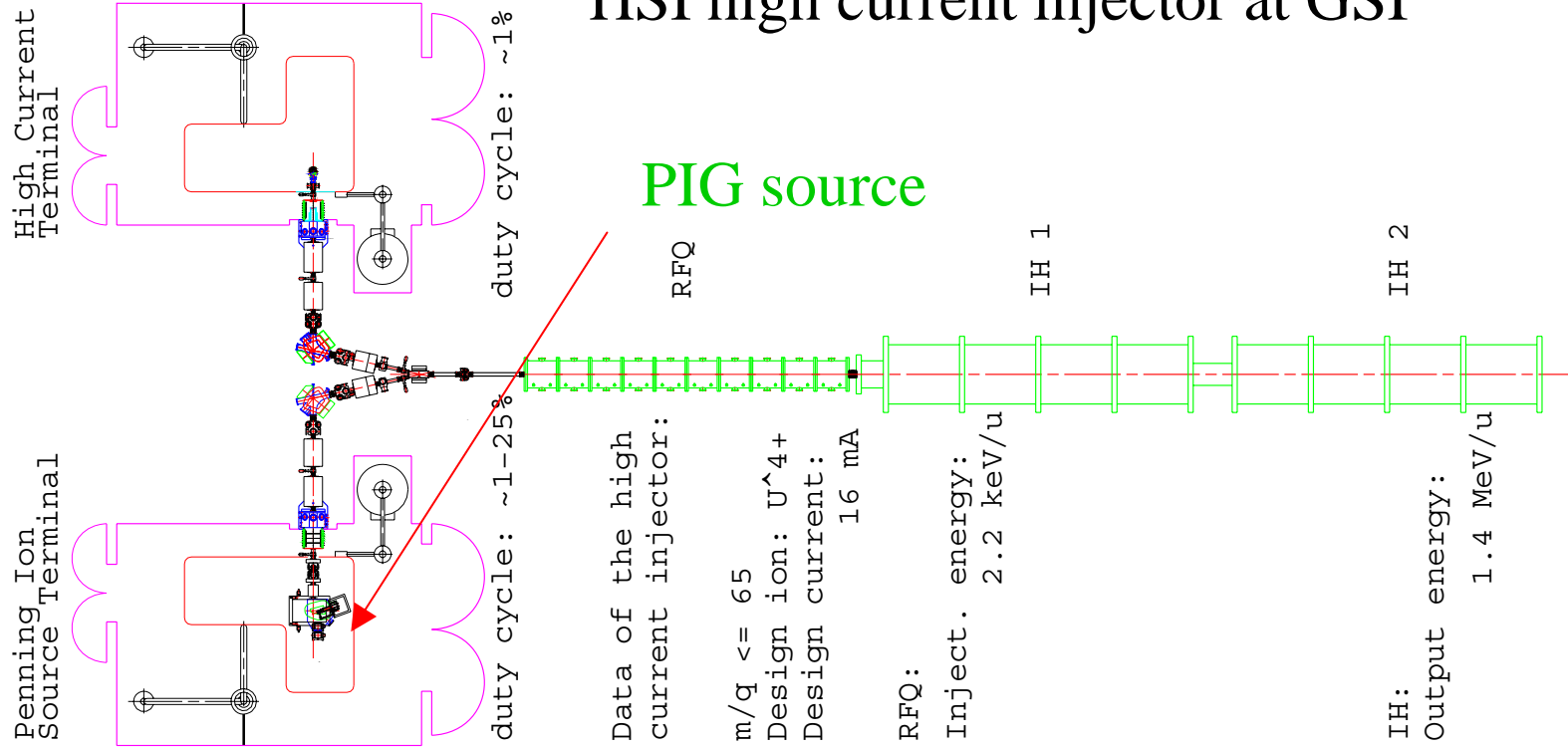

Penning Ionization Gauge PIG

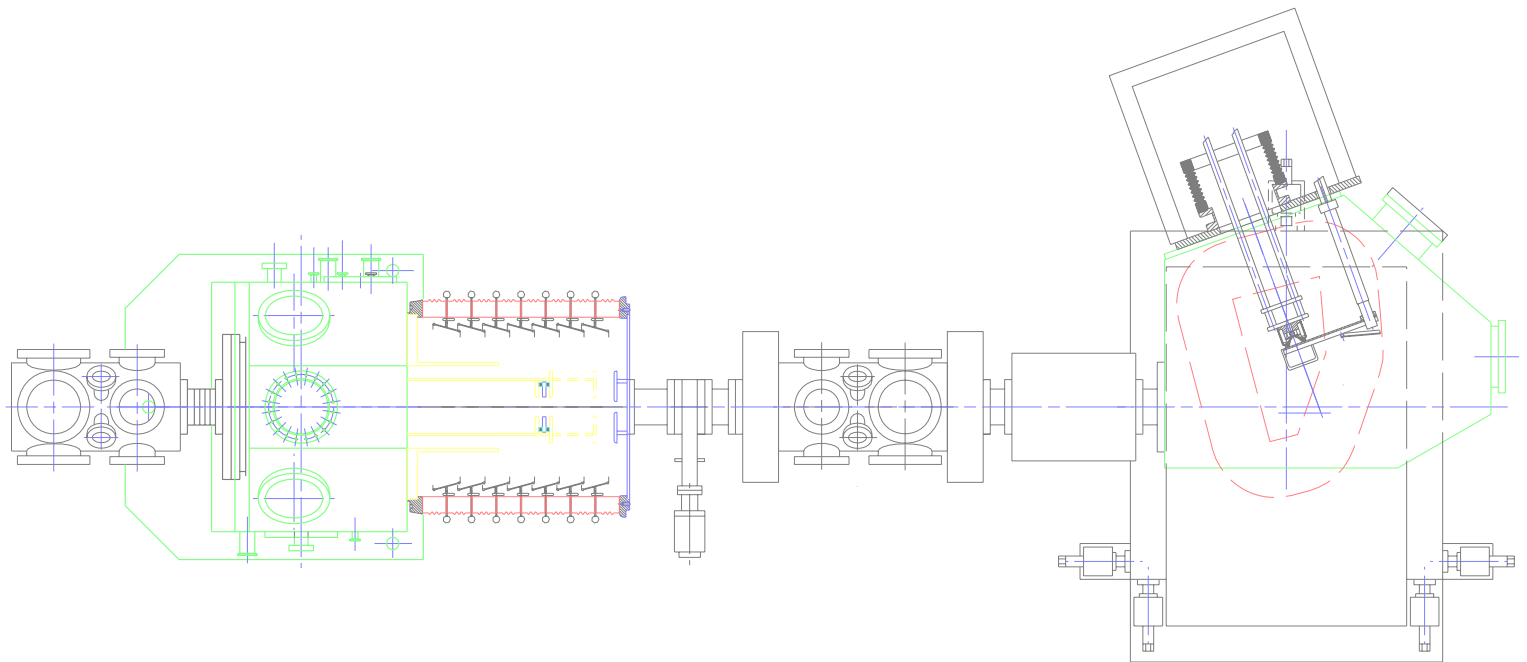

Penning Ionization Gauge PIG

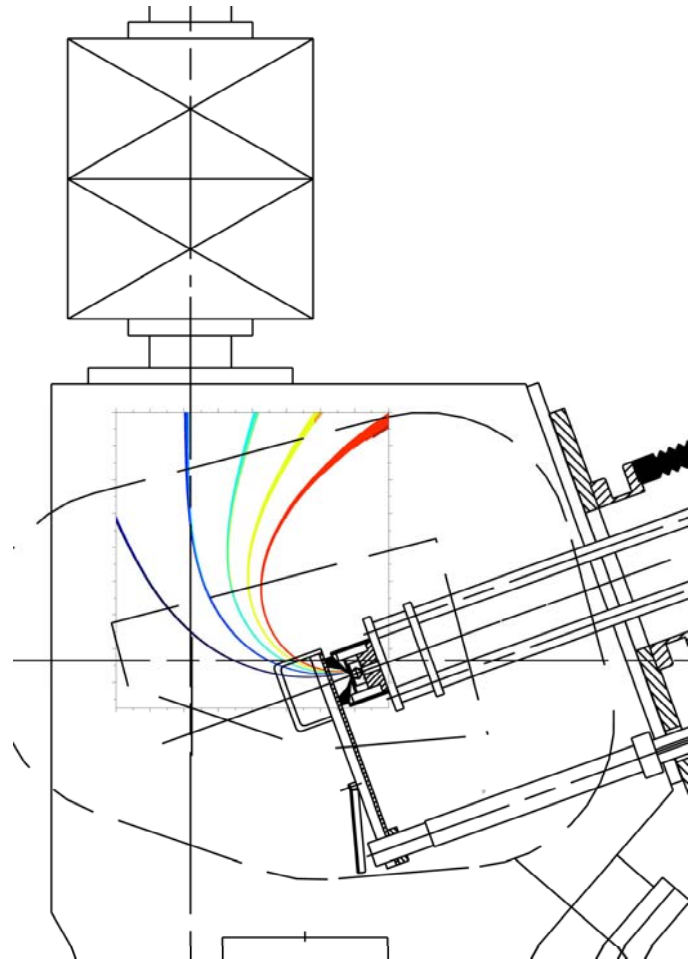

BEAM FORMATION

achieved ion currents from the PIG IS at the entrance of the RFQ with 2.2 keV/u

$^{12}\text{C}^+$	500	...	680	μA
$^{16}\text{O}^+$	700	...	890	μA
$^{18}\text{O}^{3+}$	1000	...	1100	μA
$^{20}\text{Ne}^+$	1000	...	4000	μA
$^{40}\text{Ar}^{2+}$	700	...	820	μA
$^{40}\text{Ca}^{3+}$	400	...	570	μA
$^{50}\text{Ti}^{2+}$	50	...	81	μA
$^{52}\text{Cr}^{3+}$	30	...	42	μA
$^{56}\text{Fe}^{4+}$	60	...	72	μA

$^{58}\text{Ni}^{3+}$	400	...	450	μA
$^{121}\text{Sb}^{7+}$	10	...	12	μA
$^{162}\text{Dy}^{7+}$	3	...	5	μA
$^{187}\text{Re}^{8+}$	100	...	165	μA
$^{197}\text{Au}^{8+}$	300	...	410	μA
$^{207}\text{Pb}^{9+}$	100	...	150	μA
$^{209}\text{Bi}^{9+}$	200	...	240	μA
$^{238}\text{U}^{10+}$	350	...	400	μA

Penning Ionization Gauge PIG

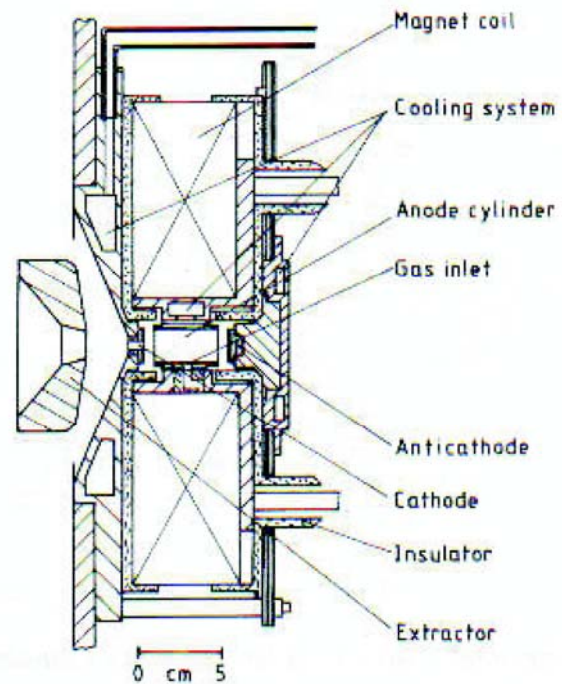

Penning Ionization Gauge PIG

KOBRA3-INP VERSION 3.39 potential plot RUN 2 10 0 11
xy plane 51 ,at z= .0182 meter iteration 9
*E -2 y [m] potential PLOT011.PS color table [V]

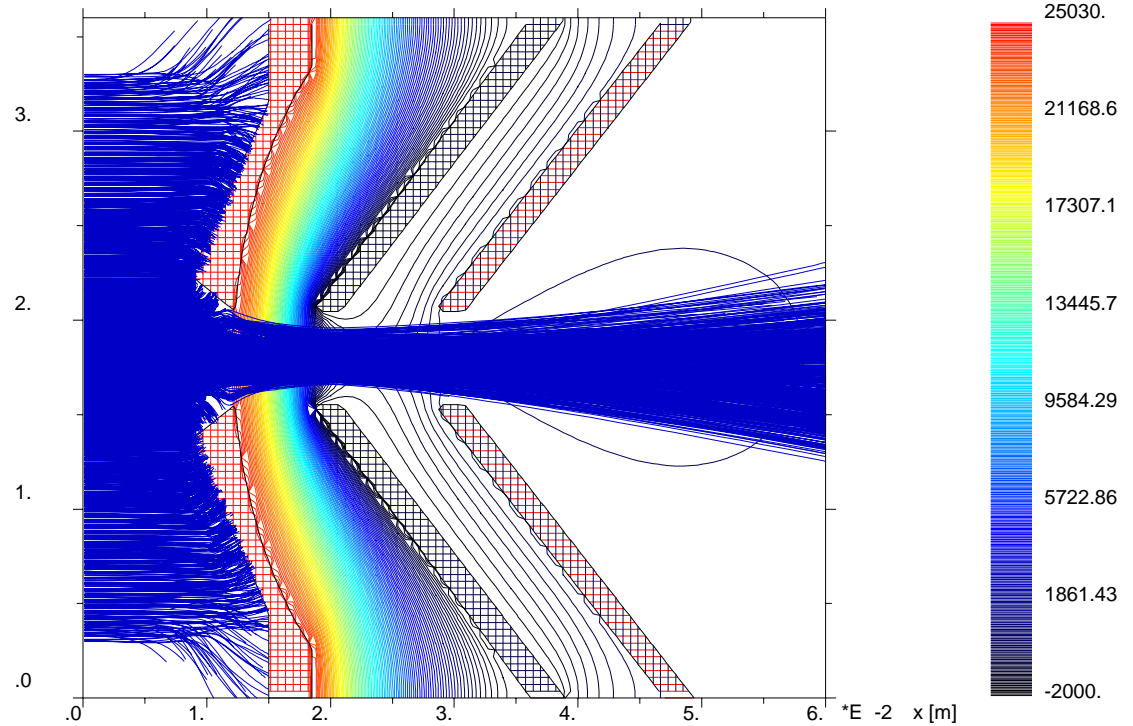

COMMENT: axial_pig_extraction

INP Wiesbaden (GERMANY)
DATE: 02/07/01 TIME: 07:36

Penning Ionization Gauge PIG

KOBRA3-INP VERSION 3.39
xy plane 51 ,at z= .0182 meter

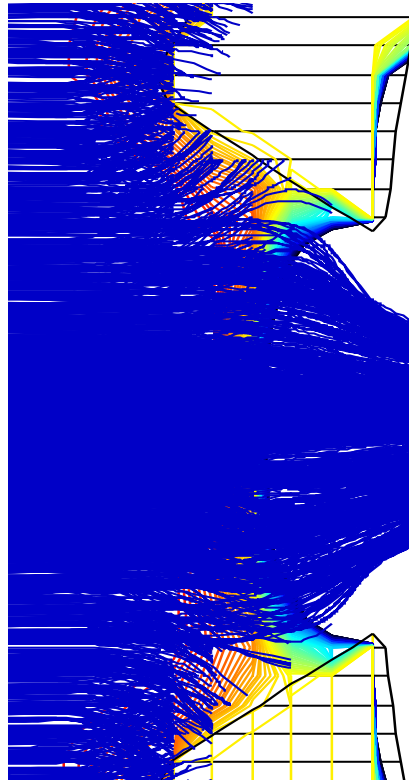

RUN 2 6 0 6
iteration 6
potential PLOT008.PS

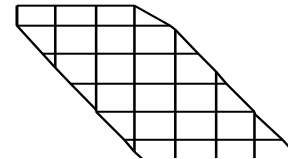
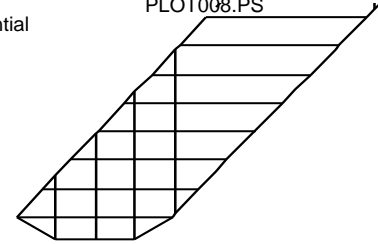

COMMENT: axial_pig_extraction

INP Wiesbaden (GERMANY)
DATE: 02/04/01 TIME: 21:21

Ion generators to come

- general
- mucis ion source
- mevva ion source
- Electron Cyclotron Resonance Ion Source ECRIS
- Laser Ion Source LIS
- Liquid Metal Ion Source LMIS
- Electron Beam Ion Source EBIS
- H^- source

