

To promote excellency in patient care and innovative proton treatment

Therapy Control and Patient Safety

Martin Grossmann

Centre for Proton Therapy, Paul Scherrer Institute, Villigen, Switzerland

Overview

- Protontherapy @ PSI
- Controls and Safety
 - Concept
 - Implementation
- Patient Safety System

Paul Scherrer Institute

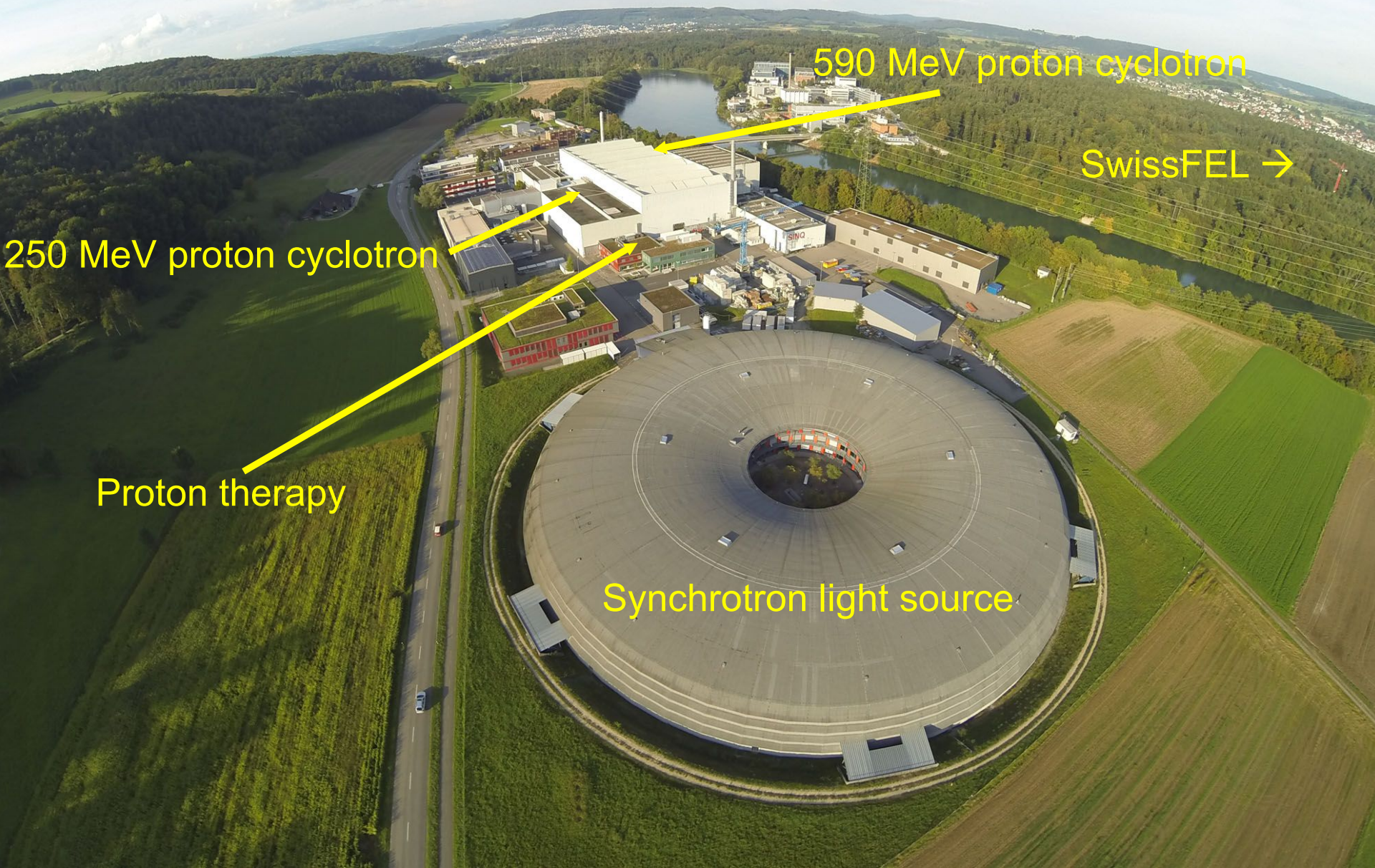

590 MeV proton cyclotron

SwissFEL →

250 MeV proton cyclotron

Proton therapy

Synchrotron light source

PROScan facility at PSI



COMET



Gantry 1

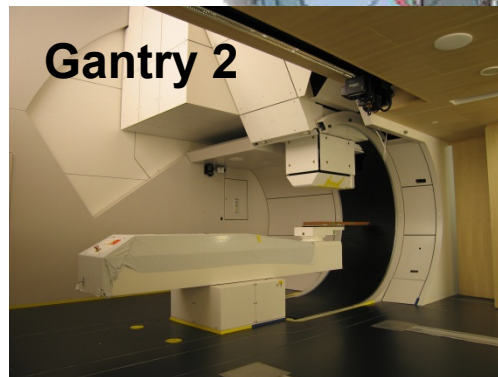
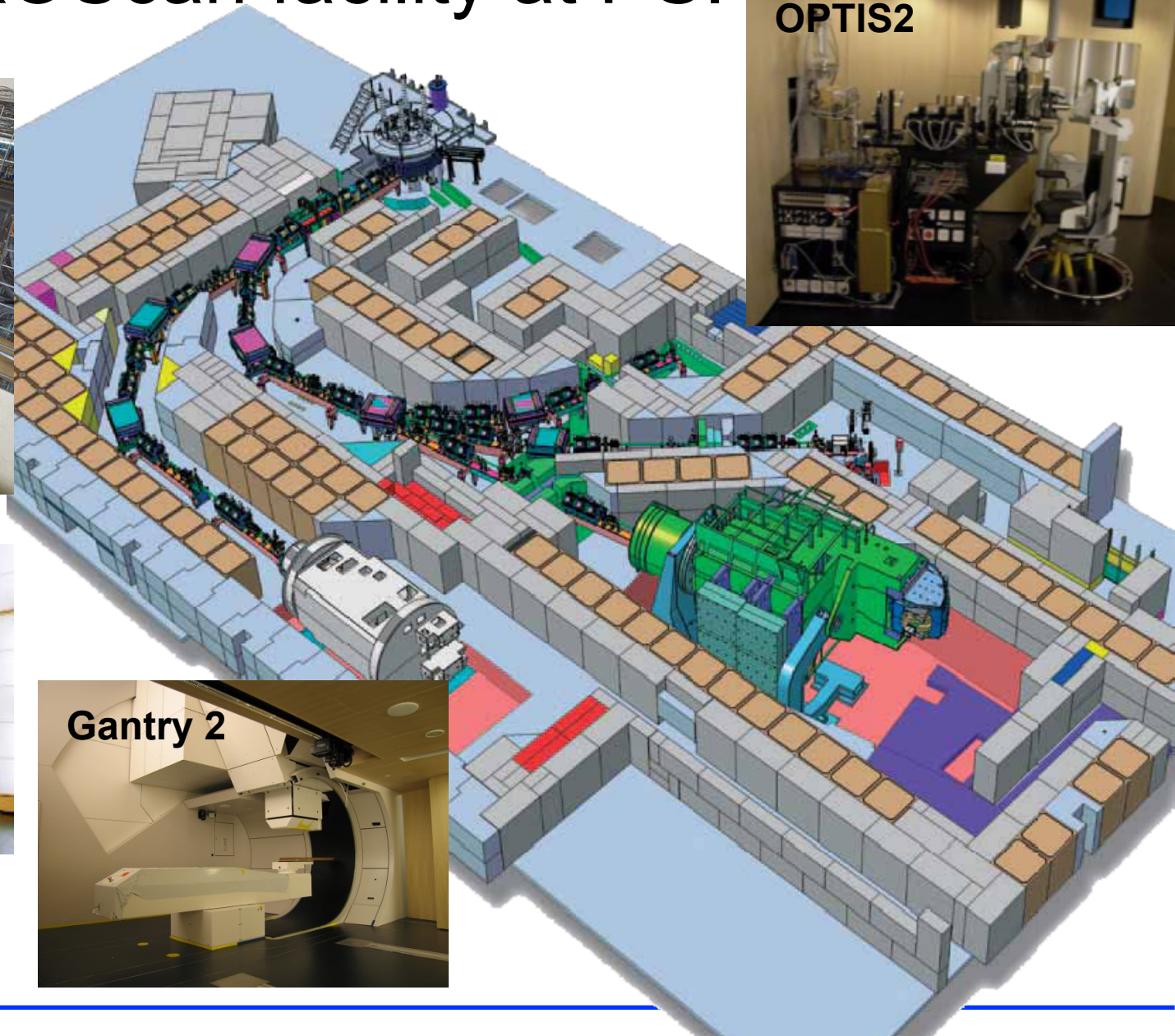

Gantry 2

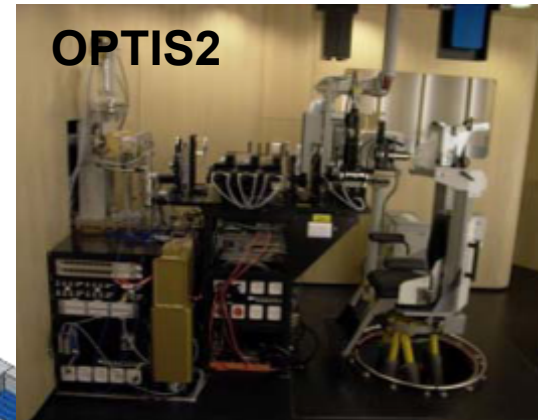

OPTIS2

Superconducting cyclotron with intensity modulation I

Cyclotron COMET
Varian/Accel
250 MeV protons
Deflector plate for
fast beam current
regulation $\sim 50 \mu\text{s}$

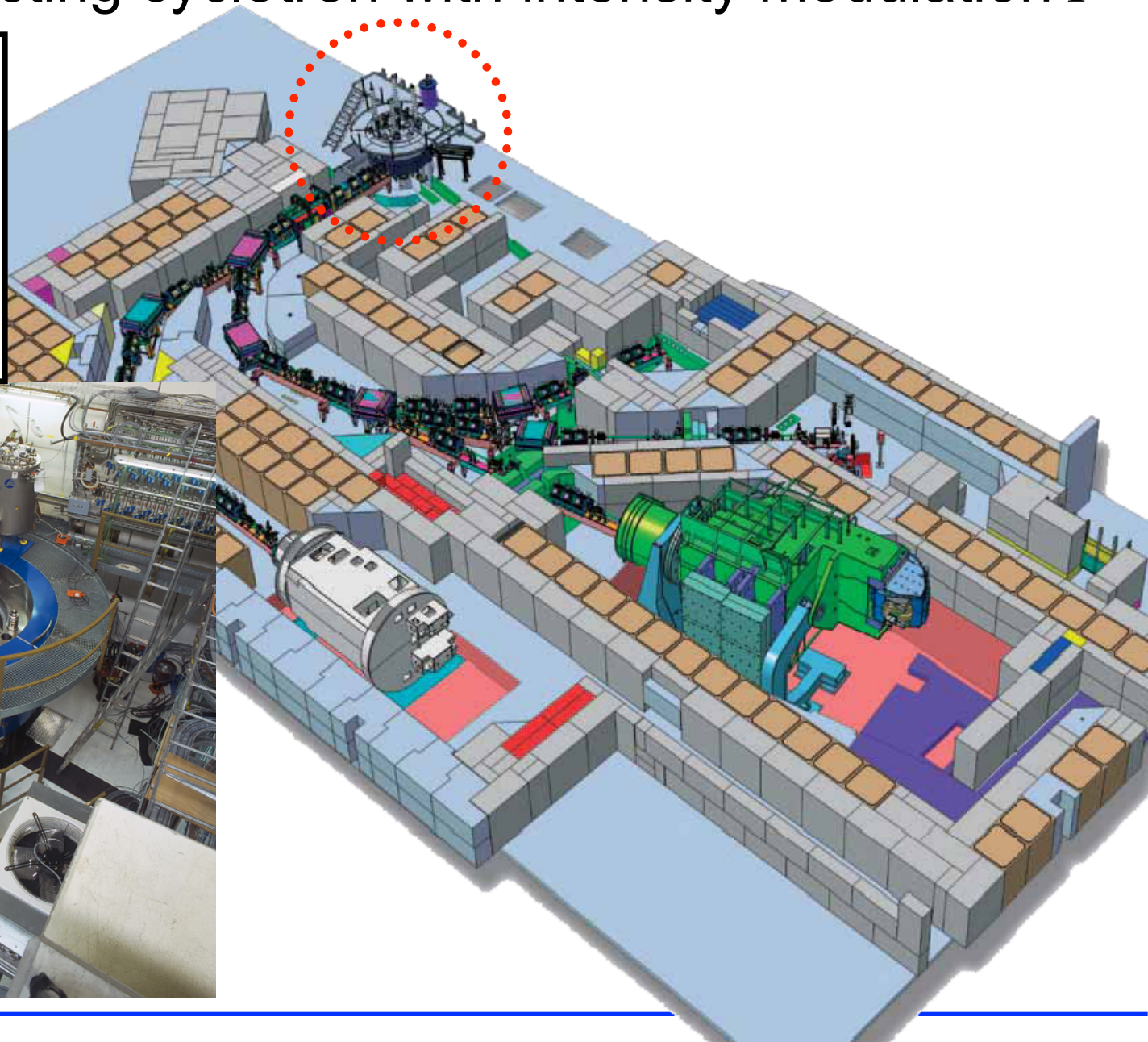
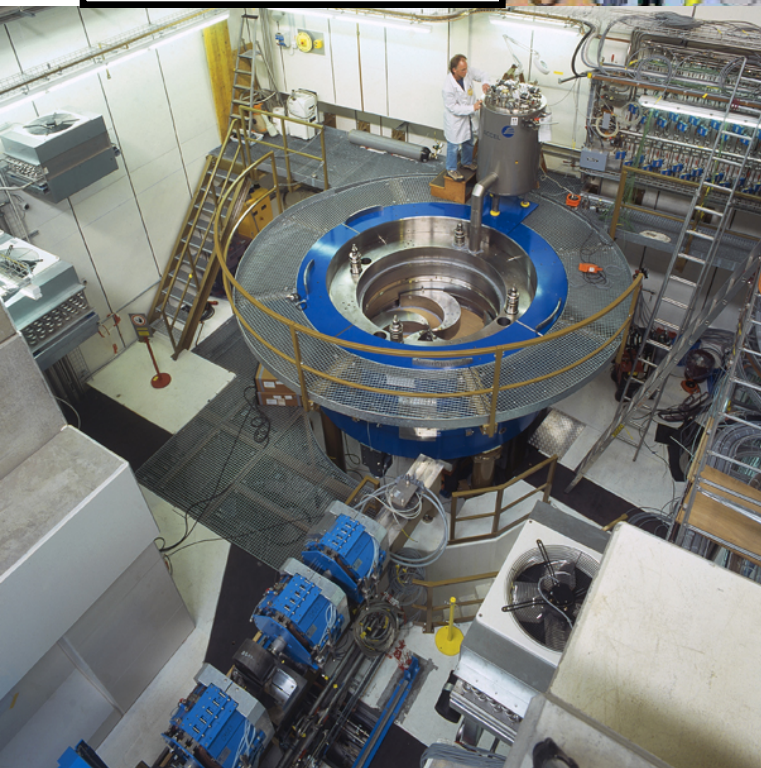

Degrader and beam line for energy selection E

Degrader (carbon wedges in vacuum) and laminated beam line for fast energy changes < 80 ms

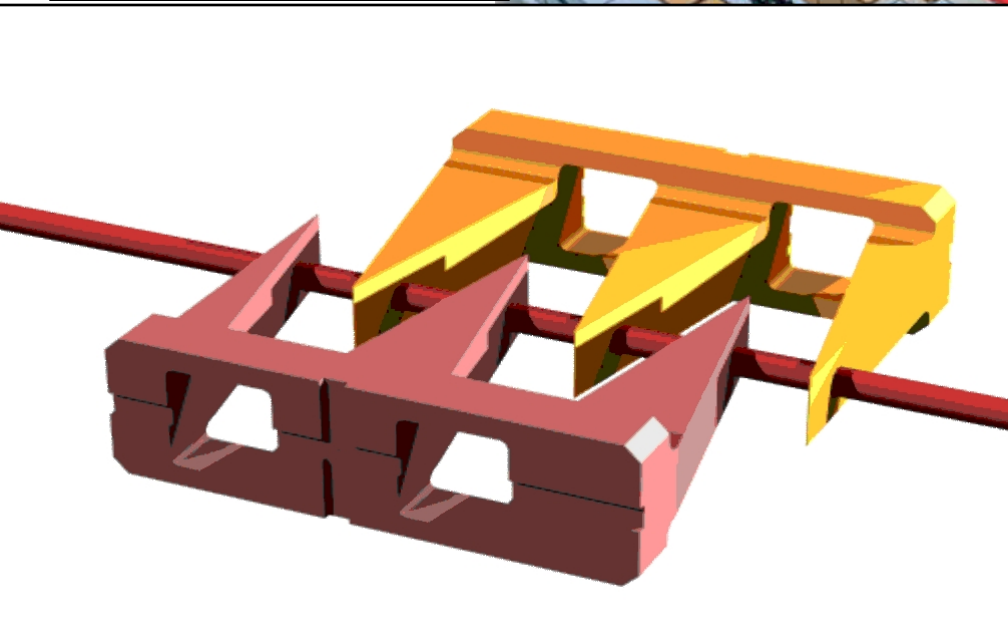
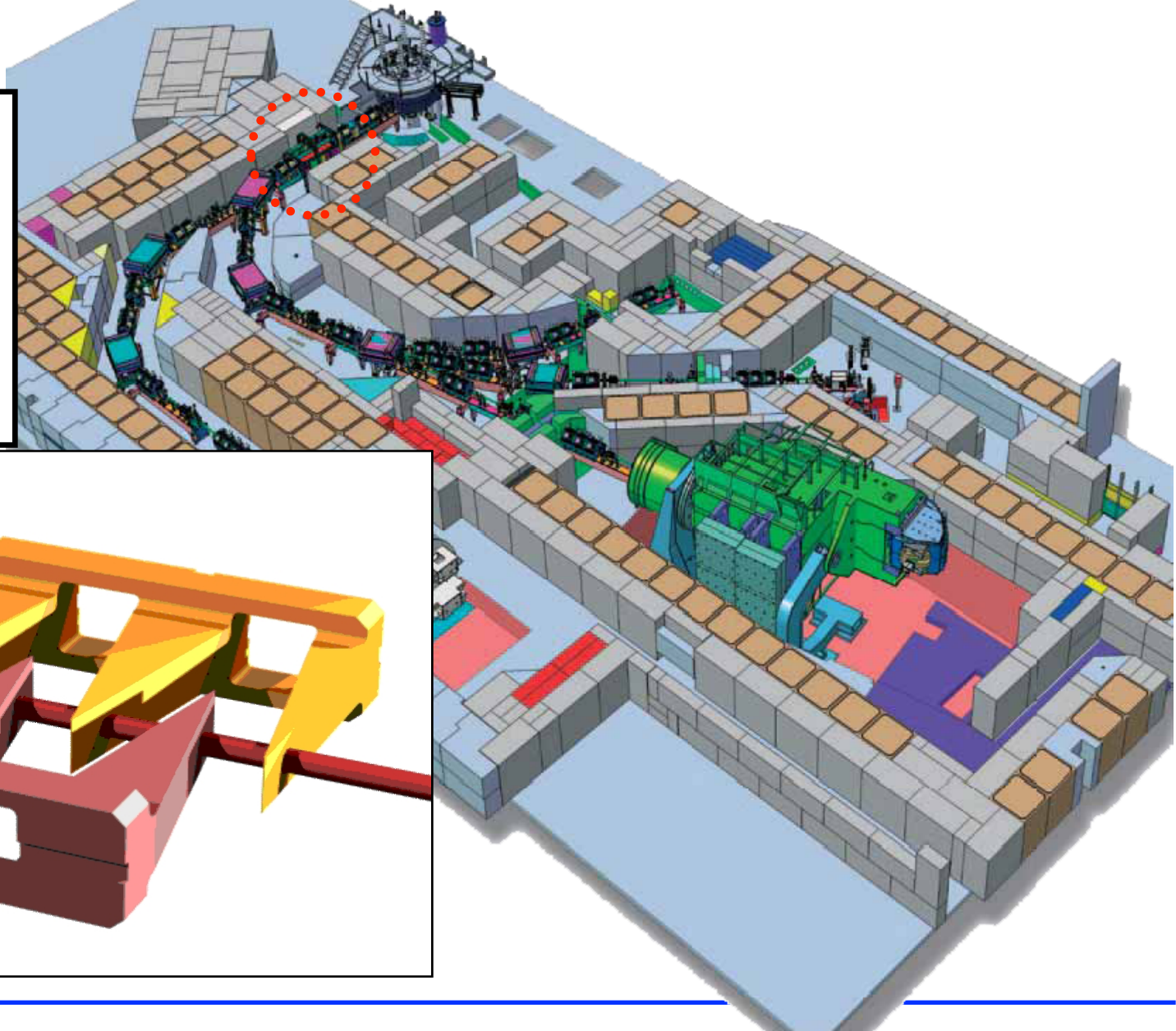

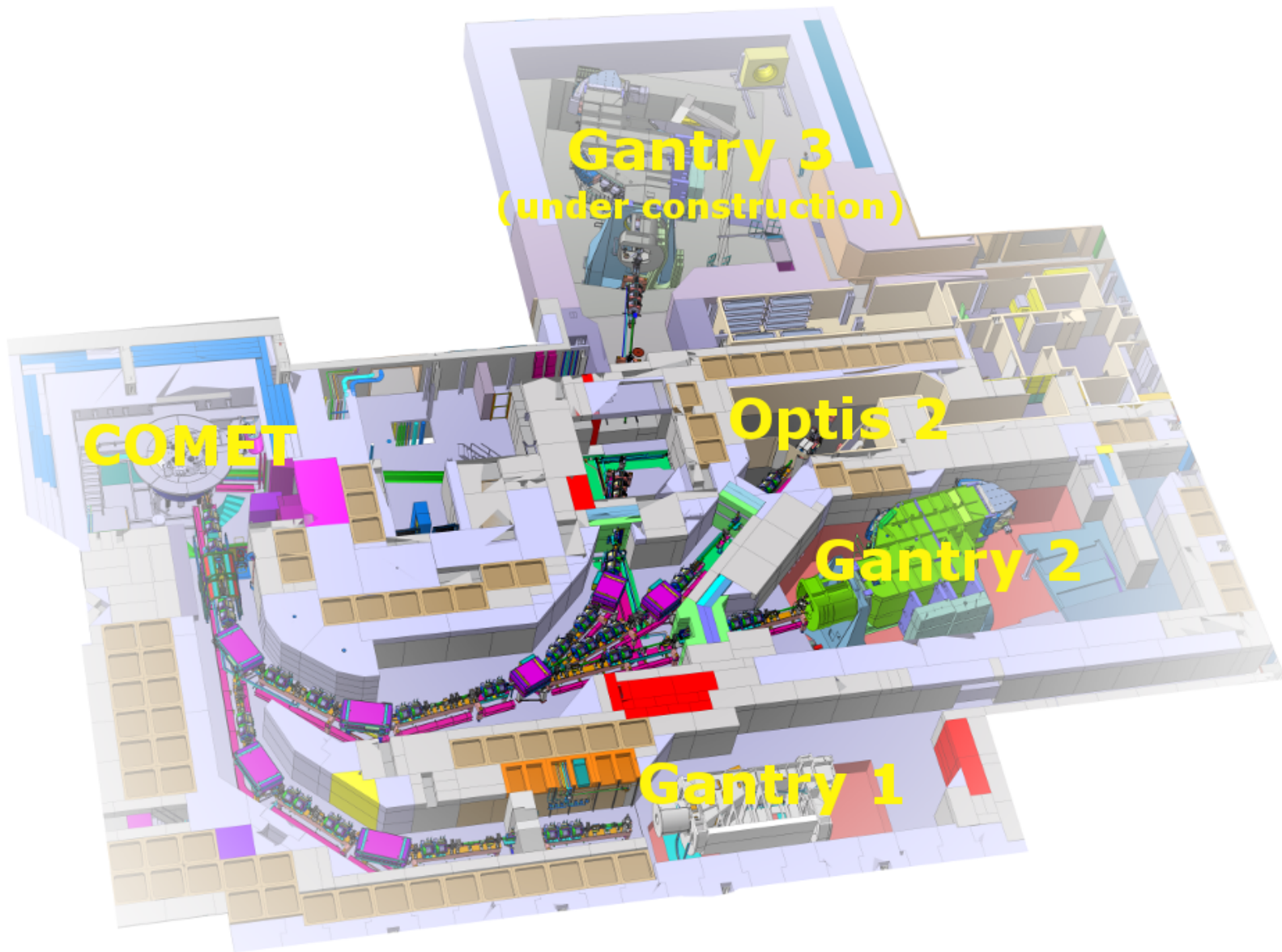

Controls & safety

PSI's concept for patient safety



PSI PAUL SCHERRER INSTITUT					
Titel	Report on Proton Therapy Safety Measures for Gantry 2	Registrierung	TM-17-13-01		
Autoren / Autorinnen	Christian Bula, Martin Grossmann, Stefan König, Tony Lomax, David Meer, Werner Roser, Martin Rejzek	Date	18.01.2013	Version	2.1
Summary <p>The general focus of this document is a safety assessment of the proton radiation hazards to a patient due to the proton therapy, and to ensure that the treatment is correctly delivered in the Gantry 2 area of the Center for Proton Therapy at the Paul Scherrer Institute.</p> <p>This report on safety measures, comprising one of several safety aspects as covered by the "Gantry 2 Sicherheitsbericht", follows the structure and principles of risk reduction as used in the reports of Gantry 1 and OPTIS2.</p> <p>Based on this report, with the realization of the measures, and with the quality assurance program in place, we consider the treatment with protons in the Gantry 2 area to be both safe and efficient.</p>					

- Definition of safety goals
- Description of technical/operational measures

#1: NO RADIATION ACCIDENT

- No serious overdose should be delivered to the patient
- Serious: $>5\%$ of total prescribed dose (60 Gy), i.e. 3 Gy

#2: NO ERROR IN THE DELIVERED DOSE

- No incorrect dose should be delivered
- Prevent errors (hot/cold spots) in dose distribution of $>2\%$ of planned field dose

#3: NO ERROR IN DOSE POSITION

- The dose must be applied at the correct position
- Prevent errors in a single spot delivery $> \pm 1\text{mm}$ in lateral direction and depth

#4: DELIVERED DOSE AND POSITION MUST BE KNOWN AT ALL TIMES

- If treatment is interrupted, the dose and position already applied must be known in order to allow correct continuation after interruption

Controls & Safety Concept

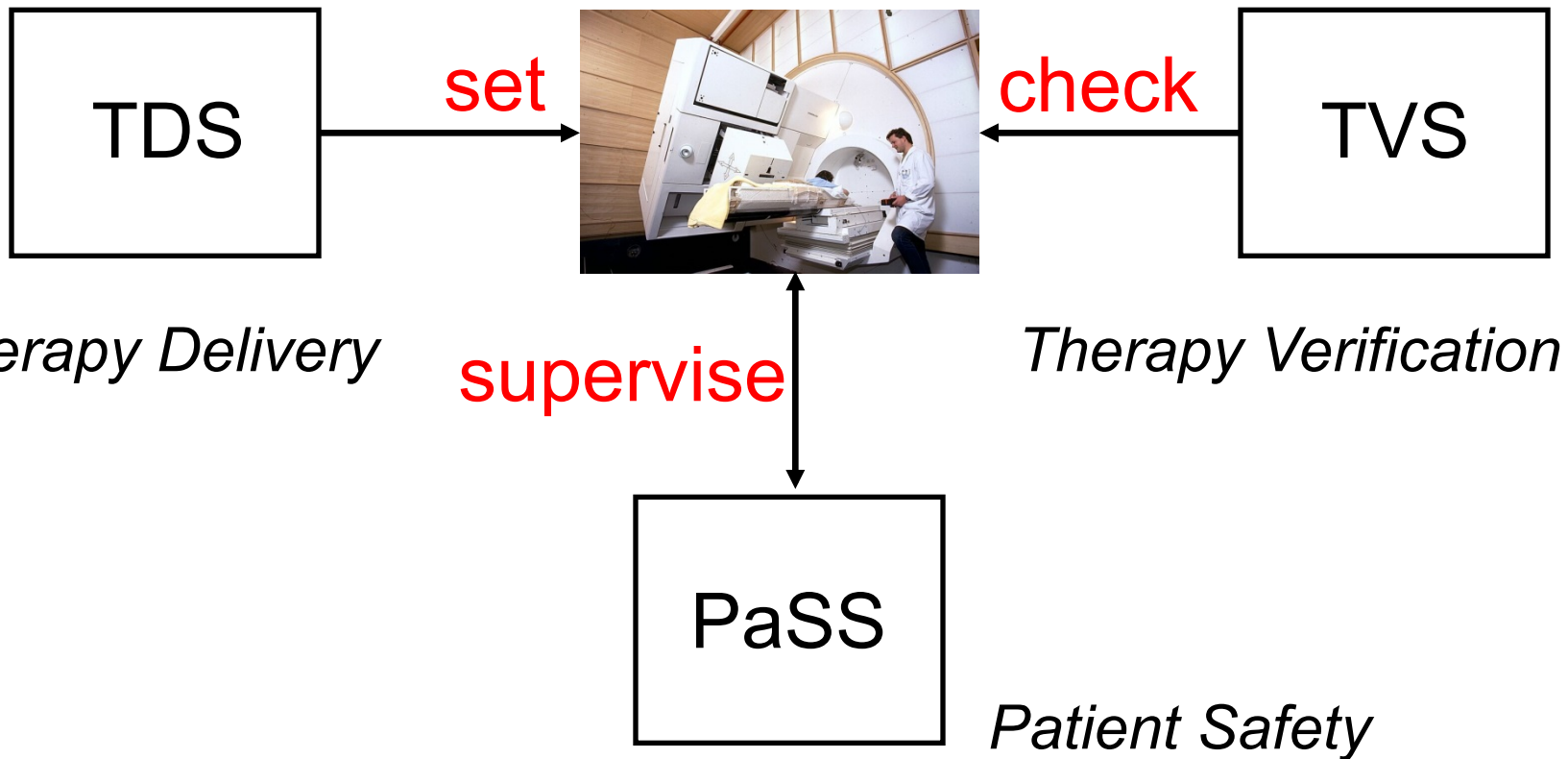

The Therapy Control System's Task

- The TCS
 - Controls the dose delivery
 - Is configured with the Therapy Plan generated by the Therapy Planning System
 - Controls and supervises the facility equipment to deliver the dose to the patient according to the plan
 - Generates a log of what it finally did with the patient

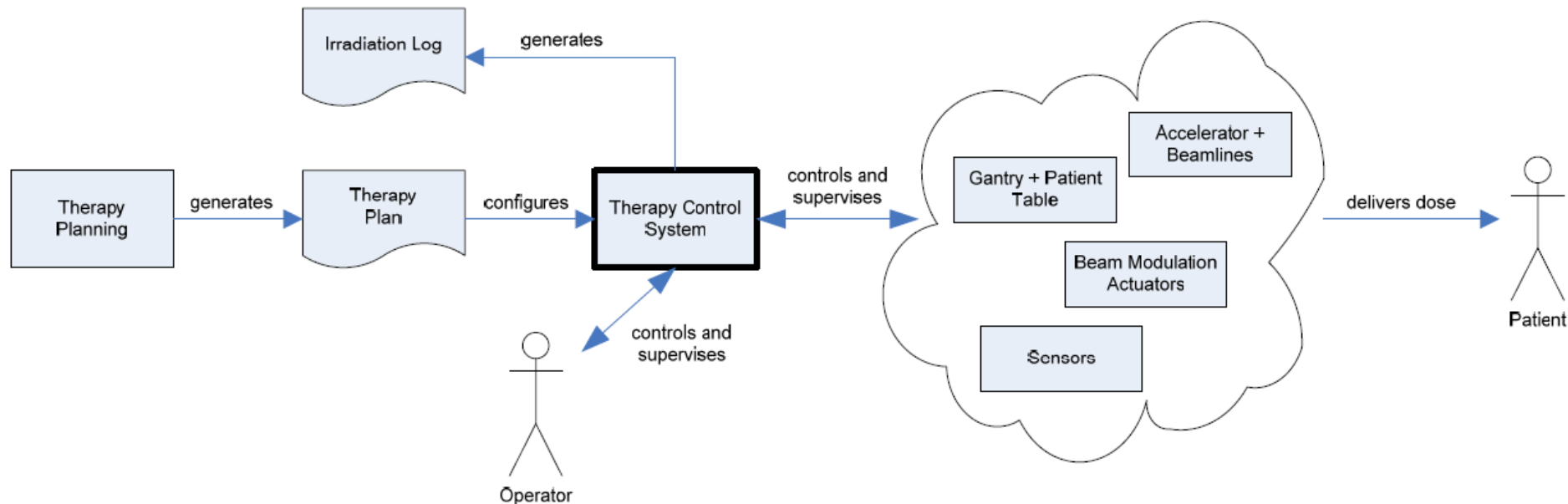

The Need for Speed...

- Minimize dead time between spots
 - PSI spot scanning: increase of dead-time by only 1 ms increases the total irradiation time by about 5 %...
- In safety relevant control system design, the speed requirement is normally put behind safety...

BUT

... A perfectly safe but slow scanning control system will be as useless as an unsafe fast one!

The Need for Speed...

- Our choices for the control systems:
 - The irradiation is controlled by embedded VME systems with Motorola PPC running the VxWorks RTOS
 - Subsystem communication with digital IOs, fast serial links (over optical fibres), reflective memories. Ethernet only when time does not matter
 - Time critical functions directly implemented in custom FPGA or DSP based subsystems
 - Linux PCs as operator workstations

The Need for Speed...

embedded VME Single Board Computer

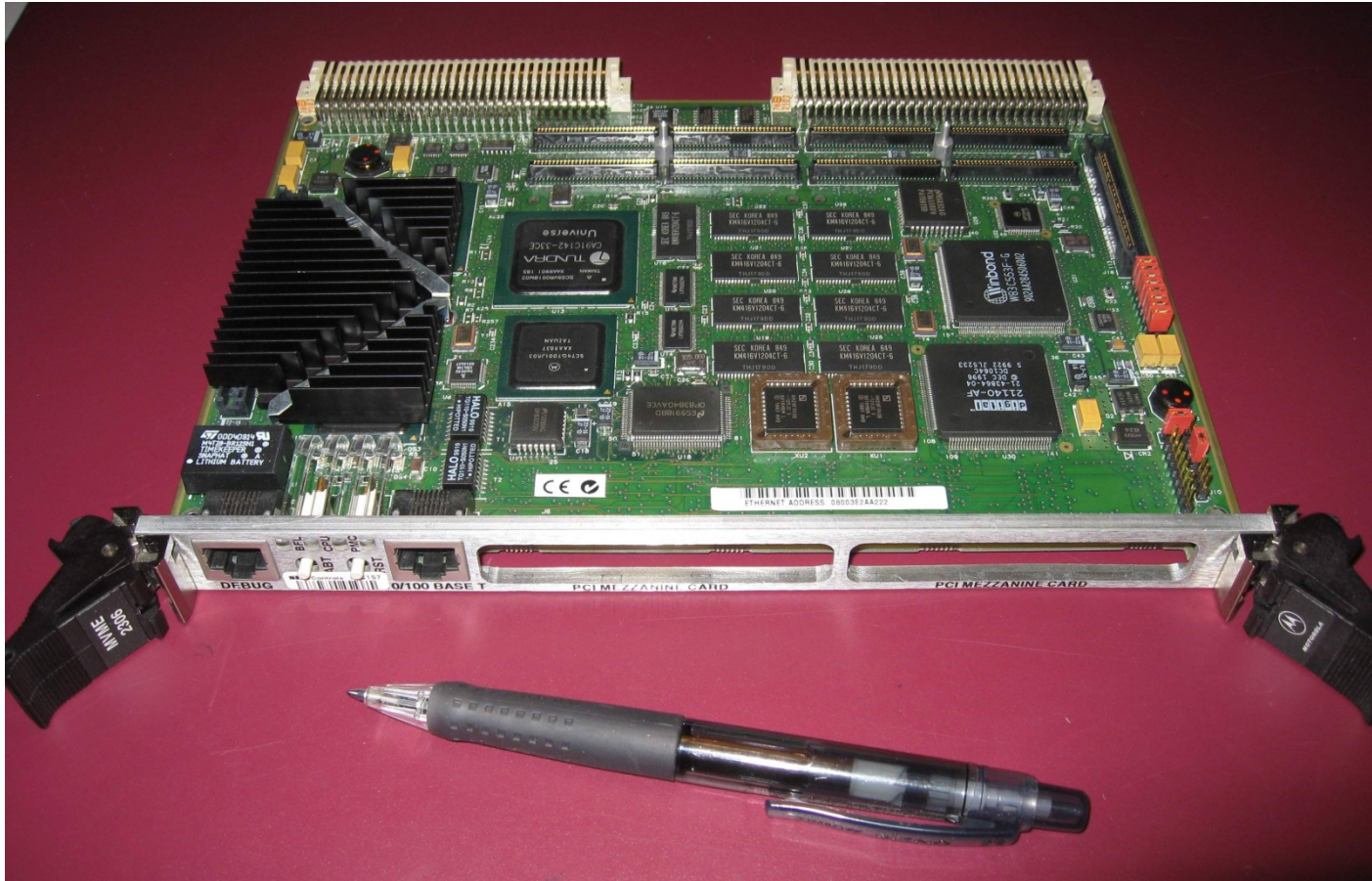

The Need for Speed...

VME crate (TVS)

with connections to sensors, actuators, ...

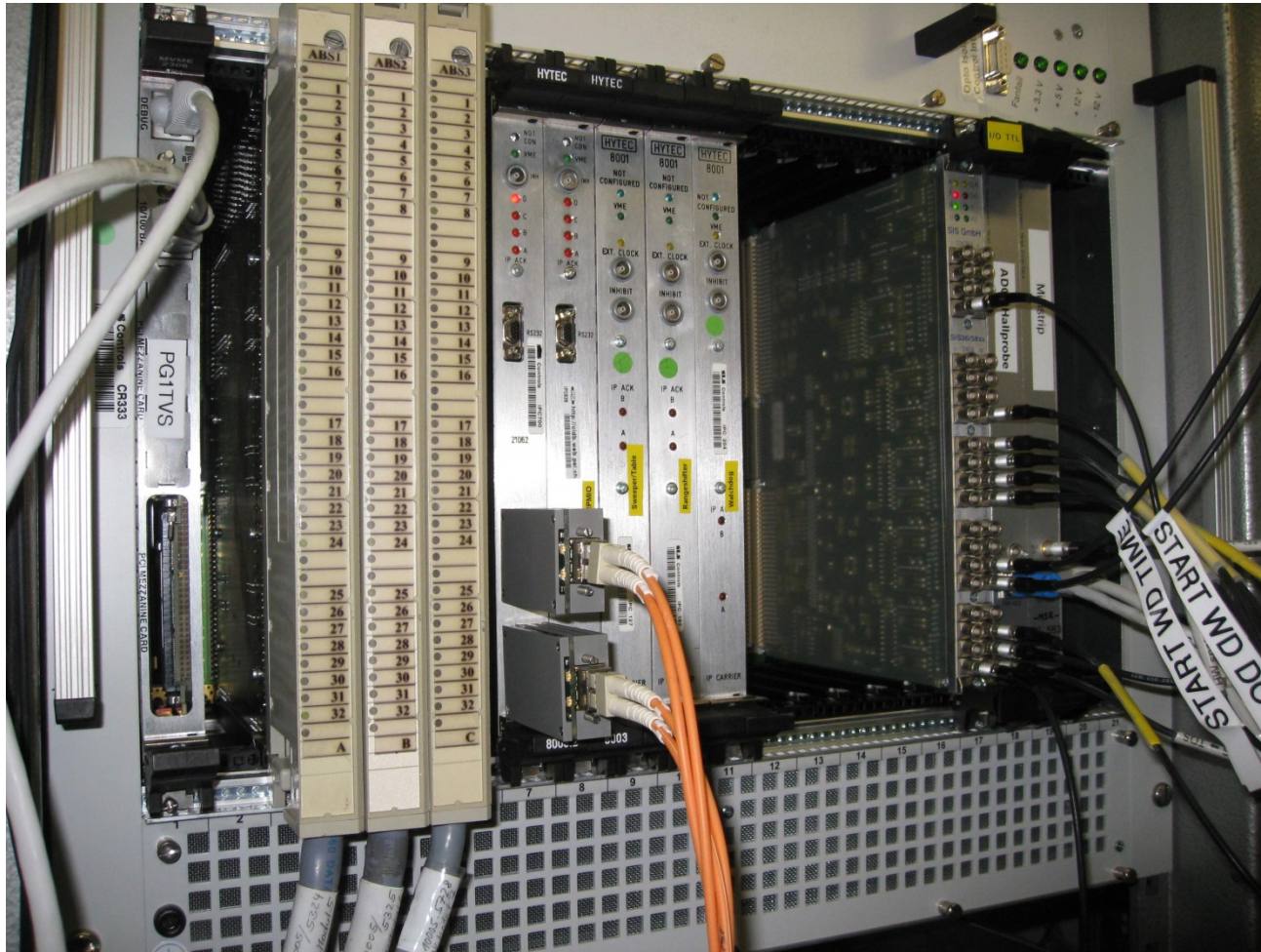

Graphical User Interface

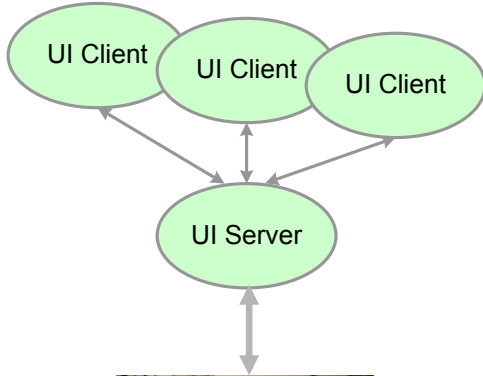

- client – server application
- implemented in Java

TCS G2GuiClient: Client1

TCS Interlock Gui Mode Ball Operations Utilities BTVS GPPS Info

Treatment Preparation

Patient ID:
 SF State:
 TDS Hash:
 TVS Hash:

Files instead PatBase

Select...
 Offsets...
 Clear Msg

Treatment Messages
 Changing to 'Files instead PatBase'=false

	Seq#	Type	Current	Status	#Elem	Applic.	Ball	Description
	1	AuxField	<input checked="" type="checkbox"/>	initial	1			CT to F1
	2	DoseField	<input type="checkbox"/>	initial	22		<input checked="" type="checkbox"/>	F1 - 1. dose field (alpha=0, beta=180, xPat=1, yPat=2, zPat=3)
	3	AuxField	<input type="checkbox"/>	initial	1			F1 to F2
	4	DoseField	<input type="checkbox"/>	initial	22		<input checked="" type="checkbox"/>	F2 - 2. dose field (alpha=5, beta=190, xPat=2, yPat=3, zPat=4)
	5	AuxField	<input type="checkbox"/>	initial	1			F2 to F3
	6	DoseField	<input type="checkbox"/>	initial	22		<input checked="" type="checkbox"/>	F3 - 3. dose field (alpha=10, beta=200, xPat=3, yPat=4, zPat=5)
	7	AuxField	<input type="checkbox"/>	initial	1			F3 to CT
	8	AuxField	<input type="checkbox"/>	initial	1			exceptional move from F1 to CT
	9	AuxField	<input type="checkbox"/>	initial	1			exceptional move from CT to F2
	10	AuxField	<input type="checkbox"/>	initial	1			exceptional move from F2 to CT
	11	AuxField	<input type="checkbox"/>	initial	1			exceptional move from CT to F3

started fractionLoaded fieldPrepared fieldInProgress

to StartPos... Prepare Apply Resume

STOP Unload Show Reports...

Reset ILKs Ack. GPPS

Has Interlocks: **false**
 Has GPPS Errors: **false**

/asm/home/g2sim/Patients/P99999/Plans/P99999.ready.steerTds

GuiServer: pc8574.psi.ch:55602 ● connected
 TDS: pioc01 ● connected
 TVS: pioc17 ● connected

fractionLoaded ● TDS executing Request
fractionLoaded ● TVS executing Request

LDAP User: mayor

Comet: 15.0 nA Area: 0.0 nA 2013-05-07 10:01:49

10:00:07 Could not find a Help Text for class 'ch.psi.proscan.foundation.gui.FoundationDialog' and tag 'Foundation.WindowLayout.SaveDialog'.



Spot Scanning Control Loop

- TDS & TVS walk through therapy plan:
 - TDS sets devices, TVS checks devices
 - when all devices ready: beam on!
 - spot termination by dose counter firmware
 - check correct application after each spot
 - write logs
 - proceed to next spot

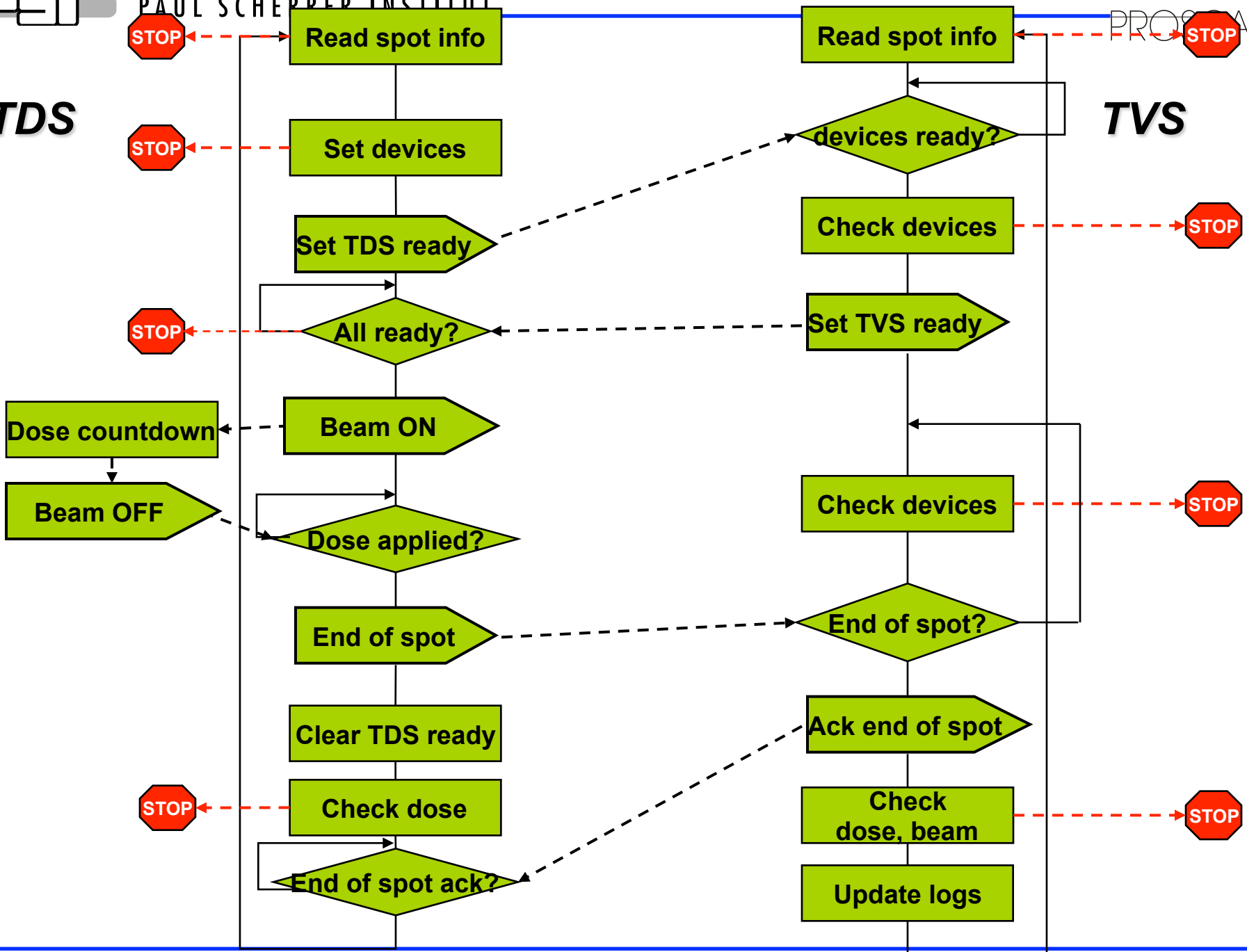
TDS
TVS

Spot Scanning: Operator Tools

Spot 2035 / P08464_CT0_T0_F0_D45.SCO / WED JAN 07 14:21:18 2009

Check ID	time [s]	IST	SOLL	TOL	difference	result	
SYNC	0.000	2: subset ready					
Sweeper	0.000	-2339	-2312	300	-27 -9 %	OK	
ADG3	0.000	6971	6967	348	4 1 %	OK	
RangeShifter	0.000	24	24	0	0	OK	
X	0.002	-41497	-41500	1000	3 0 %	OK	
Y	0.002	-112425	-112499	1000	74 7 %	OK	
Z	0.002	692562	692799	1000	-237 -24 %	OK	
A	0.002	-89984	-90000	500	16 3 %	OK	
B	0.002	93	0	500	93 19 %	OK	
HW Spotnr	0.002	2035	2035	0	0	OK	
SYNC	0.004	3: TVS ready					
SYNC	0.004	4: beam is on					
SYNC	0.004	9: start spot loop (passed 9 times)					
HW Spotnr	0.004	2035	2035	0	0	OK	
Sweeper	0.004	-2336	-2312	300	-24 -8 %	OK	
ADG3	0.004	6971	6967	348	4 1 %	OK	
RangeShifter	0.004	24	24	0	0	OK	
X	0.004	-41497	-41500	1000	3 0 %	OK	
Y	0.004	-112425	-112499	1000	74 7 %	OK	
Z	0.004	692562	692799	1000	-237 -24 %	OK	
A	0.004	-89984	-90000	500	16 3 %	OK	
B	0.004	93	0	500	93 19 %	OK	
SYNC	0.004	5: beam is off					
SYNC	0.004	6: end of spot from TDS					
Monitor 2	0.004	366	395	258	-29 -11 %	OK	
Ratio M1/M2	0.004	372	393	60	-21 -35 %	OK	
Monitor 3	0.004	450	490	539	-40 -7 %	OK	
U Center	0.006	-12246	-12716	1500	470 31 %	OK	
U FWHM	0.006	13024	13099	4000	-75 -2 %	OK	
U Dose	0.006	2009	2296	3183	-287 -9 %	OK	
T Center	0.006	-3381	-3201	1200	-180 -15 %	OK	
T FWHM	0.006	7839	8800	4000	-961 -24 %	OK	
T Dose	0.006	1816	2177	3174	-361 -11 %	OK	
WD Dose	0.006	34544	34550	3455	-6 -0 %	OK	
WD time	0.006	996	999	299	-3 -1 %	OK	
SYNC	0.006	7: start DoseDataLog					
SYNC	0.006	8: end DoseDataLog					

peering into the control loop ...

Spot Scanning: Operator Tools

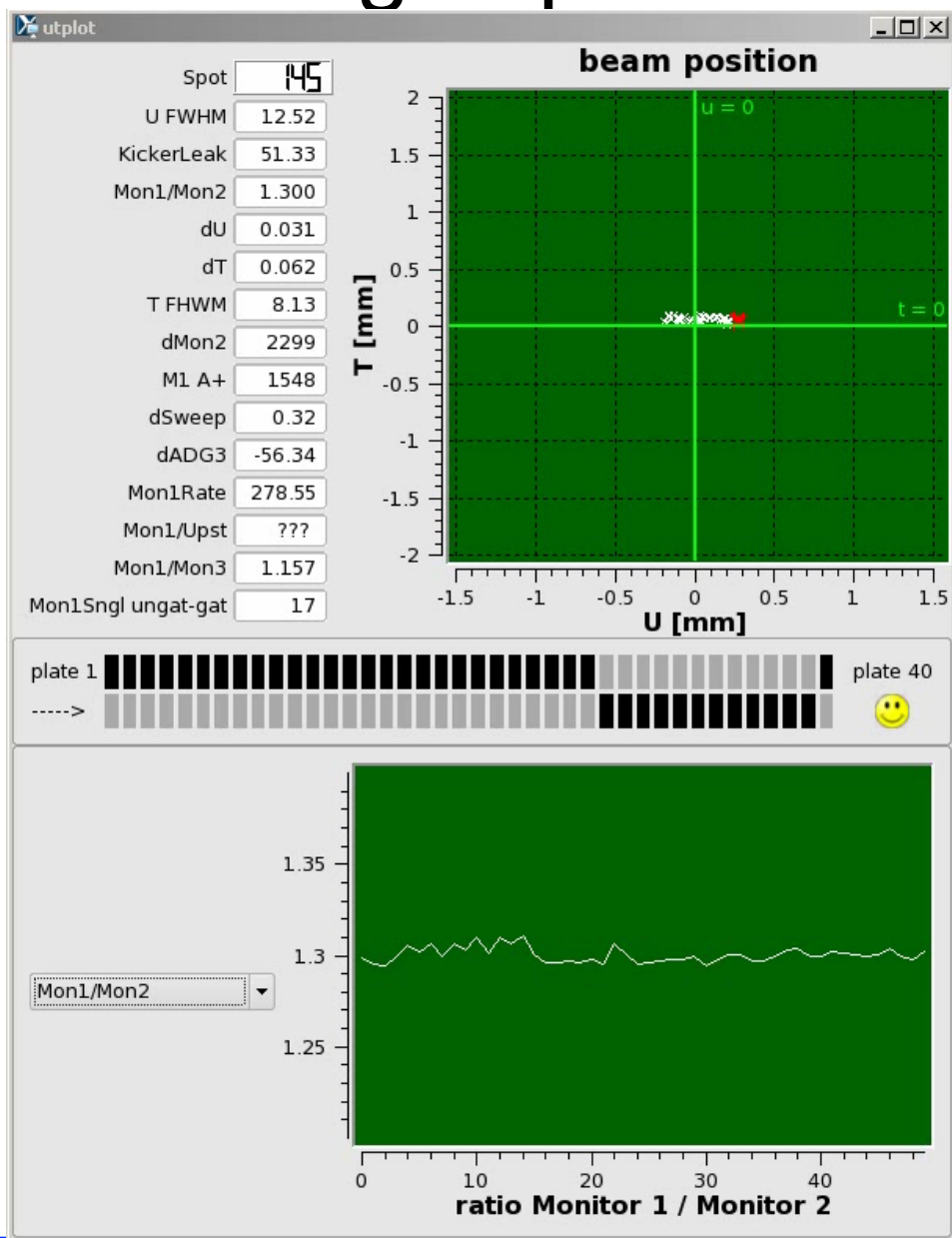

Safe Setting – Redundant Checking – Independent Supervision

Example: Sweeper Magnet Control

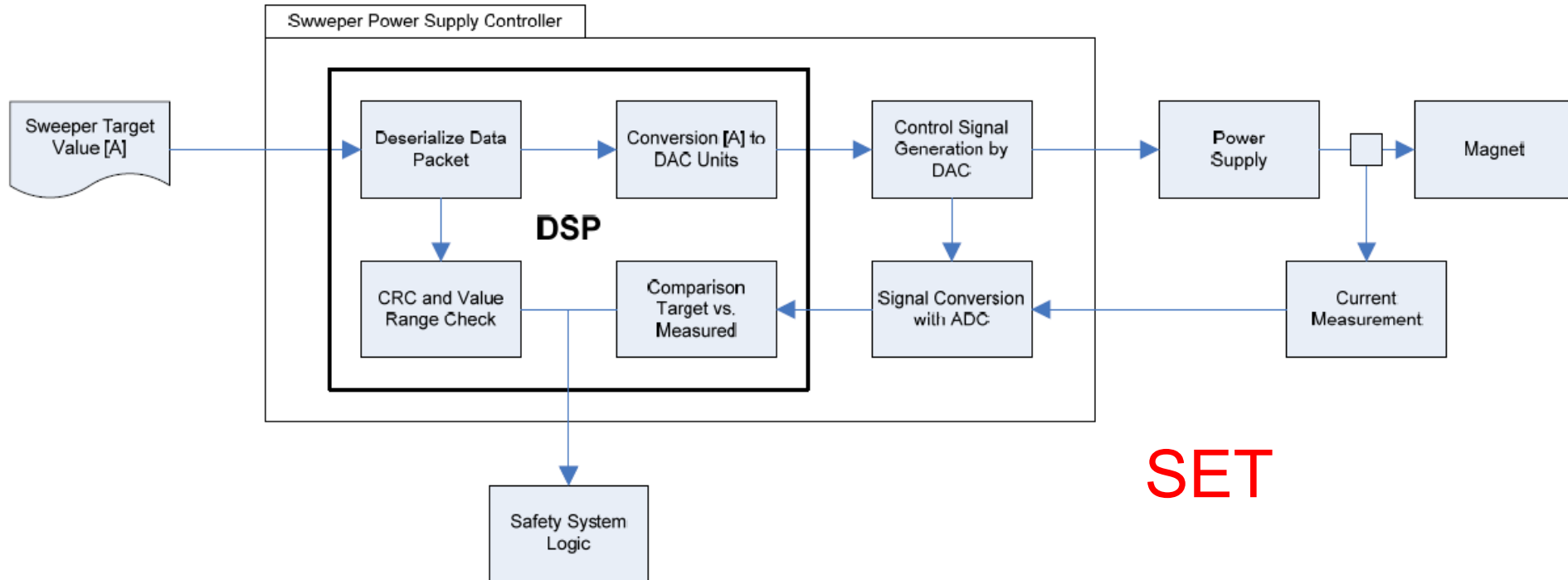

- The sweeper power supply controller receives target values over an optical link from the TCS, checks data integrity, and controls the power supply for the magnet coils
- At the same time, the current through the coils is measured and compared in realtime with the target value on a DSP inside the controller, without TCS involvement. Any deviation beyond tolerance triggers a safety interlock

Magnet Power Supply Control Hardware

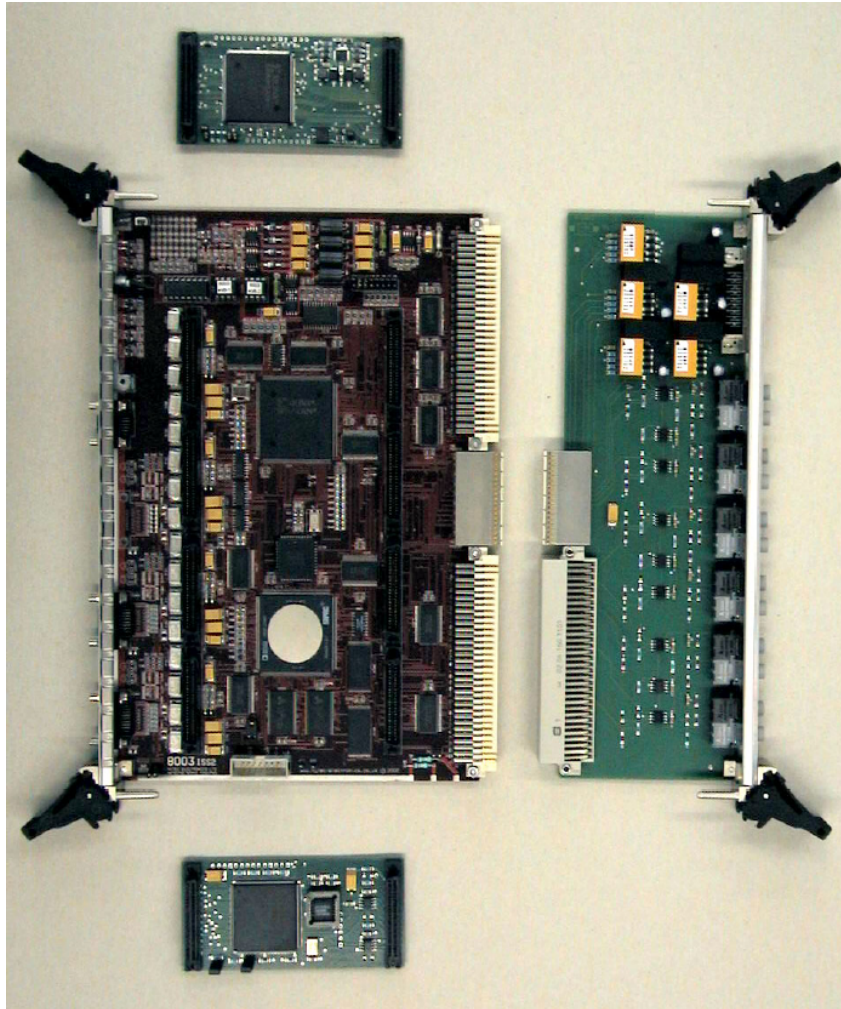

- VME board with 4 Industry-Pack Slots and onboard DSP
- Industry-Packs with FPGA implementing communication interface to power supply
- VME transition module with optical transceivers for data transmission to power supply
- Digitally controlled power-supplies (developped by PSI)

Magnet Power Supply Control Hardware



Example: Sweeper Magnet Measurement

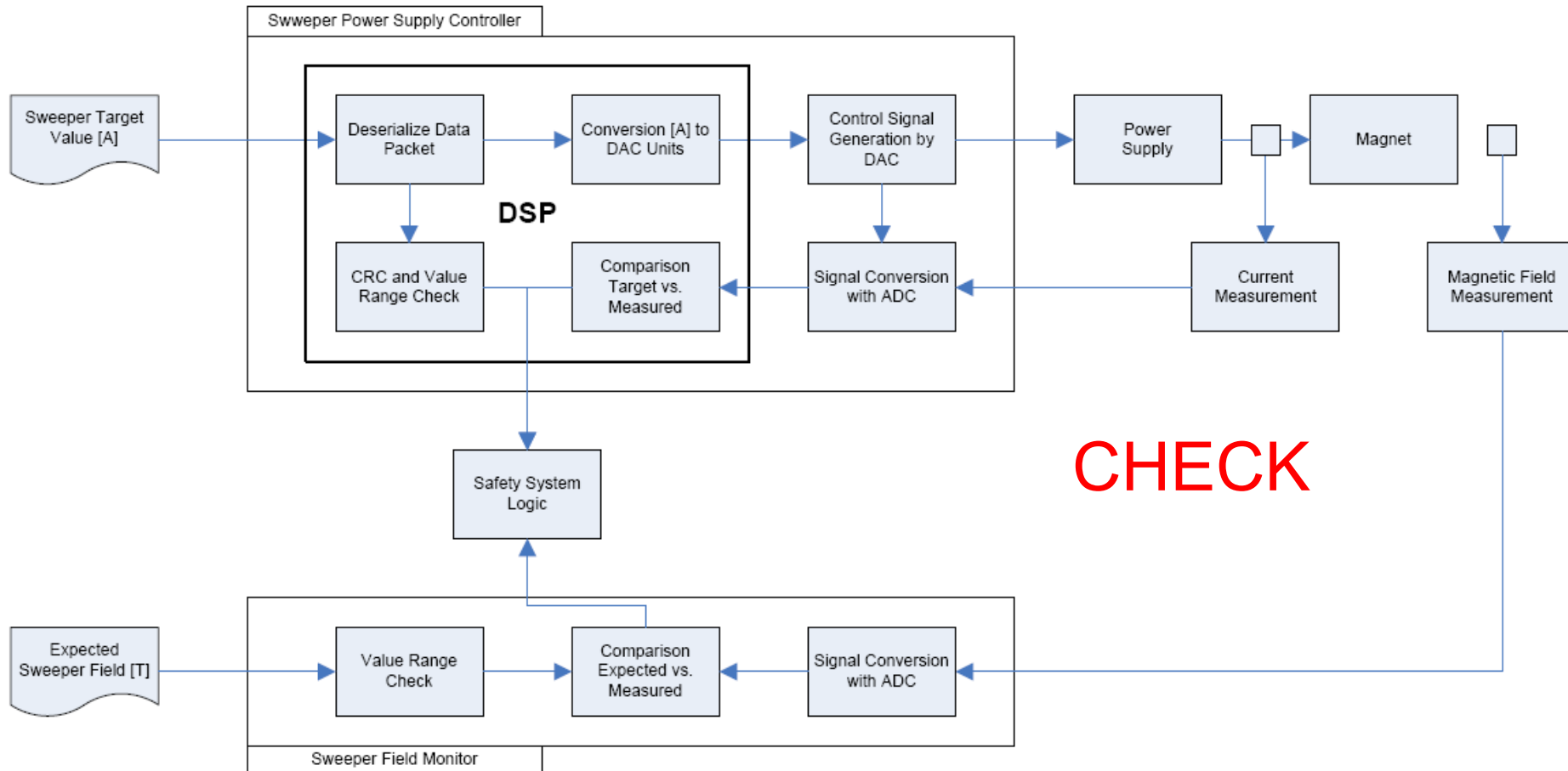

- Monitoring channel is measuring the magnetic field with a hall-sensor and triggers an interlock if a deviation beyond tolerance is detected

Hall Probe used at PSI



Actuation and Monitoring: Implementation

Control Function	TDS Actuation Channel	TVS Monitoring Channel
Beam Position	Sweeper Magnet controlled by DSP based subsystem. Continuous monitoring of power supply setting and state	Hall sensor measuring sweeper magnetic field monitored by TVS. Ionisation strip chamber measuring beam position at exit of nozzle. Monitored by TVS
Beam Tune	Degrader and beamline control through Machine Control System (MCS). MCS implements full actuator supervision	Degrader position and bending magnet hall sensor data continuously monitored by DSP based subsystem
Range Modulation	Control of range-shifter with DSP based subsystem. State of single plates measured with optical sensors supervised continuously	Redundant optical sensors for each single plate. Monitored by TVS
Patient Position	Patient table and Gantry rotation through the Gantry and Patient Positioning System (GPPS). GPPS implements full actuator supervision as well as collision protection	Absolute position encoders and end-switches monitored by TVS

Example: Spot Termination

- General method for dose measurement:
 - Ionisation chambers
 - Current converted to frequency, fed into counter module

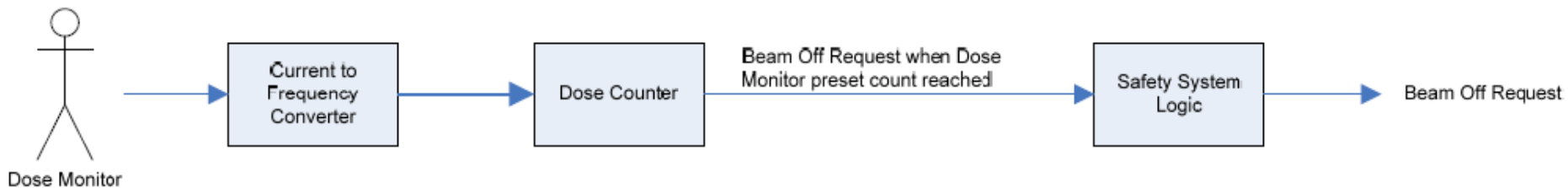

SUPERVISE

Example: Spot Termination

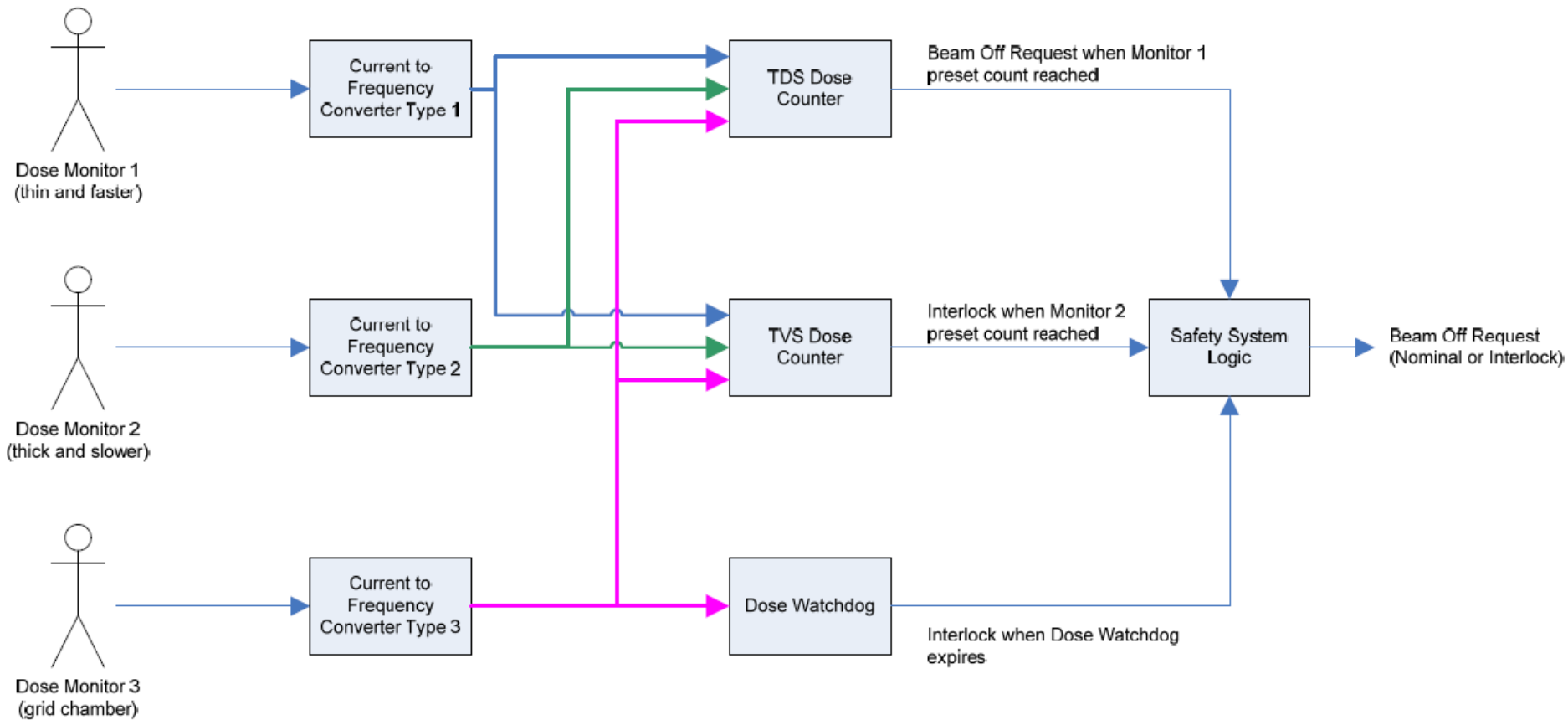

Example: Gantry 1 Spot Termination

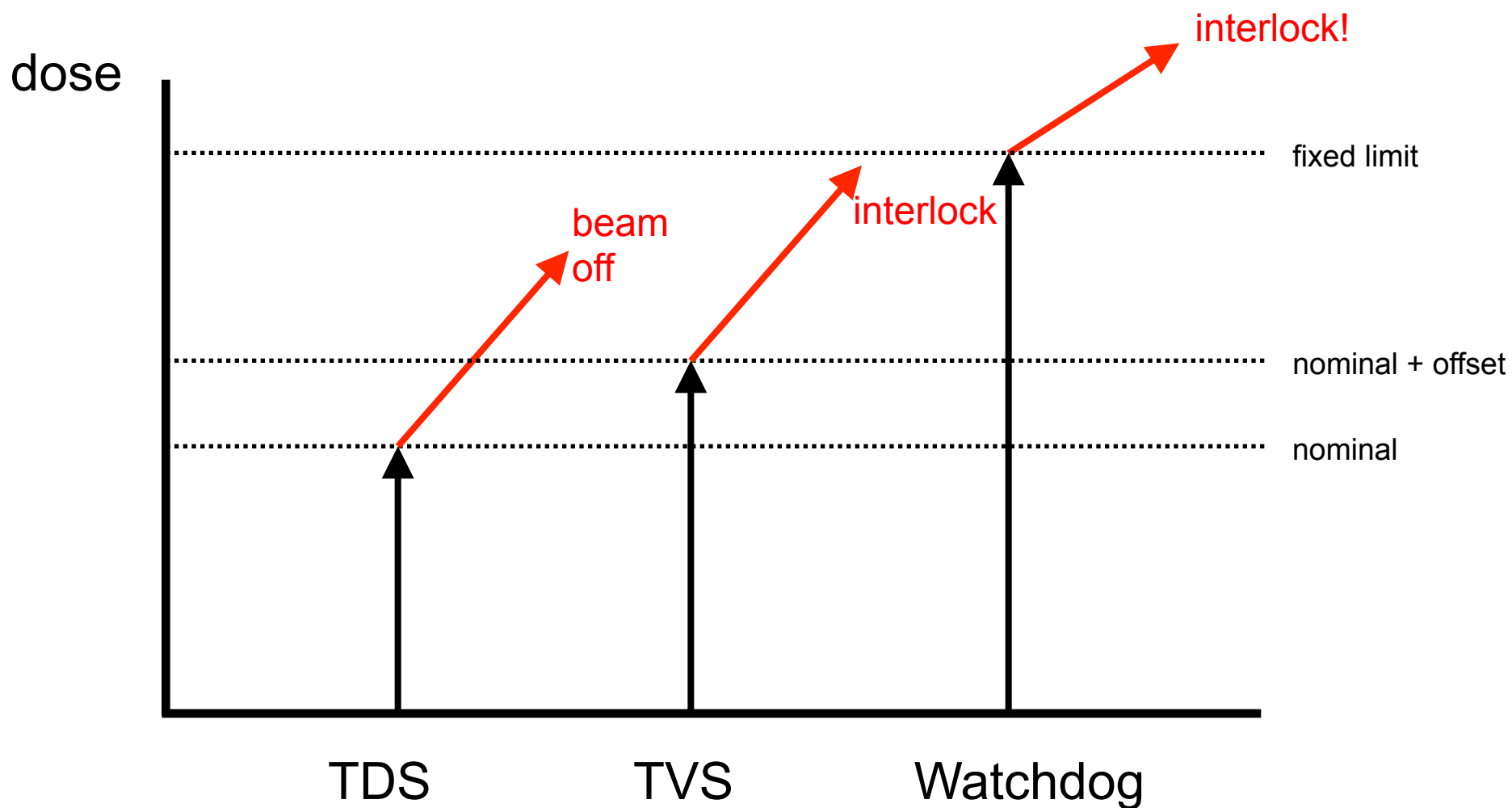

Formal Risk Analysis

- Fault Trees:
 - Start from safety goals
 - Imagine what can go wrong
 - Define measure to reduce associated risks
 - Come up with redundant ways to detect failures and avoid consequences
 - Technical and Operational Measures (TM, OM)
 - Estimate risk before and after applying the measures

Example:

Safety Goal #1 – no serious overdose

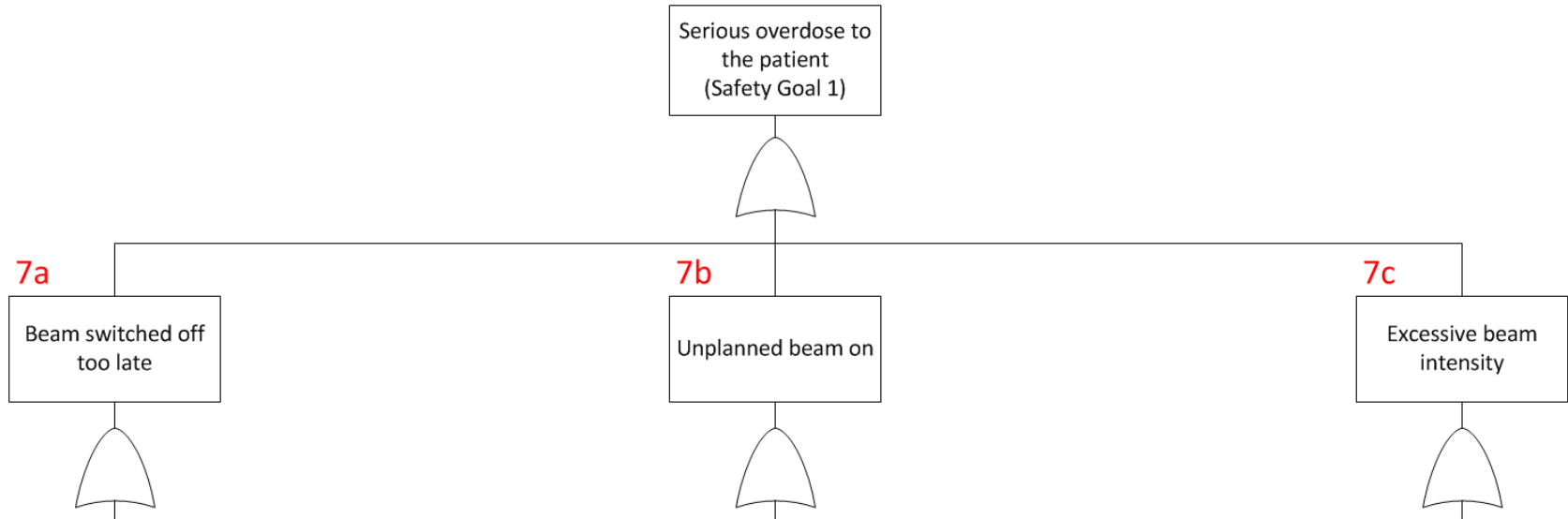

Example:

Safety Goal #1 – no serious overdose

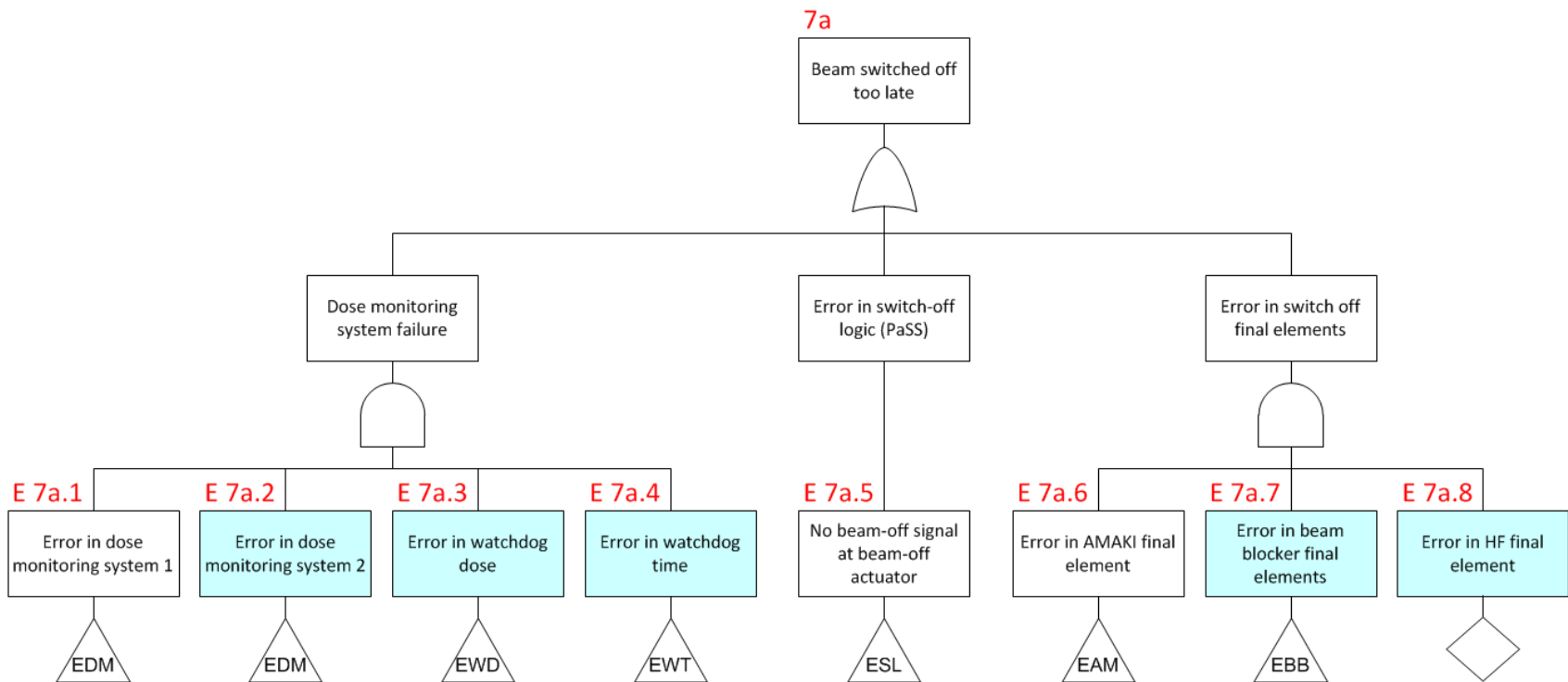

Example:

Safety Goal #1 – no serious overdose

- E 7a.1** **Error in Dose Monitoring System 1**
- TM 7a.1.1** **A beam *switch-off* is activated upon saturation of the Monitor.**
- TM 7a.1.2** **The high-voltage supply to the Monitor is continuously monitored.**
- TM 7a.1.3** **The monitor units are transmitted together with a heartbeat signal.**
- TM 7a.1.4** **The dose is measured by two independent monitoring systems, connected to TDS and TVS, respectively.**
- TM 7a.1.5** **In case a failure of the front-end electronics is detected, an interlock is generated.**
- OM 7a.1.1** **The gain and offset of the front-end electronics of the Monitor is checked daily.**

Risk Categorization

Severity

Index	Severity	
1	Negligible:	little or no effect
2	Minor:	minor injury (benefit > harm)
3	Marginal:	moderate injury (benefit insecure)
4	Critical:	serious injury (harm > benefit)
5	Catastrophic:	death(s) or multiple serious injuries

Occurrence

Index	Occurrence		
1	Incredible:	< once in 100 years	< 1 / 1'800'000 fields
2	Improbable:	once in 10 years	1 / 180'000 fields
3	Remote:	once per year	1 / 18'000 fields
4	Occasional:	once per month	1 / 1'500 fields
5	Probable:	once per week	1 / 350 fields
6	Frequent:	once per day	1 / 70 fields

Risk Categorization

		Severity				
		1 Negligible	1 Minor	3 Marginal	4 Critical	5 Catastrophic
Occurrence	6 Frequent	C	C	C	C	C
	5 Probable	B	C	C	C	C
	4 Occasional	A	B	C	C	C
	3 Remote	A	B	B	C	C
	2 Improbable	A	A	B	B	C
	1 Incredible	A	A	A	B	B

Risk Index	Acceptance Criteria
A	Acceptable without additional actions.
B	Acceptable. Risk reduction required if practicable with a reasonable effort (ALARP ¹⁵).
C	Unacceptable. Corrective actions must be taken.

Risk Evaluation

E 7a.1 Error in Dose Monitoring System 1

The Dose Monitoring System 1 regularly terminates the spots with the beam *switch-off* control function. Any error in this system could result in the beam not being switched-off as intended at the end of the spot. The measures described in the following sections, are in place to detect errors in the Dose Monitoring System 1 and to ensure that, following an error, a safe state is regained.

Risk eval.:	Before	Sev _{np}	Occ _{np}	RI _{np}	After	Sev _p	Occ _p	RI _p
	measures	3	5	C	measures	2	1	A

Patient Safety System PaSS

- Elements of (any) safety system:

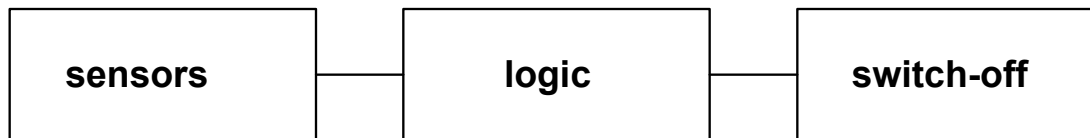

Elements of a safety system



Elements of a safety system

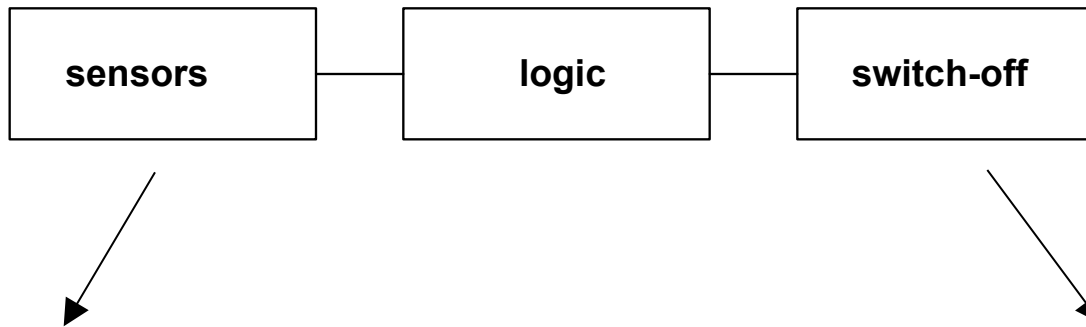

beam detectors
Hall-probes (magnetic field)
end switches (beam blocker)
...

achieve / maintain safe state
= no beam, no mechanical movement

kicker magnet
beam blocker
radio frequency
ion source

Example: measuring beam position with strip detectors

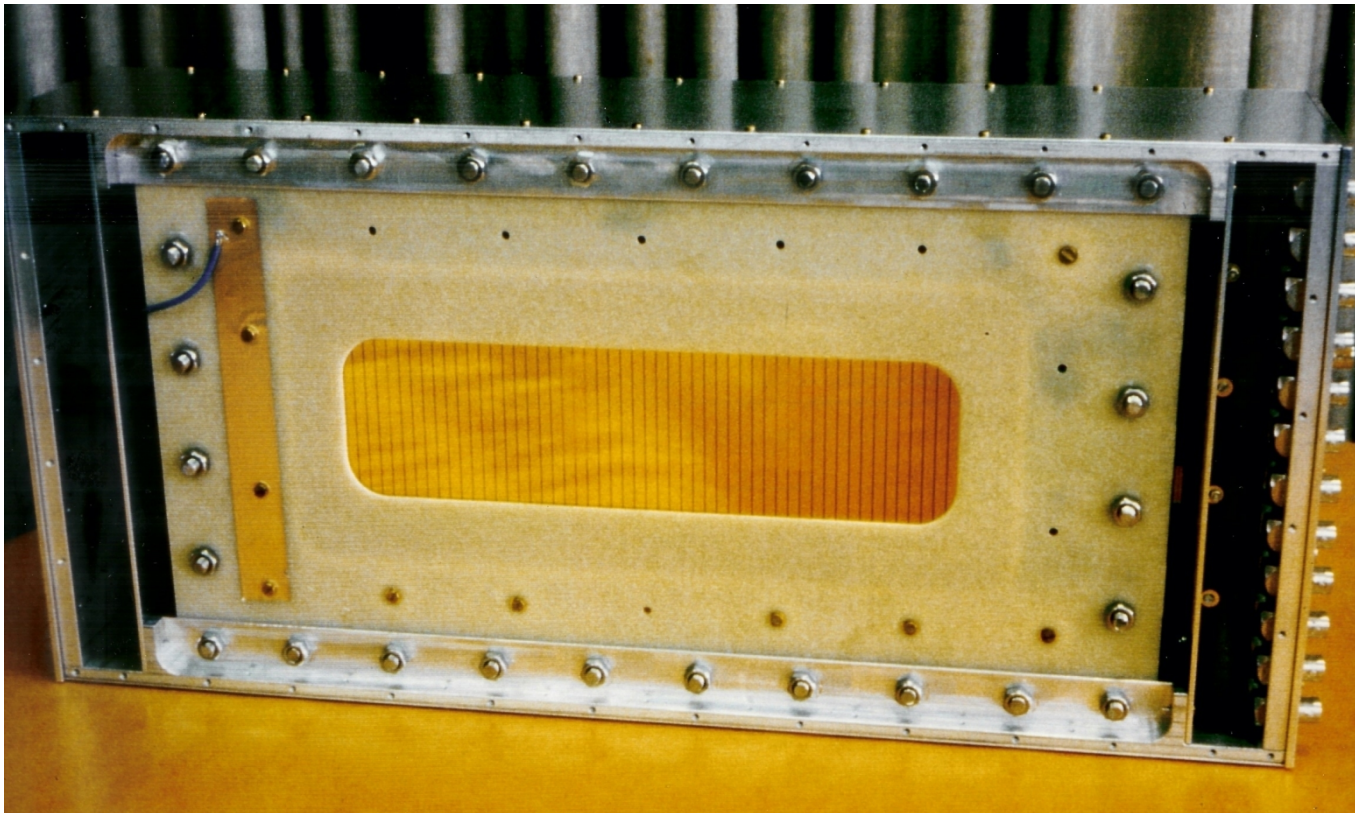

Measuring beam position

- read out strips after each spot
- determine position and compare with nominal value
- if deviation > tolerance:
→ beam switch-off by PaSS! („interlock“)

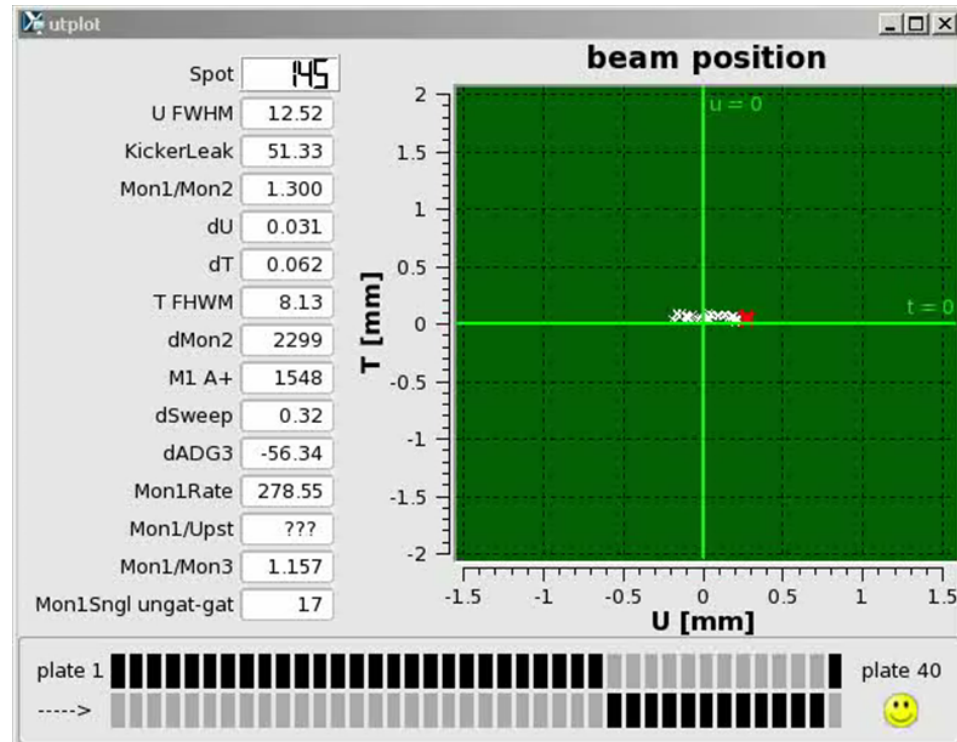

- Local & central final elements
→ local & central logic subsystems

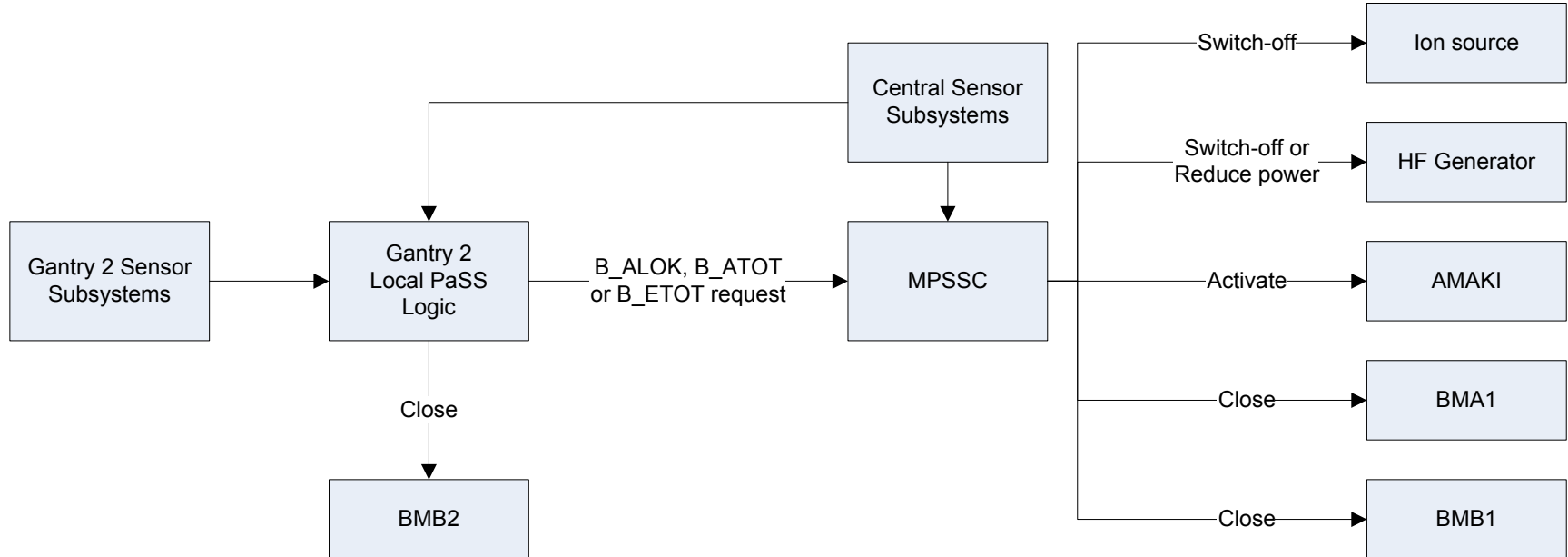

PSI Safety System Hardware

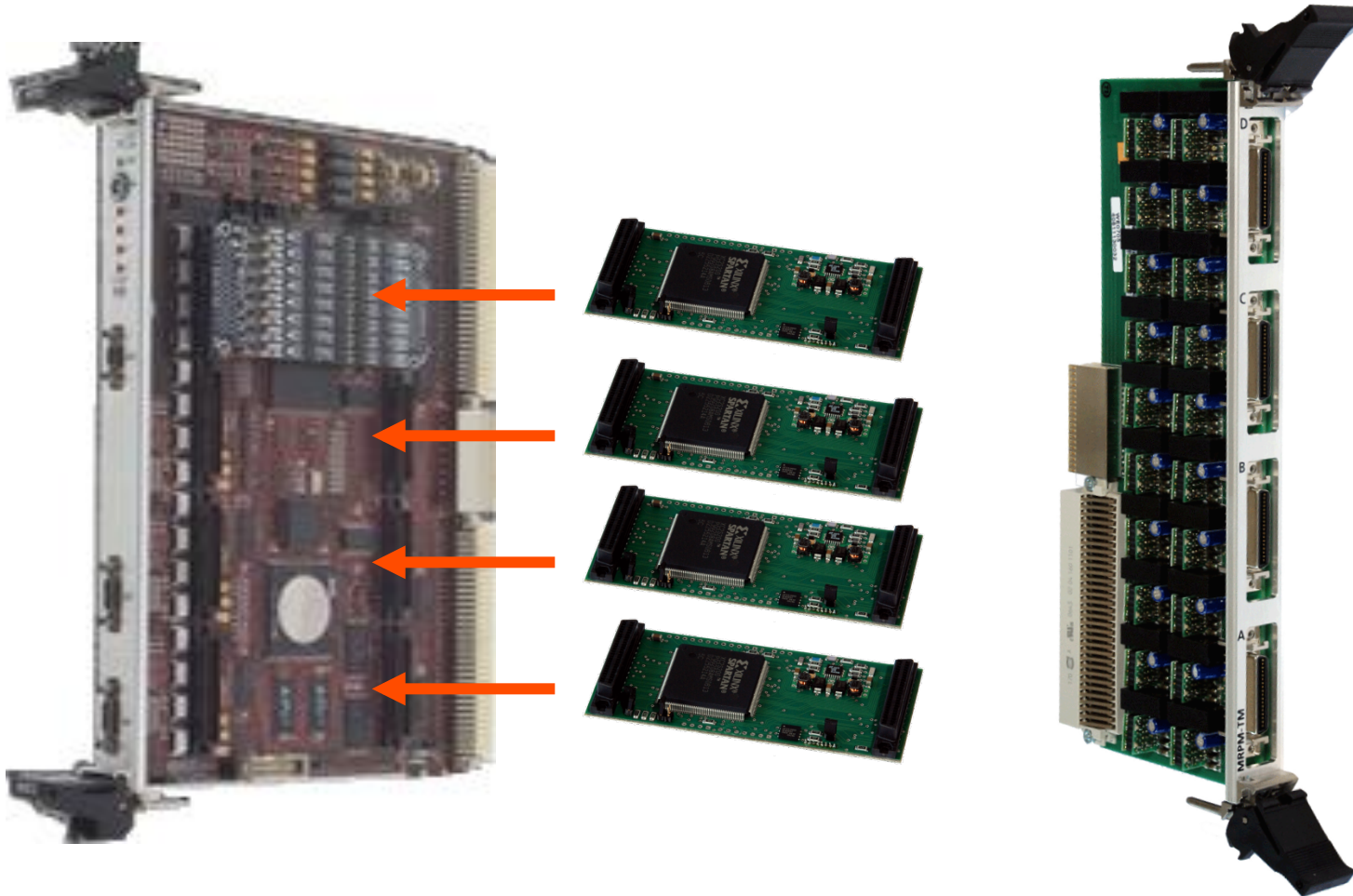

HYTEC Carrier Board
(Type VICB8003.2)

FPGA Moduls
(Based on XILINX Spartan-II)

Transition Module
(Type TILK)

PSI Safety System Hardware

- Interconnections made via Patch-Pannels
- Possibility to bridge signals by hardware

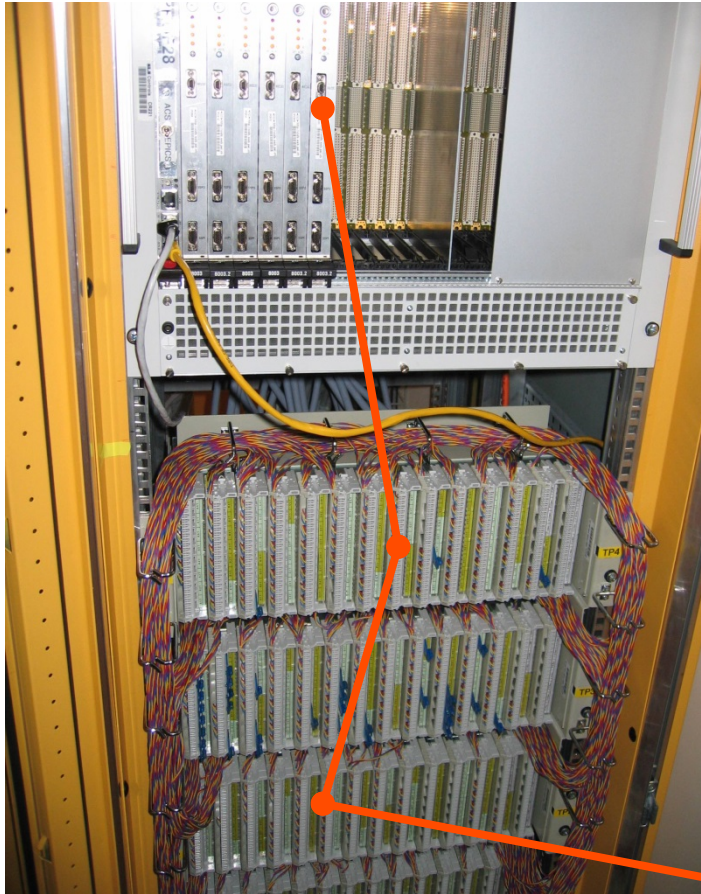

3-wire current loop interface

To/From Sensor Subsystem / Final Element

How do we switch off the beam?

(«Final Elements»)

Proscan Final Elements

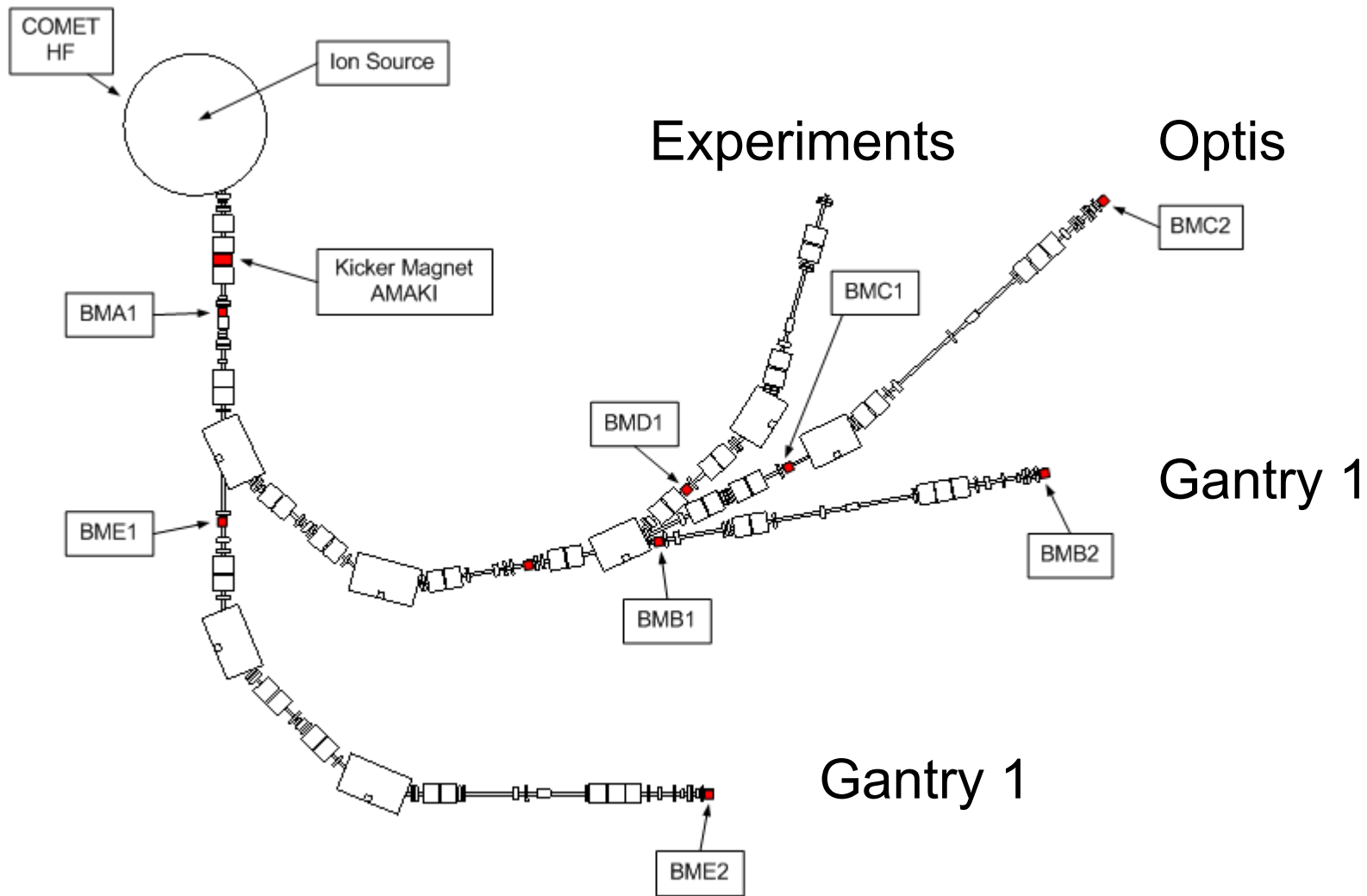

Kicker magnet

- Magnet deflects beam out of axis
- Switch-off in $< 300 \mu\text{s}$

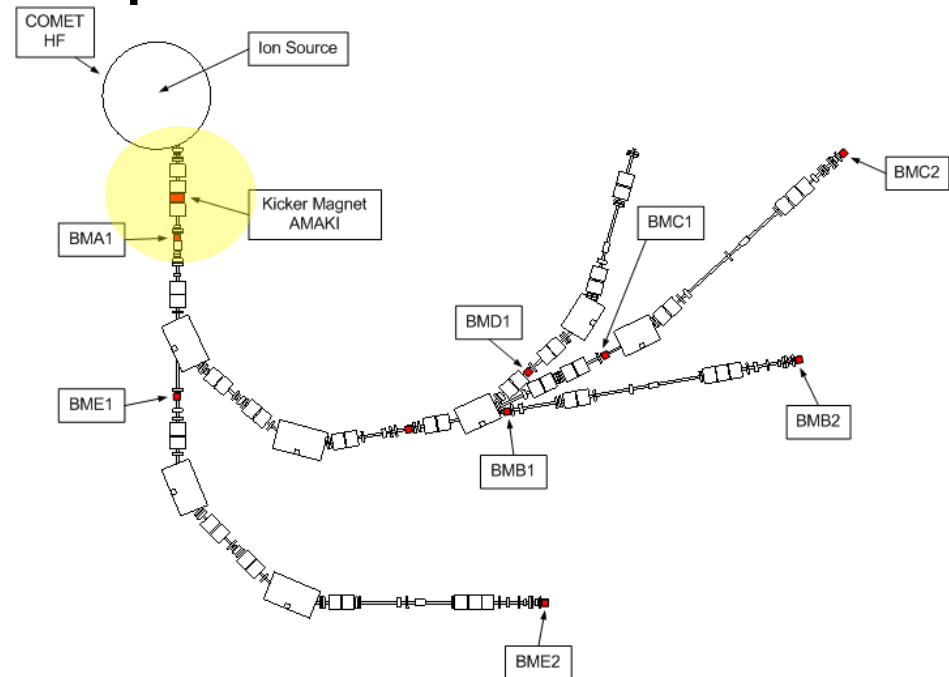

High Frequency Generator

- 2 Levels:
- Reduce power to 20%
- De-energize completely
- Switch-off in $< 400 \mu\text{s}$

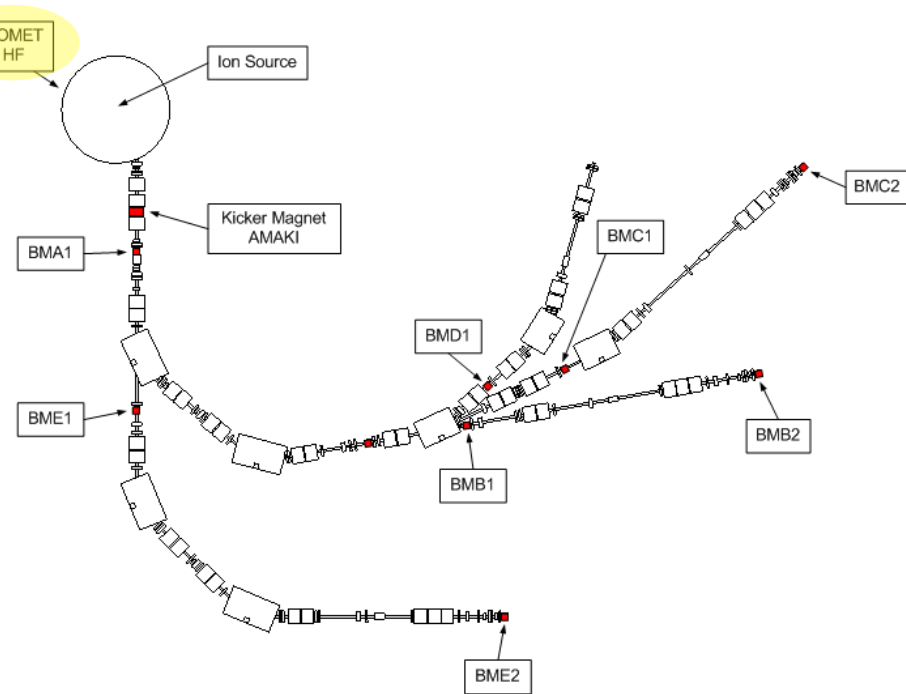

Ion source

- De-energize ion source
- Switch-off in < 20 ms

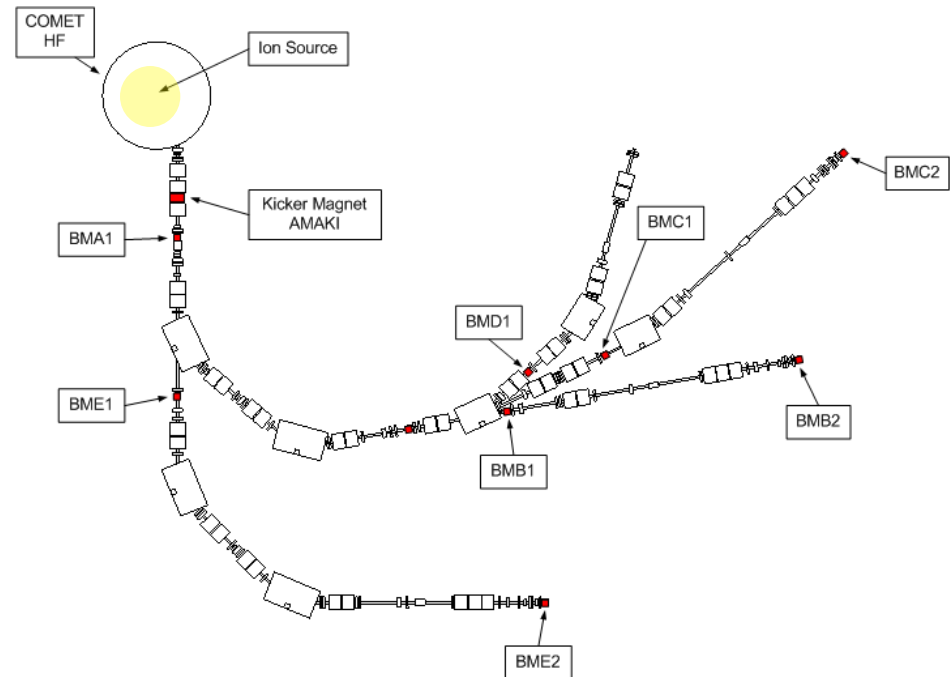

Fast Mechanical Stoppers

- copper block 5 cm length
- moved by pressured air & mechanical spring
 - Switch-off in < 100 ms

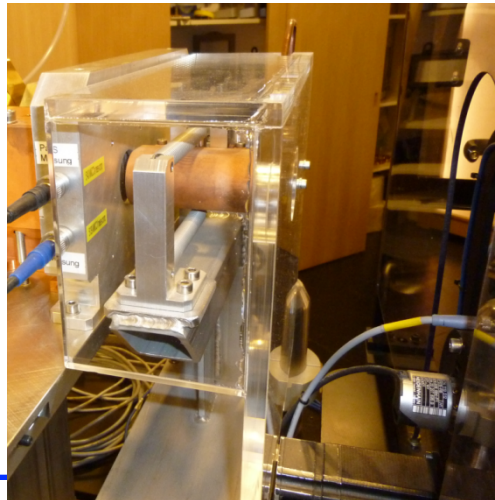
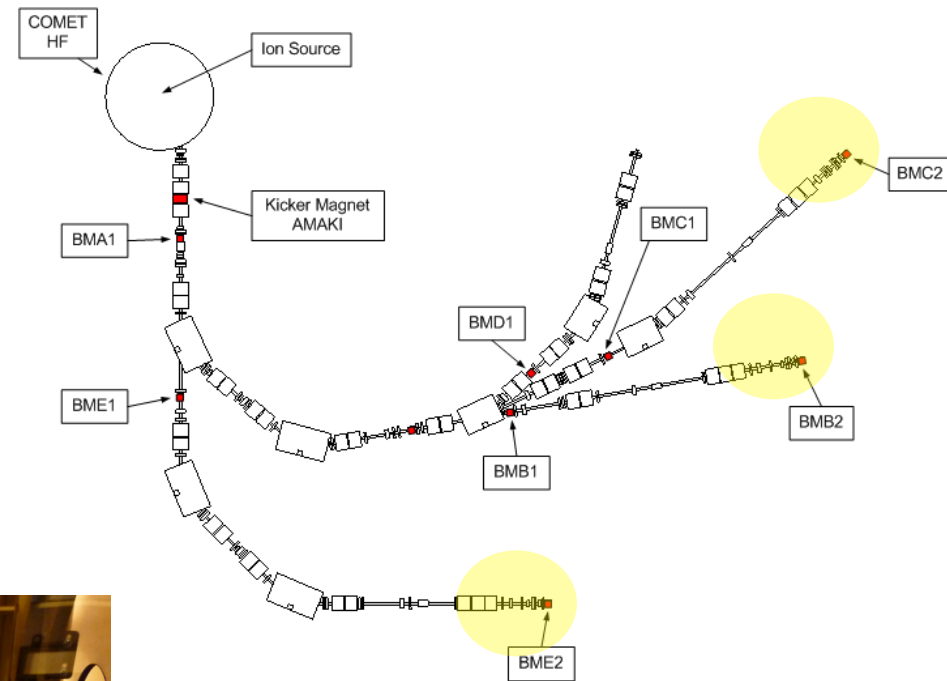

Slow Mechanical Stoppers

- Graphite blocks up to 25 cm
- moved by pressured air & gravity
- Switch-off in < 1 s

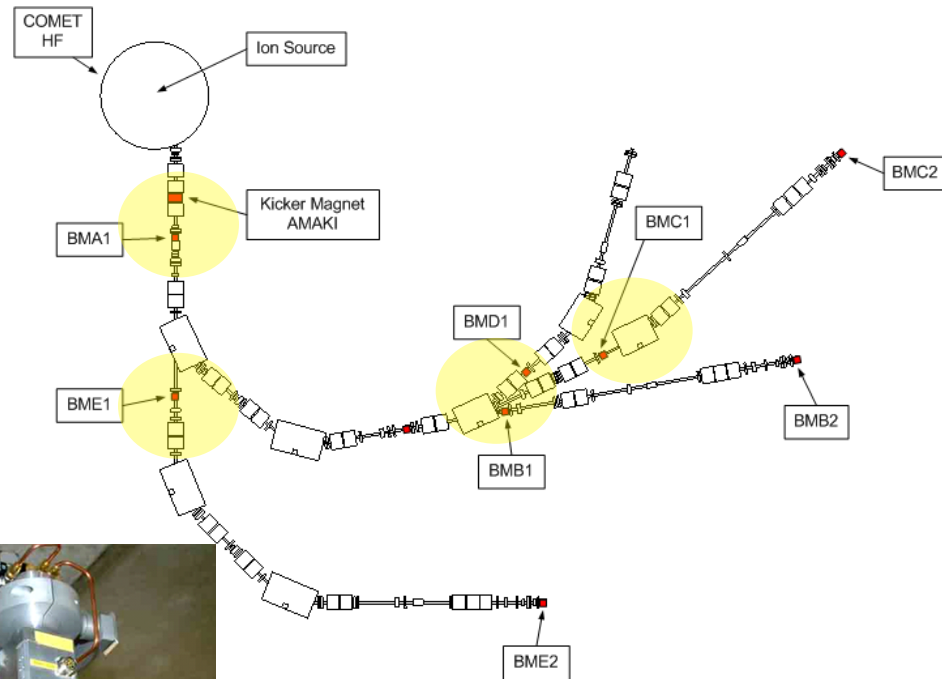

3 Interlock-Levels

Final Element	Control Function	Safety Function		PaSS Components
BMB2		ALOK		local PaSS
AMAKI	beam off		escalates	
BMB1		ATOT		MPSSC
BMA1				
HF reduced			escalates	
HF off			ETOT	E_OR
IQ off				

Recovery of failing beam switch off

Paragraph in this report	Failure of final element			Recovered by	Reaction time till next fastest final element reacts	Extra dose delivered using regular settings (60 Gy total dose; 6 Gy/s dose rate)		Extra dose delivered using hypofractionation (10 Gy total dose; 6 Gy/s dose rate)	Extra dose delivered if beam current excursion by factor 10 (100 → 1'000 nA)
					ms	Gy	% of total dose (60 Gy)	% of total dose (10 Gy)	% of total dose (60 Gy)
10.4.1.1	AMAKI + HF reduced + HF off + IQ off + BMB2			HF reduced	0.70	0.0042	0.007	0.042	0.07
10.4.1.2				HF off	0.98	0.006	0.01	0.06	0.1
10.4.1.3				BMB2	60	0.36	0.6	3.6	6.0
10.4.1.4				BMB1, BMA1	1'000	6.0	10	60	100

The concept of Mastership

- Control over central components (degrader, kicker magnet, ...) granted to 1 treatment area alone

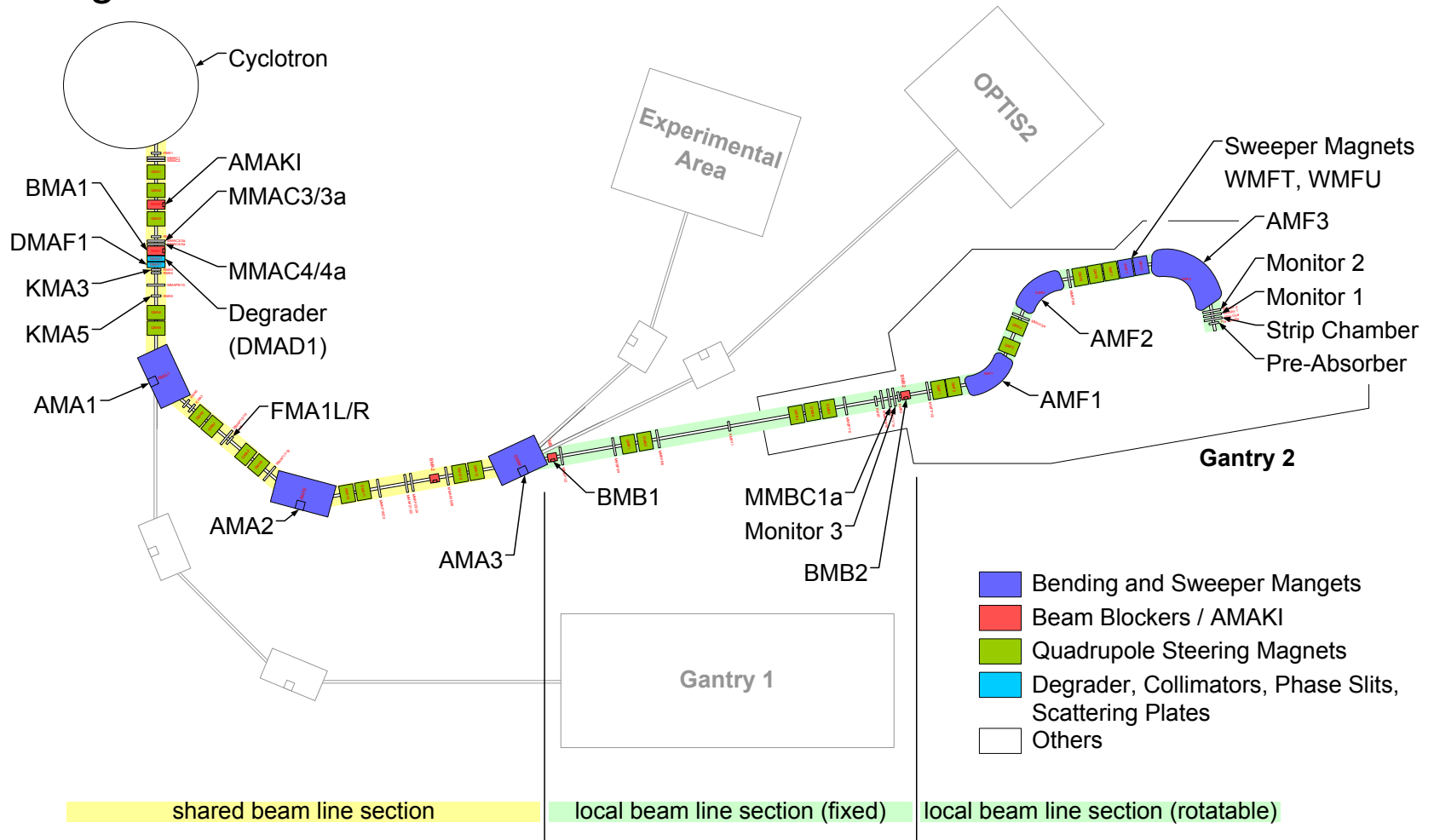

The concept of Mastership

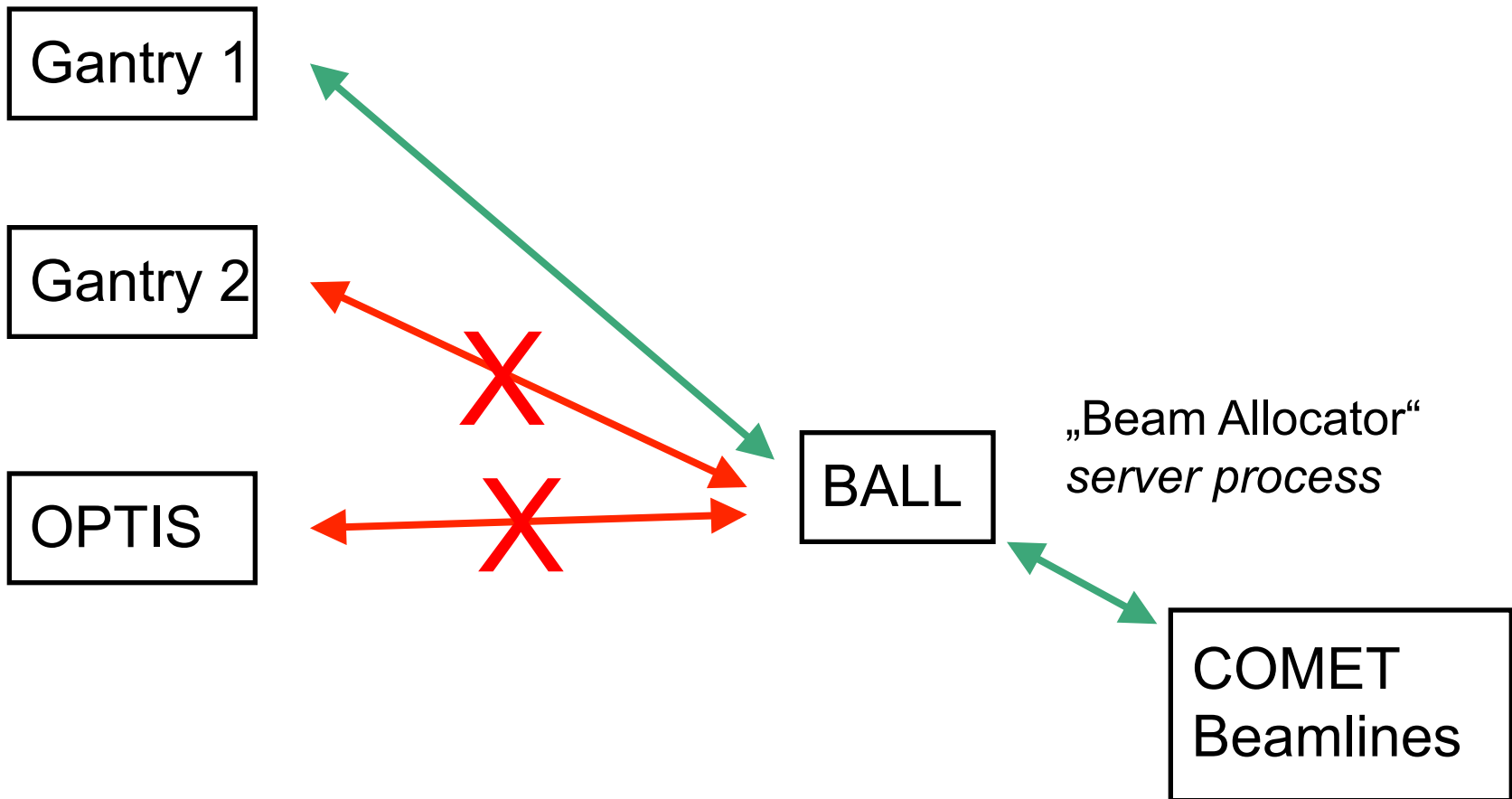

Mastership verification

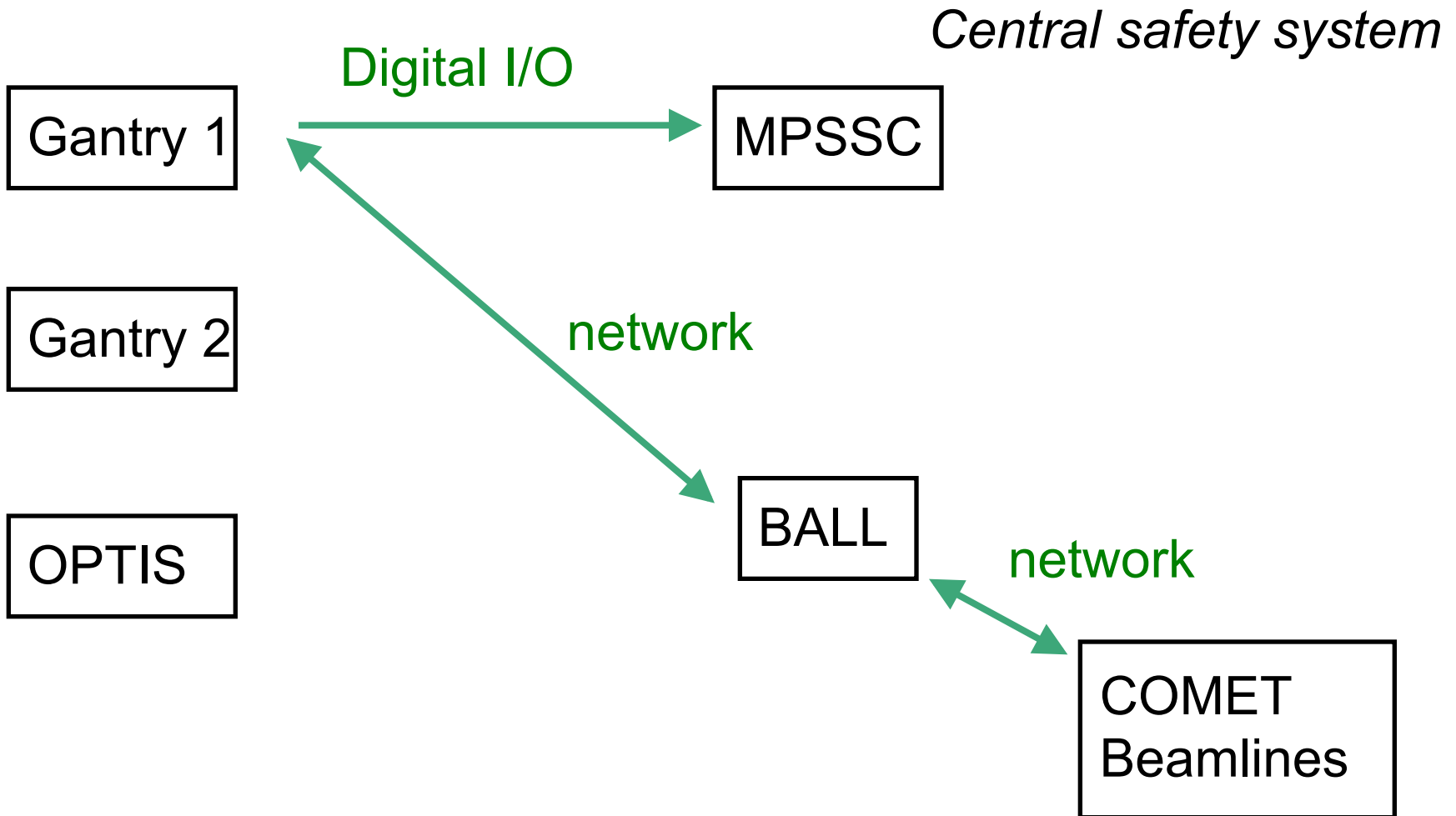

Mastership verification

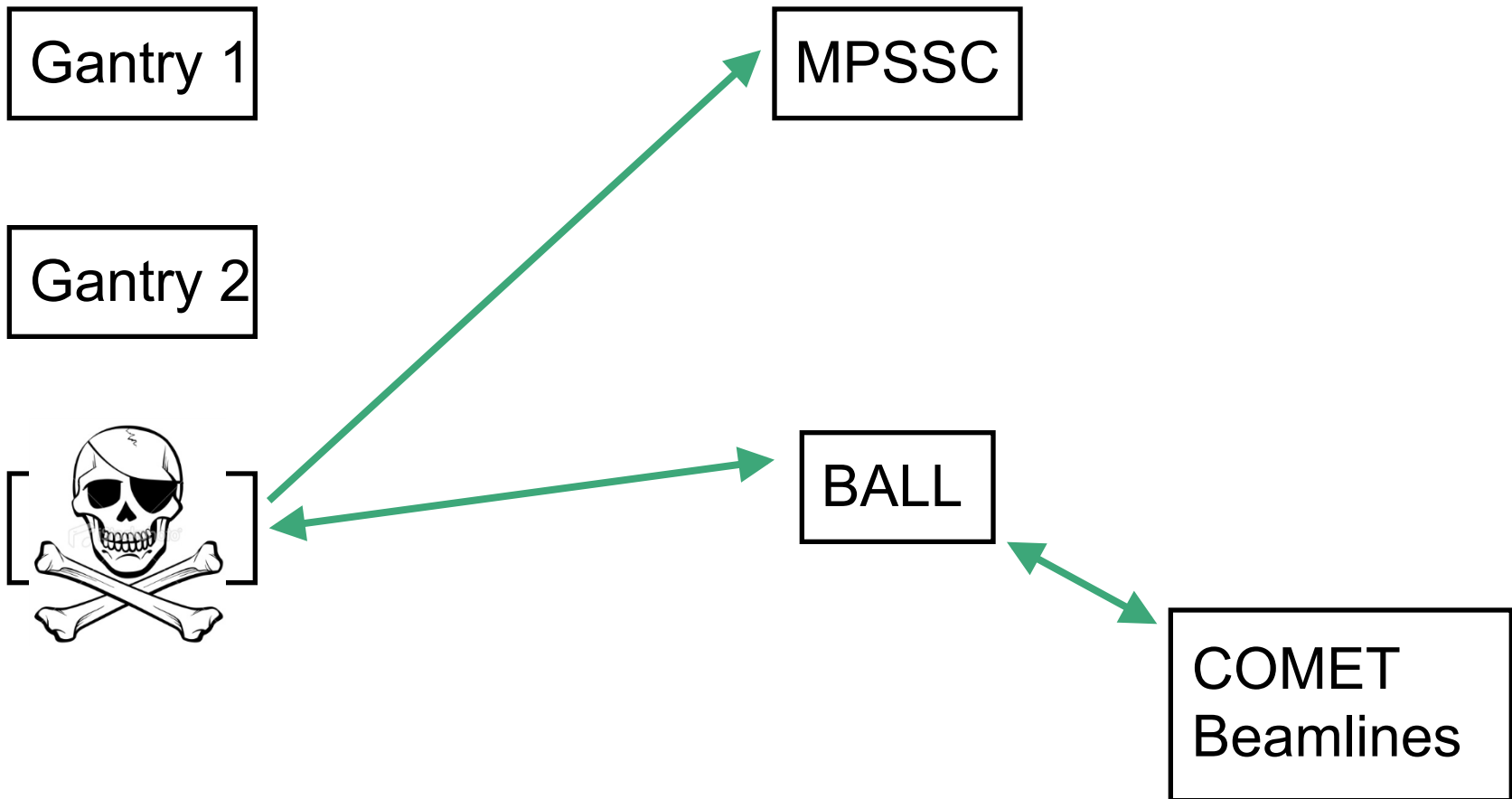

Mastership verification

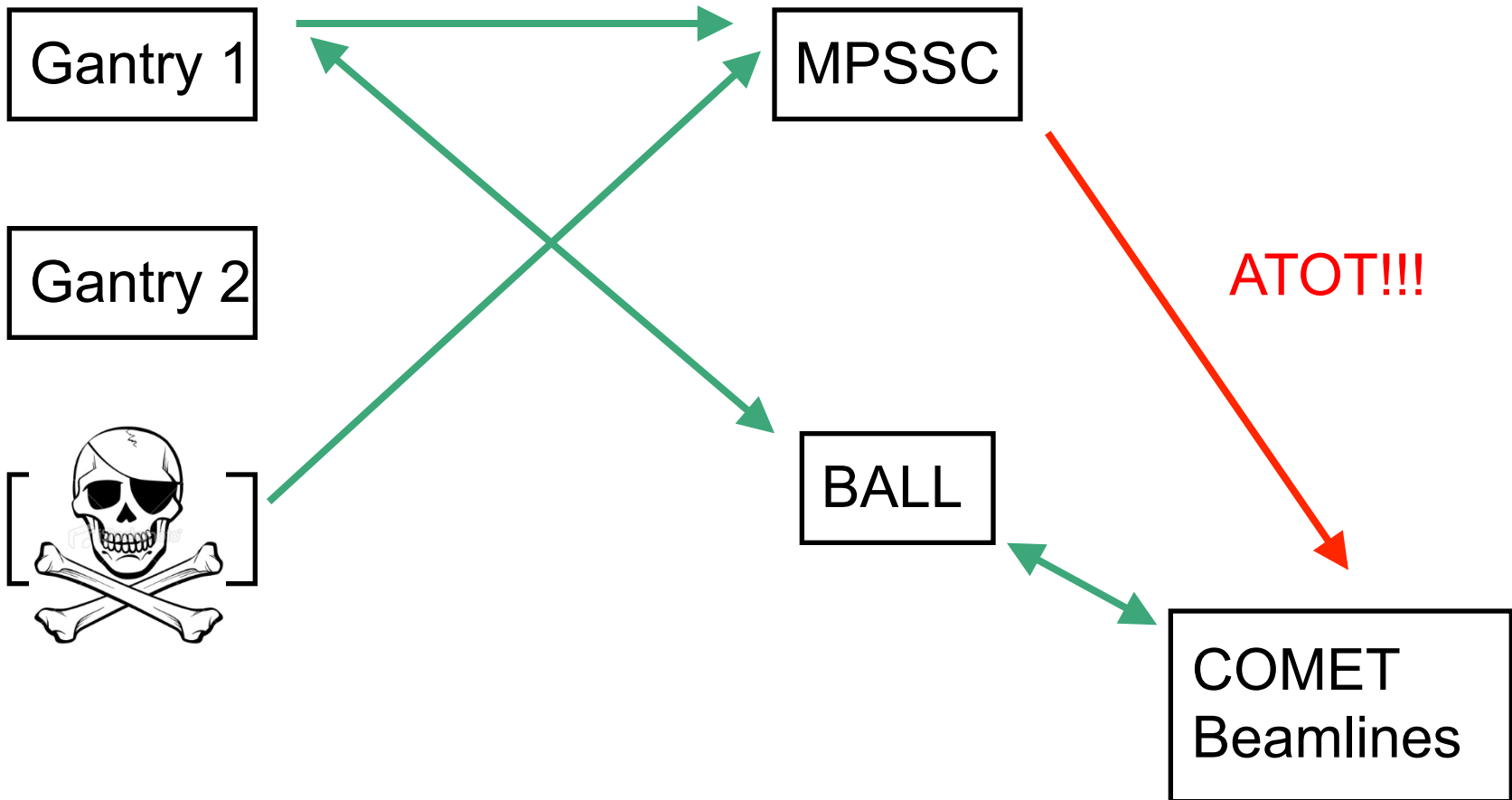

Integration of Gantry 3

- Commercial Gantry including Control System
- Still needs access to central elements
 - Setting beam energy & intensity
 - accelerator & beamline control
 - Beam on/off control → Kicker magnet
 - Interlocks → final elements
- Definition & Implementation of Interfaces
 - Software (network) and Hardware

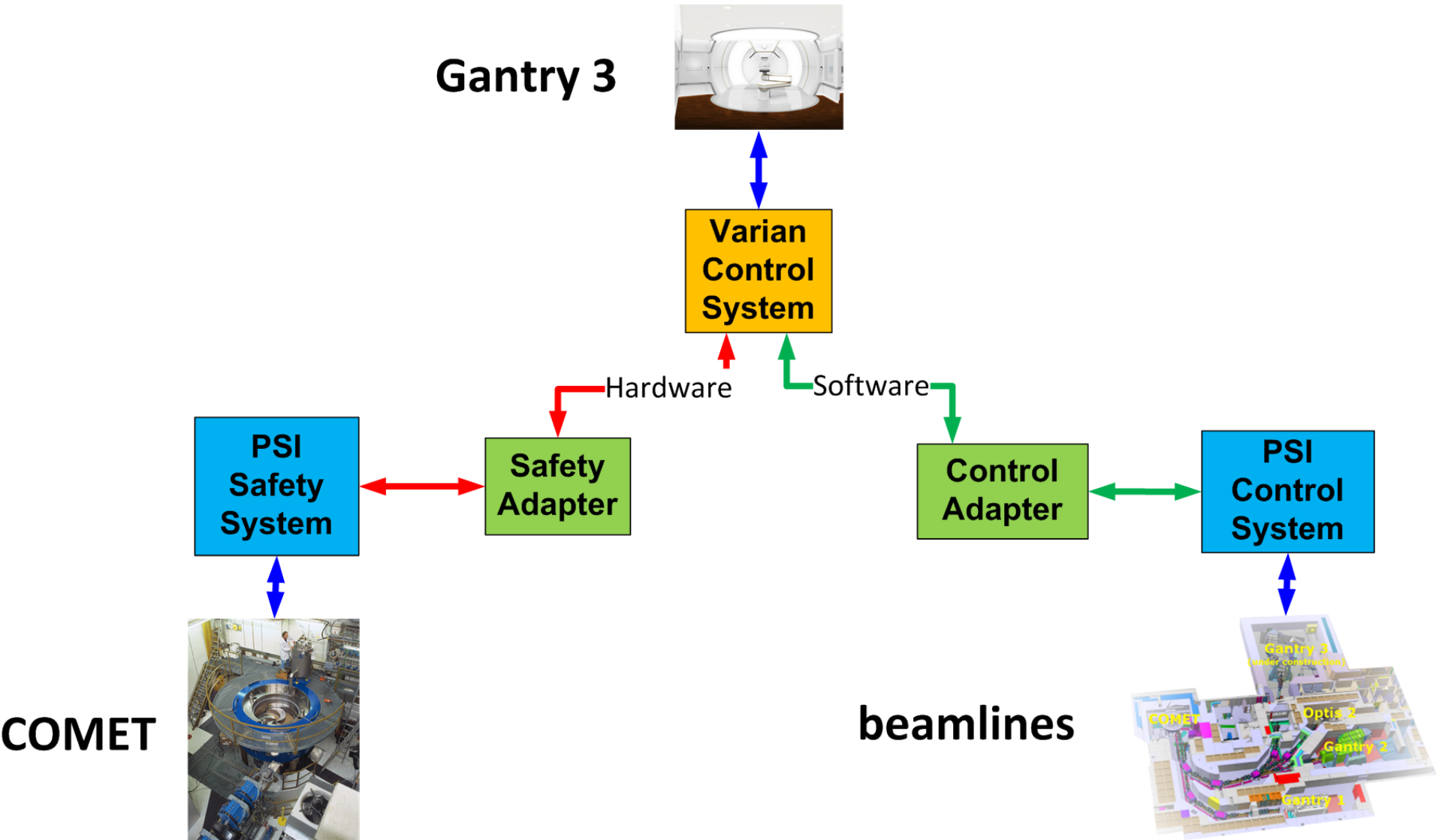

Control Adapter

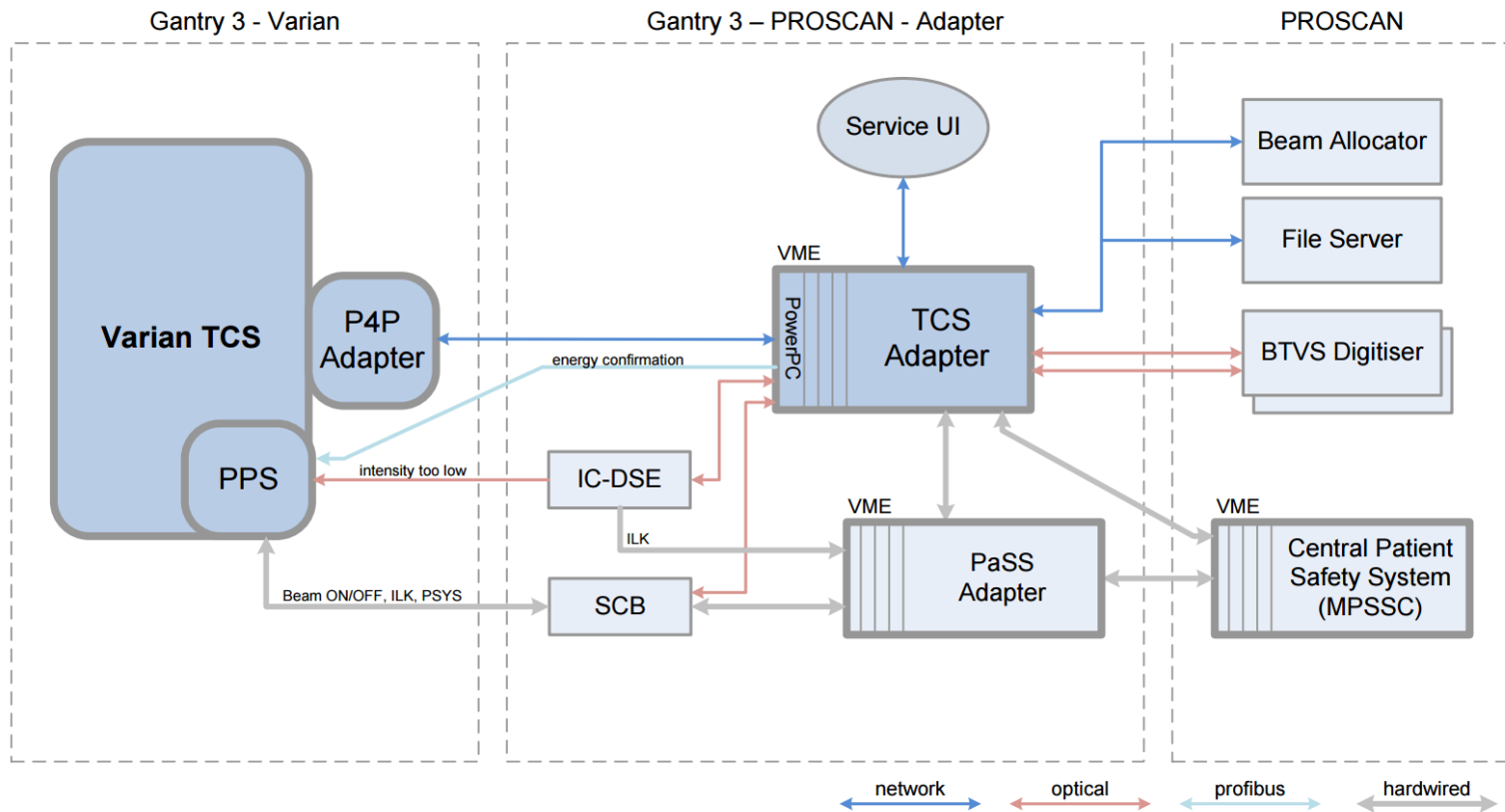

Safety Adapter

- HW based on IFC1210 (www.ioxos.ch)

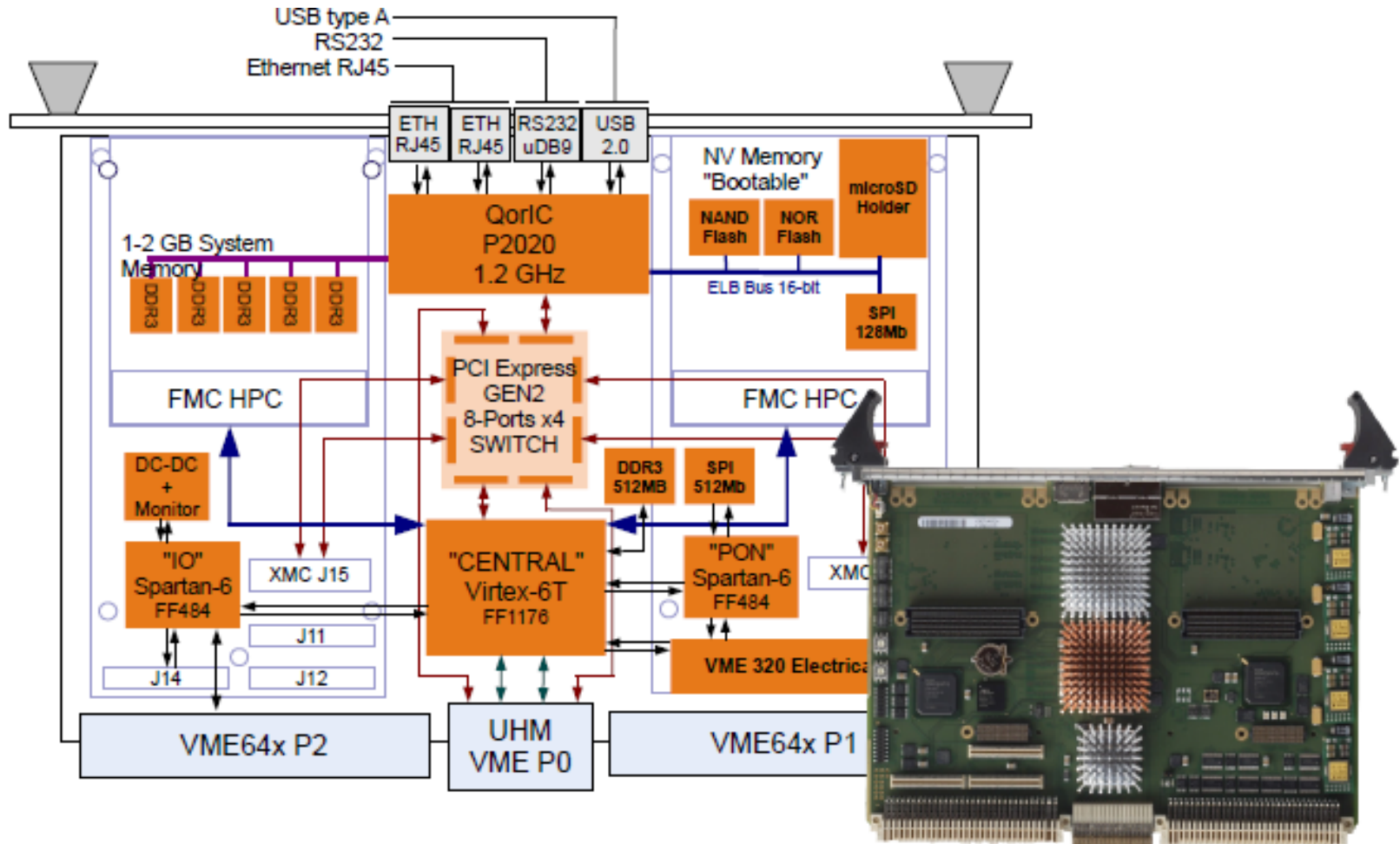

Safety Adapter

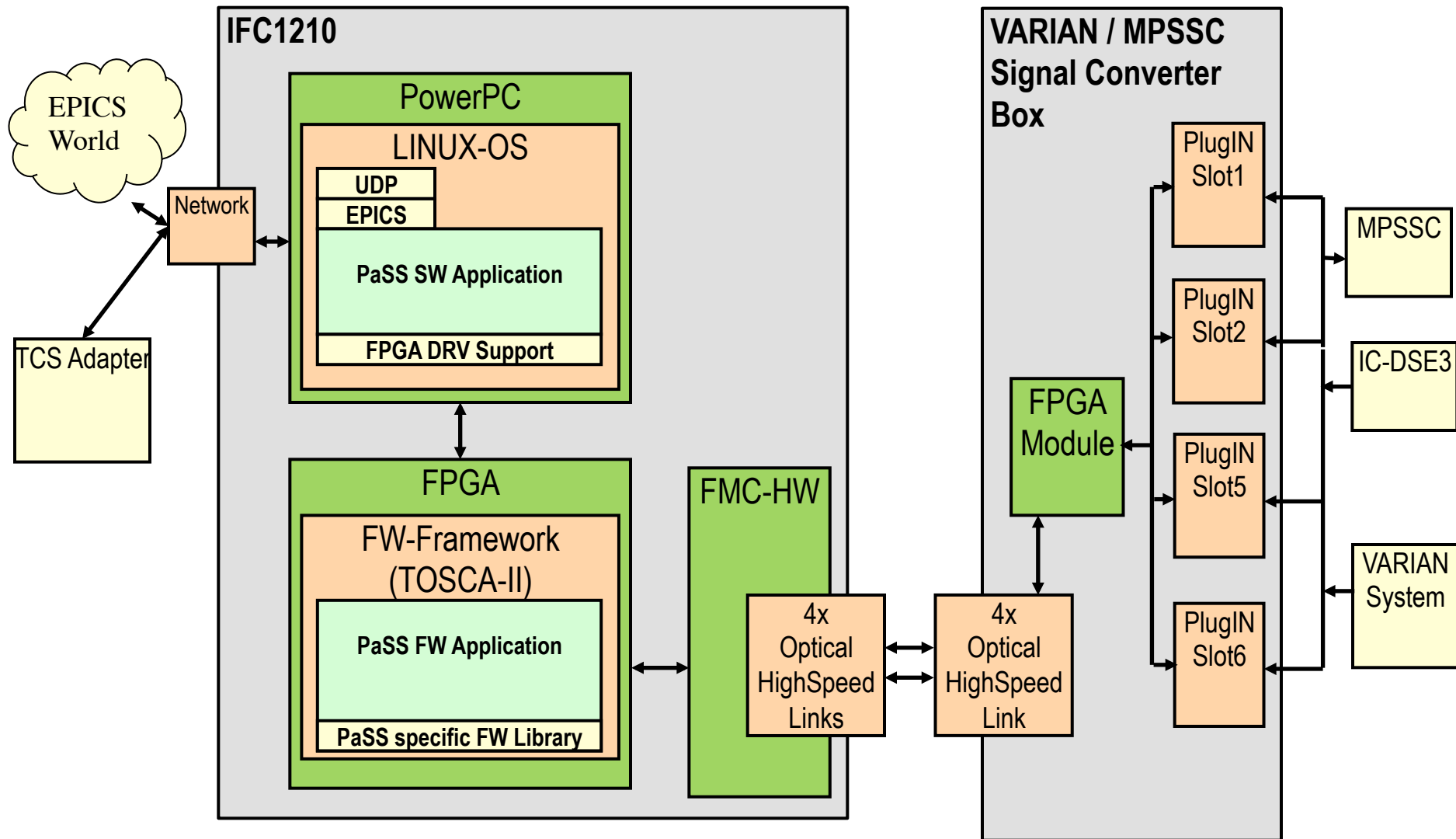

Signal Converter Box

VARIAN / MPSSC Signal Converter Box

Simple HW box, which fits into 19 inch crate
Interfaces:

- 4x high speed optical links – SFP transceivers
- Interface to FPGA COTS module (e.g. ENCLUSTRA – Like used in G2 – MCCS Project)
- 6x interface slots for connecting CPT standard PlugIn family. This family supports several interface standards.

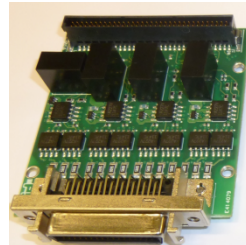

PSI
3-wire

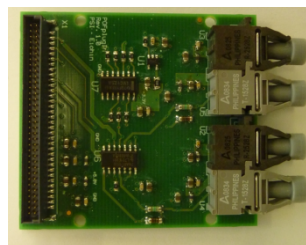

optical

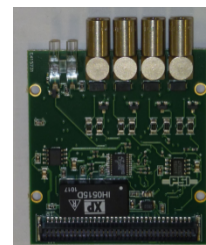

Analog
+/-10V



5V TTL



LVDS

- FPGA design supporting HighSpeed optical link communication and IO communication to PlugIn slots
- Supporting VARIAN interface requires additional development of PlugIn boards
- Complexity: Simple HW design and medium complex FPGA design

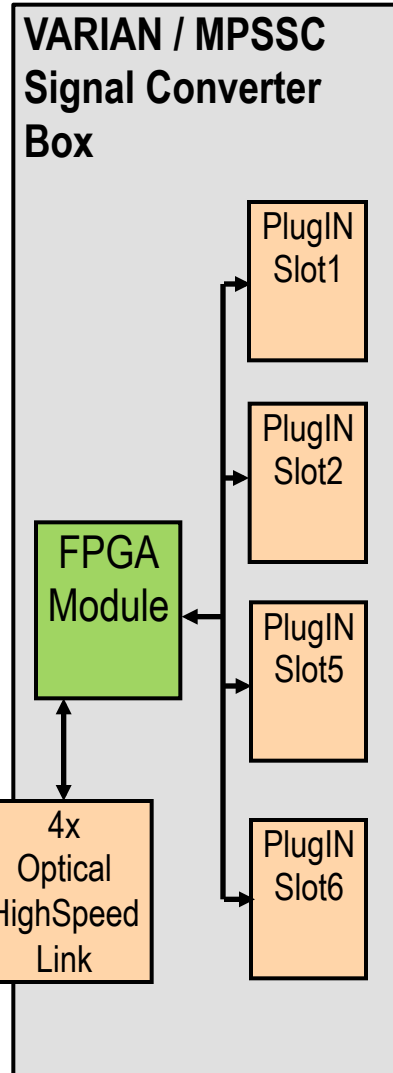

Gantry 3 Patient Safety System Architecture

Color Coding of Components

Location	Emergency Point
	VMS System
	Control Room
	CSI Public Adapter
	Others

Color Coding of Signals

Priority signals	Emergency Point
Signals before Priorities	VMS System
Signals related to mode selection	Control Room
Signals of the Emergency-Off button	CSI Public Adapter
Mastering-related signals	Others
Optical signals	Emergency Point
RF/High-Speed Optical Links	VMS System

IP IDs

CSI Public Adapter	Non-activated IP
MPSG (Control Panel)	Active
Where is stands for the number of the individual IP as shown in the drawing	

Document

PSI Cyber to Proscan Therapy	CS-ID	2018/05
DR. S.G. DINA M. BUCHI	Revision	1.0
	Status	Final

Signatures

Author	System	Doc.	System
			Version Medical Systems

MPSG Signal Convention

Area 0	Control 1
Area 1	Control 2
Area 2	Control 3
Area 3	Control 4
Area 4	Control 5

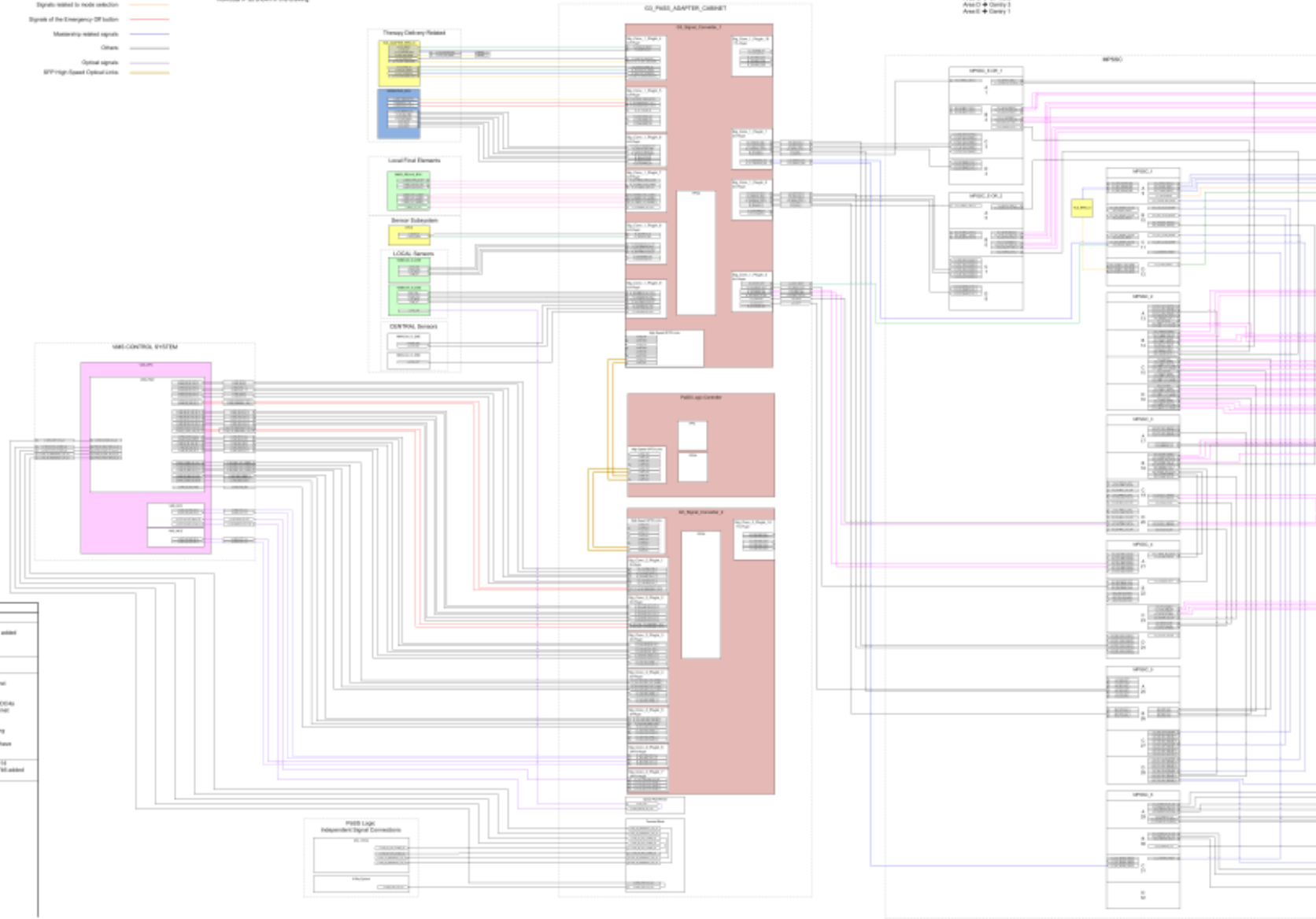

Rev. #	Date	Status	Comment
0.1	10.10.2014	Draft	Initial Revision
0.2	03.10.2014	Draft	<ul style="list-style-type: none"> Signal wiring errors corrected add signal indication for VMS signals added VMS for alarm signal removed PSI Operating box added (Equipment frame box) Utility system added PSM Signal names added
0.3	10.10.2014	Draft	
0.4	10.10.2014	Draft	<ul style="list-style-type: none"> Emergency-Off signal from operator box and feedback signal in VMS added add VMS signals from CSI-DRM removed add VMS signal from connection from MESSINA IC-DRM via optical IP to PSI-Multiplexer cabinet add VMS signals to MPSG connection changed VMS-ack systems added Signal in SignalCommitter emergency according to Page 10 VMS signals connected to SignalCommitter have been updated into a control signals CS-ID updated added
0.5	16.10.2014	Draft	<ul style="list-style-type: none"> Document reviewed by PSI 10.10.2014 Final review according CS-ID 2017/01 added Project names added
1.0	25.10.2014	Final	Document signed by PSI



If you think
proton therapy controls
is complicated...

Union Pacific «Big Boy» 1941

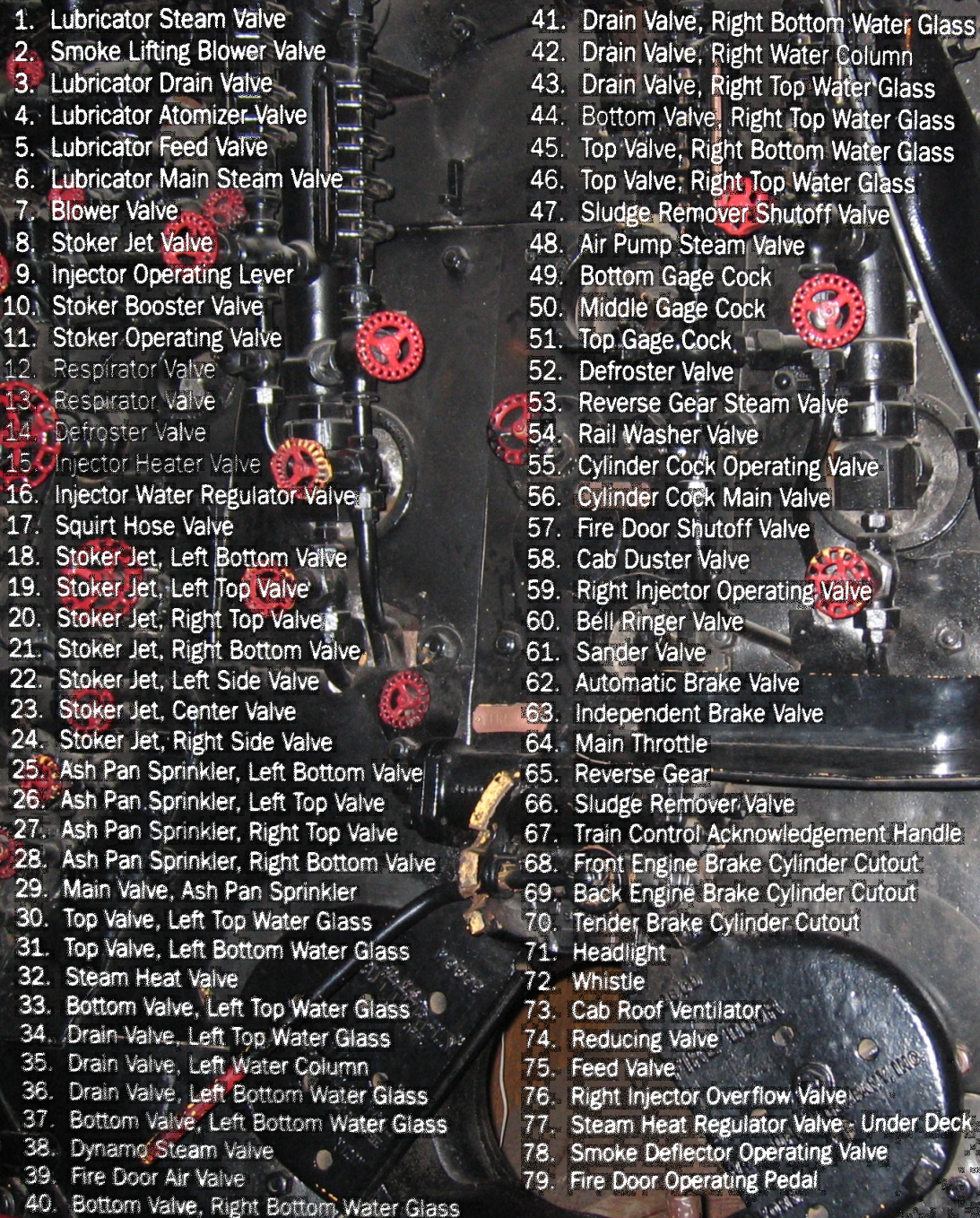

- 
1. Lubricator Steam Valve
 2. Smoke Lifting Blower Valve
 3. Lubricator Drain Valve
 4. Lubricator Atomizer Valve
 5. Lubricator Feed Valve
 6. Lubricator Main Steam Valve
 7. Blower Valve
 8. Stoker Jet Valve
 9. Injector Operating Lever
 10. Stoker Booster Valve
 11. Stoker Operating Valve
 12. Respirator Valve
 13. Respirator Valve
 14. Defroster Valve
 15. Injector Heater Valve
 16. Injector Water Regulator Valve
 17. Squirt Hose Valve
 18. Stoker Jet, Left Bottom Valve
 19. Stoker Jet, Left Top Valve
 20. Stoker Jet, Right Top Valve
 21. Stoker Jet, Right Bottom Valve
 22. Stoker Jet, Left Side Valve
 23. Stoker Jet, Center Valve
 24. Stoker Jet, Right Side Valve
 25. Ash Pan Sprinkler, Left Bottom Valve
 26. Ash Pan Sprinkler, Left Top Valve
 27. Ash Pan Sprinkler, Right Top Valve
 28. Ash Pan Sprinkler, Right Bottom Valve
 29. Main Valve, Ash Pan Sprinkler
 30. Top Valve, Left Top Water Glass
 31. Top Valve, Left Bottom Water Glass
 32. Steam Heat Valve
 33. Bottom Valve, Left Top Water Glass
 34. Drain Valve, Left Top Water Glass
 35. Drain Valve, Left Water Column
 36. Drain Valve, Left Bottom Water Glass
 37. Bottom Valve, Left Bottom Water Glass
 38. Dynamo Steam Valve
 39. Fire Door Air Valve
 40. Bottom Valve, Right Bottom Water Glass
 41. Drain Valve, Right Bottom Water Glass
 42. Drain Valve, Right Water Column
 43. Drain Valve, Right Top Water Glass
 44. Bottom Valve, Right Top Water Glass
 45. Top Valve, Right Bottom Water Glass
 46. Top Valve, Right Top Water Glass
 47. Sludge Remover Shutoff Valve
 48. Air Pump Steam Valve
 49. Bottom Gage Cock
 50. Middle Gage Cock
 51. Top Gage Cock
 52. Defroster Valve
 53. Reverse Gear Steam Valve
 54. Rail Washer Valve
 55. Cylinder Cock Operating Valve
 56. Cylinder Cock Main Valve
 57. Fire Door Shutoff Valve
 58. Cab Duster Valve
 59. Right Injector Operating Valve
 60. Bell Ringer Valve
 61. Sander Valve
 62. Automatic Brake Valve
 63. Independent Brake Valve
 64. Main Throttle
 65. Reverse Gear
 66. Sludge Remover Valve
 67. Train Control Acknowledgement Handle
 68. Front Engine Brake Cylinder Cutout
 69. Back Engine Brake Cylinder Cutout
 70. Tender Brake Cylinder Cutout
 71. Headlight
 72. Whistle
 73. Cab Roof Ventilator
 74. Reducing Valve
 75. Feed Valve
 76. Right Injector Overflow Valve
 77. Steam Heat Regulator Valve - Under Deck
 78. Smoke Deflector Operating Valve
 79. Fire Door Operating Pedal