



Intensity Limitations in Particle Beams
CERN, Geneva, Switzerland
2 - 11 November, 2015

High Brightness Photo-Injectors

Enrica Chiadroni
INFN - LNF

Outline

- Definition of **Brightness**
- **Why** High Brightness Electron Beams (HBEs)
- How to generate and preserve HBEs
- Definition of Electron Injector
 - **Photo-Injector Theory**
 - Photo-cathode emission
 - RF gun
 - Emittance compensation (Ferrario's lecture)
 - Injection into the linac
 - Acceleration and compression
- **Virtual Operation** of a High Brightness Photo-Injector to drive a Free-Electron Laser

Brightness

1939 von Borries and Ruska (Nobel prize in Physics in 1986 for the invention of the Electron Microscope) introduced the so called beam brightness (“Richstrahlwert”) defined as:

$$B_{micr} = \frac{I}{A\Omega} \approx \text{constant}$$

The smaller the spot the larger the divergence.

The brightness defines then the quality of the source and determines the kind of experiments

$$Brightness = \frac{\text{Contrast}}{\underbrace{\pi r^2}_{\text{Spatial resolution}} \underbrace{\pi \alpha^2}_{\text{Coherence}} \underbrace{\Delta t}_{\text{Time resolution}}}$$

Contrast
Ne

6D Beam Brightness

The meaningful figure of merit used to describe electron sources should be the 6D beam brightness defined as

$$B_{6D} = \frac{Ne}{V_{6D}}$$

where V_{6D} is the volume occupied by the beam in the 6D phase space (x, p_x, y, p_y, z, p_z)

$$V_{6D} = \int \psi(x, p_x, y, p_y, z, p_z) dx dp_x dy dp_y z dp_z$$

which is proportional to the product of the three normalized emittances

$$B_{6D} \propto \frac{Ne}{\epsilon_{nx} \epsilon_{ny} \epsilon_{nz}}$$

The 6D phase space of non-interacting particles in a conservative dynamical system is invariant -> **Liouville theorem**

As long as the particle dynamics in the beamline elements (transport optics, accelerating sections) can be described by Hamiltonian functions (no binary collisions, stochastic processes, etc.), the phase space density will stay constant throughout the accelerator

Definition of Brightness

$$B_{6D} \propto \frac{Ne}{\epsilon_{nx}\epsilon_{ny}\sigma_t\sigma_\gamma}$$

High brightness means a large number of **quasi-“monochromatic” electrons**, concentrated in very **short bunches**, with small transverse size and divergence, i.e. **small transverse emittance**. For a fixed charge/bunch it translates in preserving the transverse emittance and increasing the final current by reducing the bunch length.

In numbers: $N \approx 10^9$, $\sigma_\gamma \approx 10^{-3}$, $\epsilon_n \approx 1 \text{ mm mrad}$, $\sigma_t \lesssim 1 \text{ ps}$

$$B_{6D} \approx 10^{15} \frac{A}{m^2}$$

Possible sources of rms emittance growth

Non-linear space charge forces

Non linear forces from electromagnetic components

Synchrotron radiation emission (in magnetic compressors)

Why High Brightness Electron Beams

Short wavelength (X-ray) Free-Electron Lasers

- Free-Electron Lasers (FELs) have supported photo-injector development

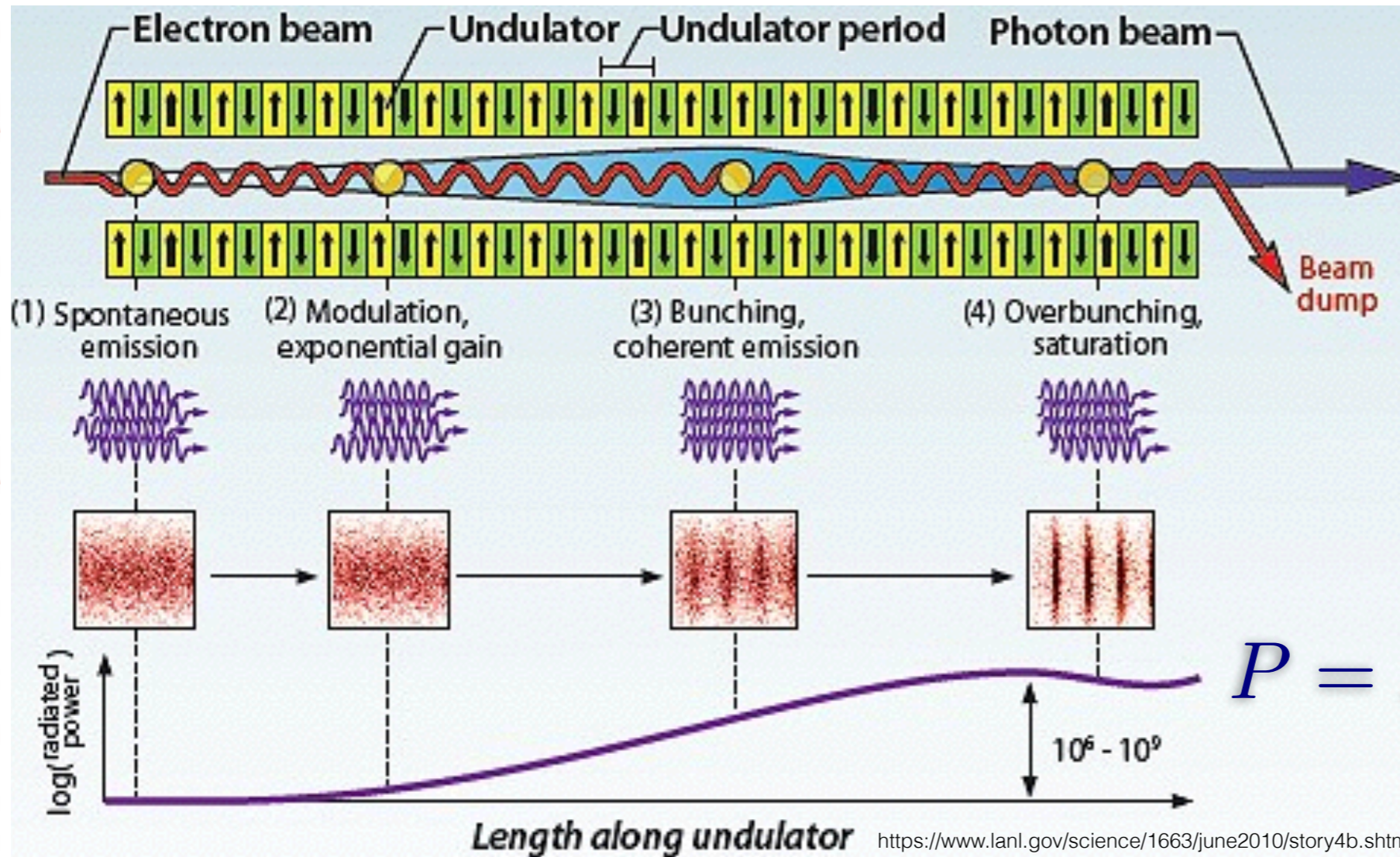

Resonance condition

$$\lambda_r = \frac{\lambda_u}{2\gamma^2} \left(1 + \frac{K^2}{2} + \gamma^2 \vartheta^2 \right)$$

$$K = \frac{eB_0\lambda_u}{2\pi mc}$$

K defines the maximum angle of the emitted angle with respect to the axis

Gain length

$$L_g = \frac{\lambda_u}{4\sqrt{3}\pi\rho}$$

Pierce parameter

$$\rho = \frac{1}{2\gamma} \left[\frac{I}{I_A} \left(\frac{\lambda_u K [JJ]}{\sqrt{8\pi\sigma_x}} \right)^2 \right]^{1/3}$$



$$L_g \propto B_{n,6D}^{-\frac{1}{3}}$$

Why High Brightness Electron Beams

Short wavelength (X-ray) Free-Electron Lasers

The 6-D brightness of the electron beam plays a significant role not only on the gain and efficiency of the FEL process, but also on its spectral characteristics

Resonance condition

$$\lambda_r = \frac{\lambda_u}{2\gamma^2} \left(1 + \frac{K^2}{2} + \gamma^2 \vartheta^2 \right)$$

$$\lambda_u \approx cm$$

$$K \approx 1$$

$$\gamma \approx 10^3 - 10^4$$

In X-ray FELs, the matching condition for transverse emittance drives towards small normalized emittances

$$\varepsilon_n < \gamma \frac{\lambda_r}{4\pi} \approx 1 \text{ mm mrad}$$

In X-ray FELs, the matching condition for the energy spread requires

$$\sigma_\delta < \rho \approx 10^{-3}$$

$$\frac{\Delta\omega}{\omega} \approx \frac{1}{N_u} \sim \rho$$

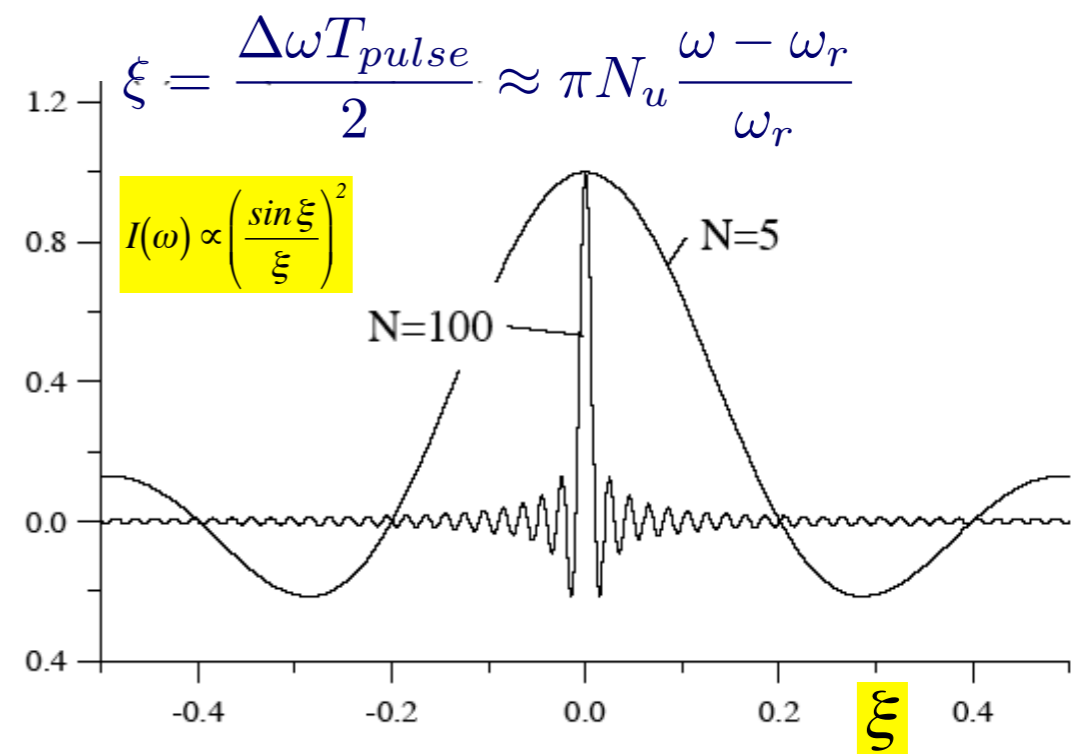

Why High Brightness Electron Beams

High average power FELs, Energy Recovery Linac, ...

- High average power FELs (soft X-rays and IR), Energy Recovery Linac (ERL), linac-based THz radiation sources require
 - mA average currents
 - > MHz repetition rate
 - Low emittance
- In addition THz sources require ultra-short, $\sim < 100$ fs, electron beams in order to extend the frequency spectrum in the THz range

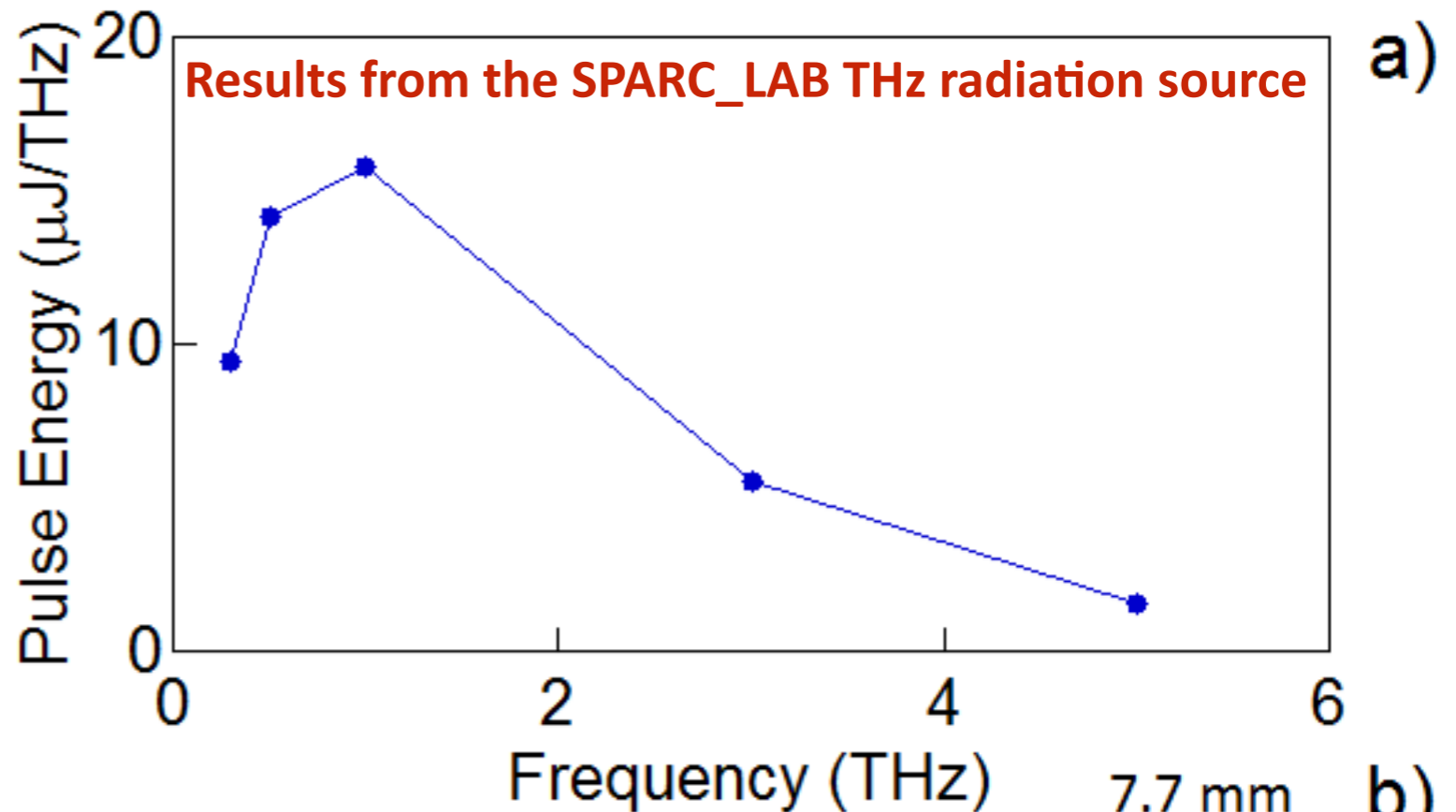

Spatial distribution of coherent transition radiation as produced by a 500 pC, 100 fs rms bunch duration

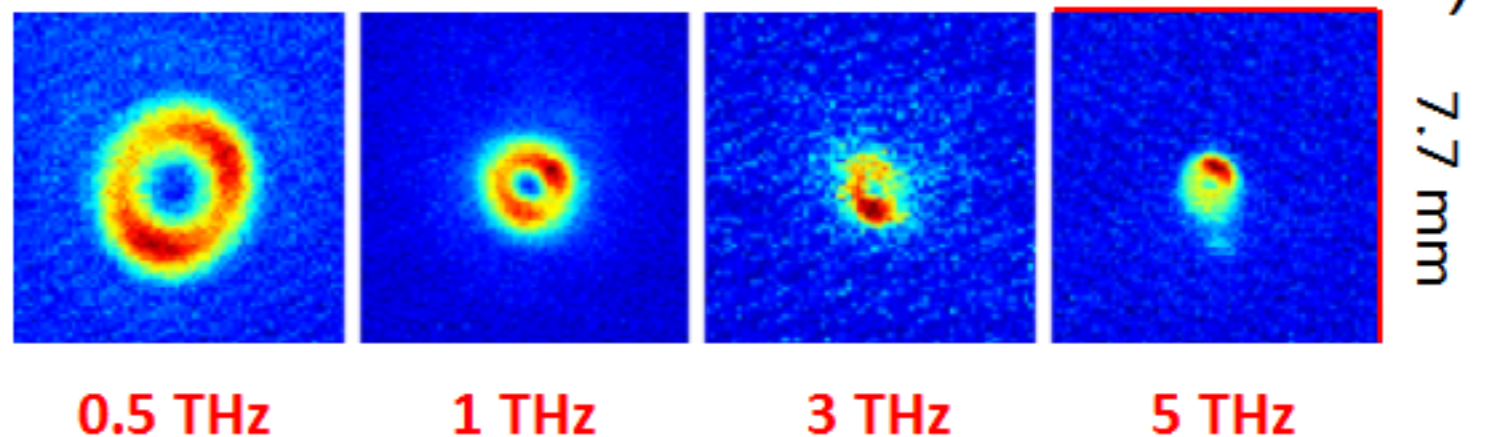

Why High Brightness Electron Beams

Inverse Compton Scattering Sources

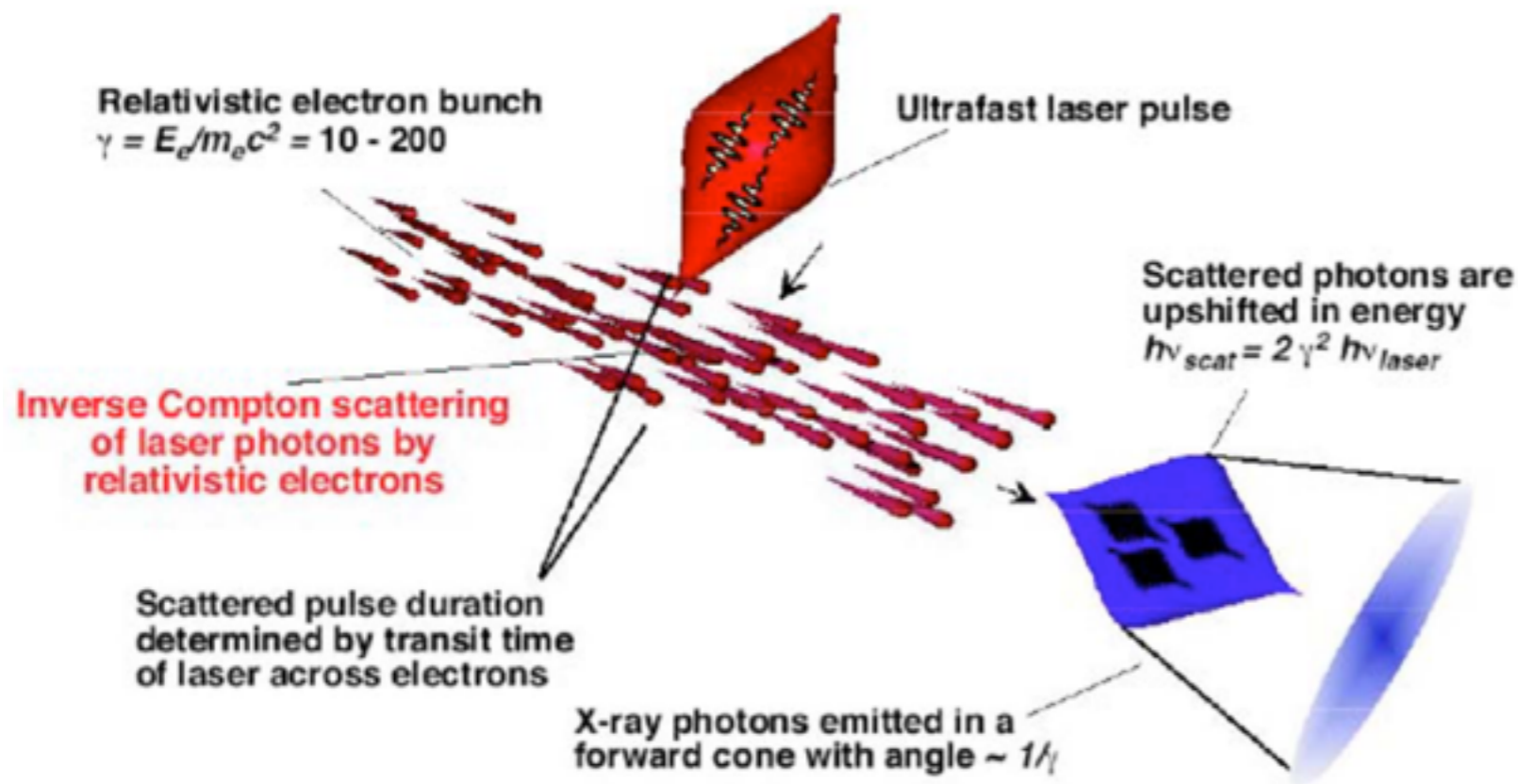

- High charge to increase the X-ray yield
- Short bunches for ultra fast X-ray pulses
- Narrow bandwidth
 - Small emittance to allow focusing on micron spot size
 - Low energy spread to reduce the radiation bandwidth

$$\frac{\Delta\nu_\gamma}{\nu_\gamma} \cong \sqrt{(\gamma\vartheta)_{rms}^4 + 4\left(\frac{\Delta\gamma}{\gamma}\right)^2 + \left(\frac{\sqrt{2}\epsilon_n}{\sigma_x}\right)^4 + \left(\frac{\Delta\nu}{\nu}\right)^2 + \left(\frac{M^2\lambda_L}{2\pi w_0}\right)^4 + \left(\frac{a_{0p}^2/3}{1+a_{0p}^2/2}\right)^2}$$

$\gamma\vartheta =$ normalized collection angle

electron beam

laser

Optimized Bandwidth $\cong 2(\epsilon_n / \sigma_x)^2$

Why High Brightness Electron Beams

Plasma-based Accelerators

RF photo-injectors are needed as drivers for electron beam driven plasma wakefield accelerators

J. Rosenzweig et al., Phys. Rev. Lett. 61, 98 (1988); Blumenfeld, Nature 445, 741 (2007); M. Litos et al., Nature 515, 92 (2014)

- The high-gradient wakefield is driven by an intense, high-energy charged particle beam as it passes through the plasma

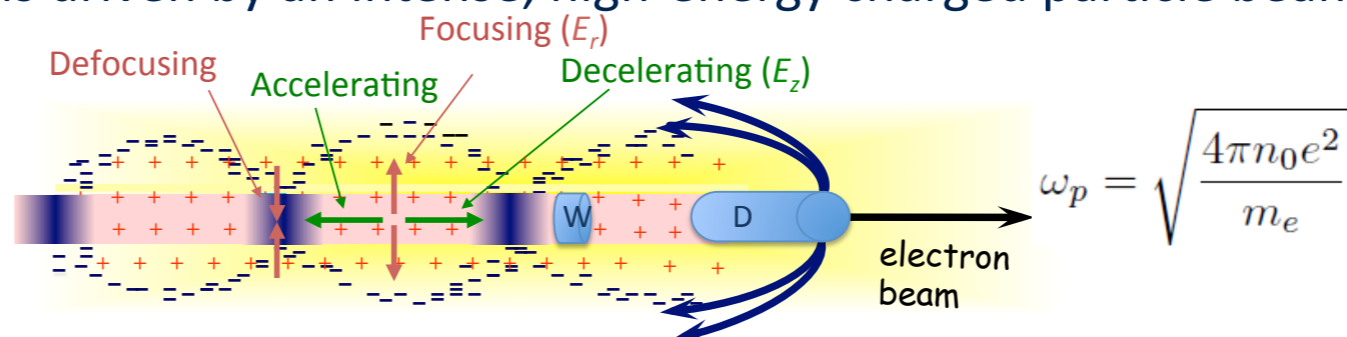

- The space-charge of the electron bunch blows out the plasma electrons which rush back in and overshoot setting up a plasma oscillation with plasma frequency ω_p , which depends on plasma density n_0

In numbers: $N = 2 \times 10^{10}$ $\sigma_z \cong 200 \mu\text{m}$

- Plasma e^- are expelled by space charge forces
 - energy loss + focusing
- Plasma e^- rush back on axis
 - energy gain

$$E_z \propto \left(\frac{N}{\sigma_z} \right)^2 N_T \gtrsim \text{GV/m}$$

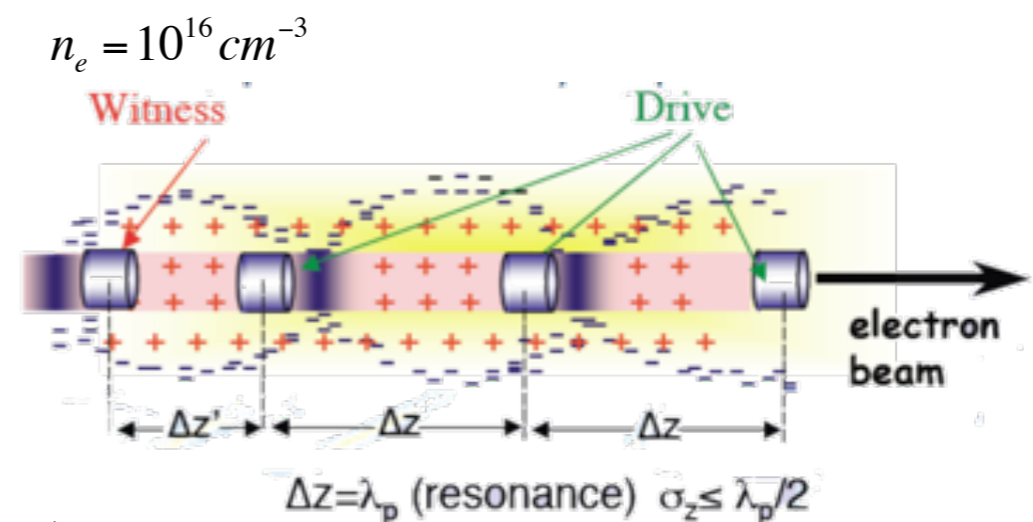

Injectors: a bit of history

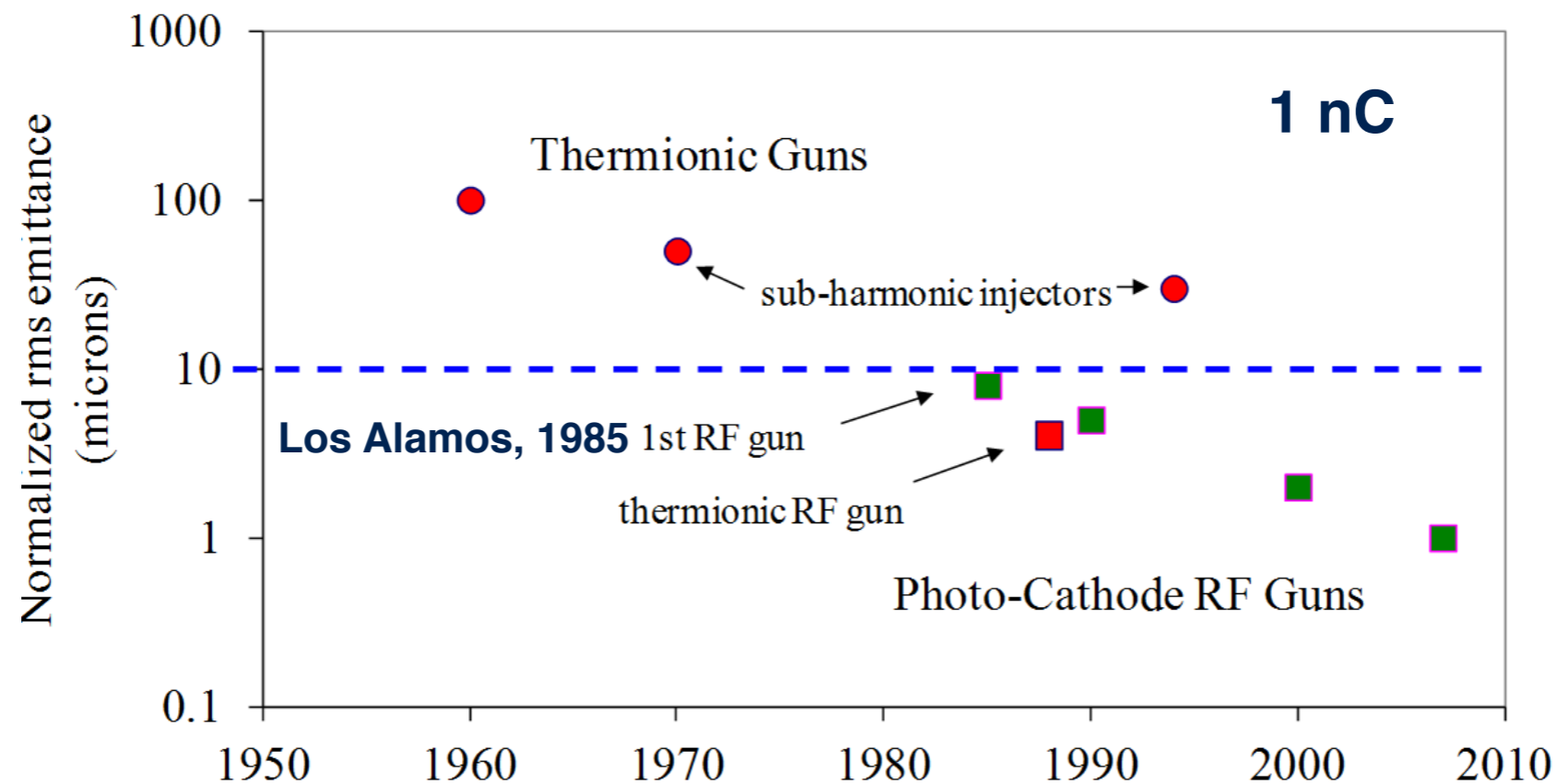

Dowell, Rao, *An Engineering Guide To Photoinjectors*,

The **need for fast and precise control of the electron pulse shape** for better beam quality led to the replacement of thermionic gun with **photocathode RF guns** because of the impressive reduction in transverse emittance (10 times and more), promoted by the **ability to shape drive laser pulses and rapidly accelerate electrons from rest to relativistic energies**

Elements of an Electron Injector

- An **electron injector** is the **first part of the accelerating chain**
 - The **electron beam generated at rest energy** is accelerated and **guided up to energies** where space charge force effects are negligible and under control, therefore **its evolution is not space charge dominated anymore**
 - Space charge forces scale inversely with the square of the beam energy
- Space charge forces influence the beam dynamics and are one the main performance limitations in high brightness electron injectors

Particle source

- Photo-electric cathode
- Normal Conducting RF gun

Beam conditioning

- Emittance compensation
- RF compression

Acceleration

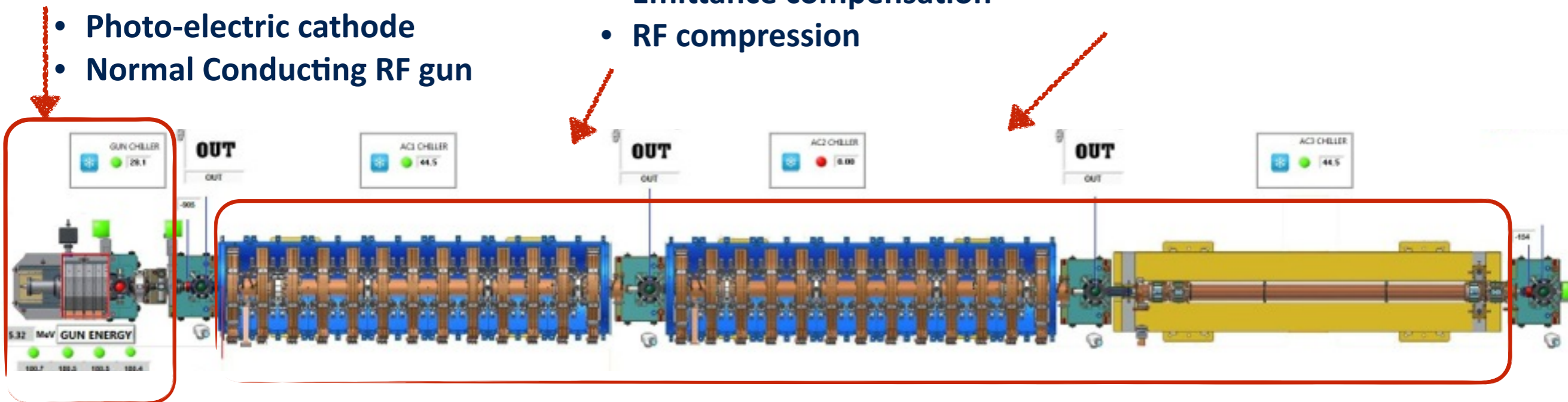

High Brightness Photo-injector Components

A **photo-injector** consists of a **laser generated electron source** followed by an electron beam optical system which preserves and matches the beam into a high-energy accelerator

- **Drive laser**
 - To gate the emission of electrons from the cathode
- **Photocathode**
 - Releases picosecond electron bunches when irradiated with laser pulses
- **Electron Gun**
 - Accelerates electrons from the rest
 - The high electric fields produced by rf guns are necessary both to extract the high currents and to minimize the effects of space charge on emittance growth while the bunch is accelerated to relativistic energies where the space-charge forces vanish
 - Acts as strong defocusing lens => **Solenoid magnet**
- **Accelerating system**
 - to mitigate the space charge emittance growth

Typical High Brightness Photo-injector Layout

A typical photocathode RF system depicts a $1\frac{1}{2}$ -cell gun with a cathode in the $\frac{1}{2}$ cavity being illuminated by a laser pulse train. At the exit of the gun is a solenoid which focuses the divergent beam from the gun and compensates for space charge emittance. The drive laser is mode-locked to the RF master oscillator which also provides the RF drive to the klystron.

RF frequencies

1.3 GHz: L-band
2.856 GHz: S-band
5.6 GHz: C-band
11- 17 GHz X-band

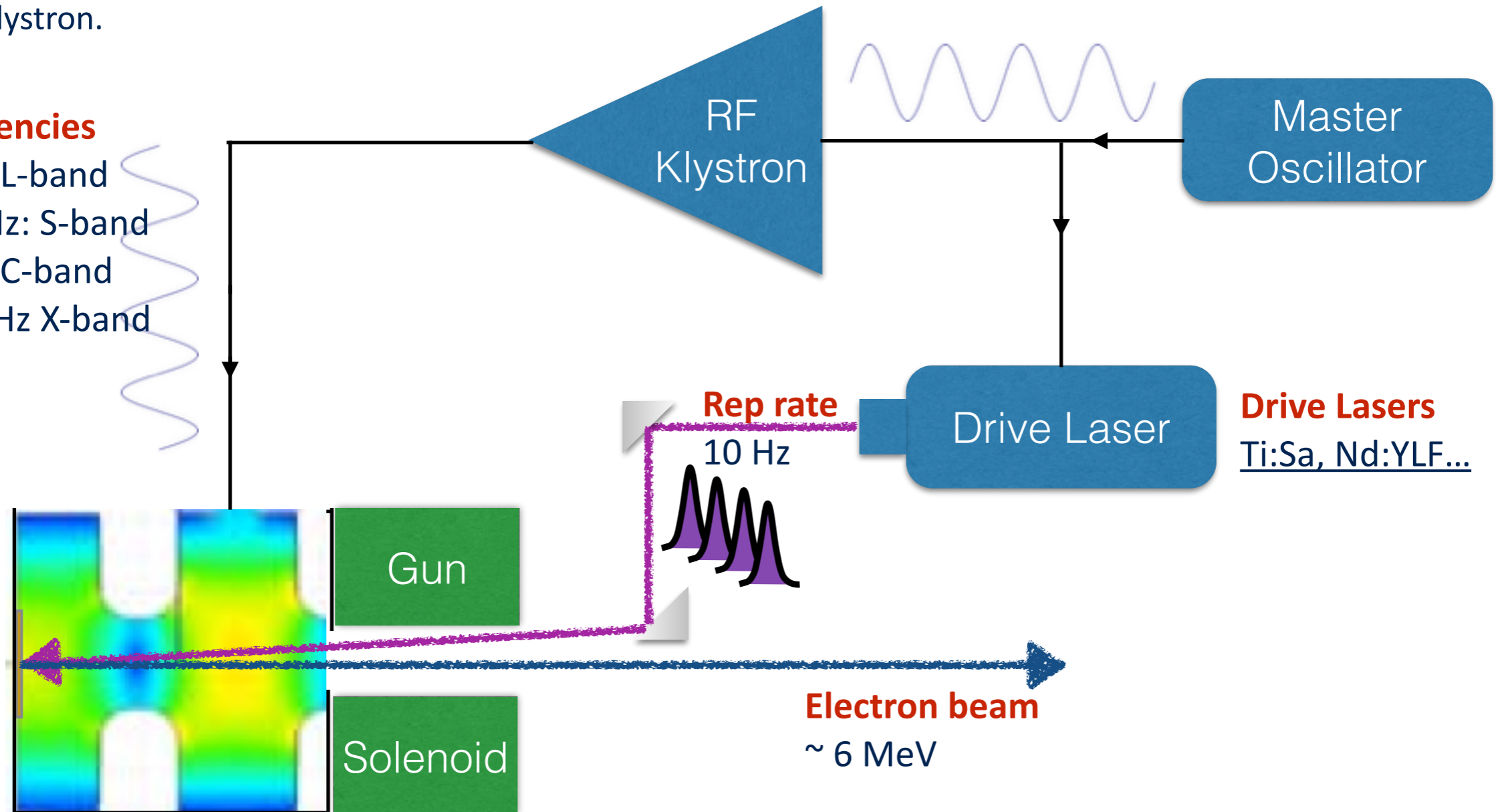

Photo-cathodes

Metal: Cu, Mg, ...

Semi-conductor: CsTe, CsKSb, ...

The **ideal cathode** should have **low intrinsic emittance**, **high quantum efficiency**, **long life-time**, **uniform emission** and should allow for low energy spread, high current density beams and full control of bunch distribution => **fast response**

Fields near the cathode surface

Electric potential energy

$$e\Phi_{tot} = e\Phi_{work} - \frac{e^2}{16\pi\epsilon_0 x} - eE_0x$$

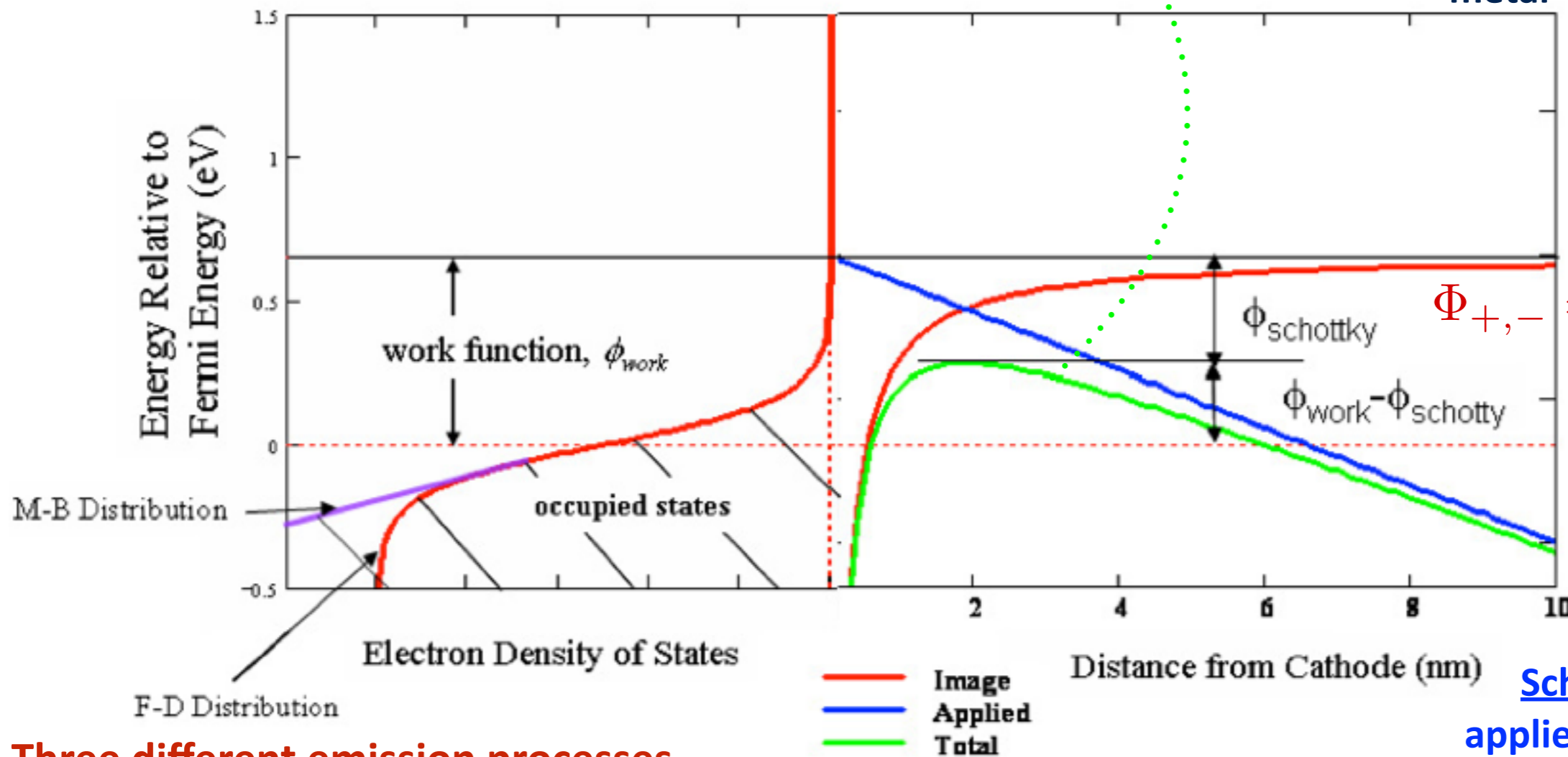
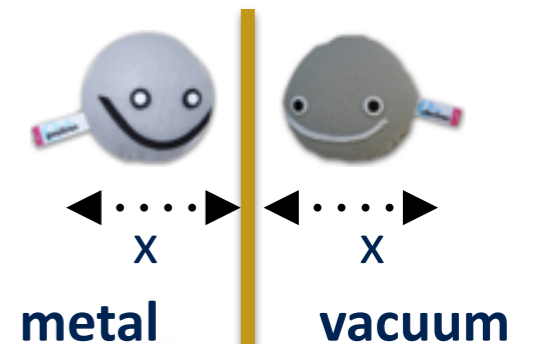

Image charge

$$\Phi_{+,-} = -\frac{e^2}{16\pi\epsilon_0 x}$$

Schottky effect
applied external field
lower the barrier

$$\Phi_{sh} = -eE_0x$$

Three different emission processes

1. Thermionic emission → Require electrons with energies greater than the work function to escape the barrier

2. Photo-electric emission

3. Field emission →

Consequence of the Schottky effect. Electrons tunneling the barrier. Very fast dependence on applied field => **DARK CURRENT**

Photo-electric Emission

Spicer's three-step photoemission model

1. Photon energy absorption by electron

- The optical skin depth depends on photon wavelength (~ 14 nm for UV light on Cu)
- reflectivity and absorption as the photons travel into the cathode

2. electron transport to the surface

- electron-electron scattering
- electron-phonon scattering
- angular cone of escaping electrons

3. electron escape through the barrier

- Schottky effect and abrupt change in electron angle across the metal-vacuum interface
- classical escape over the barrier due to the applied field

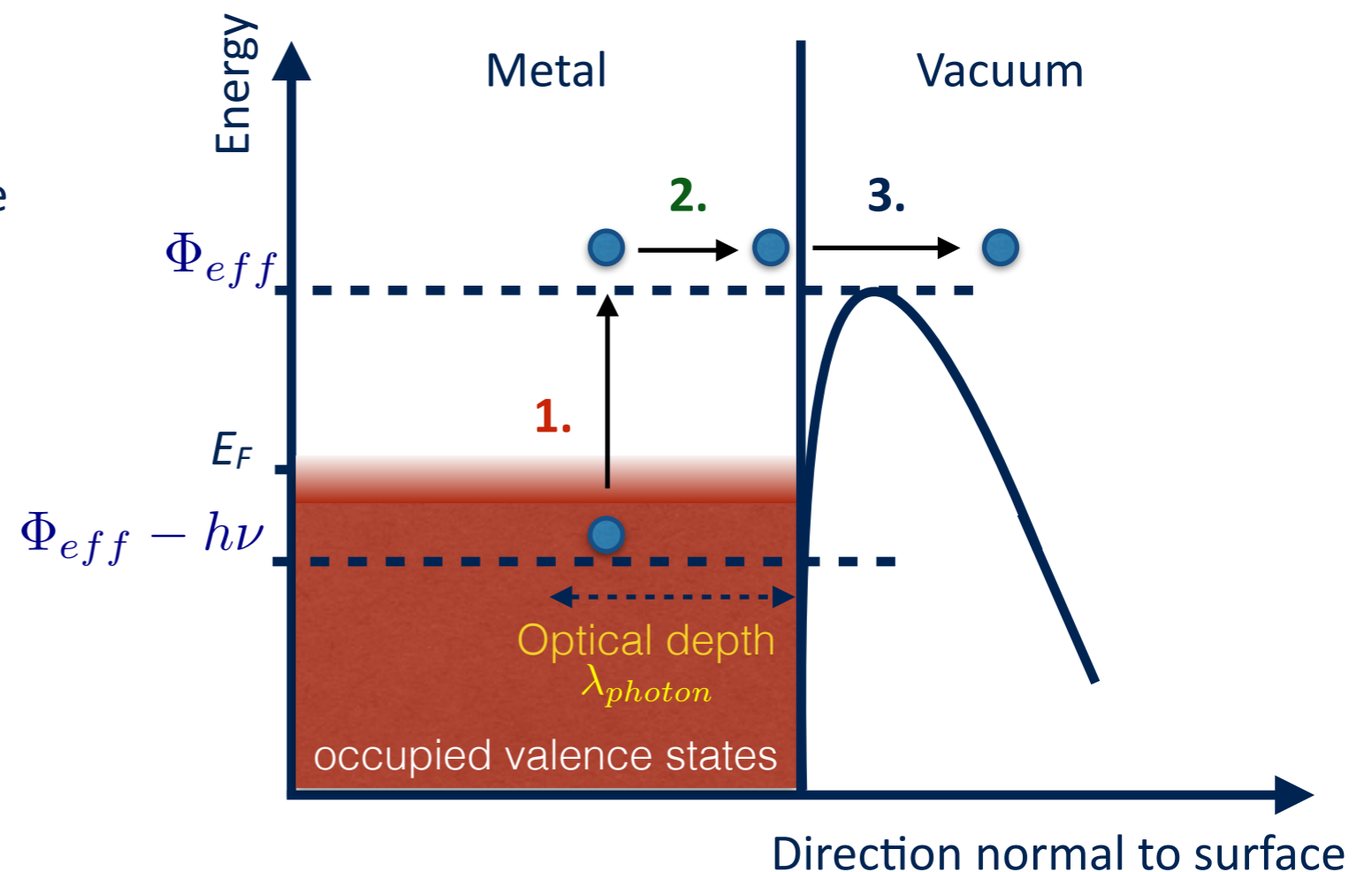

Quantum Efficiency

Combining the three steps together, the quantum efficiency, QE, can be expressed in terms of the probabilities for these processes to occur

1. absorption of the photon with energy $\hbar\omega$
2. migration including e-e scattering to the surface
3. escape for electrons with kinematics above the barrier

$$QE(\omega) = [1 - R(\omega)] F_{e-e}(\omega) \frac{\int_{E_F + \Phi_{eff} - \hbar\omega}^{E_F} dE \int_{-1}^1 \sqrt{\frac{E_F + \Phi_{eff}}{E + \hbar\omega}} d(\cos \vartheta) \int_0^{2\pi} d\phi}{\int_{E_F - \hbar\omega}^{E_F} dE \int_{-1}^1 d(\cos \vartheta) \int_0^{2\pi} d\phi}$$



Probability of a photon to be absorbed by the metal

$R(\omega) \sim 40\%$ for metals

$1 - R(\omega) \sim 0.6$



Probability that an electron reaches the surface without scattering with another electron

$F_{e-e}(\omega) \sim 0.2$



Probability that an electron will be excited into a state with sufficient perpendicular momentum to escape the material

occupied states with enough energy to escape ~ 0.04

electrons with angle within the max angle ~ 0.01

azimuthally isotropic emission ~ 1

$$QE(\text{Cu}) \sim 0.6 * 0.2 * 0.04 * 0.01 * 1 \sim 5 * 10^{-5}$$

Intrinsic Emittance

The total energy inside the cathode after absorption of the photon is $E + \hbar\omega$, therefore the total momentum inside and outside is

$$p_{total,in} = \sqrt{2m(E + \hbar\omega)} \quad p_{total,out} = \sqrt{2m(E + \hbar\omega - \Phi_{eff} - E_F)}$$

The usual definition of rms emittance is

$$\epsilon_{n,x} = \beta\gamma \sqrt{\langle x^2 \rangle \langle x'^2 \rangle - \langle xx' \rangle^2} = 0, \text{ no correlation between angle and position of electrons out of the cathode}$$

σ_x transverse beam size determined by the size of the source, i.e. laser pulse

$$\epsilon_{n,x} = \sigma_x \frac{\sqrt{\langle p_x^2 \rangle}}{mc}$$

p_x transverse momentum determined by the emission process

$$\langle p_x^2 \rangle = \frac{\int \int \int p_x^2 g(E, \vartheta, \phi) dE d(\cos \vartheta) d\phi}{\int \int \int g(E, \vartheta, \phi) dE d(\cos \vartheta) d\phi}$$

$$g(E, \vartheta, \phi) = [1 - f_{FD}(E + \hbar\omega)] f_{FD}(E)$$

electron distribution function which depends on the emission process determined by the emission process

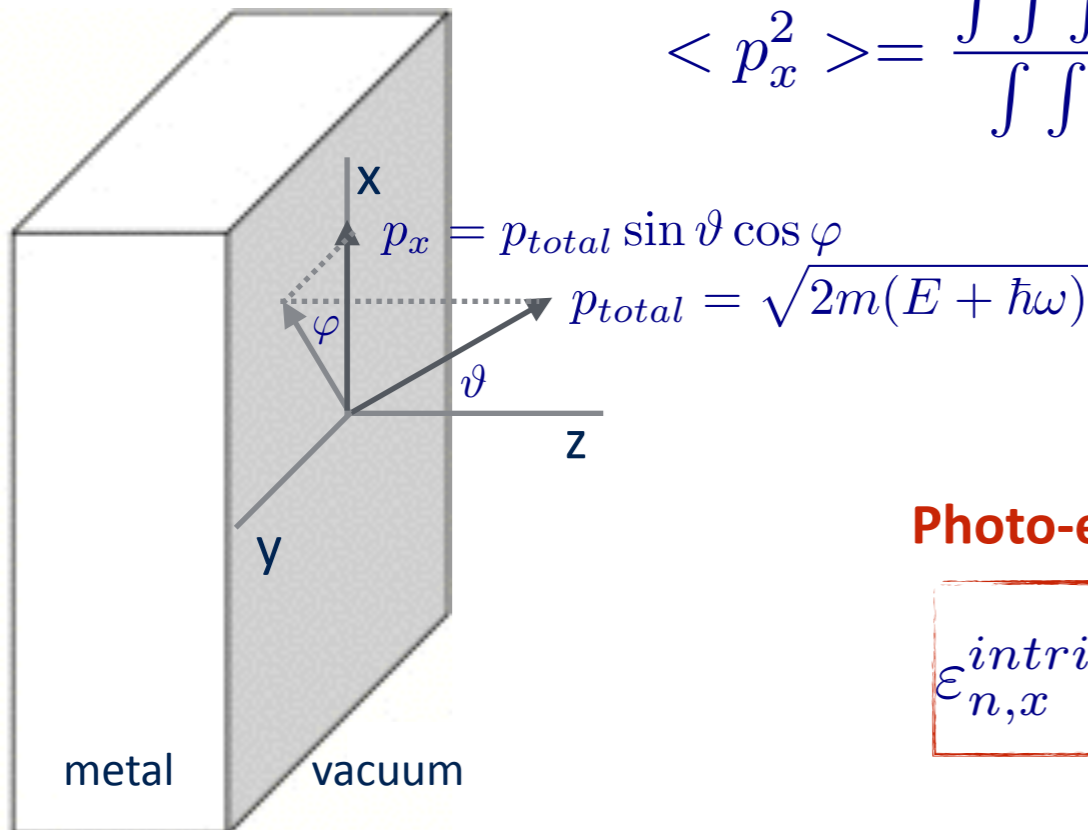

Photo-electric normalized emittance

$$\epsilon_{n,x}^{intrinsic} = \sigma_x \sqrt{\frac{\hbar\omega - \Phi_{eff}}{3mc^2}}$$

Cu cathode

$$\approx 0.4 \text{ mm mrad/mm}$$

Space Charge Effects

- As emitted particles come out from the cathode they create their own electric field
- This field in the beam tail is opposed to the external field, growing with the extracted charge
- The effective total potential is distorted by this field
- The potential distortion creates asymmetries in the electron beam (tails) and set a **maximum extractable current in the steady state regime**

- **Child-Langmuir law**

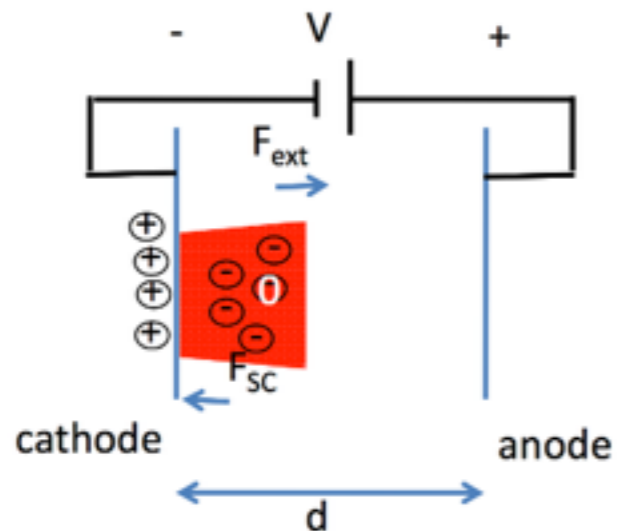

The Child-Langmuir law expresses how the steady state current varies with both the gap distance and the bias potential of the parallel plates

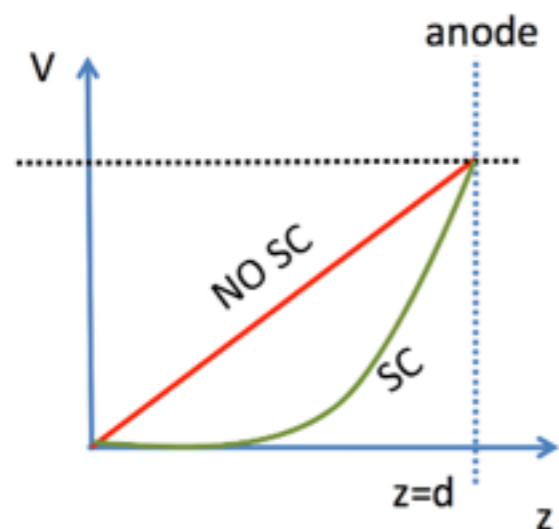

$$\frac{d^2 \Phi}{dz^2} = -\frac{\rho}{\epsilon_0}$$

Poisson equation

$$j(z) = \rho v(z)$$

Conservation of flux

$$e\Phi = \frac{mv^2}{2} - \frac{mv_0^2}{2}$$

Conservation of energy

Child-Langmuir Law

The maximum current density in an electron source is typically given by the Child-Langmuir law:

$$j_{CL,1D} = \frac{4\epsilon_0}{9} \sqrt{\frac{2e}{m}} \frac{V_0^{3/2}}{d^2}$$

Assumptions

- **infinitely wide beam** in the transverse dimensions (1D approximation)
- the **beam completely fills the accelerating gap** so that a steady state solution can be found
- **relativistic effects** can be **neglected**

BUT

In state-of-art photo-injectors

- the initial **electron beam pulse length** is always much **smaller than the accelerating gap**
- the **laser spot size** on the cathode tends to be small (**sub-mm**) to decrease the cathode emittance contribution

The 1D Child-Langmuir formula is not valid anymore

Space Charge Limit

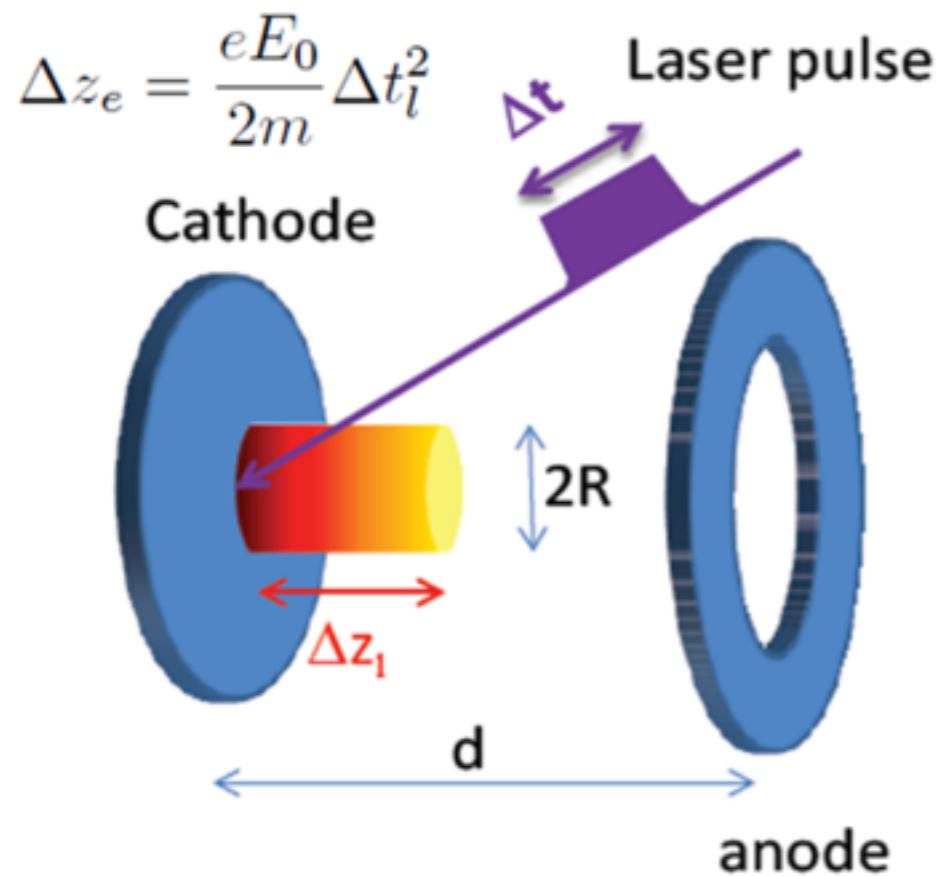

2 cases:

$R > \Delta z_e$ pancake aspect ratio

$R < \Delta z_e$ cigar aspect ratio

Pancake aspect ratio case

Maximum surface charge density set by the cathode extraction field.

$$\frac{Q}{\pi R^2} < \epsilon_0 E_0$$

The space charge limit (SCL) is reached when the space charge field equals the applied, external field, E_0 , and electron emission saturates

Cigar aspect ratio case

Only a small part of the beam contributes to the space charge field and higher charge can be extracted.

$$Q = J_{CL} \pi R^2 \propto \frac{V^{\frac{3}{2}}}{d^2} R^2 \propto (E_0 R)^{\frac{3}{2}}$$

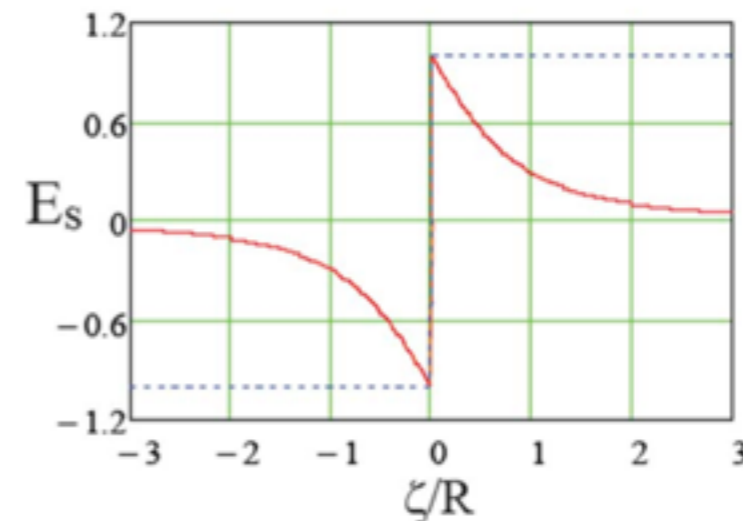

— Finite transverse dimensions
 - - - Infinite transverse dimensions

Courtesy of P. Musumeci

Space Charge Limit Emittance

The SCL sets a minimum value for the beam emittance, once the applied field (RF field) value and the requested charge are known.

For a cylindrical uniformly filled beam with radius R , the rms size is

$$\sigma_x = \frac{R}{2} = \sqrt{\frac{Q_{bunch}}{4\pi\epsilon_0 E_a}}$$

Substituting the normalized divergence for photo-electric emission, $\sigma_{x'}$, the normalized cathode emittance results in the SCL photoelectric emittance

$$\epsilon_{photo}^{SCL} = \sqrt{\frac{Q_{bunch}(\hbar\omega - \Phi_{eff})}{4\pi\epsilon_0 mc^2 E_a}}$$

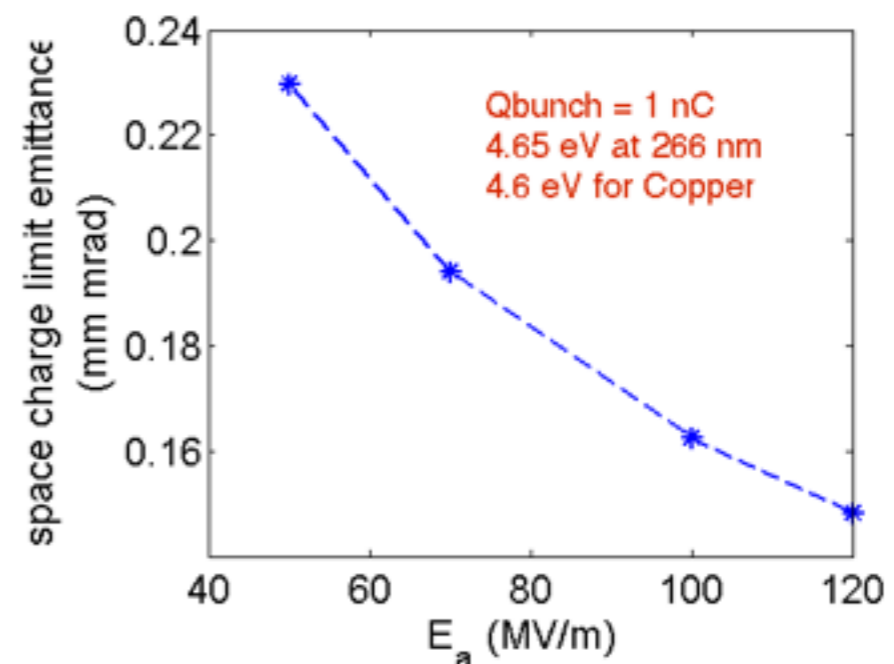
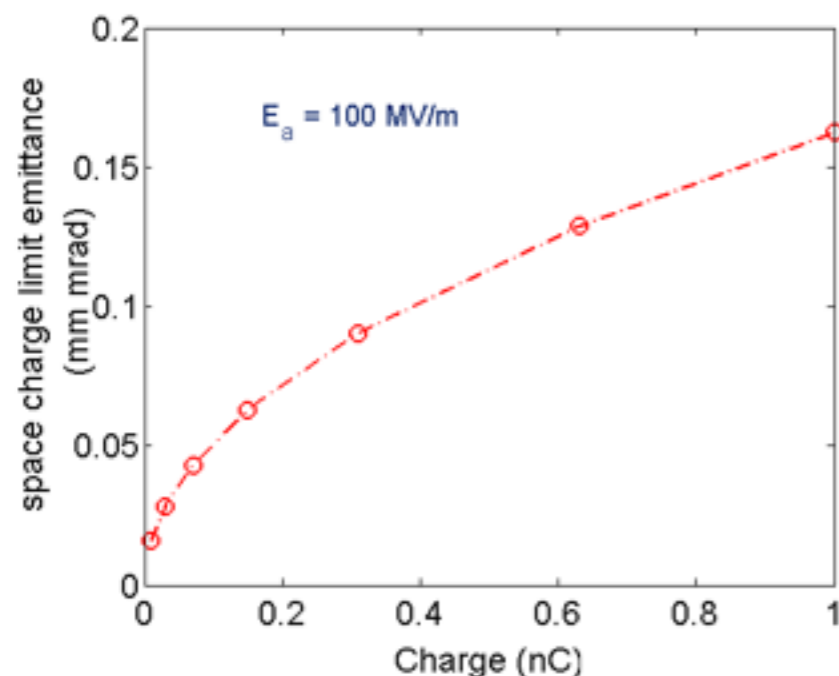

Transverse Brightness Limit

Let's remind the definition of Brightness

$$B_{6D} = \frac{N}{\varepsilon_{nx}\varepsilon_{ny}\varepsilon_{nz}}$$

In most cases the transverse and longitudinal planes can be considered decoupled, therefore a transverse brightness can be defined

$$B_{\perp} = \frac{N}{\varepsilon_{nx}\varepsilon_{ny}} \xrightarrow{Q_{bunch} = Ne} B_{\perp}^{max} = 4\pi\varepsilon_0 \frac{E_a}{e} \frac{mc^2}{\hbar\omega - \Phi_{eff}}$$

The **maximum transverse brightness does not depend on the bunch charge**, but only on the applied (RF) field, E_a , and on the emission process, through the excess energy, $\hbar\omega - \Phi_{eff}$

Under the presence of linear forces the transverse brightness is conserved during the transport

Approaching the SCL, the accelerating electric field is significantly reduced in the cathode region. Particles in the back of the beam experience lower fields and non linear potentials.

The formation of an asymmetric tail and the non linearity of involved space charge fields lower the beam brightness

RF Gun

Since we wish to accelerate electrons, the relevant modes are those with large longitudinal electric fields, E_z

$$\frac{dU}{dt} = q\vec{v} \cdot \vec{E}$$

These are the transverse magnetic (TM) modes.

The TM_{mnp} designation denotes the mode is transverse magnetic since $B_z = 0$

m mode number: azimuth angle, ϑ -dependence or rotational symmetry of the fields => $m = 0$ for all RF guns, since a beam with rotational symmetry is desired

n mode number: radial dependence of the field

p mode number: longitudinal mode of cavity => RF emittance

The full cell length for most RF guns is $\lambda/2$ and $p = 1$.

The longitudinal electric field for a pill box cavity is

$$E_z^{mnp}(r, z) = E_0 J_m(k_{mn}r) \cos(m\theta) \cos\left(\frac{2p\pi z}{\lambda}\right) e^{i\omega \frac{z}{c}}$$

Consider the pi-mode for a one and a half cell gun, therefore $m=0$, $n=0$, $p=1$, then the gun field

$$E_z = E_0 \cos(kz) \sin(\omega t + \phi_0), \quad k = \frac{\omega}{c}$$

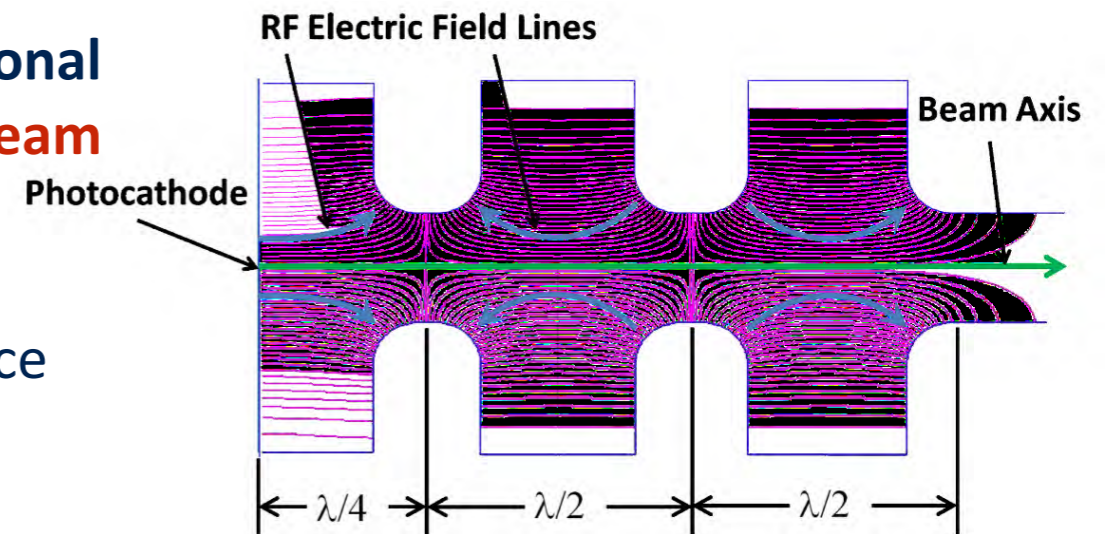

RF Gun

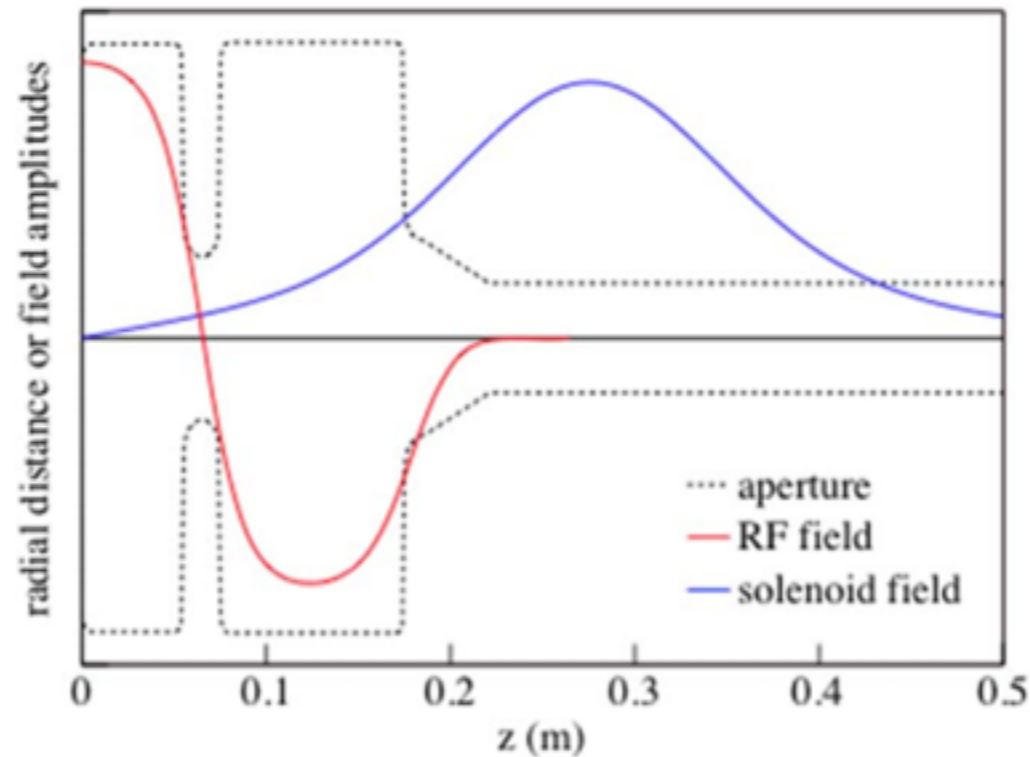

First order approximation from Maxwell equations solution for fundamental accelerating mode in a pillbox cavity.

Maxwell's equation **connect the momentum kicks of the radial electric field to the z- and t-derivative of the longitudinal electric field:**

$$E_z = E_0 \cos(kz) \sin(\omega t + \phi_0)$$

$$E_r = \frac{kr}{2} E_0 \sin(kz) \sin(\omega t + \phi_0) = -\frac{r}{2} \frac{\partial}{\partial z} E_z$$

$$B_\theta = c \frac{kr}{2} E_0 \cos(kz) \cos(\omega t + \phi_0) = \frac{r}{2c} \frac{\partial}{\partial t} E_z$$

Radial force

$$F_r = e(E_r - \beta c B_\theta)$$

Optical properties of the gun RF field

The radial momentum kick is

$$\Delta p_r = e \int E_r \frac{dz}{\beta c} = -\frac{e}{2} \int \frac{r}{\beta c} \frac{\partial E_z}{\partial z} dz$$

If we assume that the RF field is a constant step function in over the gun length, and integrate the force impulse over the position at the exit iris, the change in radial momentum is obtained

$$\Delta p_r = -\frac{eE_0}{mc^2} r \sin \phi \quad (\phi = \omega t + \phi_0 - k_z z_f)$$

Moving from cylindrical to cartesian coordinates we obtain the change in transverse momentum at the exit of the iris in terms of a kick angle

$$\Delta p_x = \beta \gamma x' = -\frac{eE_0}{2mc^2} x \sin \phi \quad \rightarrow \quad x' = -\frac{eE_0}{2\beta \gamma mc^2} x \sin \phi$$

If we define the angular kick the beam gets at the iris exit in terms of the RF gun focal length

$$x' = \frac{x}{f_{RF}} \quad \boxed{f_{RF} = -\frac{2\beta \gamma mc^2}{eE_0 \sin \phi}} \quad \text{The beam out of the gun require a focusing force}$$

In numbers: $E_0 = 110 \text{ MV/m}$, $E_{gun} = 5 \text{ MeV}$ $\phi = 30 \text{ deg}$
 $f_{RF} \cong -18 \text{ cm}$

Linear and non-linear RF emittance

Phase dependent focal strength: electrons at various longitudinal positions along the bunch length, arriving at different phases at the gun exit, experience different kicks

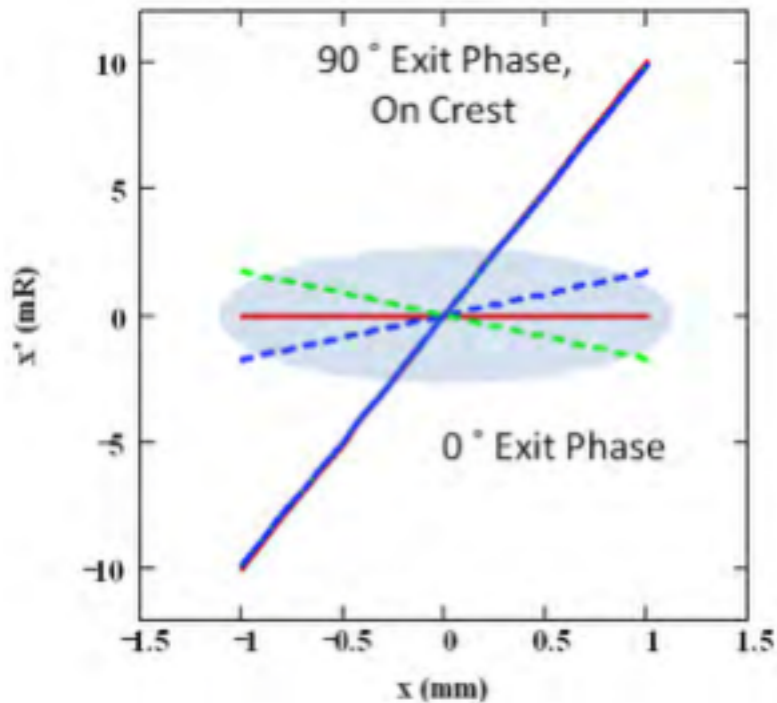

0 deg
 red solid: center slice
 blue dash: head slice
 green dash: tail slice
90° phase spaces
 all lie on the same diagonal line
The linear (first-order) emittance for an exit phase of 90° is zero, as shown by the diagonal line.

$$x' = \frac{x}{f_{RF}} \rightarrow \Delta x' = -\frac{d}{d\phi} \left(\frac{1}{f_{RF}} \right) \Delta x \Delta \phi$$

$$\sigma_{x'} = \frac{eE_0 \cos \phi}{2\gamma mc^2} \sigma_x \sigma_\phi$$

$$\epsilon_n = \beta\gamma \sqrt{\langle x^2 \rangle \langle x'^2 \rangle - \langle xx' \rangle^2} = \beta\gamma \sigma_x \sigma_{x'}$$

Correlation is neglected for exit phase far from 90 deg

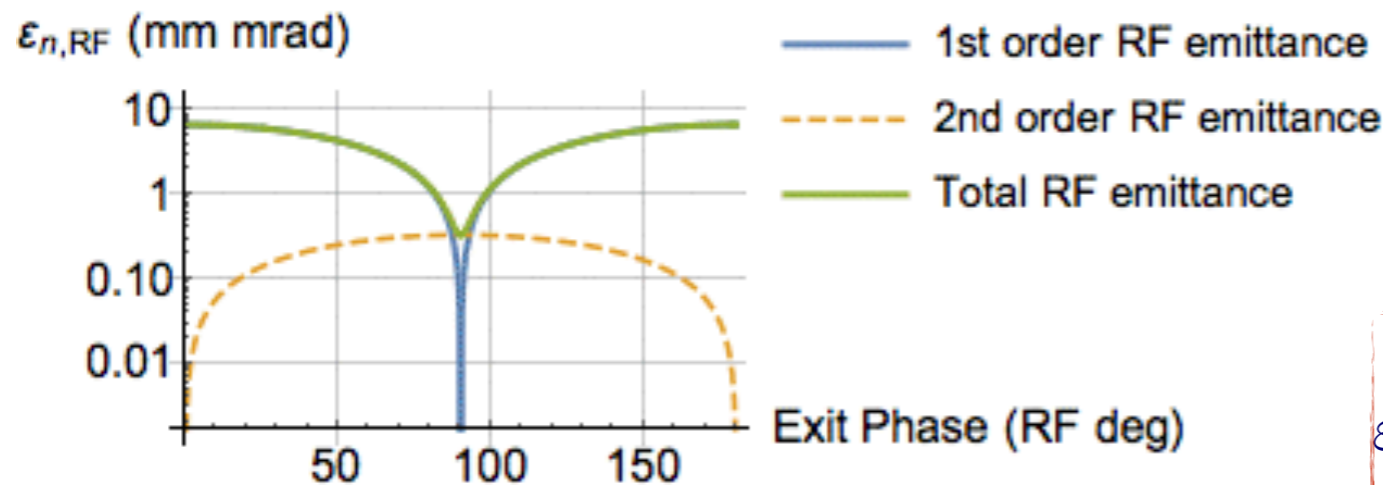

$$\epsilon_n^{RF} = \frac{eE_0}{2mc^2} \sigma_x^2 \sigma_\phi \sqrt{\cos^2 \phi + \frac{\sigma_\phi^2}{2} \sin^2 \phi}$$

1st order RF emittance linear in σ_ϕ

$$\sigma_\phi = 4 \text{ deg} \Leftrightarrow 10 \text{ ps FWHM}$$

$$\sigma_x = 1 \text{ mm}, E_0 = 100 \text{ MV/m}$$

Space Charge Effects

Let's consider first space charge forces in highly relativistic bunches

- Laboratory system: N relativistic electrons uniformly distributed in a cylinder with radius r_b and length L_b
- Co-moving particle coordinate system: electrons are at rest and a pure Coulomb field inside the bunch

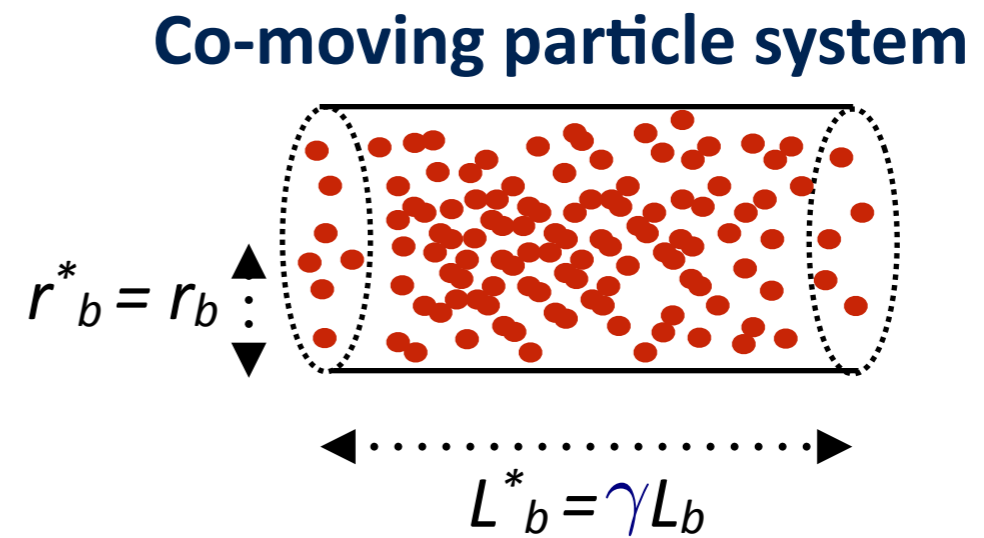
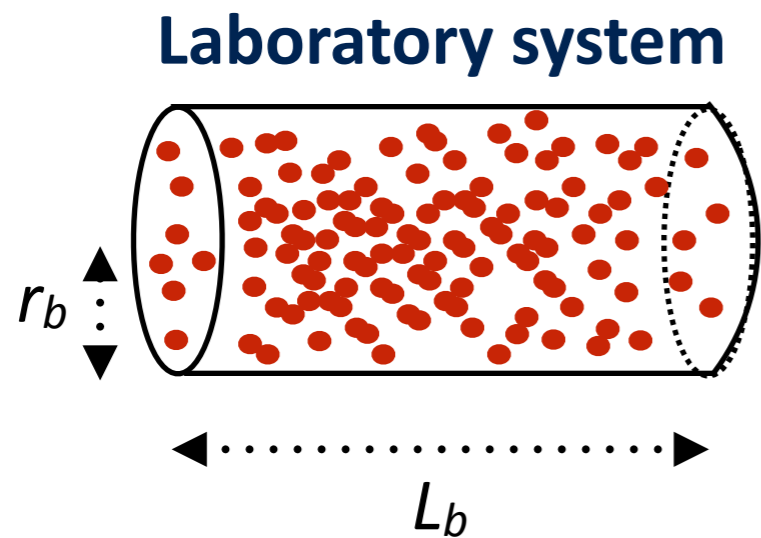

$\gamma \gg 1$, $L_b^* \gg L_b$: the approximation of infinitely long cylindrical charge distribution is valid and the electric field has only a radial component

$$E_r^*(r) = -\frac{Ne}{2\pi\epsilon_0 L_b^*} \frac{r}{r_b^2} , r \leq r_b$$

$$E_r^*(r) = -\frac{Ne}{2\pi\epsilon_0 L_b^*} \frac{1}{r} , r \geq r_b$$

Space Charge Effects

Transforming back to the laboratory frame the radial component of the electric field yields to a radial electric field and an azimuthal magnetic field

$$E_r(r) = \gamma E_r^*(r) = -\frac{Ne}{2\pi\epsilon_0 L_b} \frac{r}{r_b^2}$$

$$B_\phi = \frac{v}{c^2} E_r(r), \quad r \leq r_b$$

The force a test electron inside the bunch experiences due to the E_r and B_{phi} field is determined through the Lorentz force

$$\vec{F} = -e(\vec{E} + \vec{v} \times \vec{B})$$

$$F_r(r) = \frac{Ne^2}{2\pi\epsilon_0 L_b} \frac{r}{r_b^2} \left(1 - \frac{v^2}{c^2}\right) = \frac{Ne^2}{2\pi\epsilon_0 L_b} \frac{r}{r_b^2} \frac{1}{\gamma^2}$$

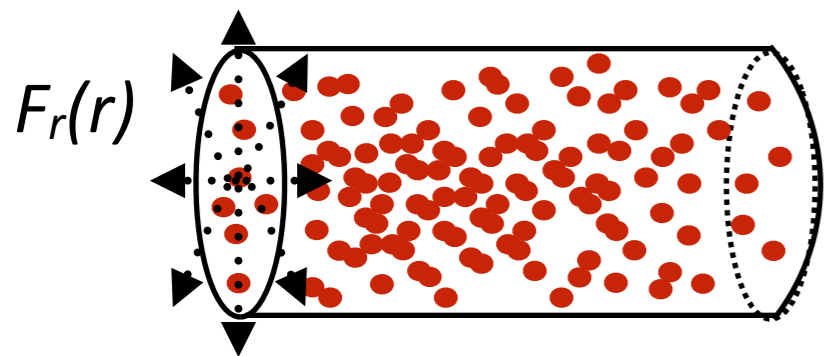

The overall force points outwards and is then a defocusing force, which vanishes for $\gamma \rightarrow \infty$

Space Charge Dependence on Charge Density Distribution

For the cylindrical electron bunch with constant charge density, the total space charge force depends linearly on the displacement r from the axis

$$F_r(r) = \frac{Ne^2}{2\pi\epsilon_0 L_b} \frac{r}{r_b^2} \frac{1}{\gamma^2}$$

What happens in case of a Gaussian transverse density distribution?

$$F_r(r) = \frac{Ne^2}{2\pi\epsilon_0 L_b r} \left[1 - e^{-\frac{r^2}{2\sigma^2}} \right] \frac{1}{\gamma^2}$$

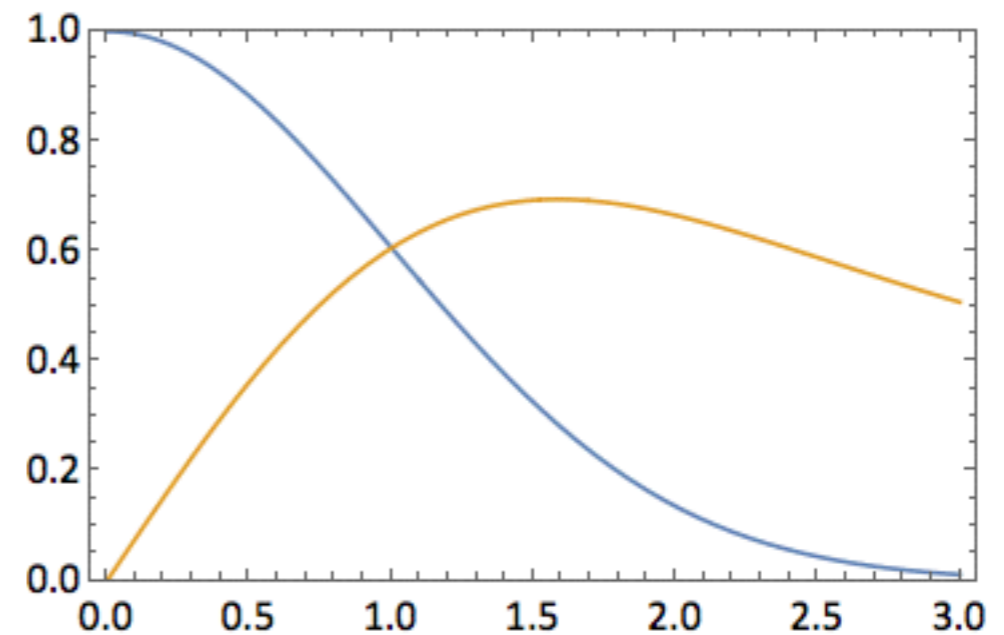
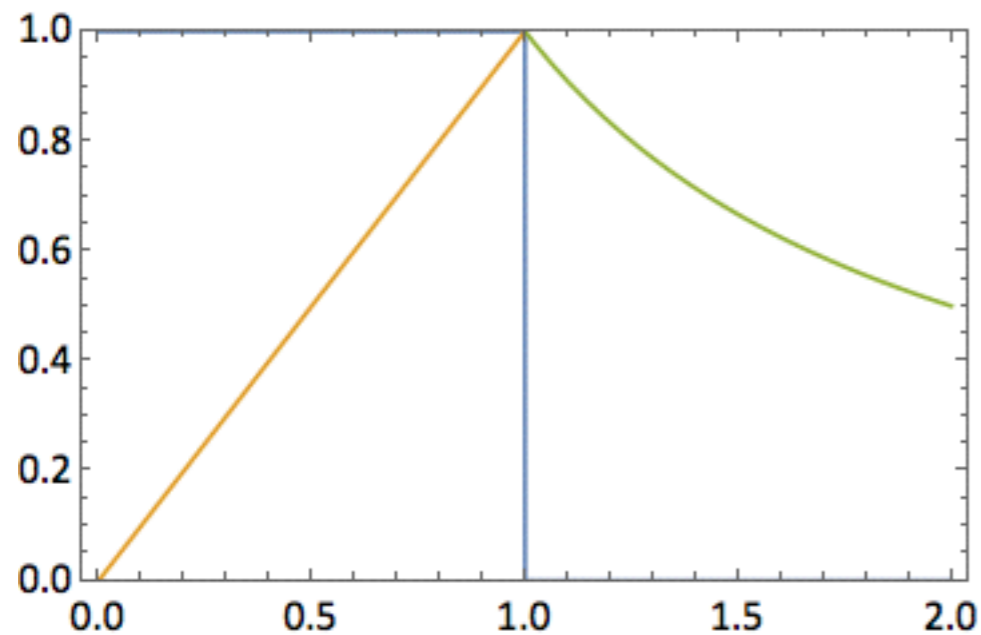

(Gun) Compensating Solenoid

- The beam wants to diverge for 2 reasons
 - Space charge
 - The electron bunch coming off the cathode is very dense and wants to expand violently due to the electrostatic force
 - Divergent RF Fields within the RF gun
 - Anytime the electric field varies longitudinally there is a radial field
- The solenoid focuses the low energy beam radially
- Beam enters the end radial field of the solenoid and gets a transverse kick $\text{div}E=0 \Rightarrow Dr' \text{ prop to } -rdEz/dz$
- This new transverse motion crosses the longitudinal field and rotates inward or outward depending on the solenoid polarization
- The particle is then closer in (assuming focusing) when passing through the end radial field at the opposite end of the solenoid and since it is further in the kick is less.
- MULTIPLE ROLE of the SOLENOID
 - It cancels the strong negative RF lens
 - it is crucial for emittance compensation by aligning the slices transversely along the bunch to minimize the projected emittance
 - Imaging the electron emission from the cathode to have a good representation of the true QE map

Matching the low energy beam to the booster linac

- In addition to compensating for the emittance from the gun, it is necessary to carefully match the beam into a high-gradient booster to damp the emittance oscillations. The required matching condition is referred to as the Ferrario working point (M. Ferrario et al., "HOMDYN study for the LCLS RF photo-injector", SLAC-PUB-8400, LCLS-TN-00-04, LNF-00/004(P))
- The working point matching condition requires the **emittance to be a local maximum and the envelope to be a waist at the entrance to the booster**. The waist size is related to the strength of the RF fields and the peak current.
- RF focusing aligns the slices and acceleration damps the emittance oscillations.
- **Experimental evidence has been proved at the SPARC high brightness photo-injector**

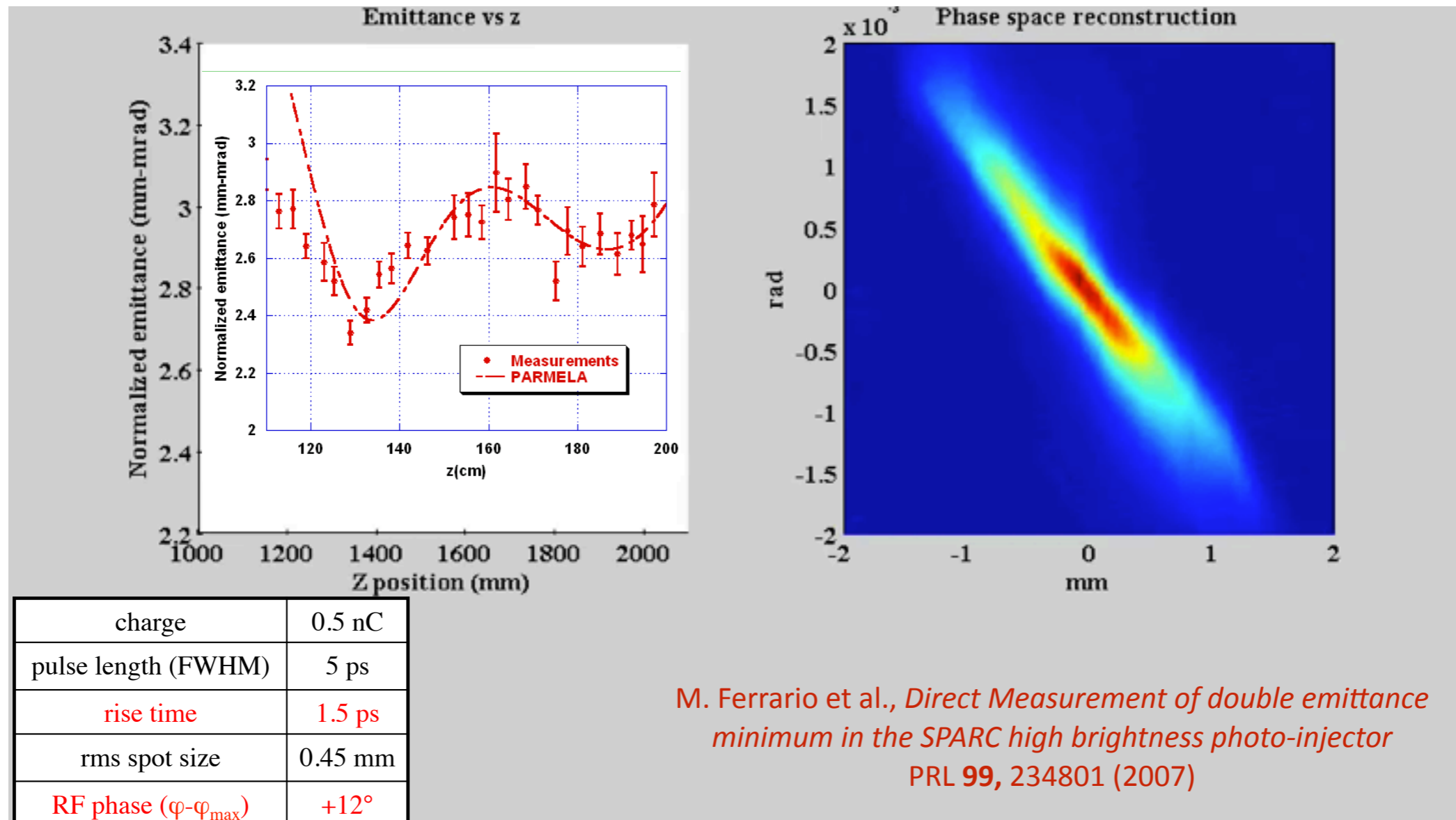

M. Ferrario et al., *Direct Measurement of double emittance minimum in the SPARC high brightness photo-injector*
PRL **99**, 234801 (2007)

...

- To preserve brightness, it is desirable to accelerate the beam as quickly as possible, thus 'freezing-in' the space charge forces, before they can significantly dilute the phase space
 - RF gun
- Space charge can be controlled by reducing the beam charge density, especially in the cathode region where the beam energy is low
 - Larger transverse beam sizes at the cathode to reduce the density, but this increases the cathode intrinsic emittance
- Space charge can be also controlled by increasing the bunch length
 - Increase of longitudinal emittance
 - This in turn necessitates compression methods

Picosecond electron bunches are produced in RF guns with peak current less than 100 A. Bunch compressors are used to compress the bunches to tens of femtoseconds to produce kA peak current at higher beam energy.

RF Compression: Velocity Bunching

Sub-relativistic electrons ($\beta_c < 1$) injected into a traveling wave cavity at zero crossing move more slowly than the RF wave ($\beta_{RF} \sim 1$). The electron bunch slips back to an accelerating phase and becomes simultaneously accelerated and compressed. Rectilinear trajectories => non coherent synchrotron radiation emission

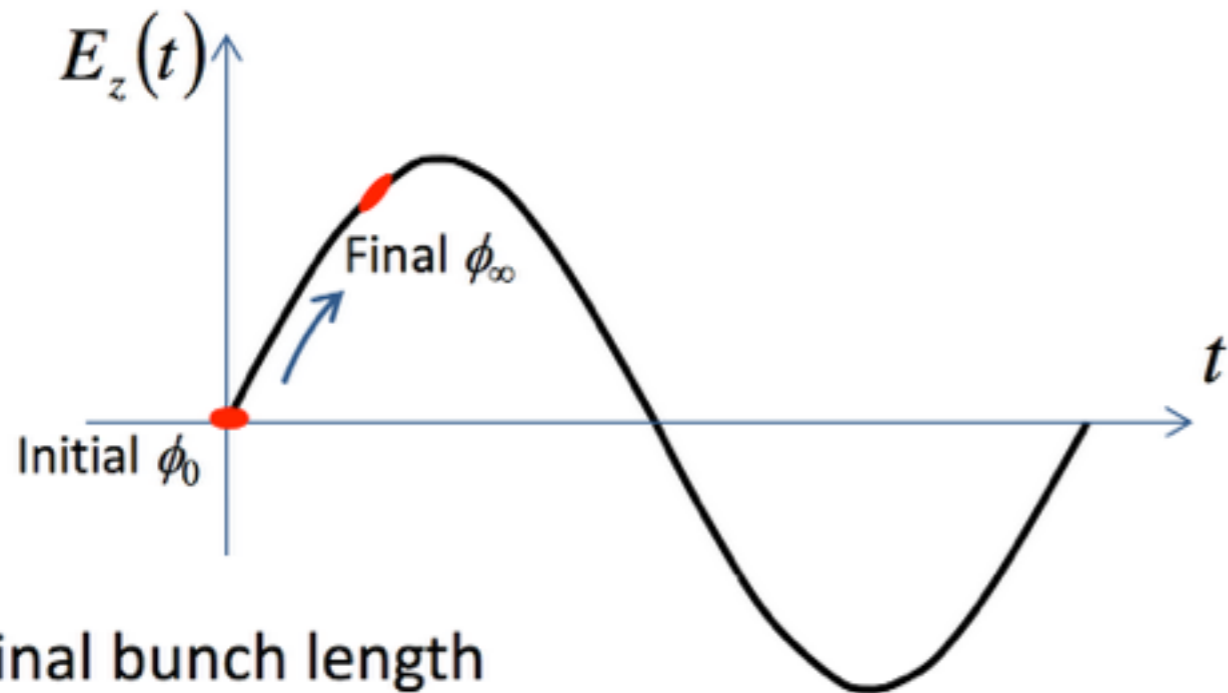

Final bunch length

$$\sigma_{z_f} = \frac{\sin \phi_0}{\sin \phi_\infty} \sigma_{z_i} + \frac{1}{2\alpha\gamma_0^2 \sin \phi_\infty} \sigma_{\gamma_i}$$

Injection phase slippage

Contribution from initial energy spread

Zoom in of the phase space plot for a slow wave

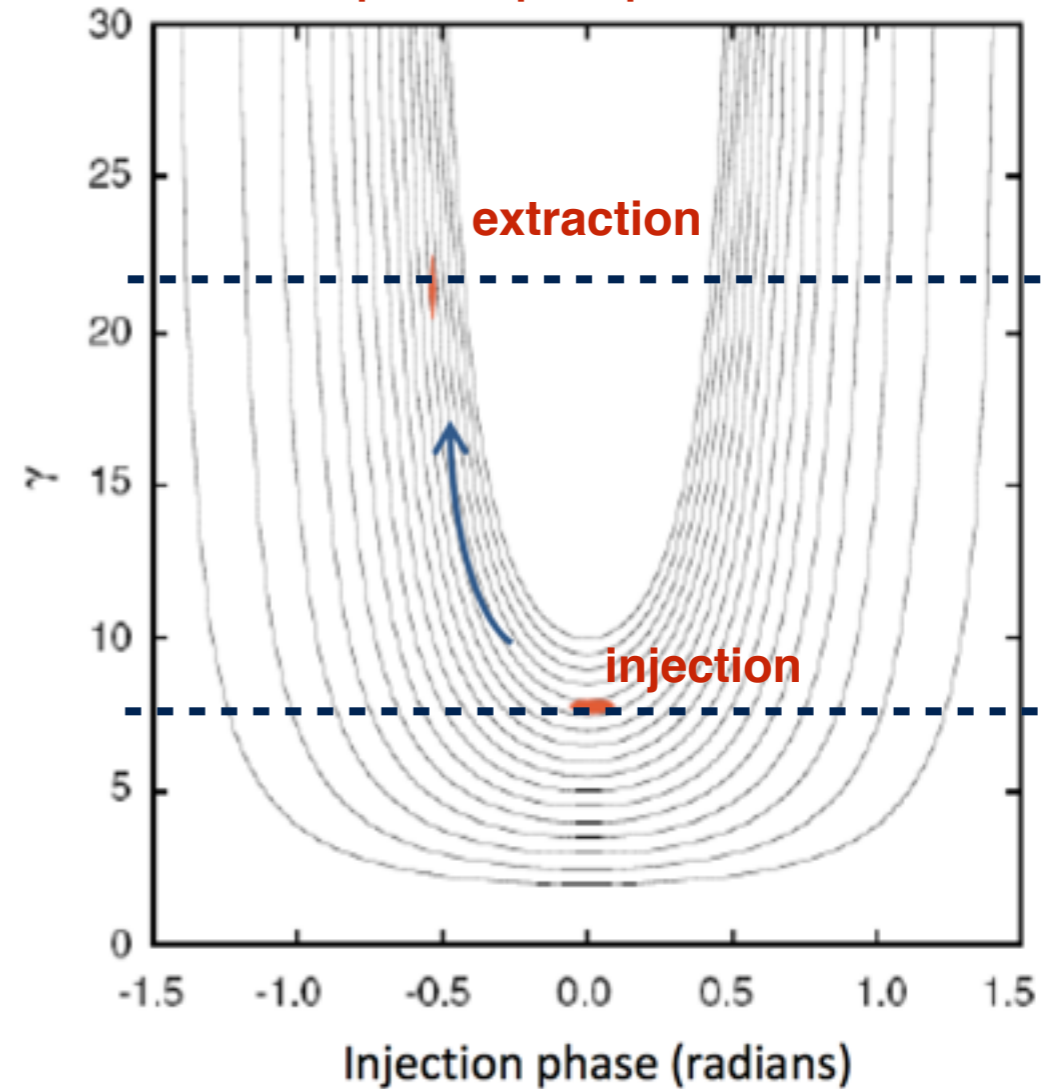

Initial $\beta_c = 0.994$ at 4 MeV

- L. Serafini and M. Ferrario, *Velocity Bunching in Photo-injectors*, Physics of, and Science with the X-Ray Free-Electron Laser, edited by S. Chattopadhyay et al. © 2001 American Institute of Physics
- M. Ferrario et al., *Experimental Demonstration of Emittance Compensation with Velocity Bunching*, Phys. Rev. Lett. **104**, 054801 (2010)

Virtual Operation of a HB Photo-injector
The SPARC_LAB experience

The SPARC_LAB Test Facility

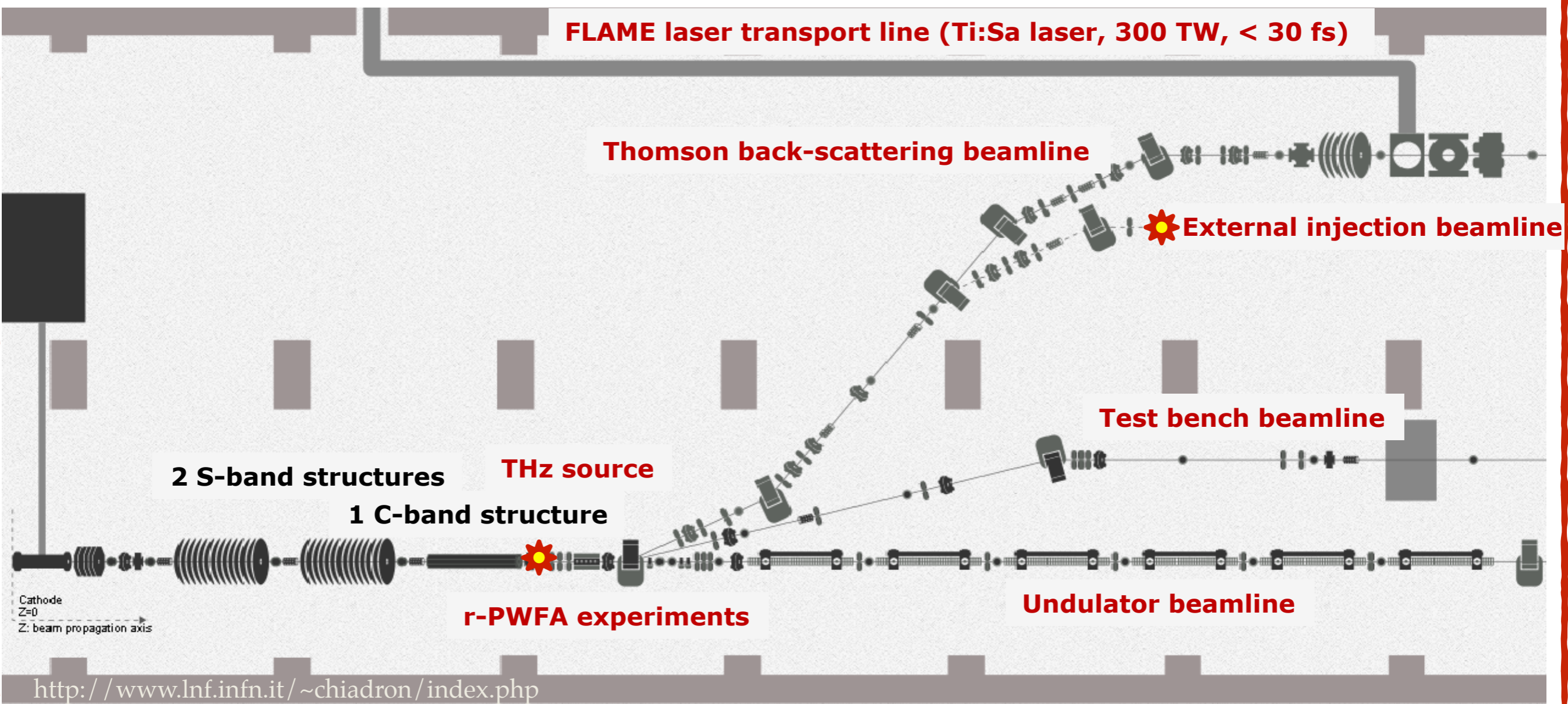

Electron Emission

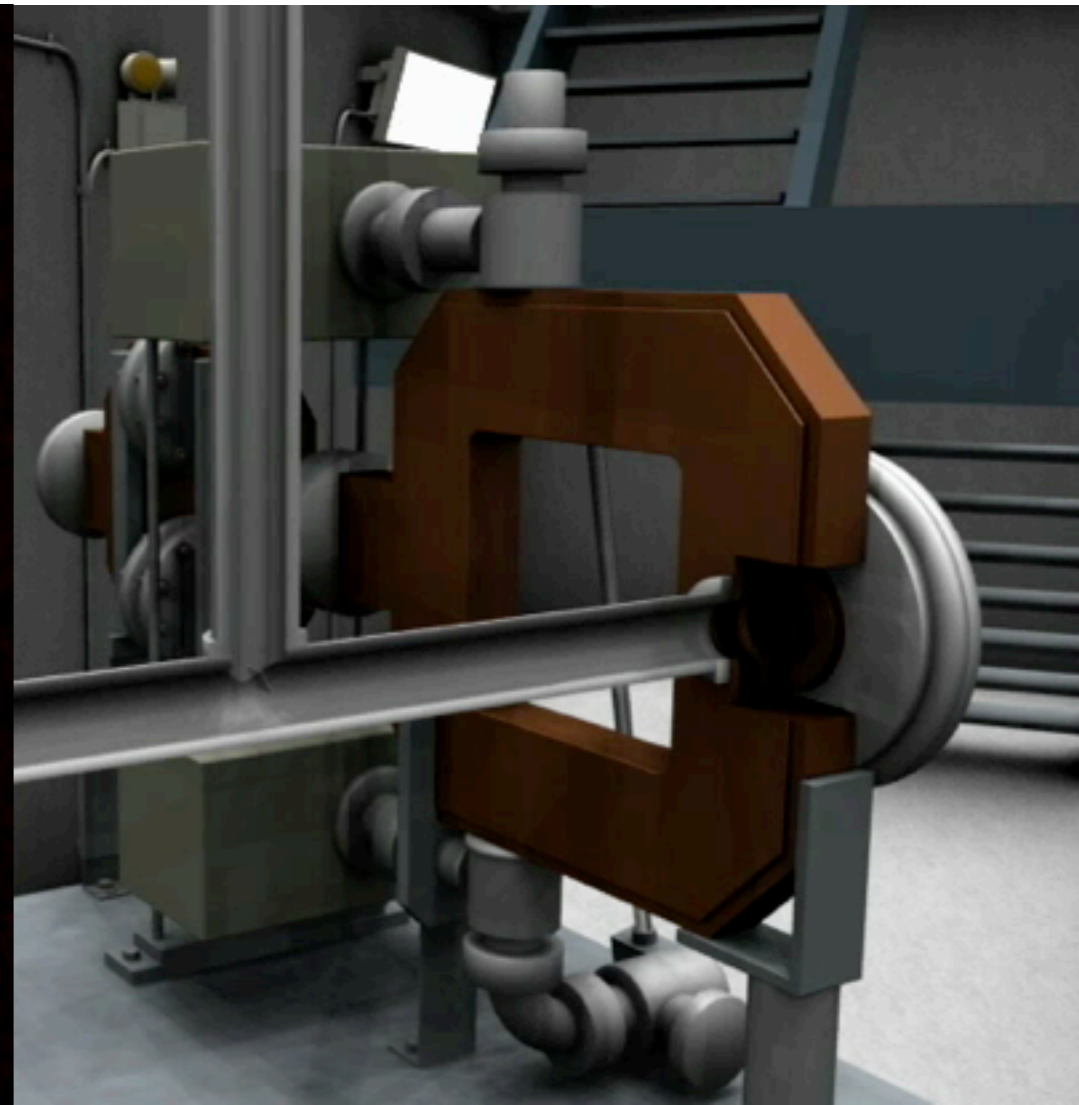

The extracted charge depends on the applied RF field and the RF gun phase

Radial expansion of the beam indicates the laser pulse is well aligned on the cathode, therefore the electron beam experience a radial force

The photo-cathode laser (266 nm) impinges on the copper cathode and electrons start to be extracted

Phase Scan

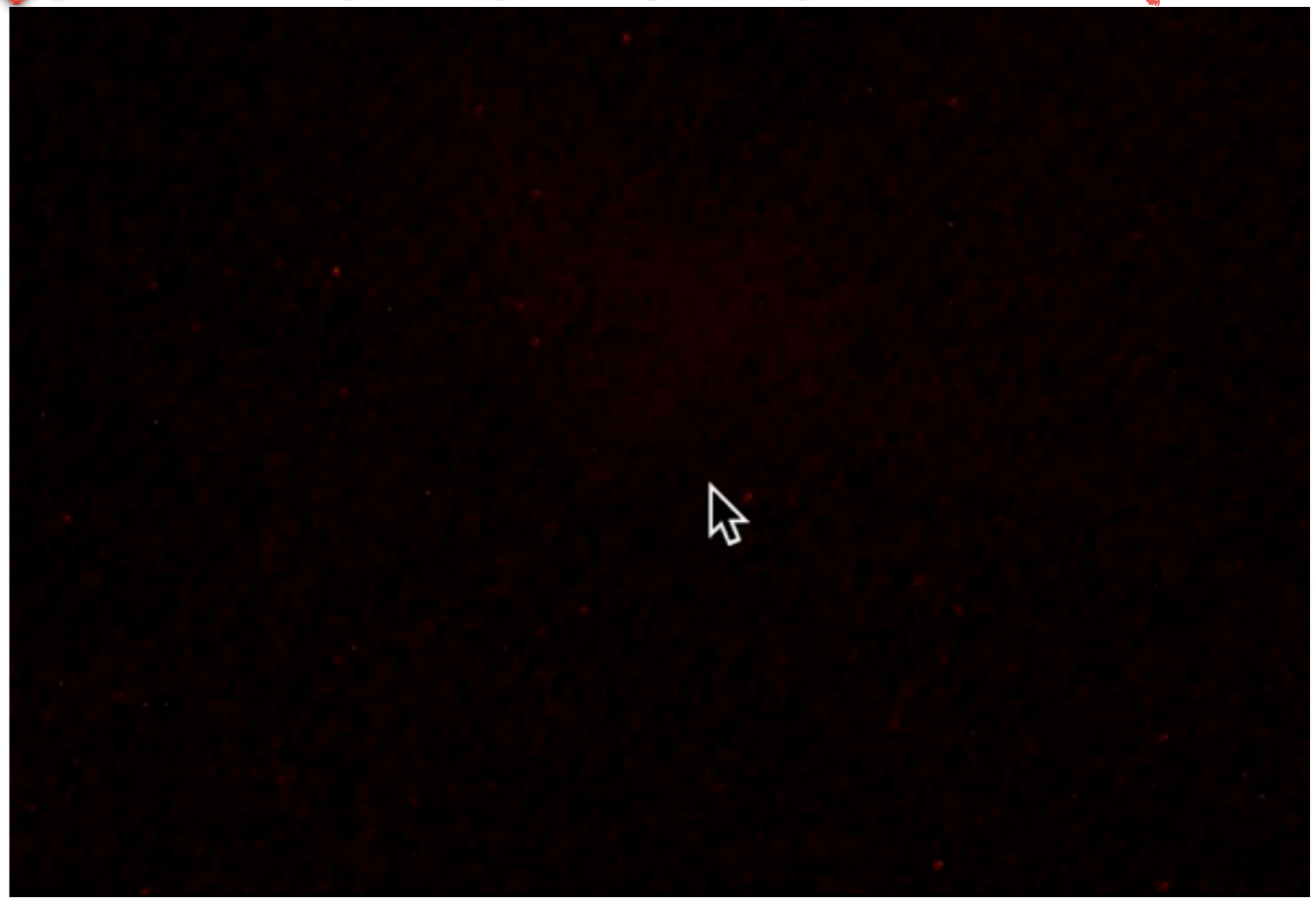
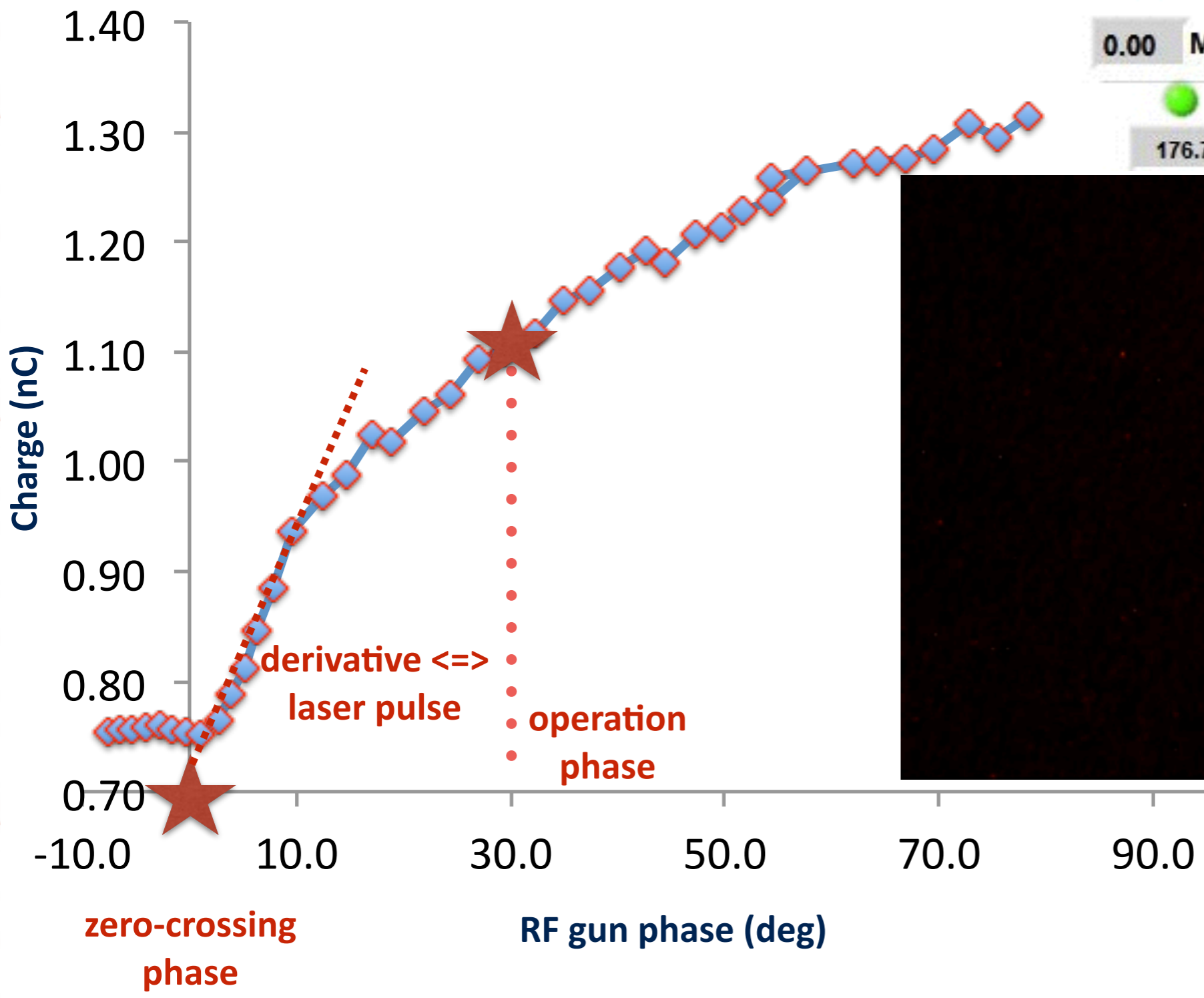
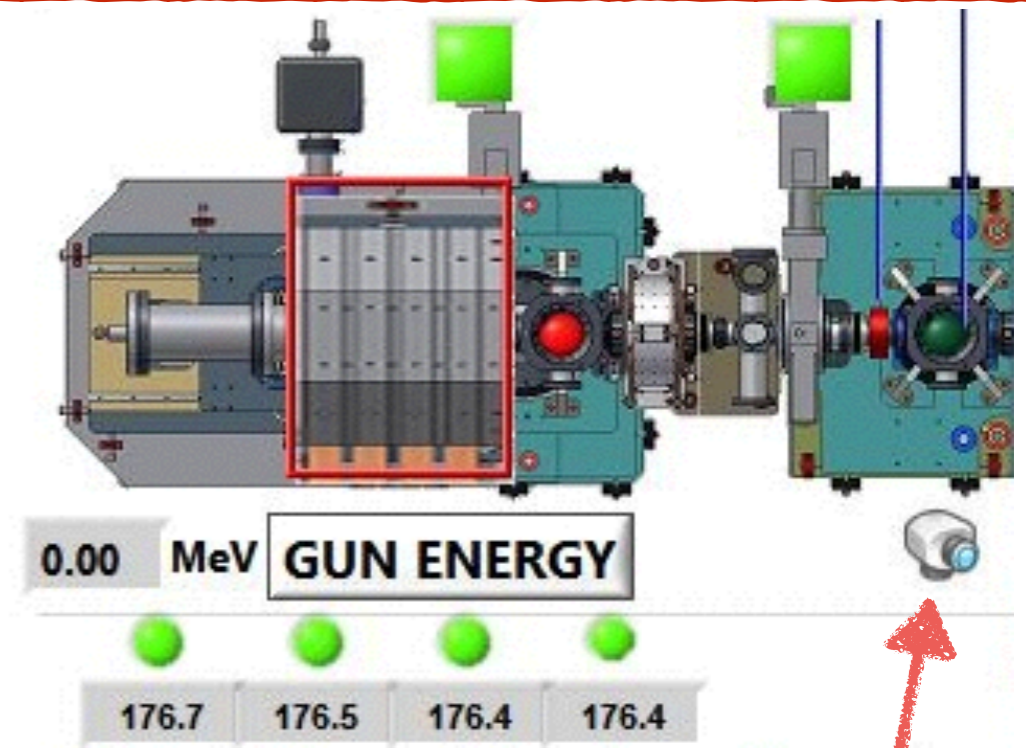

Beam Injection and "on crest" acceleration

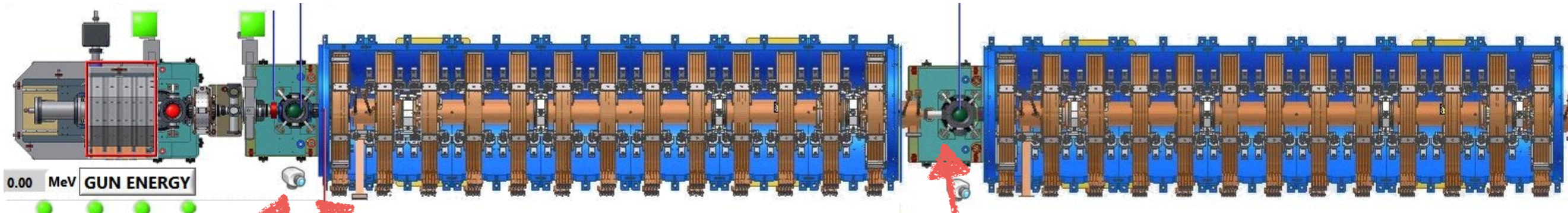

Transverse beam size (mm)

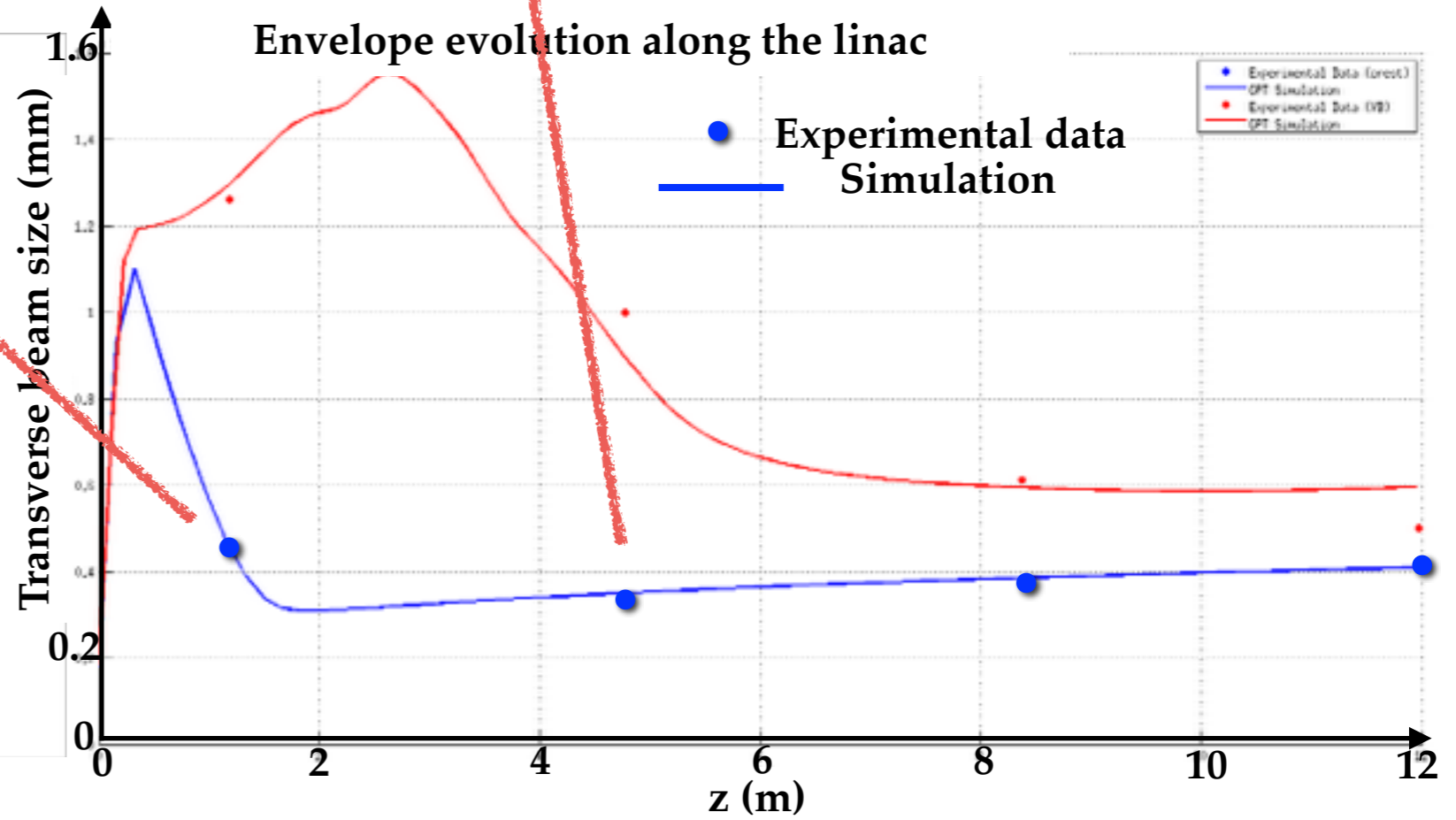
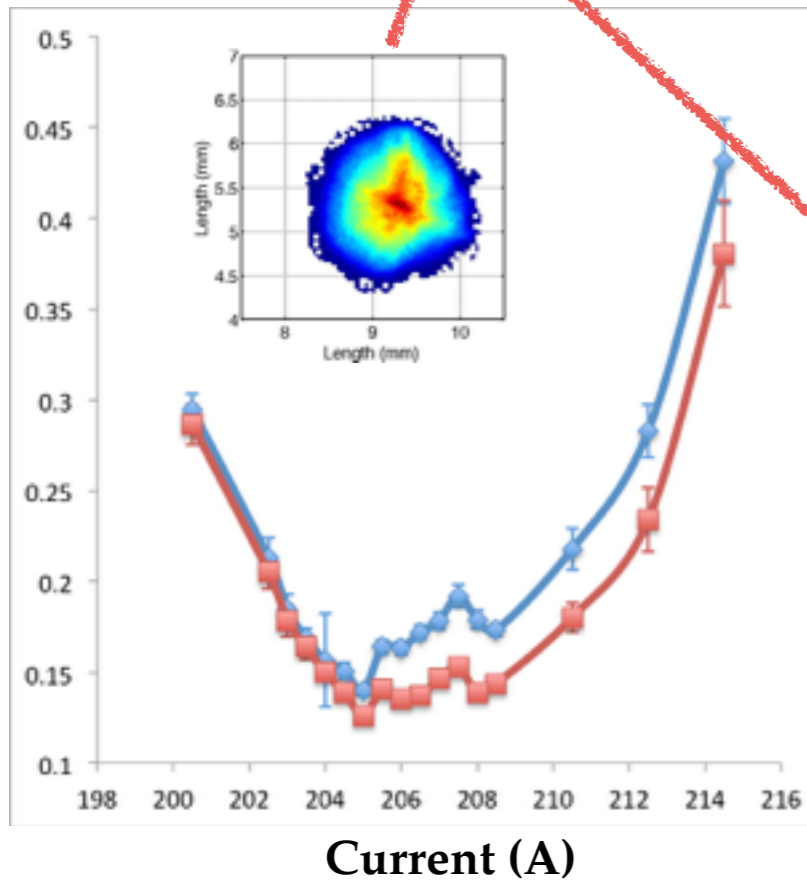

On Crest Emittance Compensation

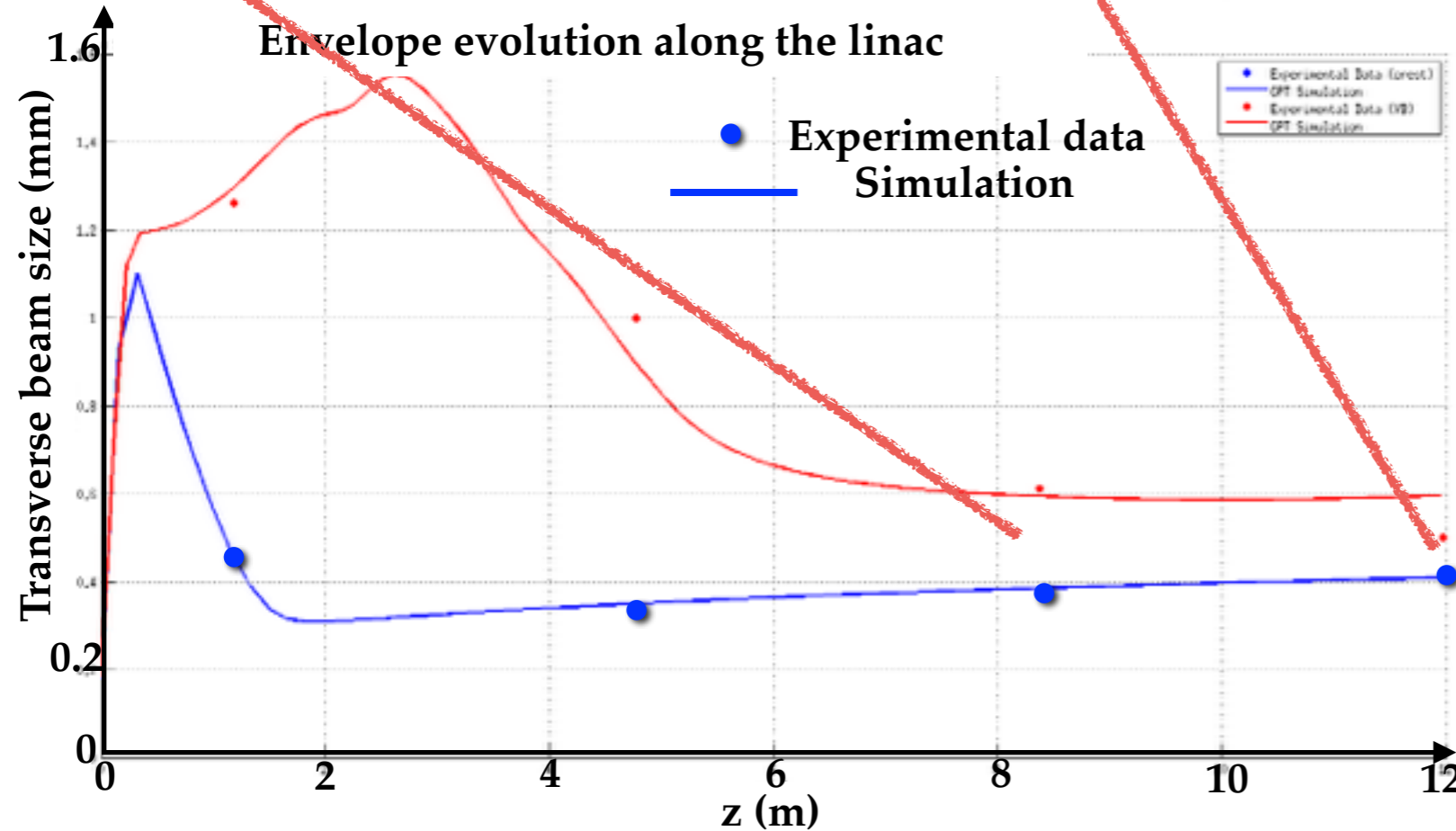
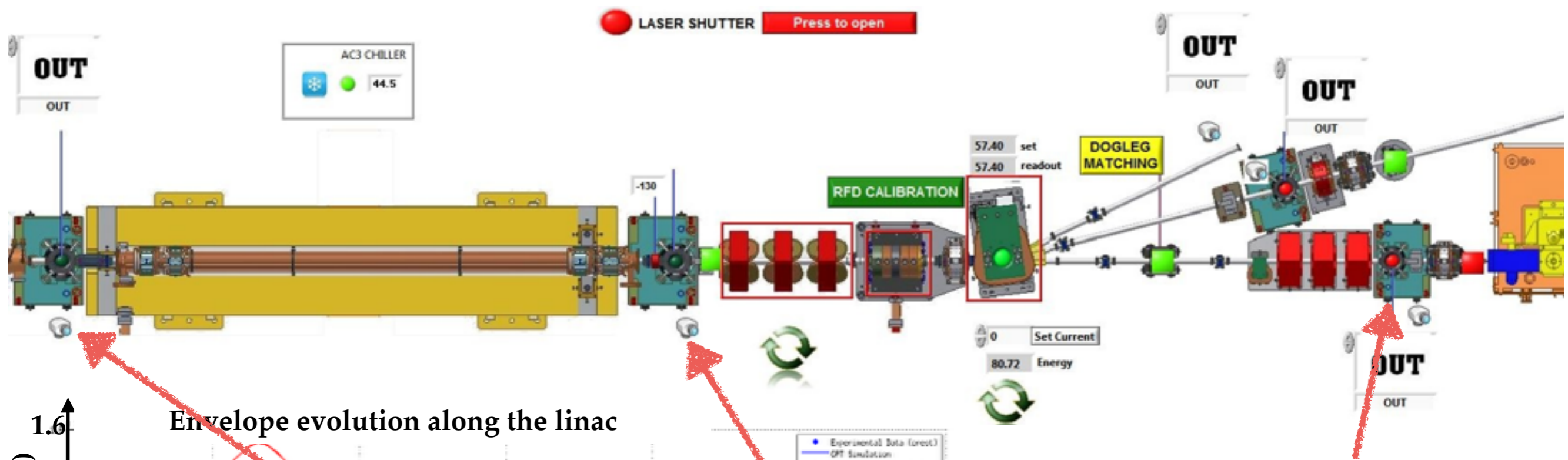

Quadrupole scan emittance measurement

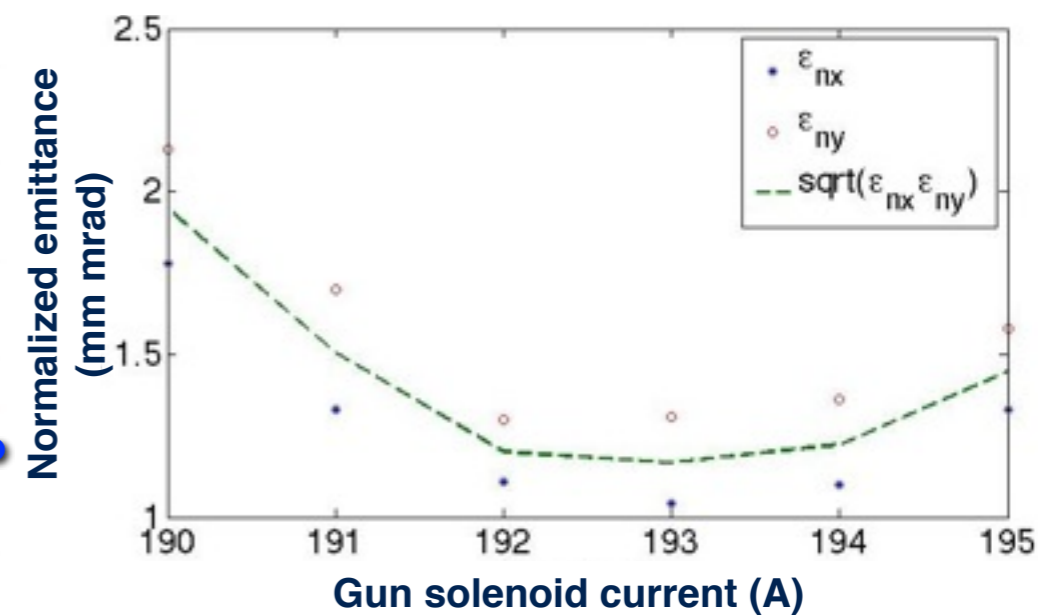

On Crest Energy Measurement

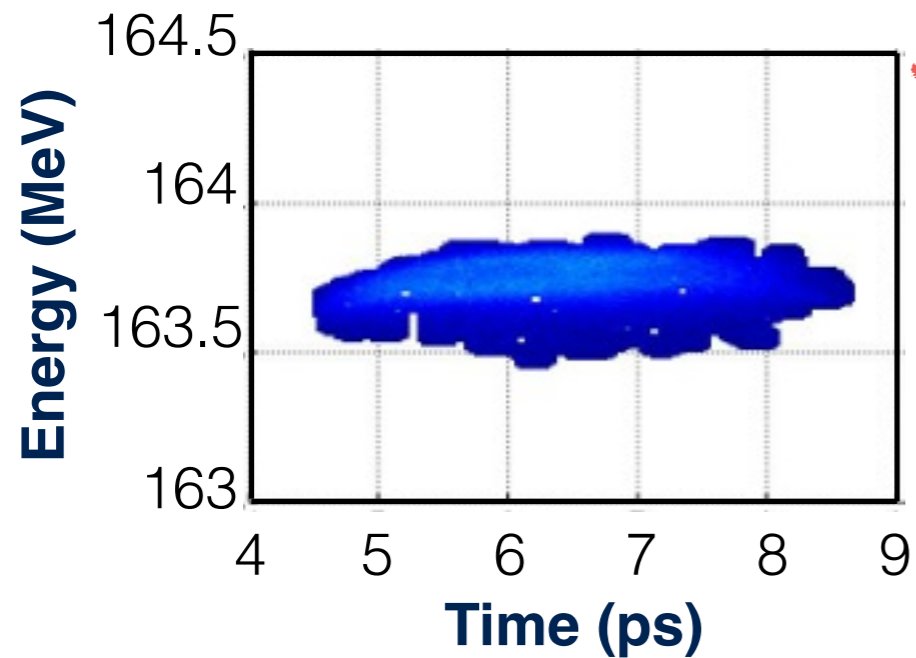
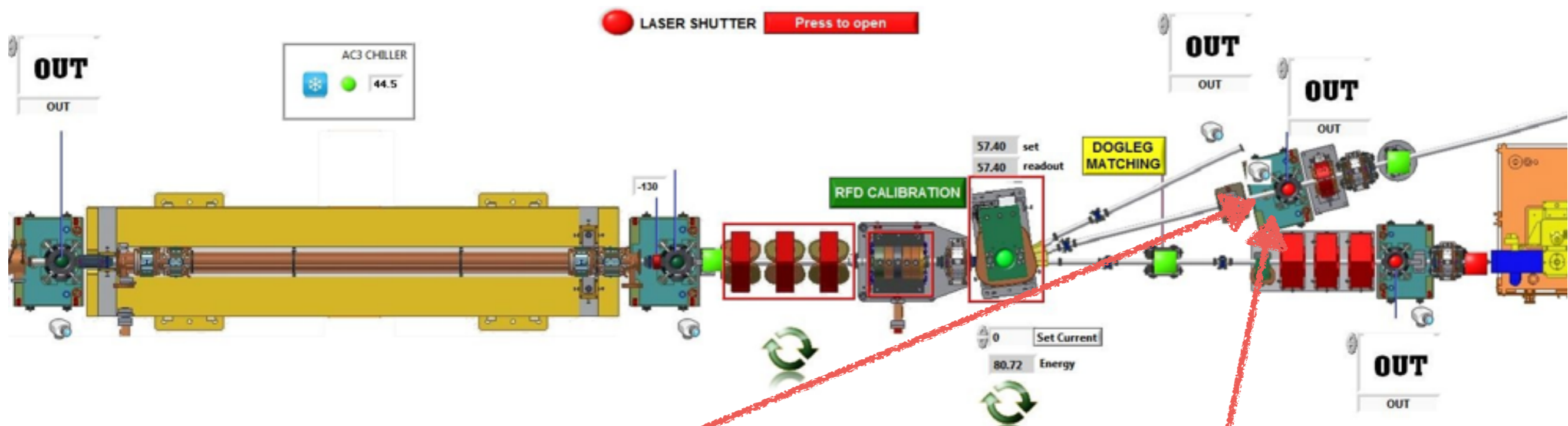

Sub-ps laser pulse

=> The electron beam does not experience RF non-linearities: **linear longitudinal phase space**

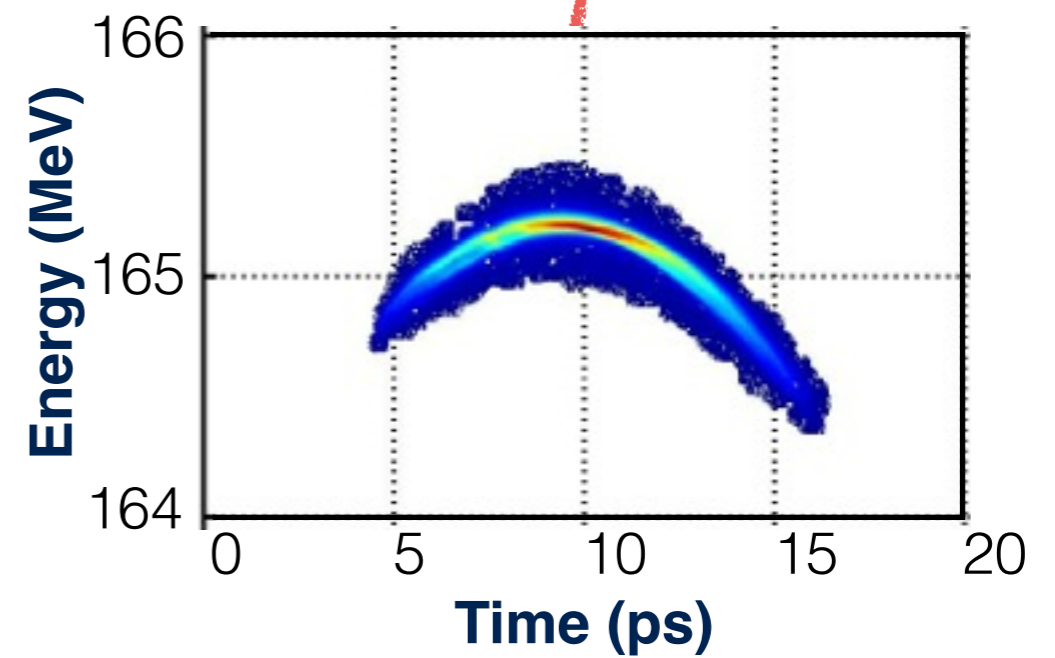

few ps laser pulse

=> The electron beam experiences RF non-linearities: **C-shape longitudinal phase space**

RF Compression

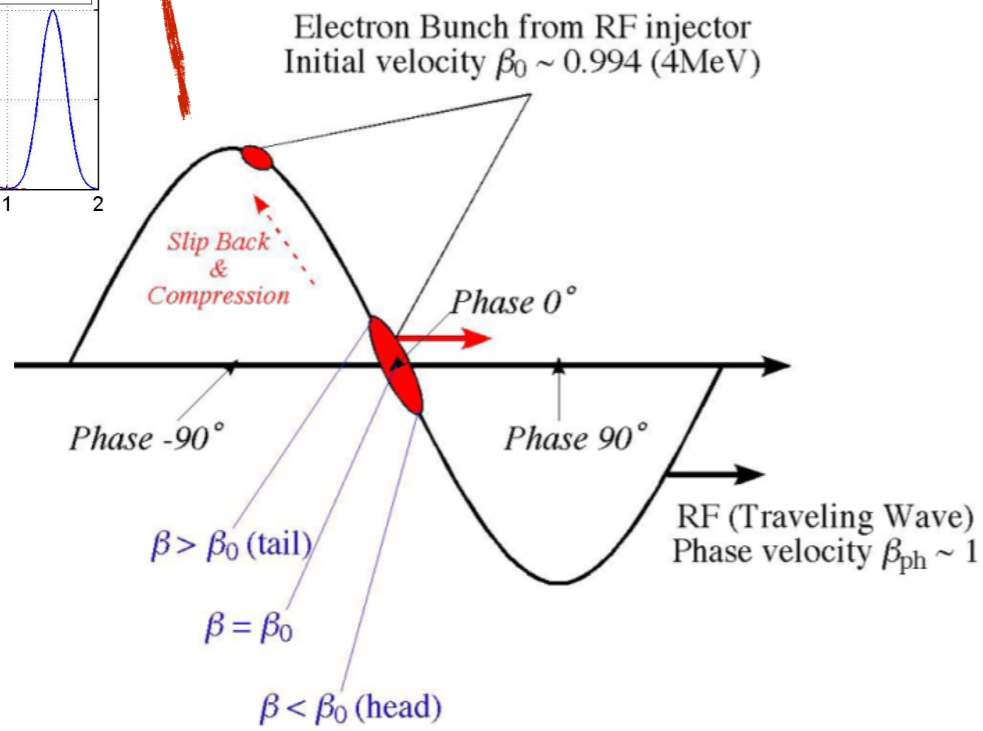
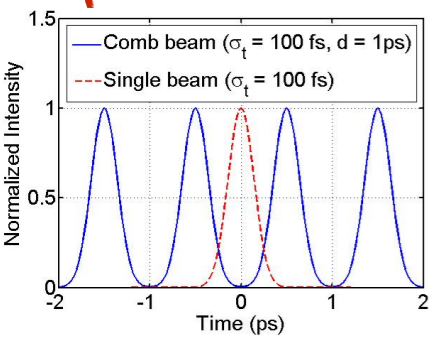
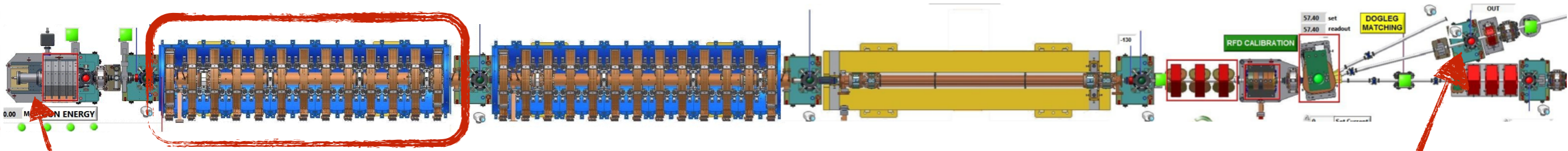

168 MeV, on crest

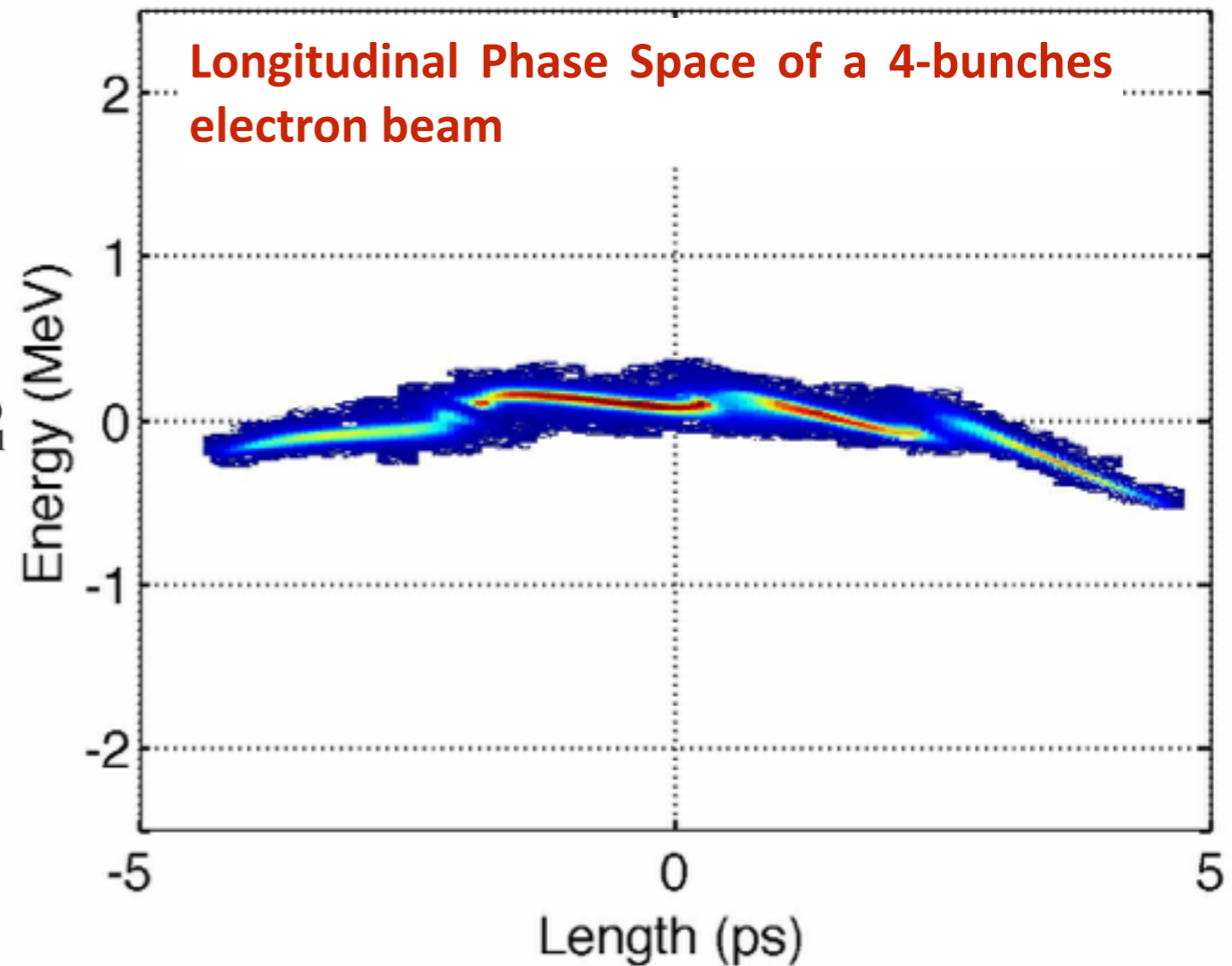

SASE FEL Radiation

Electron beam image on view screens while the gap is closing. Weak FEL radiation already after the third module. **Measurements at the SPARC_LAB Test Facility (INFN-LNF)**

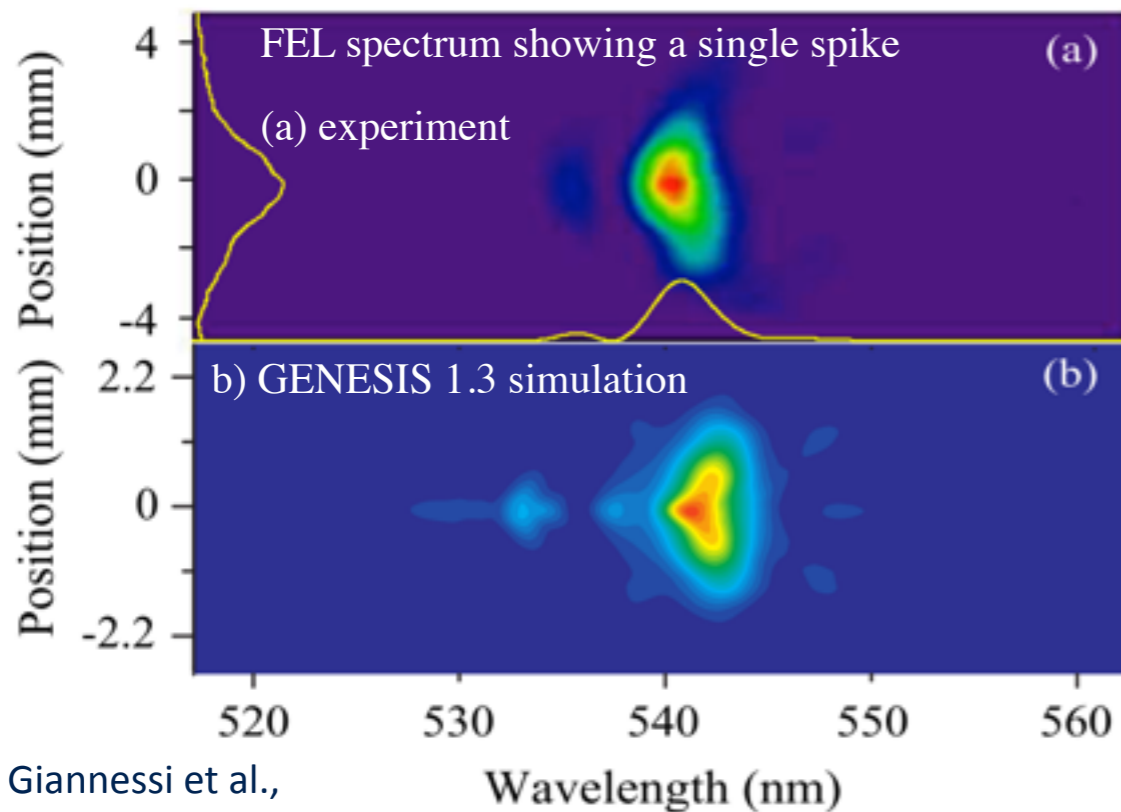
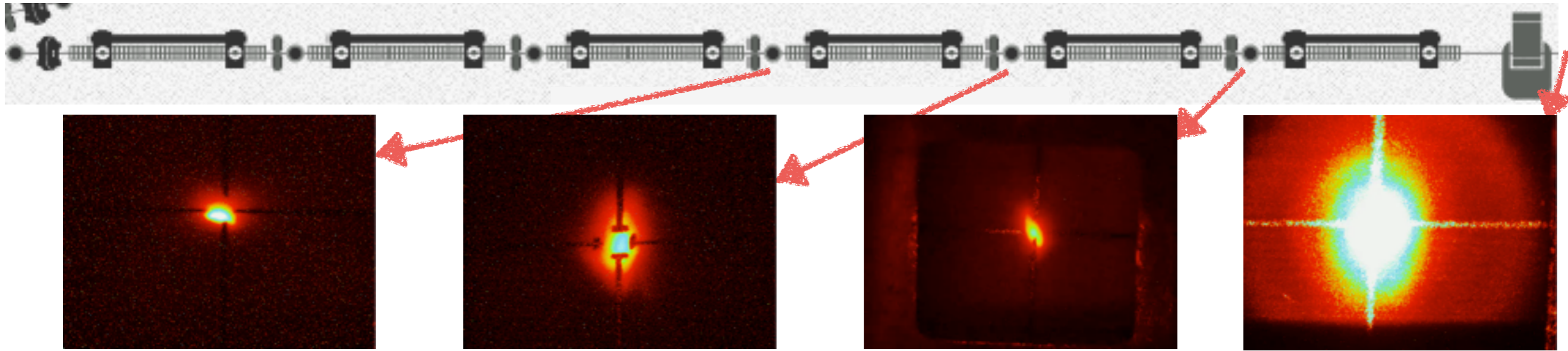

S. Reiche, Simulation Code Genesis 1.3

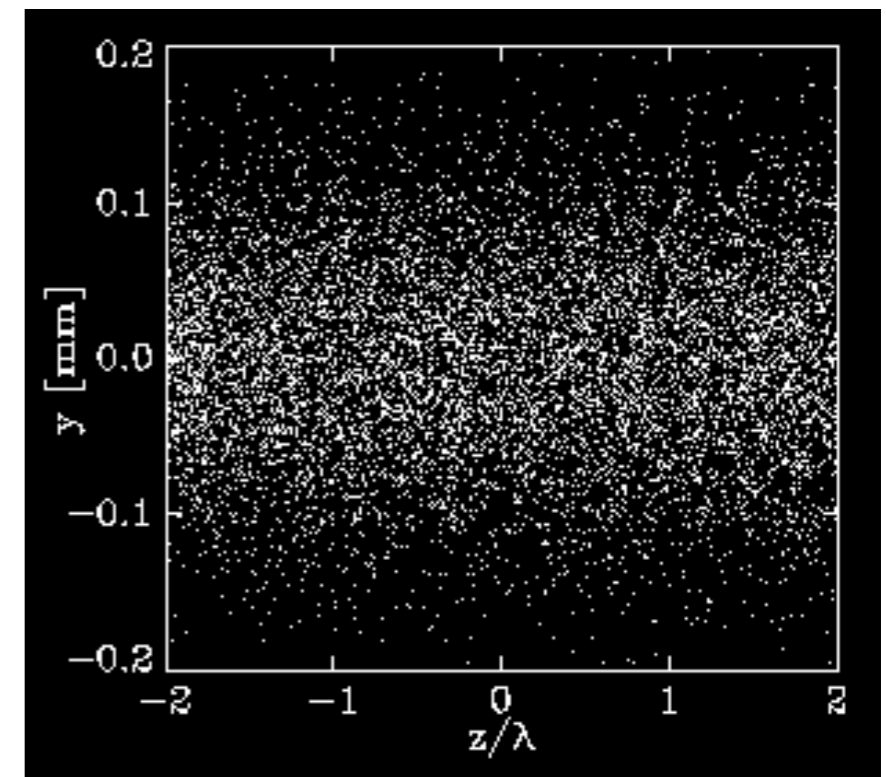

Bibliography and Acknowledgment

Material from these lectures has been liberally taken from talks/papers/lectures/proceedings/notes from a large number of people which I acknowledge here together with a list of references

- W. Anders, I. Bazarov, L. Cultrera et al., *An Engineering Guide to Photo-injector*, Editors D.H. Dowell and T. Rao, ISBN-13: 978-1481943222, ISBN-10: 1481943227
- <http://uspas.fnal.gov/materials/10MIT/MIT-High-Brightness.shtml>
- I. Bazarov et al., PRL **102**, 104801 (2009)
- K. Floettmann, *rf-induced beam dynamics in rf guns and accelerating cavities*, PRST AB 18, 064801 (2015)
- S. Di Mitri, M. Cornacchia, *Electron beam brightness in linac drivers for free-electron-lasers*, Physics Reports (2014), <http://dx.doi.org/10.1016/j.physrep.2014.01.005>
- P. Schmueser, M. Dohlus, J. Rossbach, *Ultraviolet and Soft X-rays Free Electron Lasers*, Springer (2008)
- T. P. Wangler, *RF Linear Accelerators*, Wiley-VCY
- http://uspas.fnal.gov/materials/14UNM/E_Bunch_Compression.pdf
- P. Musumeci's Lecture at <https://conf-slac.stanford.edu/sssep-2013/lectures>
- SPARC_LAB collaboration