

Energy recovery linacs

*(Recirculating accelerators-recuperators,
multipass accelerators-recuperators)*

Gennady Kulipanov

*Budker Institute of Nuclear Physics
Novosibirsk, Russia*

*Joint US-CERN-Japan-Russia School
Synchrotron Radiation & Free Electron Lasers
Erice, Italy, 6-15 April 2011*

Contents of the lecture:

1. Introduction. History of SR sources.
2. Requirements to the 4th generation SR sources.
3. Comparison of storage rings, linacs and recirculating accelerators-recuperators as SR sources.
4. History of recirculating accelerators, accelerators-recuperators and development of the SC technology.
5. Operating FELs based on low-energy accelerators-recuperators
6. Planned SR sources based on high energy accelerators-recuperators.
7. Technical solutions for realization of the 4th generation SR sources based on accelerators-recuperators.
8. Comparison of MARS, SASE FEL and XEL-O.
9. Conclusion.

1. Introduction. History of SR sources

Crab Nebula

6000 light years away

History

First light observed

1054 AD

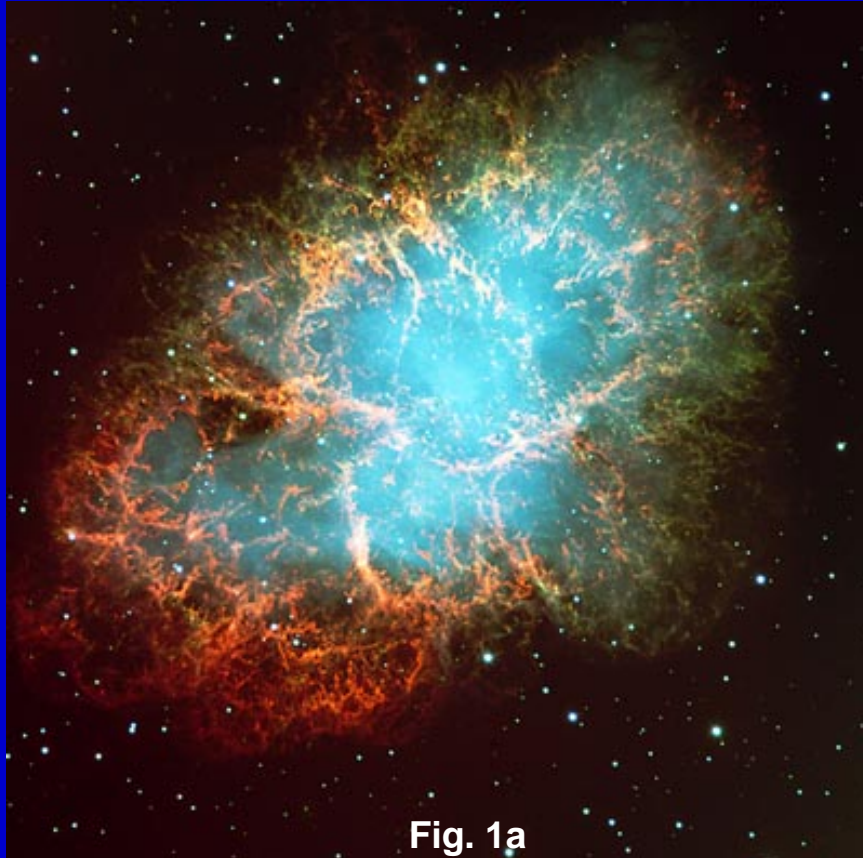

The origin of the Crab Nebula was linked with the supernova outburst in 1054, which was chronicled by Japanese and Chinese monks. The guest star could be seen in the daytime for three weeks and was the brightest star in the night sky for one year. In the middle of the past century, it was hypothesized that the Crab Nebula glare is the synchrotron radiation of ultra-relativistic electrons in interstellar magnetic fields, which idea was validated later.

GE Synchrotron New York State

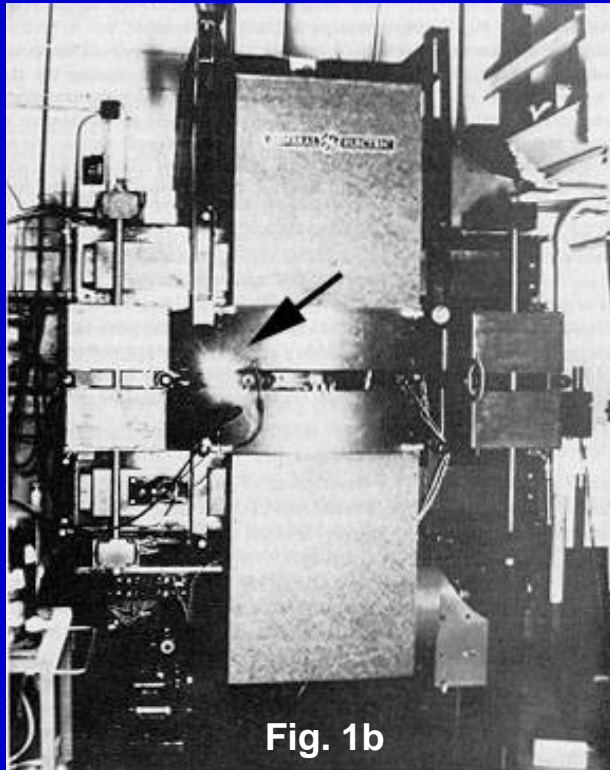

Fig. 1b

First light observed
1947

Figure 1b shows a photograph of artificial synchrotron radiation, first observed in 1947 on one of the first electron accelerators – a synchrotron made by the General Electric company in the USA.

The events illustrated by Figs. 1a and 1b were separated by nine hundred years. Such was the period of time necessary for mankind to comprehend that the glow of the Crab Nebula is produced by synchrotron radiation, on the one hand, and, on the other, to devise modern physics, to elaborate the theory of synchrotron radiation, to establish principles and develop methods for accelerating charged particles and, then, to create charged particle storage rings and special generators of synchrotron radiation – undulators and wigglers.

ELECTRON SYNCHROTRONS – FIRST SOURCES of SR

1. V. I. Veksler (1944) Comptes Rendus de

l' Academic Sciences de l' URSS V. 43, 8, p.329

E. Mc. Millan (1945) Phys. Rev. V. 68, p. 144-145 independently discovered the principle of phase stability for RF acceleration of charged particles moving in by a circular orbit.

General Electric synchrotron (USA), FIAN synchrotron USSR), Cornell synchrotron (USA), Frascati synchrotron (Italy)

2. E. D. Courant, M. S. Livingston, M. S. Snyder (1952)

invented strong focusing synchrotron

CEA (USA), NINA (UK), ARUS (USSR), DESY (Germany)

3. The further progress of SR sources is associated with the development of storage rings for high energy physics colliders (AdA, VEP-1, PSSR)



**B. Touschek
(Frascati)**



**D.K. O'Neill
(Princeton)**

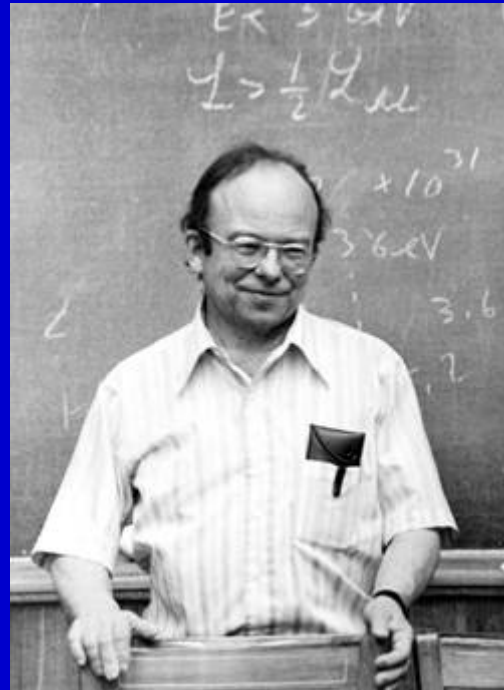

**W. Panofsky
(Stanford)**



**G. Budker
(Novosibirsk)**

**First Italy-France
storage ring
AdA**

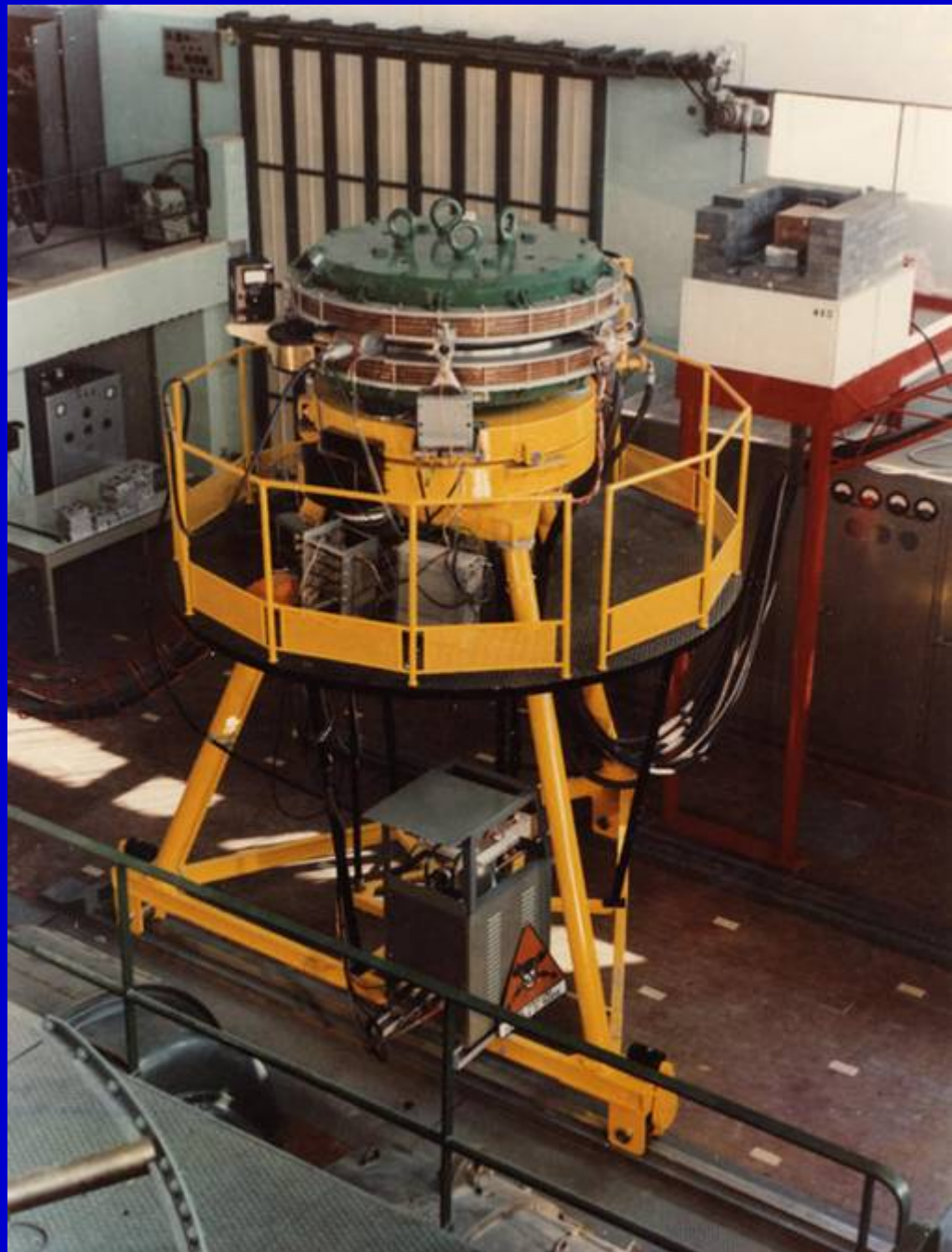

First Russian storage ring – electron-electron collider VEP-1 (1963, Novosibirsk).

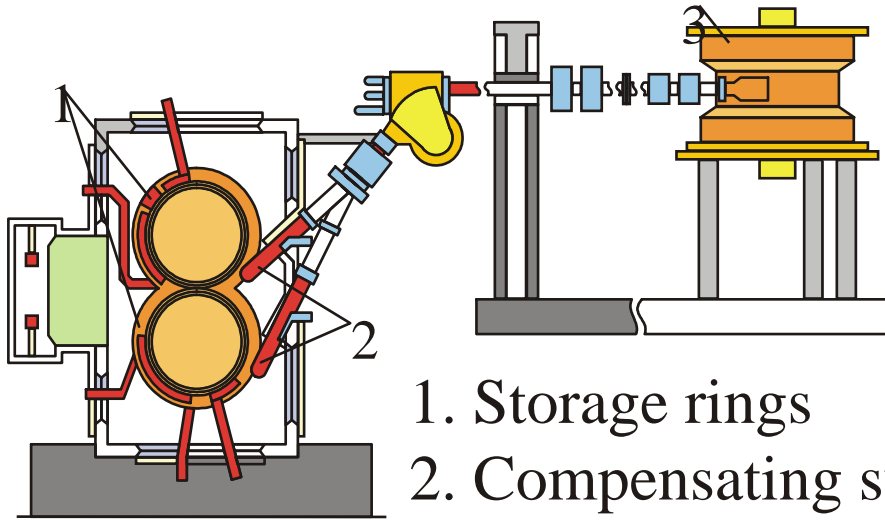

1. Storage rings
2. Compensating systems
3. Synchrotron B-2S

$E = 90 \text{ MeV} - 320 \text{ MeV (total)}$; $L = 5 \cdot 10^{27} \text{ cm}^{-2}\text{s}^{-1}$
Exps 1965-1967 :

- electron-electron elastic scattering
(in parallel to Princeton-Stanford Rings);
- double bremsstrahlung (first observation and study)

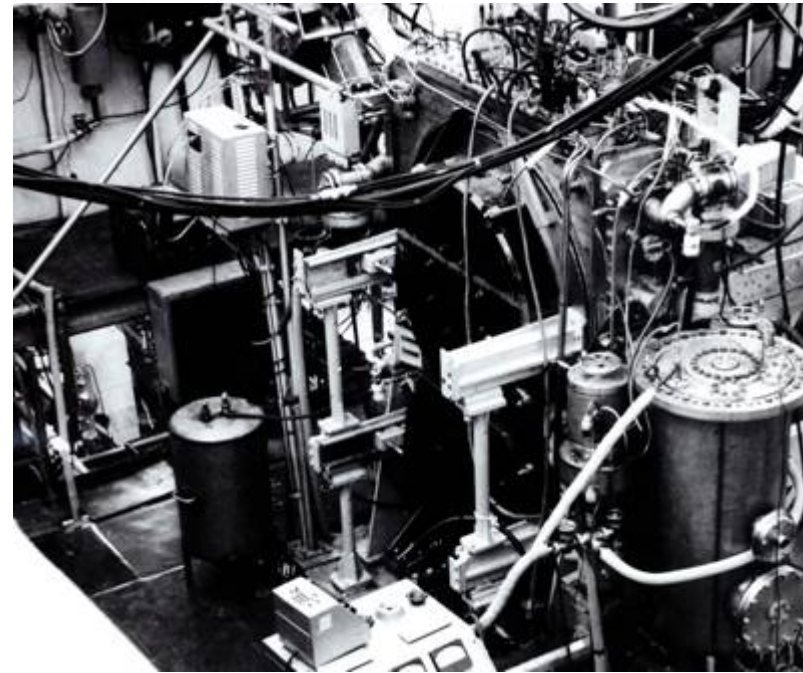

VEP-1
today is a monument



First electron-electron colliding beam experiments (1965)

Main purposes of the development of new SR sources:

1. Increase in the spectral brightness, which is the main user characteristic of radiation sources.
2. Increase in the radiation hardness.

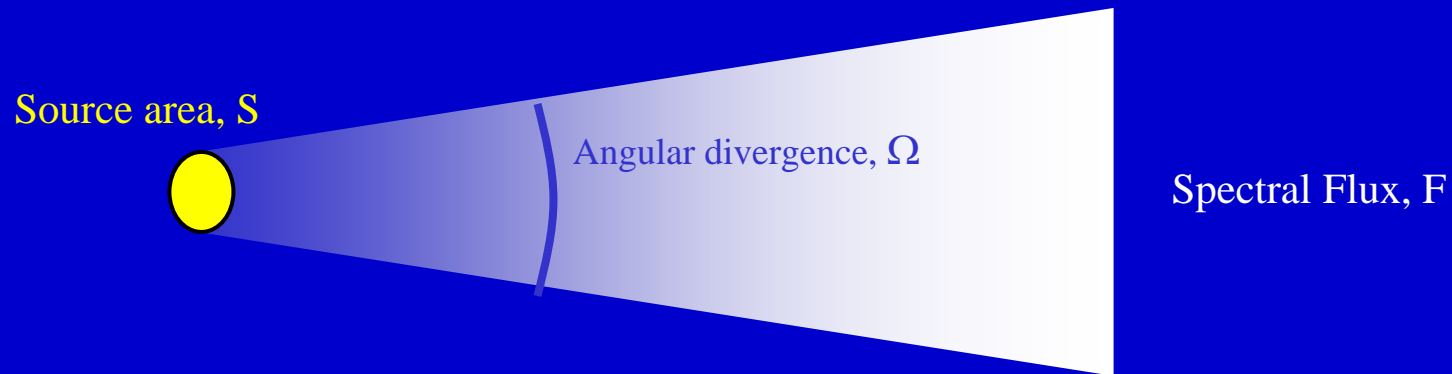

$$\text{Brightness} = \text{const } F/(S \cdot \Omega)$$

$$\lambda \sim 1/(E^2 B)$$

First generation SR sources: using cyclic electron synchrotrons and electron-positron storage rings with emittance $\varepsilon \sim 300$ nm in parasitic mode during high energy experiments

Bending magnets: $F \sim N_e$

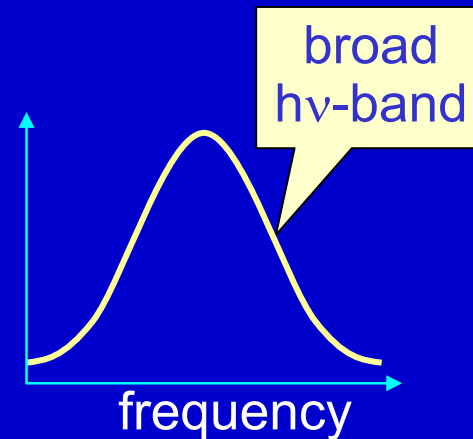
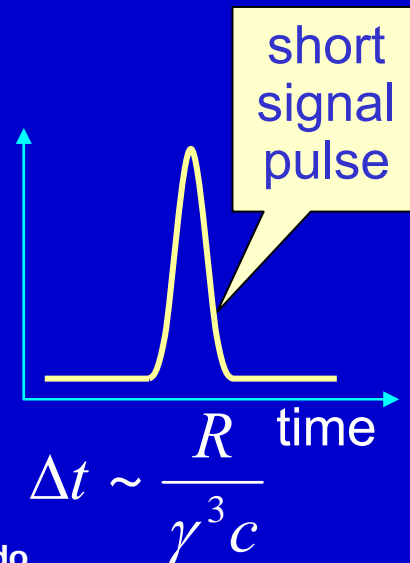
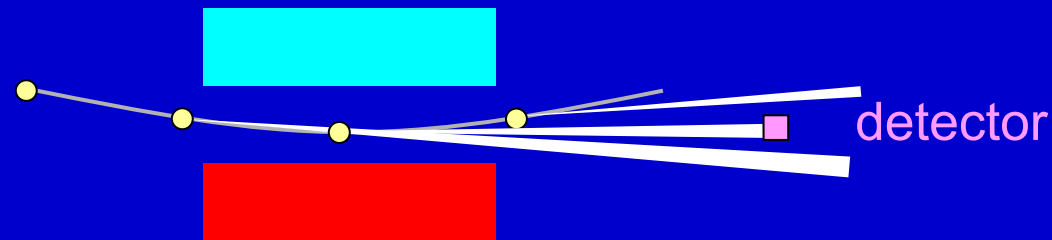

Second generation SR sources:

dedicated storage ring - synchrotron radiation sources
(low emittance $\varepsilon \sim 30$ nm, set of straight sections for wigglers)

Wigglers:

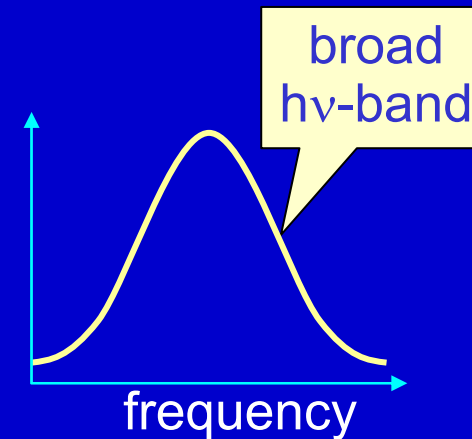
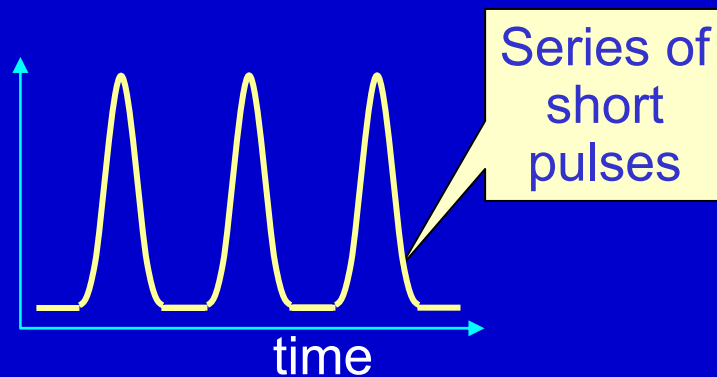
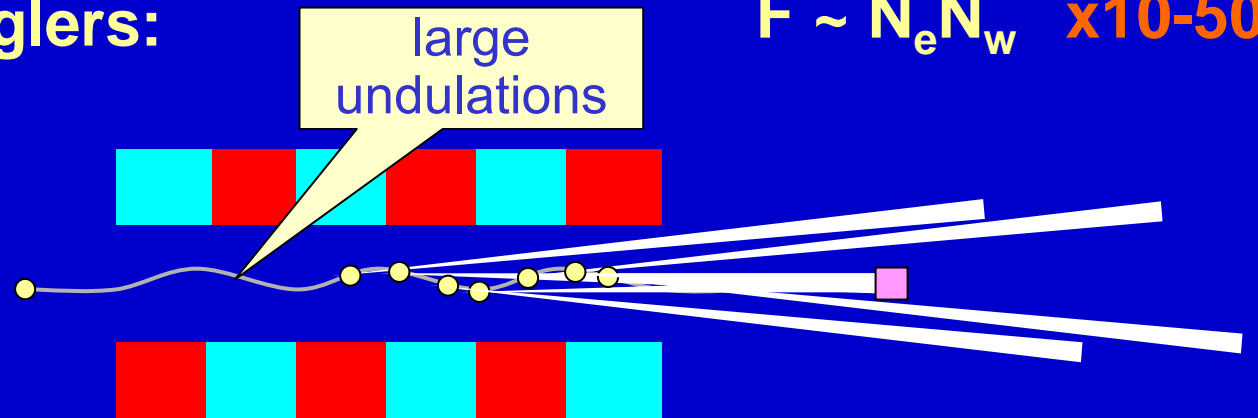

Third generation SR sources:

storage rings optimized for installation of undulators
(low emittance $\varepsilon \sim 3$ nm, set of long straight sections
for long undulators)

Undulators:

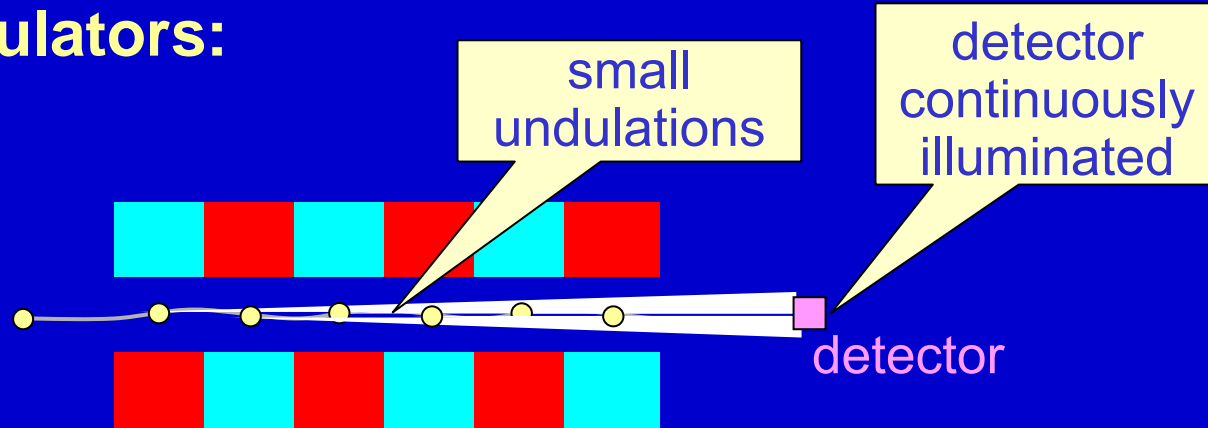

$$F \sim N_e N_u^2 \times 10^3 - 10^4$$

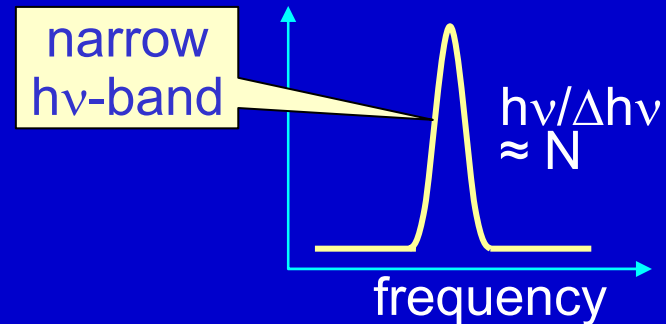
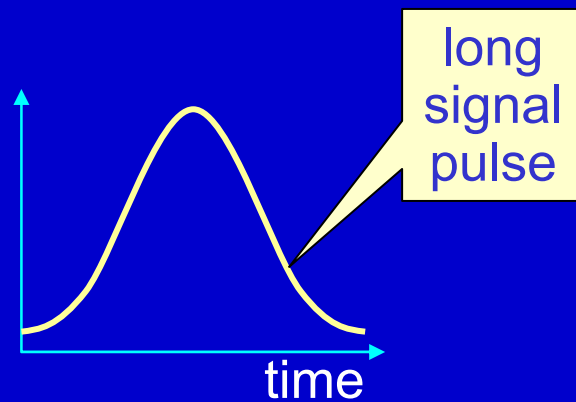

- Among the main elements of modern SR sources are undulators and wigglers - periodic magnetic structures, the use of which was first proposed in the work by V. Ginzburg in 1947; several years later, the first undulator was created and tested on the linear accelerator by Motz et al. in 1951.
- The first wiggler was created by K. Robinson in 1966.

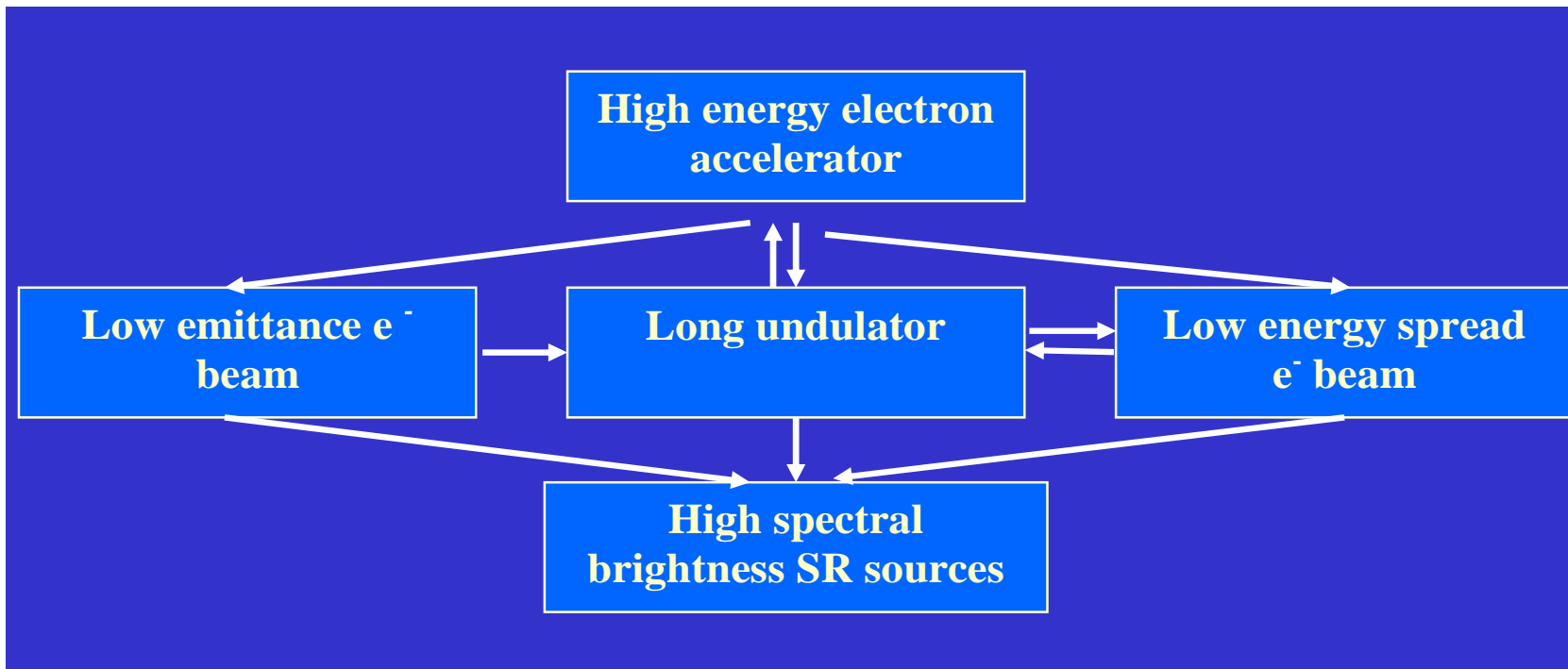

1980	$\varepsilon \sim 300 \text{ nmrad}$	$N_u \sim 10$	$\sigma_E/E \sim 10^{-3}$
1990	$\varepsilon \sim 30 \text{ nmrad}$	$N_u \sim 10^2$	$\sigma_E/E \sim 10^{-3}$
2000	$\varepsilon \sim 3 \text{ nmrad}$	$N_u \sim 10^3$	$\sigma_E/E \sim 10^{-3}$
2010	$\varepsilon \sim 1 \text{ nmrad}$	$N_u \sim 10^3$	$\sigma_E/E \sim 10^{-3}$

Storage rings

APS



SPring-8

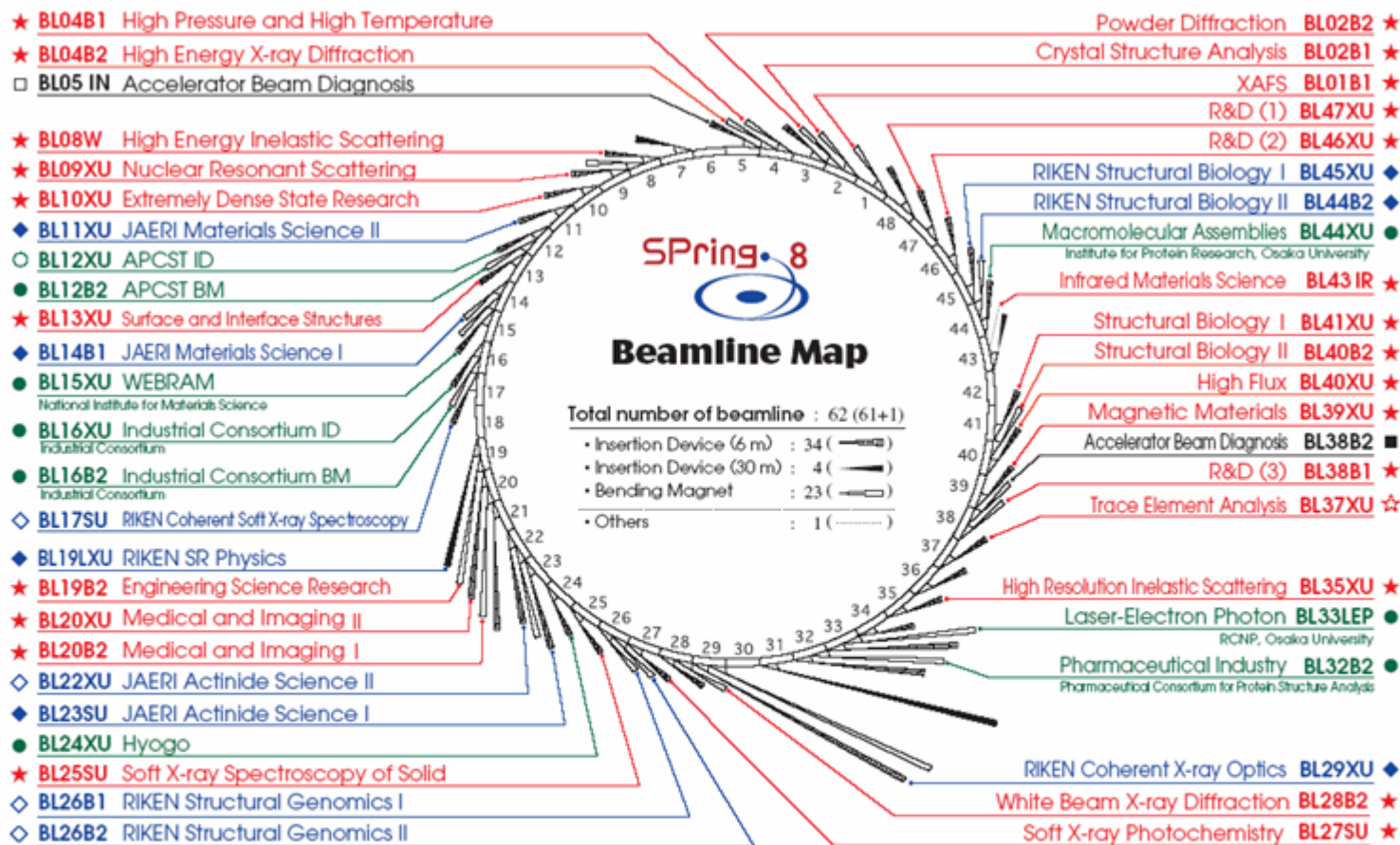
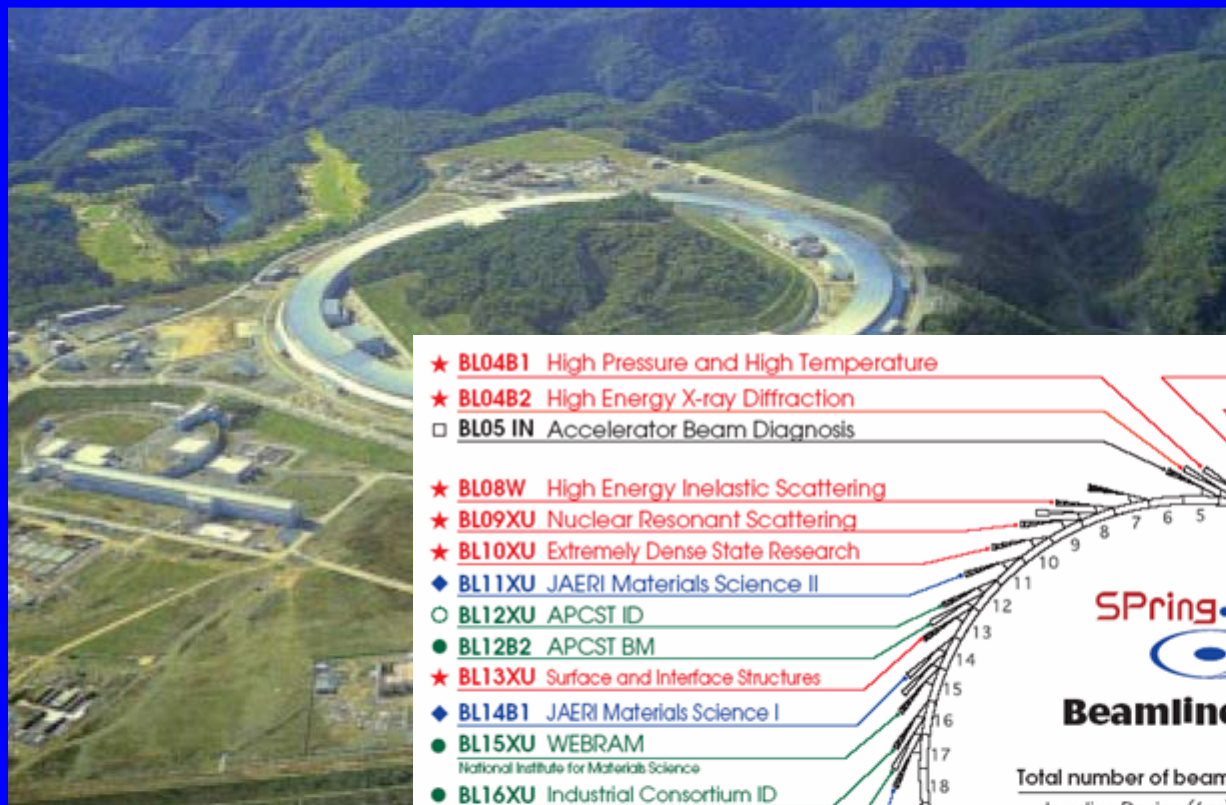

Steep rise in brightness/brilliance

(units: photons/mm²/s/mrad², 0.1% bandwidth)

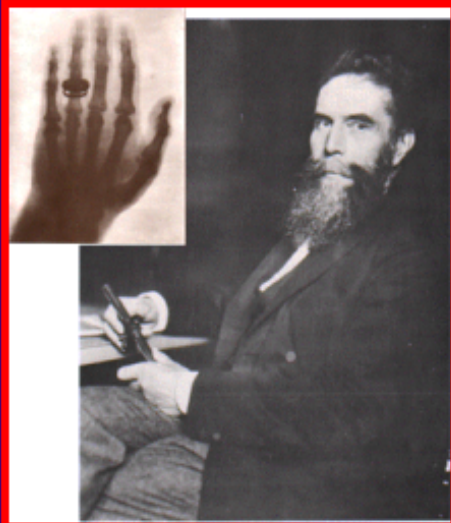
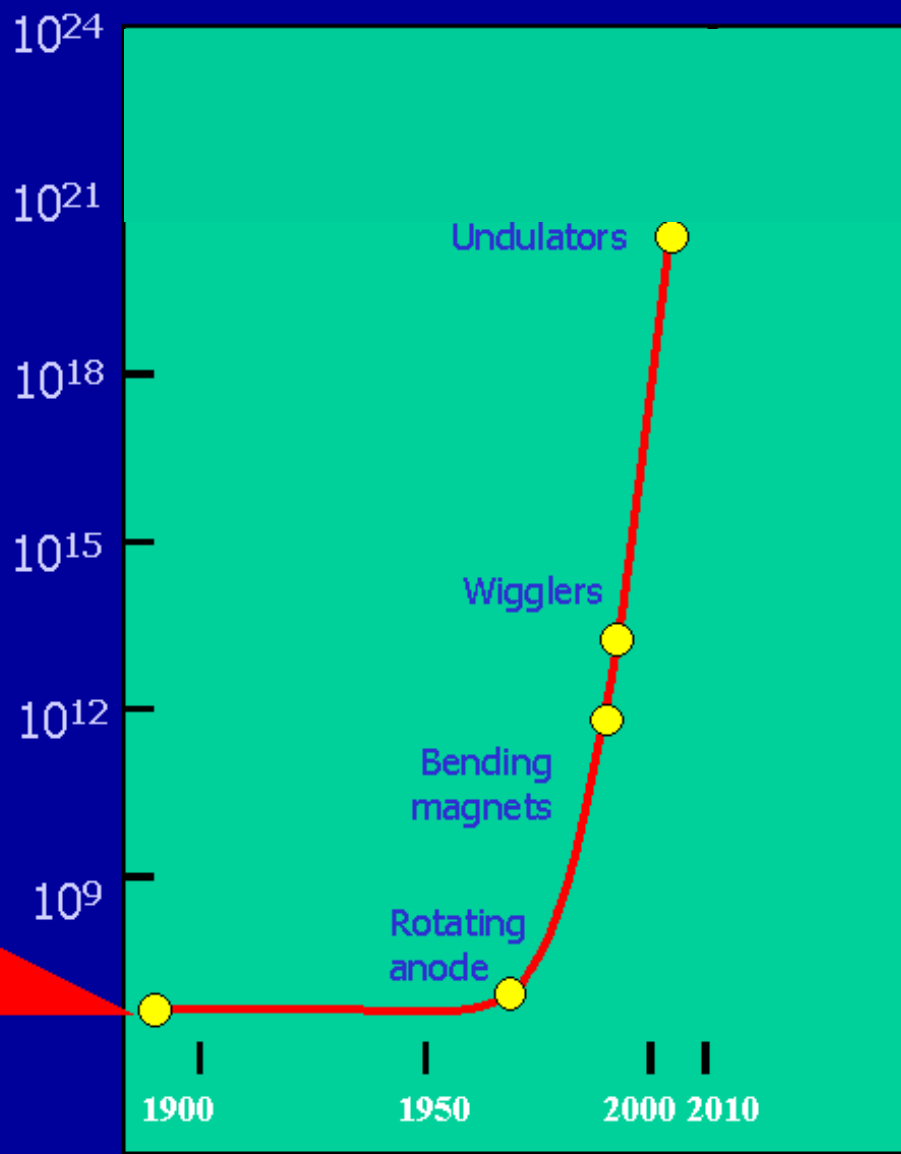

Spring-8



Siberia-2



VEPP-3

2. Requirements for the 4th generation SR sources

- The existing SR sources of the 3rd generation and those under construction (APS, ESRF, Spring-8, SLS, ELETTRA, DIAMOND, SOLEIL, PETRA-III, ALBA ...) are efficient factories for generation of the new knowledge, new technologies and new materials.
- In the last two decades, there have been active discussions on the development of the 4th generation SR sources. The world's physical community worked out the requirements to these sources and suggested several ways for the development of such sources.

List of requirements to the future generation of X-ray sources:

- ❑ full spatial coherence;
- ❑ the highest temporal coherence ($\Delta\lambda/\lambda < 10^{-4}$) without additional monochromatization;
- ❑ the averaged brightness of the sources should to exceed 10^{23} - 10^{24} photons $s^{-1}mm^{-2}mrad^{-2}(0.1\% \text{ bandwidth})^{-1}$;
- ❑ the full photon flux for the 4th generation sources should be at the level of the 3rd generation SR sources;
- ❑ high peak brightness of the order of 10^{33} photons $s^{-1}mm^{-2}mrad^{-2}(0.1\% \text{ bandwidth})^{-1}$ is important for some experiments;
- ❑ electron bunch length up to 1 ps; and if a specialized technique is used, the X-ray pulses become smaller than 100 fs;
- ❑ high long-term stability; generation of linear, left-right circular polarized radiation with fast switching of the polarization type and sign; constant heat load on chambers and optics, etc.
- ❑ multi-user operation.

Further reading

Scientific Needs for Future X-Ray Sources in the U.S.

A White Paper



Based on a study group co-chaired by Roger Falcone and Joachim Stöhr, and members: Uwe Bergmann, John Corlett, John Galayda, Jerry Hastings, Robert Hettel, Zahid Hussain, Jance Kirz, Bill McCurdy, Tor Raubenheimer, Fernando Sannibale, John Seeman, Z.-X. Shen, Robert Schoenlein, and Alexander Zholents.

Lawrence Berkeley National Laboratory
SLAC National Accelerator Laboratory

October 2008

Work supported in part by US Department of Energy contract DE-AC02-76SF00515

Ultrafast Sources and Science

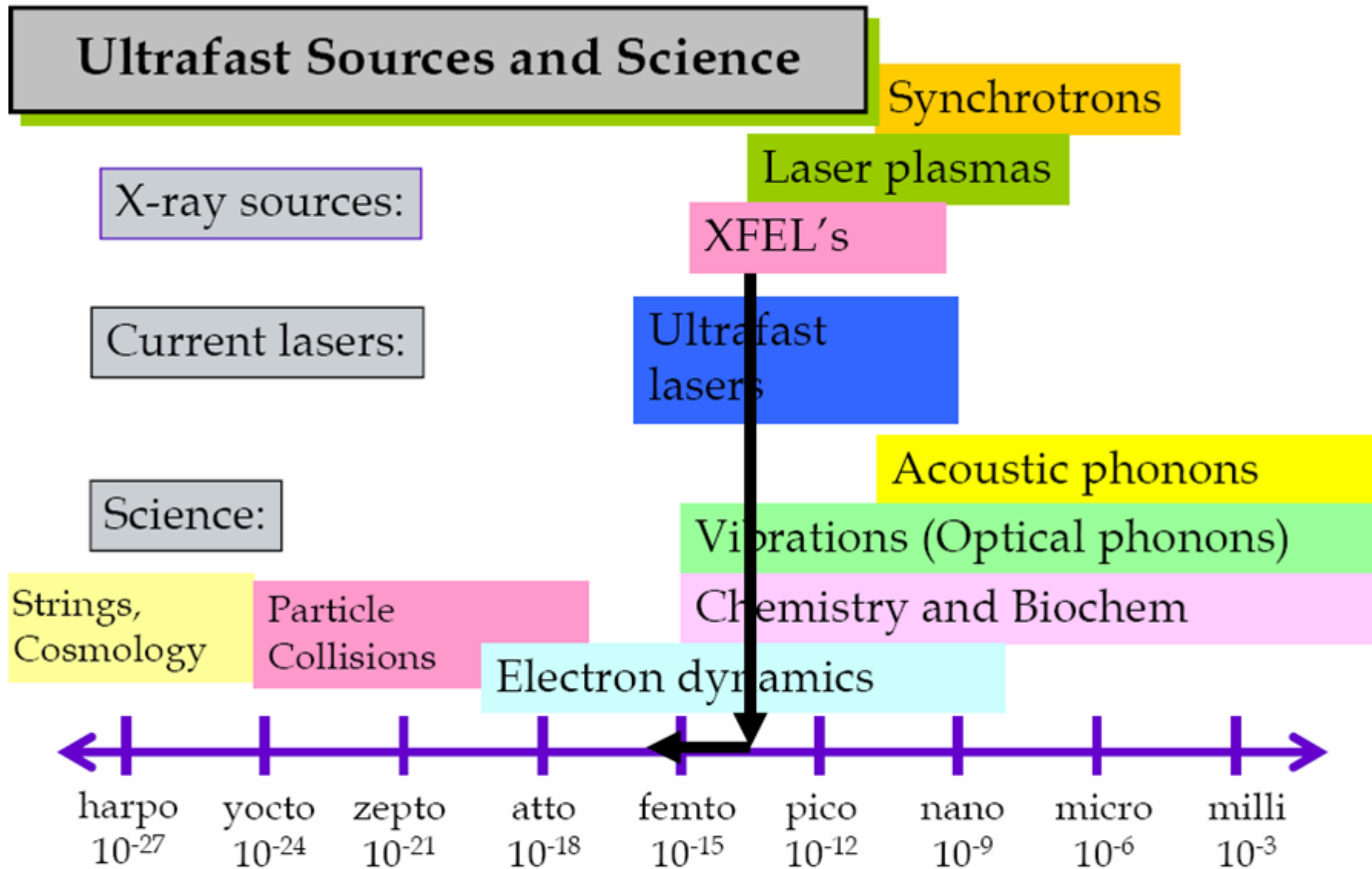

J. Hastings

Characteristic Times in Matter

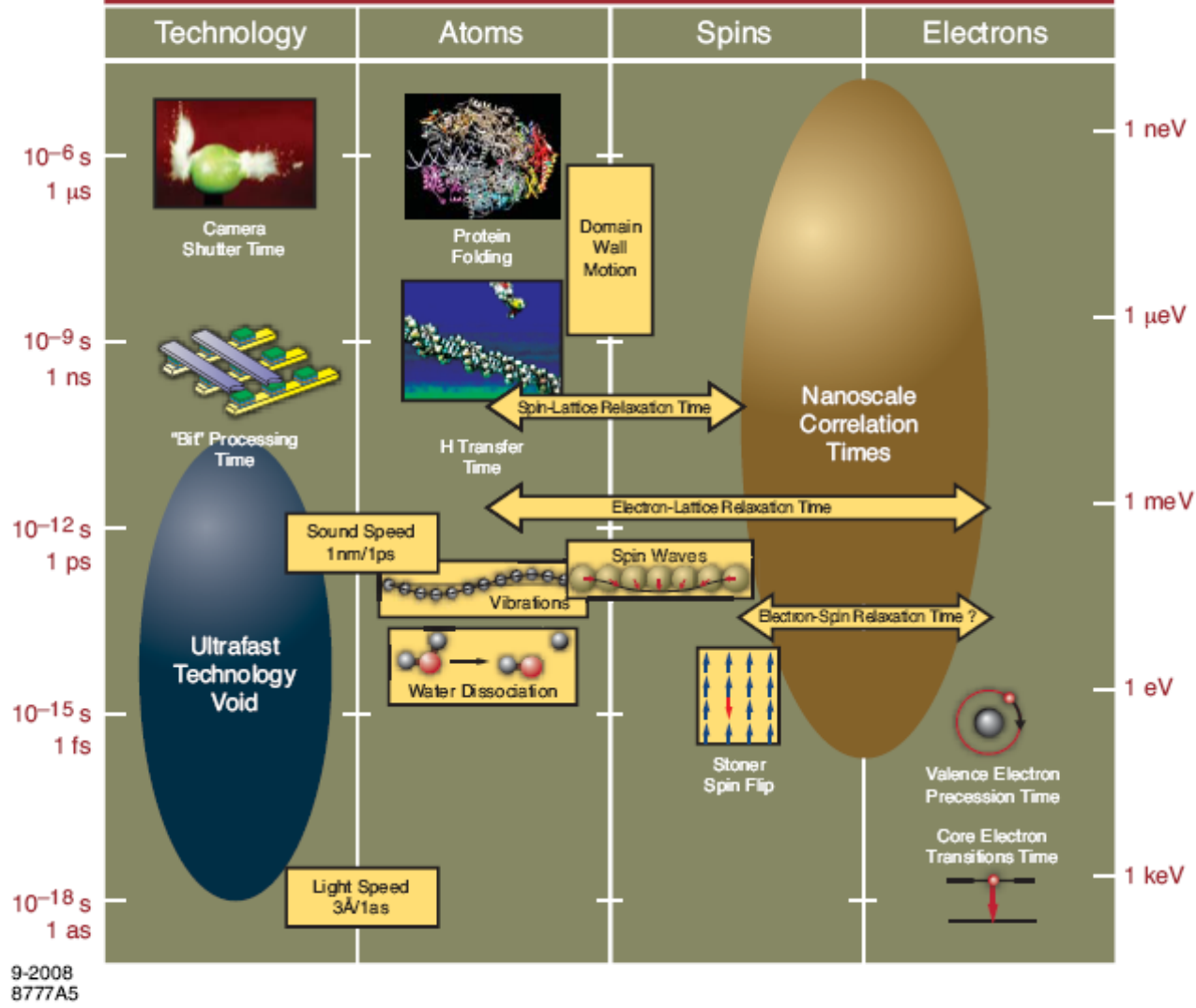

Figure 2.1. Illustration of our present knowledge about typical times involved in the interactions of atoms, electrons, and spins. On the right, we have indicated the corresponding quantum-mechanical interaction energies as estimated from the energy–time correlation $\Delta E \cdot \Delta t = \hbar \sim 4 \text{ fs} \cdot \text{eV}$.

- During the last 30 years, the brightness of the X-ray SR sources based on storage rings has increased by a factor of 10^9 .
- Nevertheless, on the modern sources, the flux of coherent quanta is only 10^{-3} of the total flux. Therefore, in spite of successful demonstrating X-ray holography, it has not become an efficient technique for structural studies of real objects of mostly noncrystalline structure. Even for crystalline structures, the speckle spectroscopy, which is accessible only in coherent light, is very important.
- Therefore, obtaining a fully spatially coherent flux of quanta with a full photon flux at the level of the 3rd generation SR sources is the most important requirement to the 4th generation SR sources.
- A possibility of using undulator radiation with a monochromaticity of $10^{-3} \div 10^{-4}$ without monochromator, which as a rule spoils the beam spatial coherence, is also of great importance.

An important task for the future generation of X-ray sources is to provide:

- full spatial coherence;
- as high as possible temporal coherence.

In this case, the increase in spectral brightness takes place without rise in the total photon flux for minimization of problems with X-ray optics and sample degradation.

$$B_{\lambda} = \frac{N_{ph}}{\Delta t} \cdot \frac{1}{\Delta S \cdot \Delta \Omega} \cdot \frac{1}{\Delta \lambda / \lambda}$$

Diffraction limit of the optical source phase volume
("mode" volume)

$$(\Delta S \cdot \Delta \Omega)_{\min} = \frac{\lambda^2}{4}, \text{ Gaussian beam.}$$

The electron beam emittance must be rather low:

$$\varepsilon_x = \sigma_x \cdot \sigma_{x'} \leq \frac{\lambda}{4\pi}$$

In this case, the source provides full spatial coherence of radiation:

$$\dot{N}_{coh} = B_\lambda \cdot \lambda^2 \cdot \frac{\Delta\lambda}{\lambda} = \frac{N_{ph}}{\Delta t}$$

- The temporal coherence of source is determined by the radiation bandwidth:

$$l_{coh} = \frac{\lambda^2}{2\Delta\lambda}$$

- The linewidth of undulator radiation is determined by the number of undulator periods and energy spread of electron beam:

$$\frac{\Delta\lambda}{\lambda} \sim \frac{1}{N_u} \text{ for } N_u < \frac{1}{2\pi} \left(\frac{\sigma_E}{E} \right)^{-1}$$

- The fundamental limit of energy spread is determined by the quantum fluctuation of undulator radiation

$$\left(\frac{\sigma_E}{E} \right)^2 \sim 180 \cdot r_0 \cdot \lambda_c \cdot \gamma^2 \cdot \left(\frac{K}{\lambda_u} \right)^3 Z \text{ ,}$$

r_0, λ_c are the classical radius and Compton wavelength of electron, K is the undulator parameter, Z is the distance from the undulator entrance.

Main ways of creation of 4th generation X-ray sources:

1. Decreasing the electron beam emittance down to the diffraction limit:

$$\varepsilon_x < \frac{\lambda}{4\pi} \sim 10^{-11} \text{ mrad} \left(\lambda \sim 1 \text{ \AA} \right)$$

2. Decreasing the electron beam energy spread down to the fundamental limit due to the quantum fluctuation of undulator radiation ($\sigma_E/E < 10^{-4}$);
3. Using a long undulator with a number of periods determined by the fundamental limit due to the quantum fluctuation of undulator radiation ($N_u \sim 10^4$).

Three different kinds of SR sources have been considered recent years:

- long undulators installed on advanced storage rings;
- long undulators installed on linear electron accelerators;
- long undulators installed on recirculating accelerator-recuperator sources.

3. Comparison of storage rings, linacs and recirculating accelerators-recuperators as SR sources

Advantages of storage rings:

- a) high average reactive power in beam (*for $E = 8 \text{ GeV}$; $I = 1.5 \text{ A}$, $P_{\text{reactive}} = 12 \text{ GW}$);*
- b) long life time ($\sim 10 - 100 \text{ h}$), small losses of high-energy particles per time unit, and, correspondingly, low radiation background and absence of induced radioactivity;
- c) a lot of SR beam lines in simultaneous operation (up to 50 on a storage ring) – multi-user operation.

Disadvantages of storage rings:

The emittance and energy spread of electron beam depends on the equilibrium between radiation damping and diffusion caused by the quantum fluctuations of SR and intrabeam scattering in case of high-density beams.

There is no way to decrease the emittance in a storage ring
 $\varepsilon_x < 10^{-10}$ mrad and energy spread $\sigma_e/E < 10^{-3}$
(quantum fluctuation of SR, intrabeam scattering).

Advantages and disadvantages of linacs:

- Advantages of linacs: the normalized emittance ε_n can be conserved during the acceleration process. With a good injector with $\varepsilon_n < 10^{-7}$ m·rad, adiabatic damping at energy $E > 5$ GeV allows emittance $\varepsilon_{x,z} \sim 10^{-11}$ mrad and energy spread $\delta_E / E \sim 10^{-4}$.
- Main disadvantages of linacs: low average current (10^{-7} A) in case of pulsed normal-conductance linacs. If current is increased in case of superconducting linacs, radiation hazard is a very serious problem.

Why should the 4th generation SR sources use the accelerators-recuperators?

All the requirements to X-ray radiation sources of the 4th generation cannot be met using only one kind of a source.

The high peak brightness and femtosecond duration of radiation pulses can be attained at the linac based X-ray SASE FEL with a high pulse current ($I_p > 1$ kA).

All the remaining requirements are more easily and cheaply realized with the use of radiation from long undulators installed on the accelerator-recirculator with energy recovery.

Of course, energy recovery will also be effective for CW SASE XFEL based on SC linac.

Layout of the SR source based on one-pass accelerator-recuperator

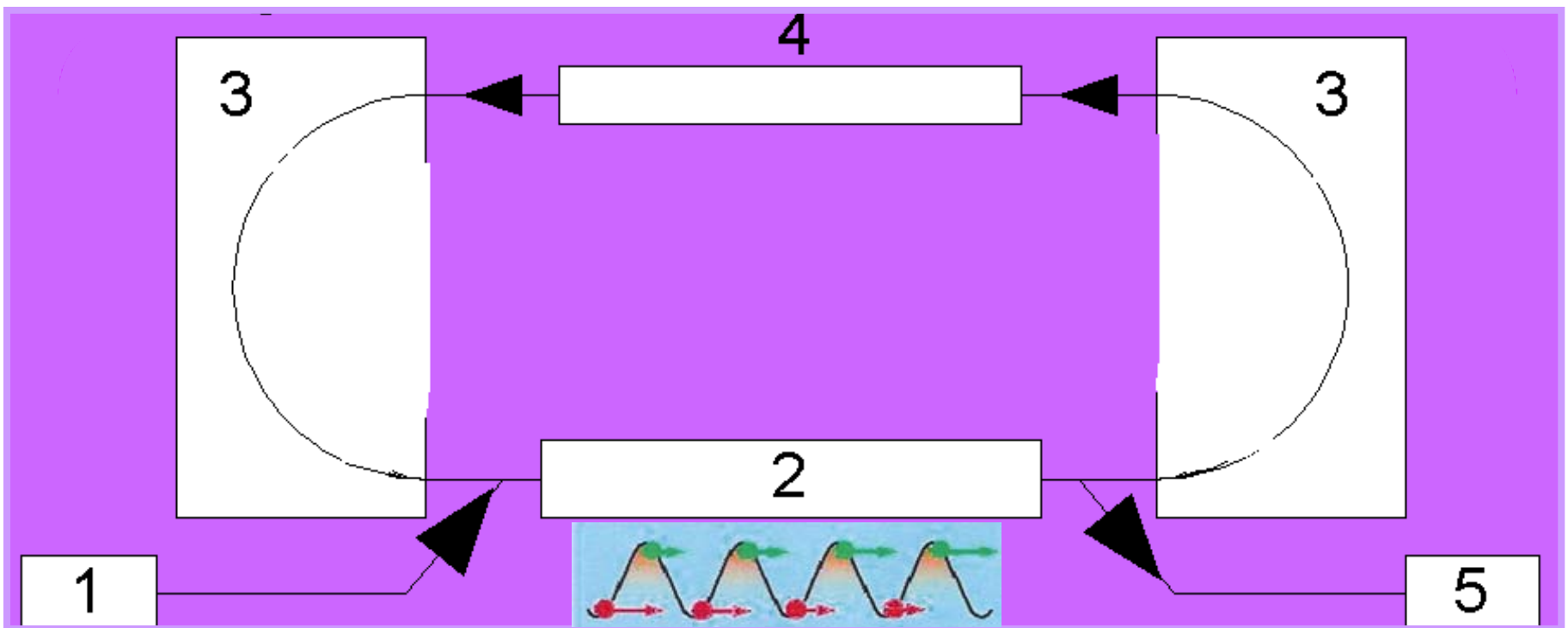

1 - injector, 2 - RF accelerating structure, 3 - 180-degree bends,
4 - undulator, 5 - beam dump

Layout of the SR source based on four-pass accelerator-recuperator

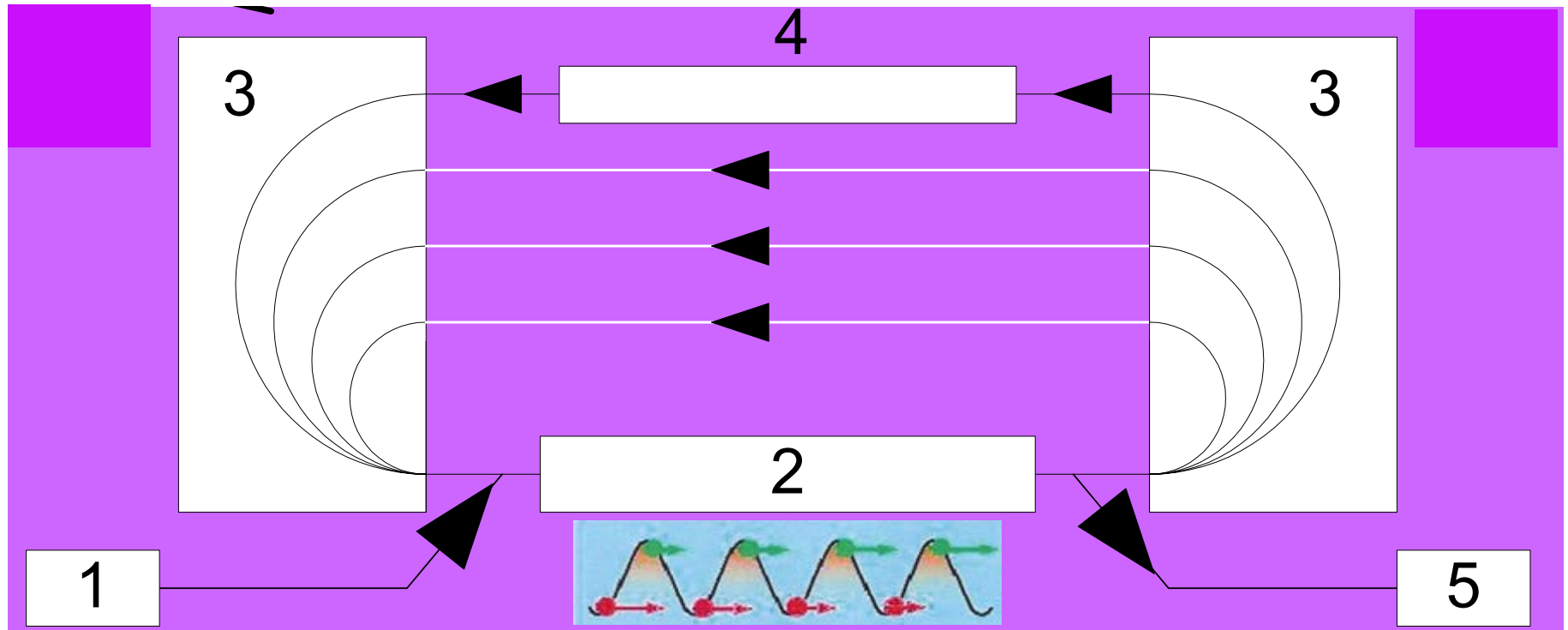

1 - injector, 2 - RF accelerating structure, 3 - 180-degree bends,
4 - undulator, 5 - beam dump.

- In accelerators-recirculators, the normalized emittance ε_n can be conserved during the acceleration process. With a good injector with $\varepsilon_n < 10^{-7}$ m·rad, adiabatic damping at energy $E > 5$ GeV allows emittance $\varepsilon_{x,z} \sim 10^{-11}$ mrad and energy spread $\delta_E / E \sim 10^{-4}$.
- In the accelerators-recirculators, the time of acceleration is shorter compared with the time of radiation damping in storage rings ($10^3 \div 10^4$ times). So the diffusion processes cannot spoil the electron beam emittance and energy spread.

The users of synchrotron radiation will perceive the radiation from undulators like radiation from a storage ring with the only difference that each time new ('fresh') electrons are used with a small emittance $\varepsilon_{\min} \sim 10^{-2}$ nm rad and energy spread $\sigma_E/E \sim 10^{-4}$.

❑ Main motivation for accelerator-recuperator:

combination of the advantages of storage ring (high reactive power in beam and low radiation hazard) and linac (normalized emittance and energy spread can be conserved during the acceleration process);

radiation hazard can be eliminated owing to energy recovery and the cost of construction will be reduced.

❑ Main motivation for multi-pass accelerator-recuperator:

the cost of the accelerating RF system can be reduced owing to multipass acceleration.

History of physical proposals based on the using of the accelerator – recuperator:

- M. Tigner (1965): linear e-e⁻ collider using SRF linacs with energy recovery (not realized) (M. Tigner, Nuovo Cimento, **37**, (1965)).
- G. Budker (1968): electron coolers using DC electron accelerators; first demonstration of an energy recovery cooler was made in Novosibirsk (1974); now all electron coolers (more than 10) use energy recuperation.
- A. Skrinsky, N. Vinokurov (1979): increasing the efficiency and power of the FEL by means of ERL; the first demonstration of energy recovery SRF linac was made at Stanford University (1986); (T. Smith e. a., NIMA, **259** (1987). ERL FELs in operation now: in Jefferson Laboratory FEL (USA), Budker Institute of Nuclear Physics FEL (Russia), JAERI FEL (Japan).

- Kulipanov G., Skrinsky A., Vinokurov N. (1997): a fully spatially coherent X-ray source using accelerators-recirculators with energy recuperation instead of electron storage rings (SRI-97)

See: [1] *MARS - recirculator-based diffraction limited X-ray source. // Budker INP preprint No 97-103 (1997);*

[2] *Kulipanov G., Skrinsky A., Vinokurov N. Synchrotron light sources and recent development of accelerator technology. // J. of Synchrotron Radiation –1998 V.5 pt.3 P.176).*

- MARS, a recuperator-based diffraction-limited X-ray source, was presented and discussed at the ICFA workshop on future light sources (ANL, USA, July 1999) and SRI-2000 (Berlin), "ERLSYN-2002" (Erlangen, Germany, 2002), "SR-2004" (Novosibirsk, Russia, 2004); "RUPAC-2005" (Dubna, Russia, 2005); "Nano-Beam 2005" (Kyoto, Japan, 2005).

- After SRI-2000, the idea of using the accelerators-recuperators for creation of the 4th generation of SR sources has been actively discussed at Jefferson Lab, Cornell Uni., BNL, LBL, Erlangen Uni., Daresbury Lab., KEK.

4. History of recirculating accelerators, accelerators-recuperators and development of the SC technology.

- Recirculating accelerators with multiple passing of the accelerating sections and independent magnetic transport system for each pass – basis of the projects of multi-pass and one-pass accelerator-recuperator light sources.
- Creation of microtrons, racetrack microtrons, and cascaded race-track microtrons was a very important step for understanding problems of recirculating accelerators.

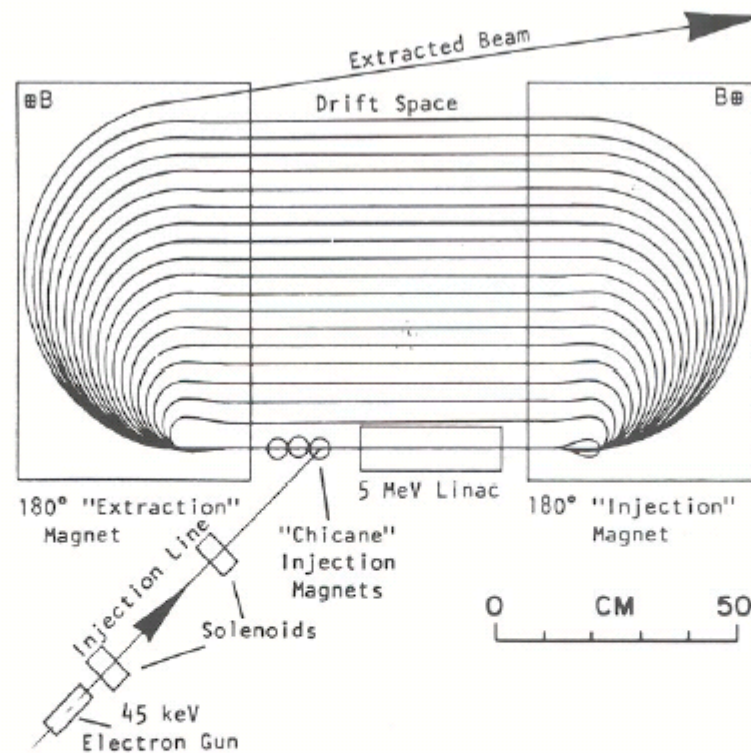

Figure 5.8 Schematic layout of the race-track microtron injector for the storage ring Aladdin at the Synchrotron Radiation Center of the University of Wisconsin (Green *et al.*, 1981; © 1981 IEEE)



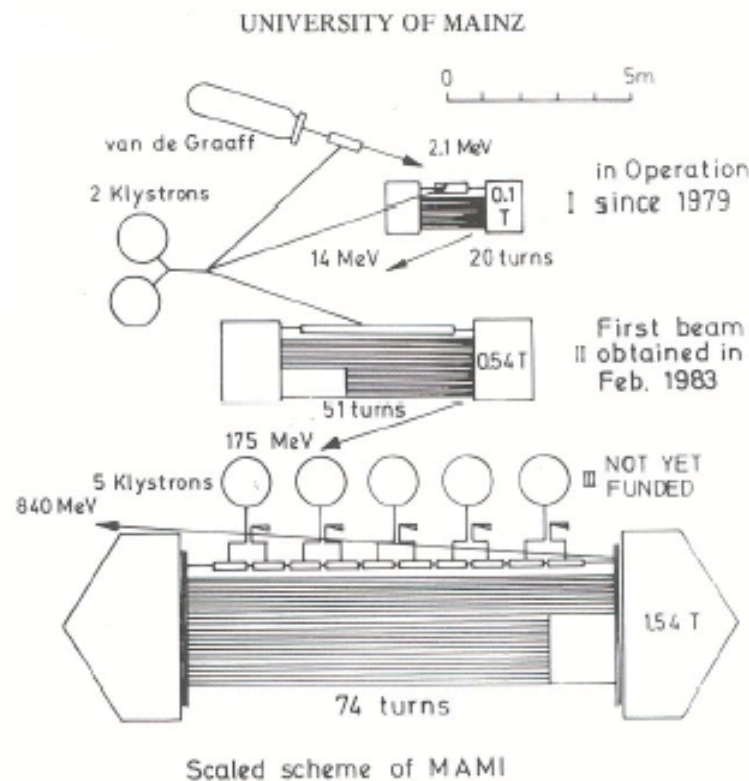

Figure 5.5 Schematic layout of the University of Mainz three-stage cascaded race-track microtron, MAMI (Herminghaus *et al.*, 1983; © 1983 IEEE)



Thomas Jefferson National Accelerator Facility

USPAS Recirculated and Energy Recovered Linacs

3 March 2005

Operated by the Southeastern Universities Research Association for the U. S. Department of Energy

The Wuppertal/Darmstadt “Rezyklotron”

- The “Rezyklotron” incorporates a superconducting linac at 3 GHz.
- Beam injection energy = 11 MeV, variable extraction energy up to 130 MeV, beam current 20 μA , 100% duty factor. Energy resolution = 2×10^{-4} .
- Two orbits designed with 180° **isochronous and achromatic bends** and two quadrupole doublets and two triplets in the backleg.
- **Isochronous beam optics**

Phase oscillations do not occur and energy resolution is determined primarily by second order effects in the linac.

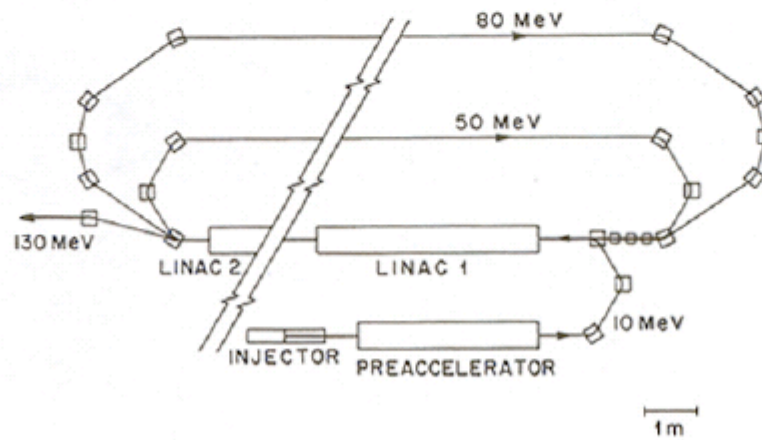

The SCA/FEL Energy Recovery Experiment

- Same-cell energy recovery was first demonstrated in the SCA/FEL in July 1986
- Beam was injected at 5 MeV into a ~50 MeV linac (up to 95 MeV in 2 passes), 150 μ A average current (12.5 pC per bunch at 11.8 MHz)
- The previous recirculation system (SCR, 1982) was unsuccessful in preserving the peak current required for lasing and was replaced by a doubly achromatic single-turn recirculation line.
- All energy was recovered. FEL was not in place.

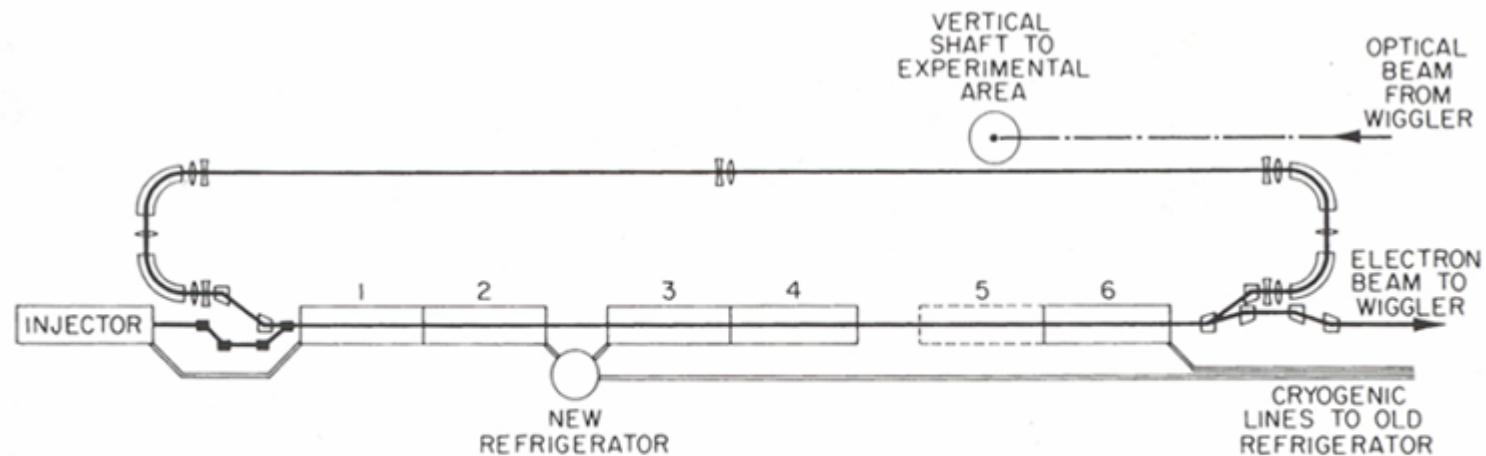

Superconducting RF technology

- The superconducting RF technology was developed by Cornell University, KEK, CERN, Jefferson Laboratory, and DESY.
- The CEBAF at Jefferson Laboratory was the first in the world large scale implementation of the SRF technology using multipass beam recirculation.
- The CEBAF accelerator is a 5-pass recirculating SRF linac with CW beams up to 200 μA , the full energy of nearly 6 GeV, the geometric emittance $\varepsilon < 10^{-9}$ m·rad and a relative energy spread of a few 10^{-5} .

CEBAF Accelerator Layout*

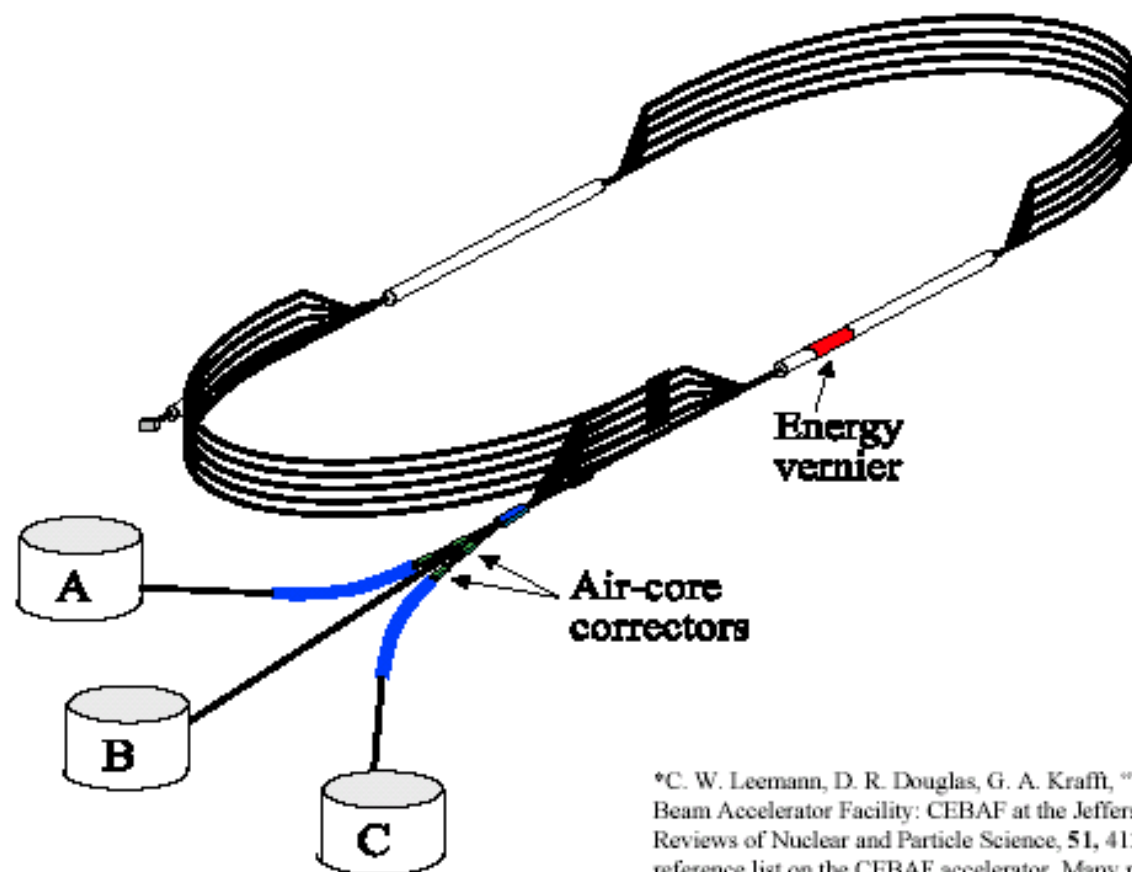

*C. W. Leemann, D. R. Douglas, G. A. Krafft, "The Continuous Electron Beam Accelerator Facility: CEBAF at the Jefferson Laboratory", Annual Reviews of Nuclear and Particle Science, 51, 413-50 (2001) has a long reference list on the CEBAF accelerator. Many references on Energy Recovered Linacs may be found in a recent ICFA Beam Dynamics Newsletter, #26, Dec. 2001: http://icfa-usa/archive/newsletter/icfa_bd_nl_26.pdf



Thomas Jefferson National Accelerator Facility

Recirculating and Energy Recovering Linacs

29 June 2005

Operated by the Southeastern Universities Research Association for the U. S. Department of Energy

5. Operating FELs based on low-energy
accelerators-recuperators

JLab 10kW IR FEL and 1 kW UV FEL

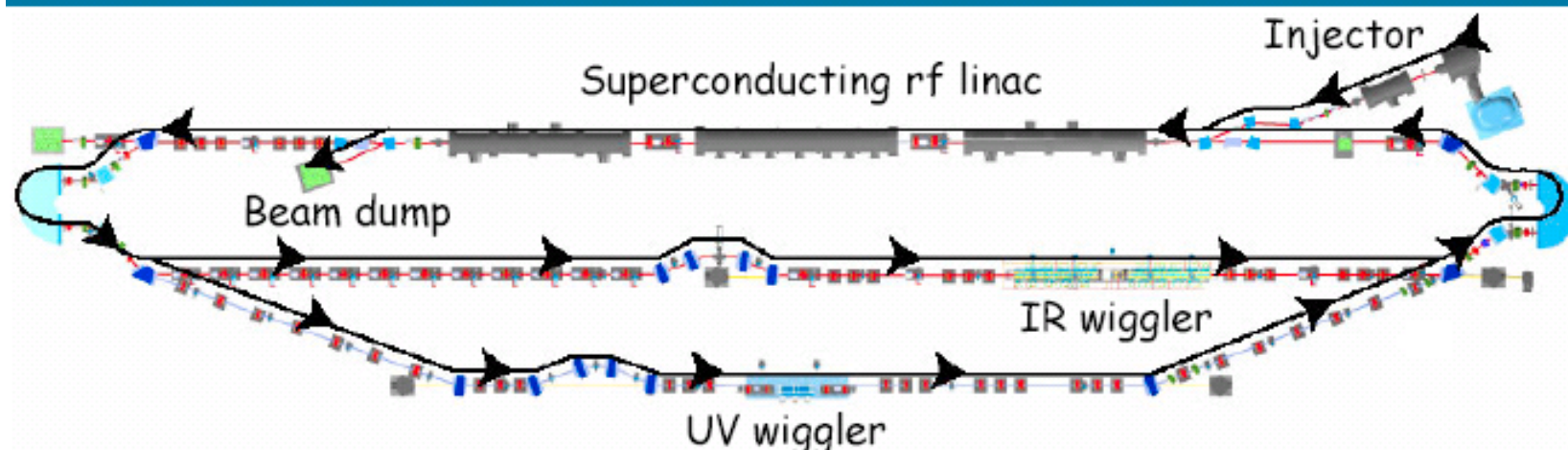

Output Light Parameters	IR	UV
Wavelength range (microns)	1.5 - 14	0.25 - 1
Bunch Length (FWHM psec)	0.2 - 2	0.2 - 2
Laser power / pulse (microJoules)	100 - 300	25
Laser power (kW)	>10	> 1
Rep. Rate (cw operation, MHz)	4.7 - 75	4.7 - 75

Electron Beam Parameters	IR	UV
Energy (MeV)	80-200	200
Accelerator frequency (MHz)	1500	1500
Charge per bunch (pC)	135	135
Average current (mA)	10	5
Peak Current (A)	270	270
Beam Power (kW)	2000	1000
Energy Spread (%)	0.50	0.13
Normalized emittance (mm-mrad)	<30	<11
Induced energy spread (full)	10%	5%



Thomas Jefferson National Accelerator Facility

Page 9



JAERI ERL-FEL

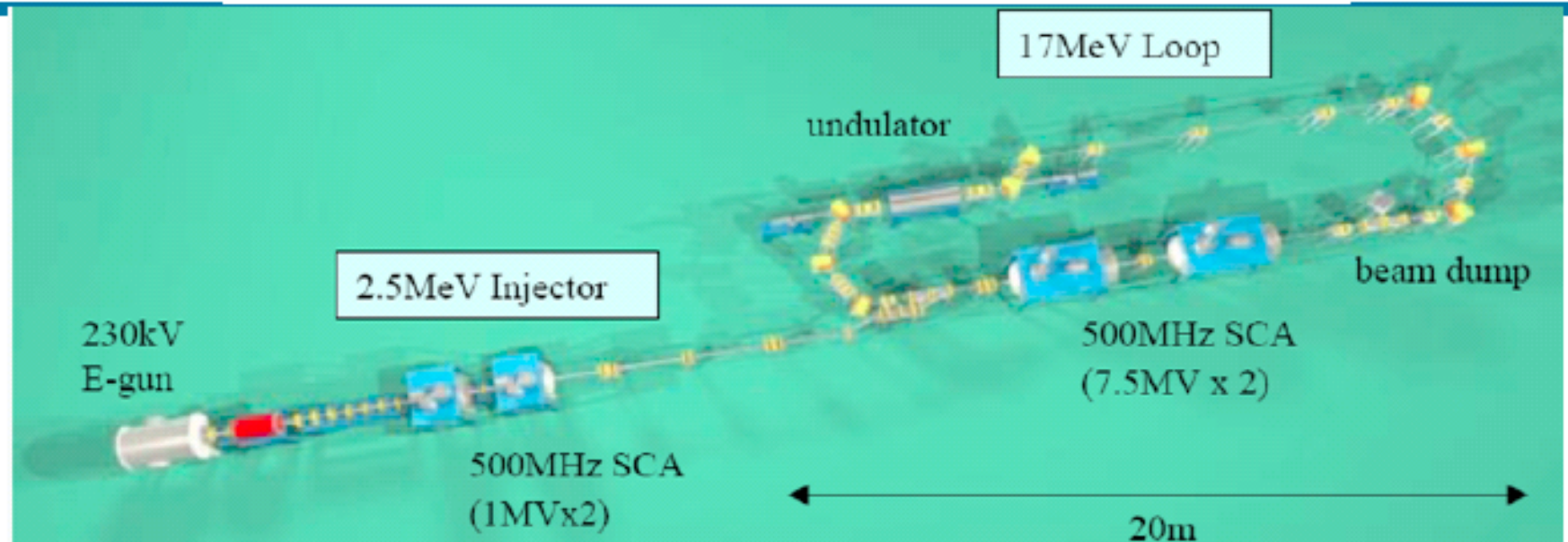

Output Light Parameters	Achieved	Goal
Wavelength range (microns)	22	22
Bunch Length (FWHM psec)	15	6
Laser power / pulse (microJoules)	10	120
Laser power (kW)	0.1	10
Rep. Rate (MHz)	10.4	83.2
Macropulse format	10ms 10Hz	CW

Electron Beam Parameters	Achieved	Goal
Energy (MeV)	17	16.4
Accelerator frequency (MHz)	500	500
Charge per bunch (pC)	500	500
Average current (mA)	5	40
Peak Current (A)	33	83
Beam Power (kW)	85	656
Energy Spread (%)	~0.5	~0.5
Normalized emittance (mm-mrad)	~40	~40
Induced energy spread (full)	~3%	~3%



Novosibirsk FEL (NovoFEL) as prototype of MARS

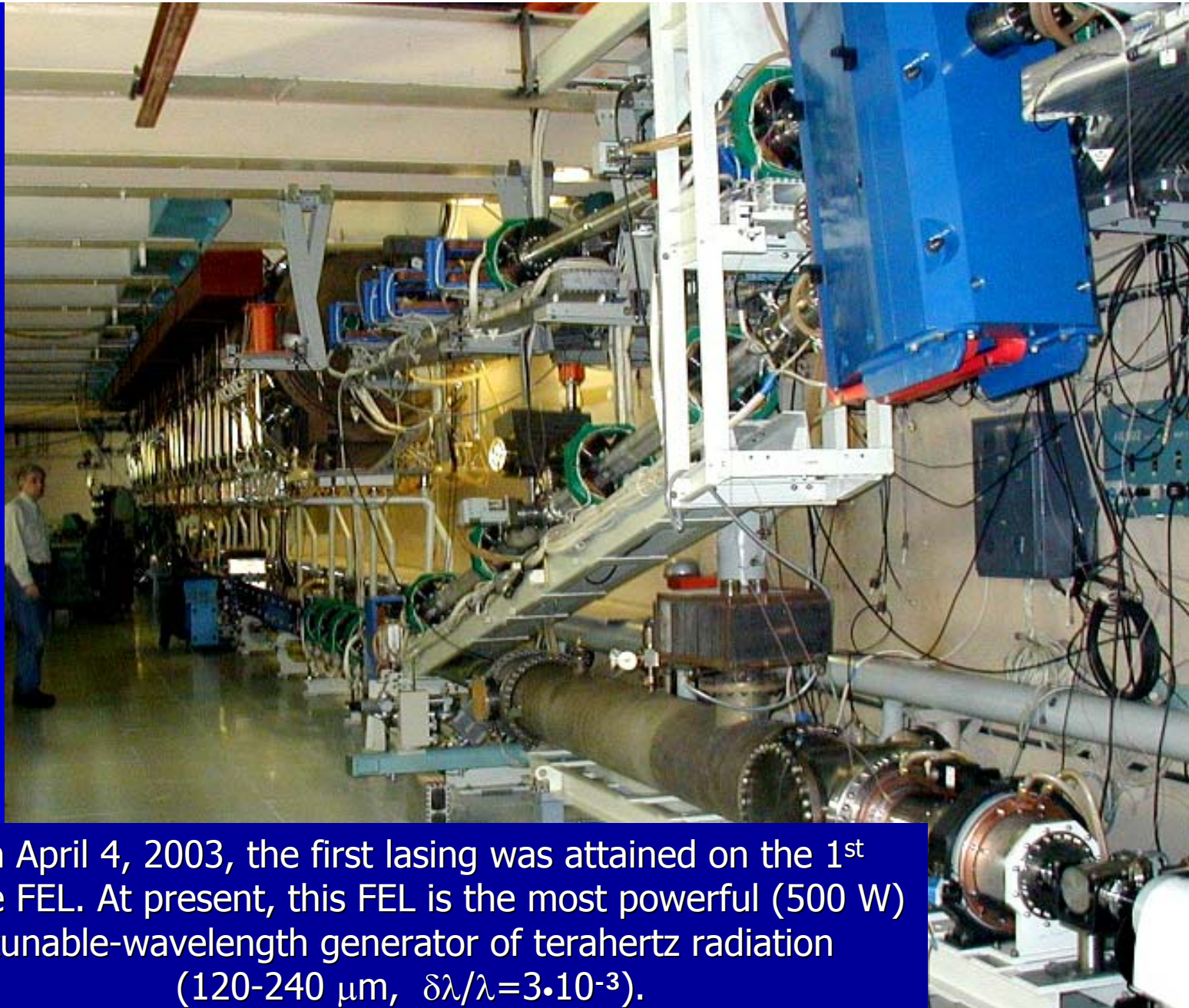

On April 4, 2003, the first lasing was attained on the 1st stage FEL. At present, this FEL is the most powerful (500 W) tunable-wavelength generator of terahertz radiation (120-240 μm , $\delta\lambda/\lambda=3\cdot 10^{-3}$).

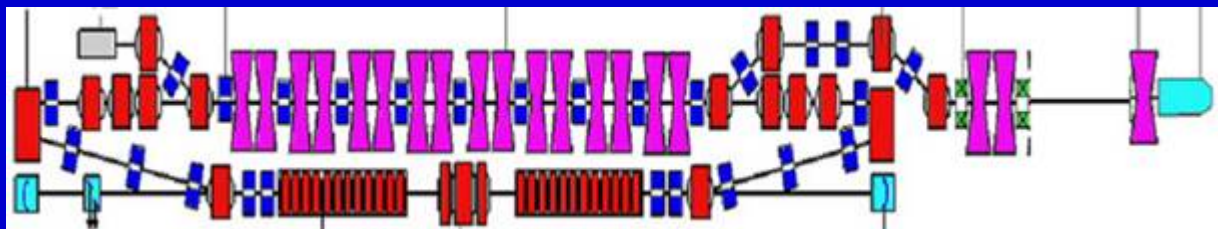

The scheme and views of the 1st stage Novosibirsk accelerator-recuperator and FEL

The 2nd and 3rd stages of Novosibirsk FEL placed in the horizontal plane (prototype of MARS)

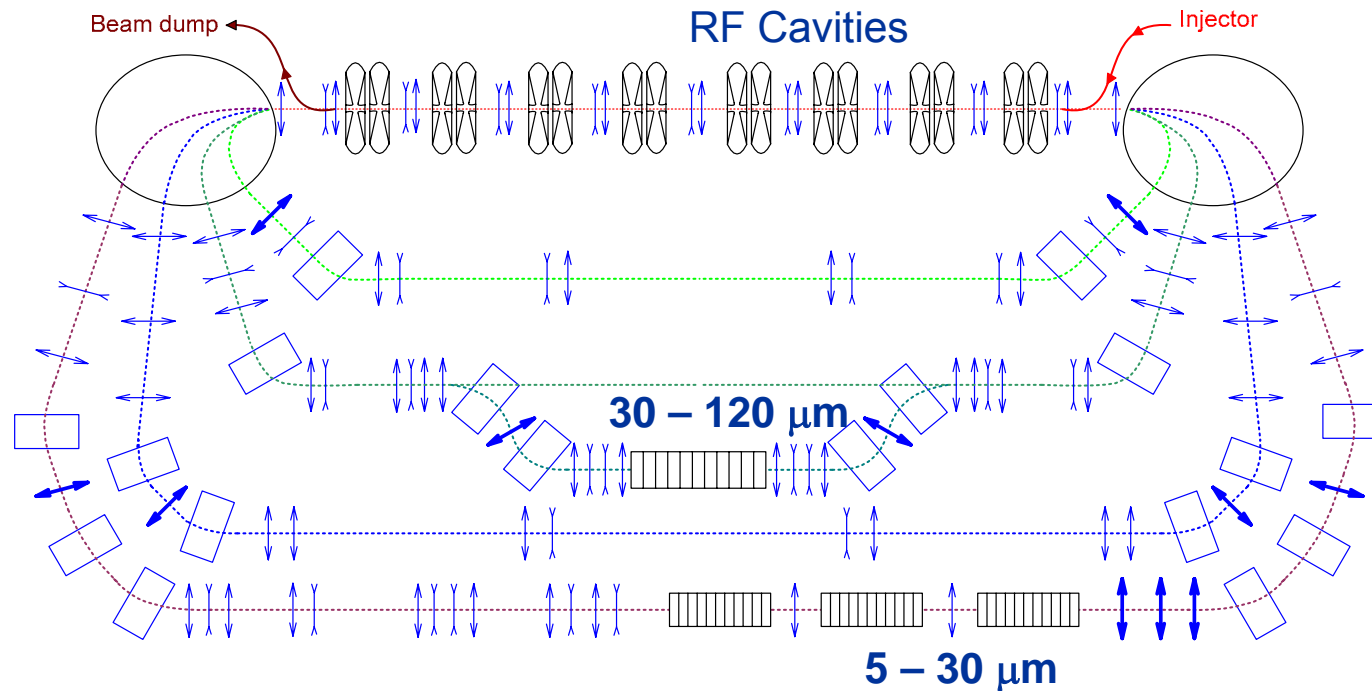

Radiation wavelength	5 – 240 μm
Average power	Up to 10 kW
E-beam energy	up to 40 MeV
Maximum repetition rate	90 MHz
Maximum mean current	150 mA

Taking into account the 120 – 240 μm of the NovoFEL 1st stage placed in the vertical plane

Full scale Novosibirsk FEL

Four tracks in the horizontal plane
with two groups of undulators and IR FEL
(under assembling)

Lasing (2)

Accelerating system
common for all the FELs

One track in the vertical plane
with one undulator THz FEL

Lasing (1)

Lasing (4)

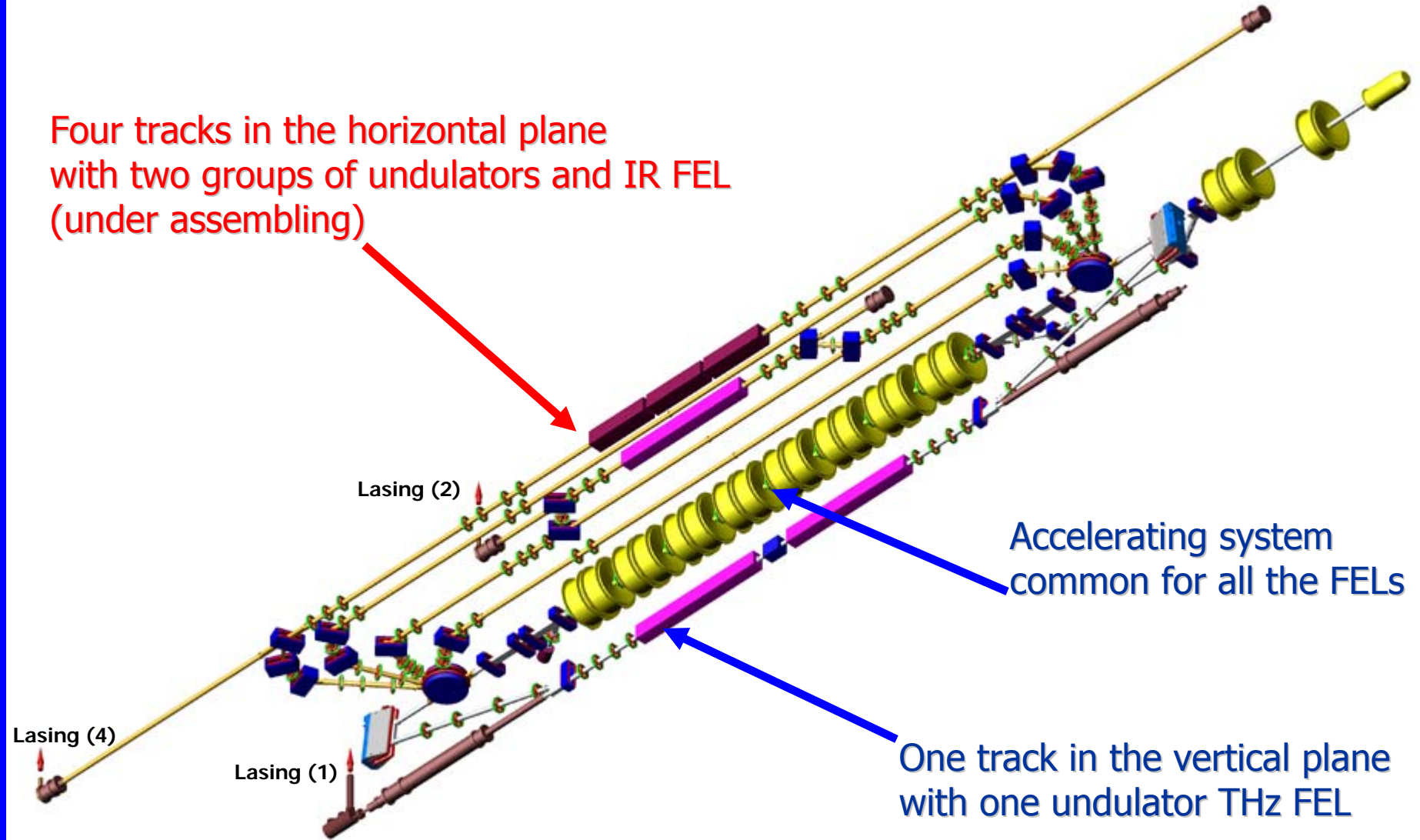

Second stage of NovoFEL

The full-scale 4-track accelerator-recuperator uses the same accelerating structure as the accelerator-recuperator of the 1st stage. However, in contrast to the latter, it is placed in the horizontal plane. Thus, there is no need in dismantling one for installing another.

The operation regime on one of the two machines and one of the three FELs is chosen by simple switching of the bending magnets.

On February 2, 2009, the first lasing ($\lambda=50\ \mu\text{m}$) was achieved on the 2nd stage FEL (the 2-turn AR)

Second turn

First turn

Undulator of the 2nd stage of
NovoFEL

Summary: A bright future

- ERLs provide a powerful and elegant paradigm for high average power free electron lasers.
- The pioneering ERL FELs have established the fundamental principles of ERLs.
- The multitude of ERL-FEL projects and proposals worldwide promises an exciting next decade as:
 - Three currently operating ERL-FELs will reach higher performance
 - At least four more are in serious planning stages and will likely be constructed
 - New advanced concepts are being explored

Daresbury: ERL Prototype

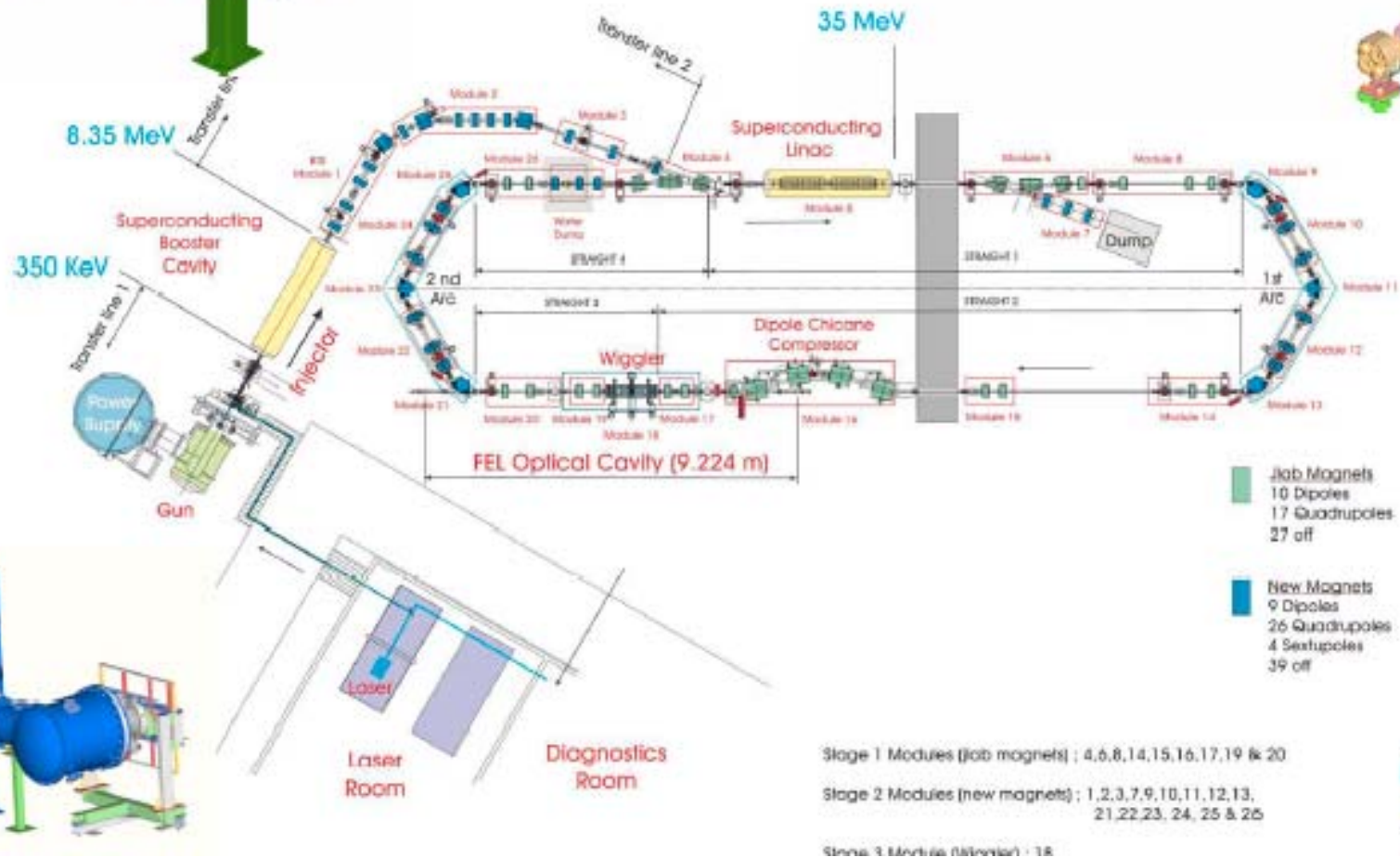
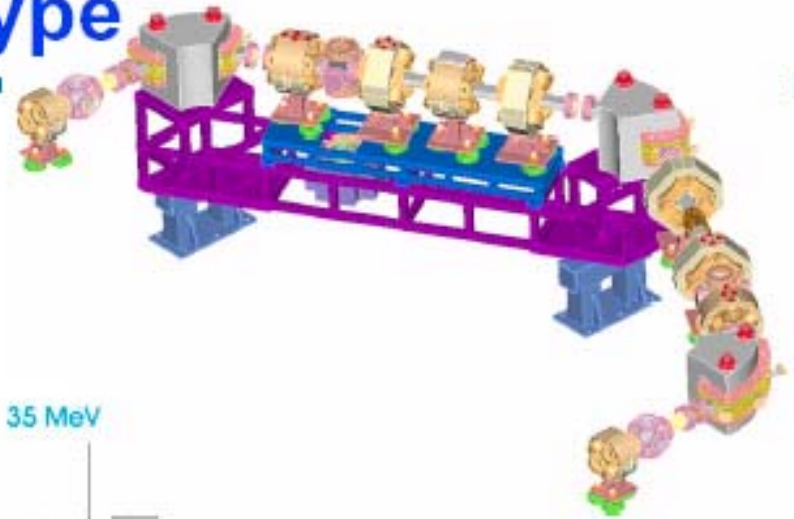

KAERI FEL

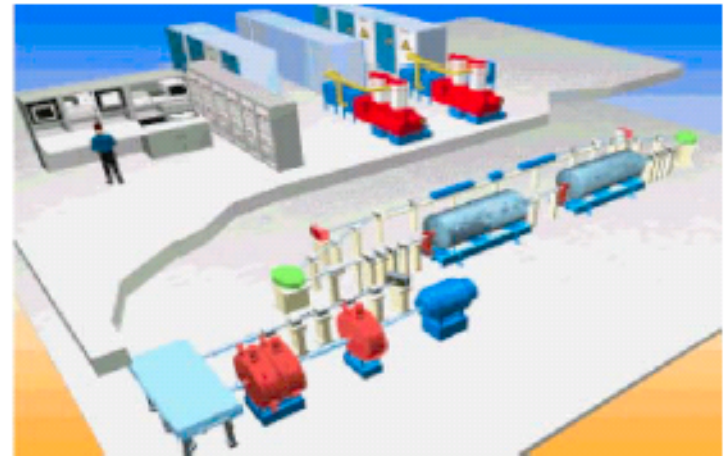

Output Light Parameters	Goal
Wavelength range (microns)	3-20
Bunch Length (FWHM psec)	20-50
Laser power / pulse (mJoules)	50-250
Laser power (kW)	1-5
Rep. Rate (MHz)	22
Macropulse format	CW

Electron Beam Parameters	Goal
Energy (MeV)	20-40
Accelerator frequency (MHz)	352
Charge per bunch (pC)	500
Average current (mA)	10
Peak Current (A)	10-25
Beam Power (kW)	200-400

Electron optical scheme of the machine

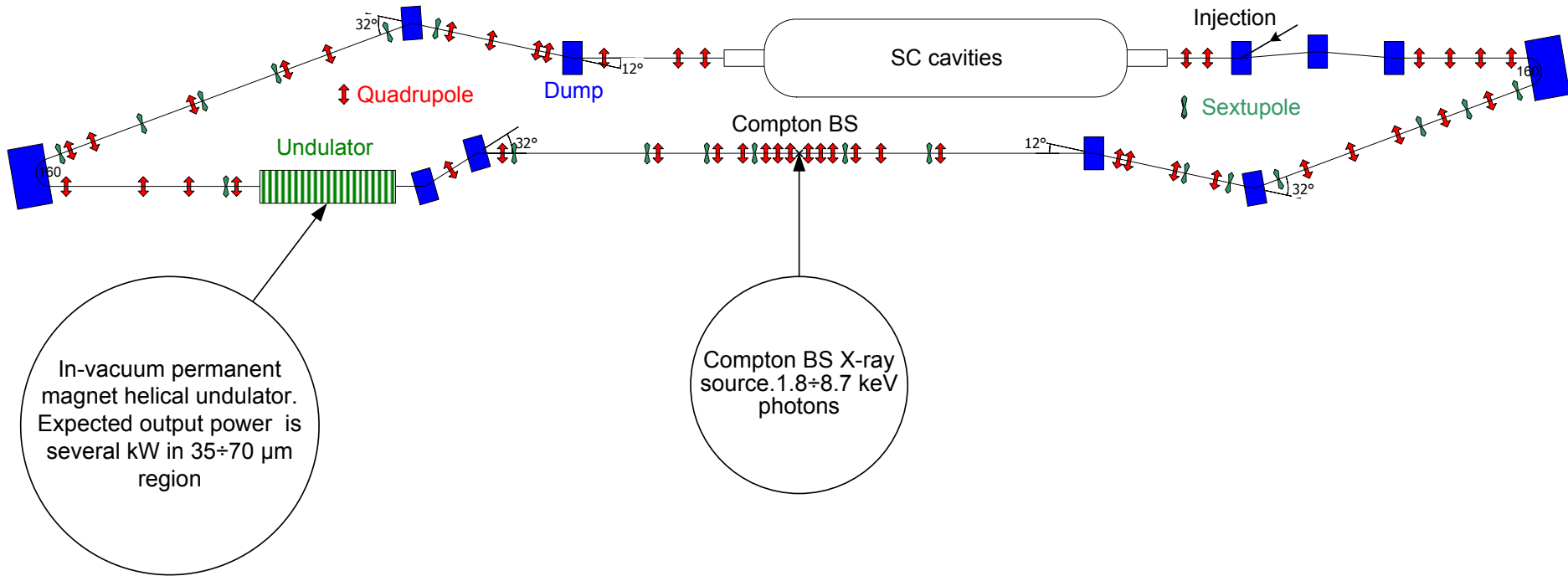

High-power IR FEL on the base of the superconducting linac at KAERI, Korea.

352-MHz 2x50 kW RF-system, injection and extraction beamlines



2 x 50-kW 352-MHz generator modules



2 MeV Injector



Injection beamline



Extraction beamline
10 MeV, $I_{\text{averaged}} = 5 \text{ mA}$



6. Technical solutions for realization of the 4th generation SR sources based on accelerators-recuperators

The development of accelerators-recuperators for various purposes (FEL, SR sources, electron cooling) was discussed in detail at the Conferences ERL-2005, ERL-2007 and ERL-2009. Independently of the posed tasks, many accelerator-recuperator systems can be realized technically.

Therefore, at present, it would be better to discuss only parameters of different systems required for creation of the 4th generation SR sources on the base of a single-pass or multi-pass accelerator-recuperator.

Electron gun

- Main requirements to the electron gun

$$\varepsilon_n < \varepsilon_{x,z} \cdot \gamma \quad \varepsilon_n < 10^{-7} \text{ m}\cdot\text{rad} !!$$

- Different types of electron guns such as DC-thermionic emission, DC-photocathode, normal conducting photocathode RF guns, superconducting photocathode guns have been constructed and tested; some electron guns are under construction or analysis.

For details see lecture by Prof. F. Sannibal “Electron sources”

- the normalized emittance $\varepsilon_n < 10^{-7}$ m·rad has been obtained for bunches of electrons with the charge

$Q = 7.7 \cdot 10^{-12}$ C and duration $\tau_{\text{pulse}} = 14$ ps (ERL-2005).

- Due to using small bunch charge ($Q=8$ pC) and relatively long bunch length (2 ps) we hope to not observe effects of growth of transverse and longitudinal emittance and beam loss due to:

- coherent synchrotron radiation.
- intrabeam scattering (Touschek)
- disturbance from ions.

DC

Cornell University

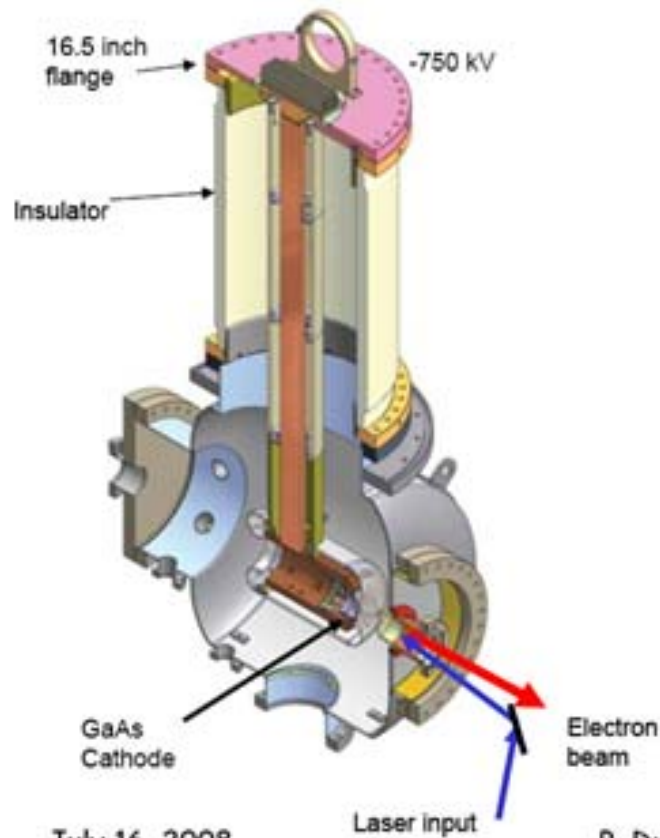

July 16, 2008

B. Dunham,

NRF

Boeing
25% DF



SRF

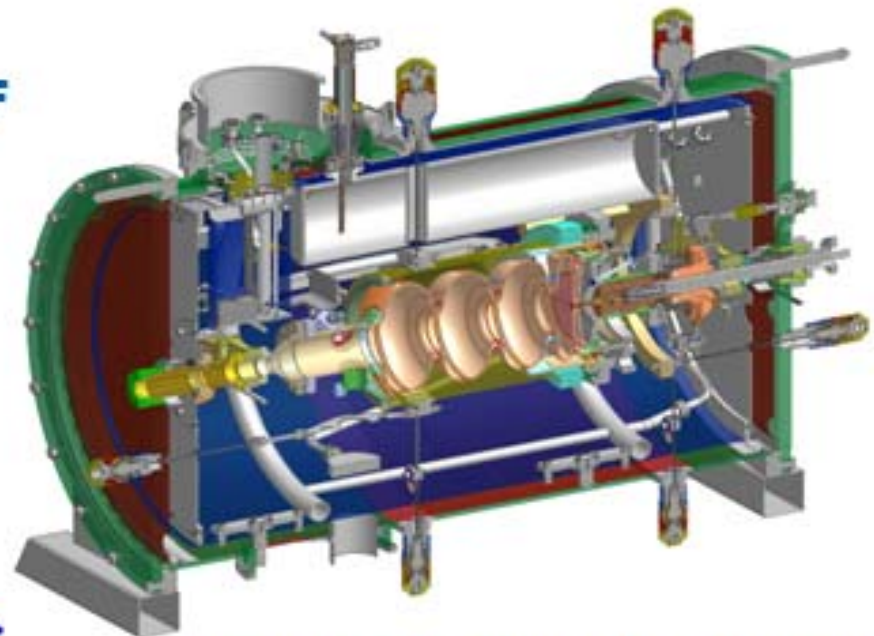

The Rossendorf SRF gun

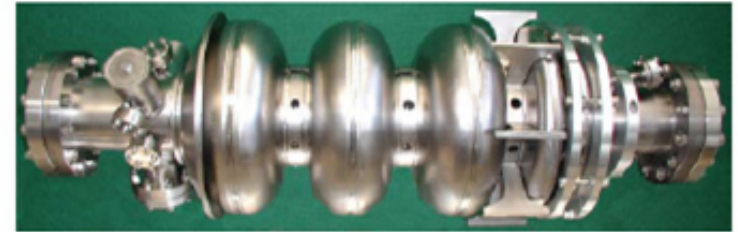
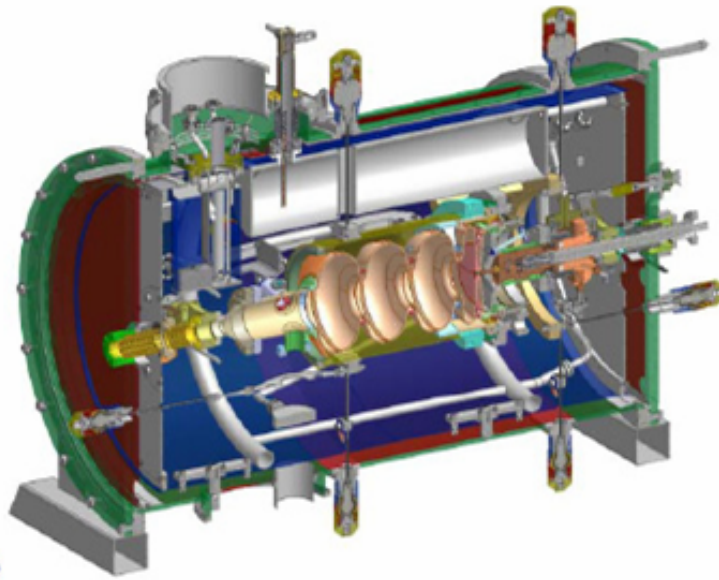

- 1.3 GHz, 9.5 MeV, CW operation
 3 modes of operation:
- 77 pC at 13 MHz
 - 1 nC up to 1 MHz (1 mA)
 - 2.5nC at 1 kHz

	ELBE mode	high charge mode	BESSY-FEL
RF frequency	1.3 GHz		
beam energy	9.5 MeV		
operation	CW		
drive laser	262 nm		
photocathode	Cs ₂ Te		
quantum efficiency	11 %		12.5 %
average current	1 mA		2.5 μA
pulse length	5 ps	20 ps	50 ps
repetition rate	13 MHz	1 MHz	1 kHz
bunch charge	77 pC	1 nC	2.5 nC
transverse emittance	1.5 μm	2.5 μm	3.0 μm

Measurements and Simulations for 20-pC Bunch at 14 GeV

Measured Slice Emittance

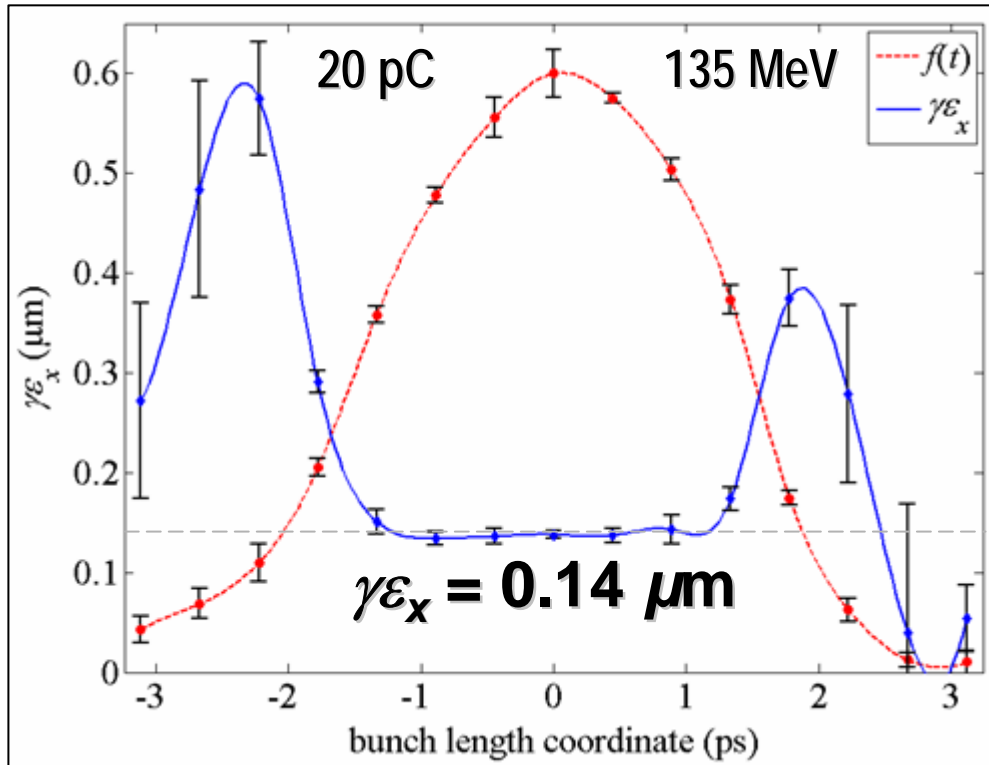

Simulated FEL Pulses

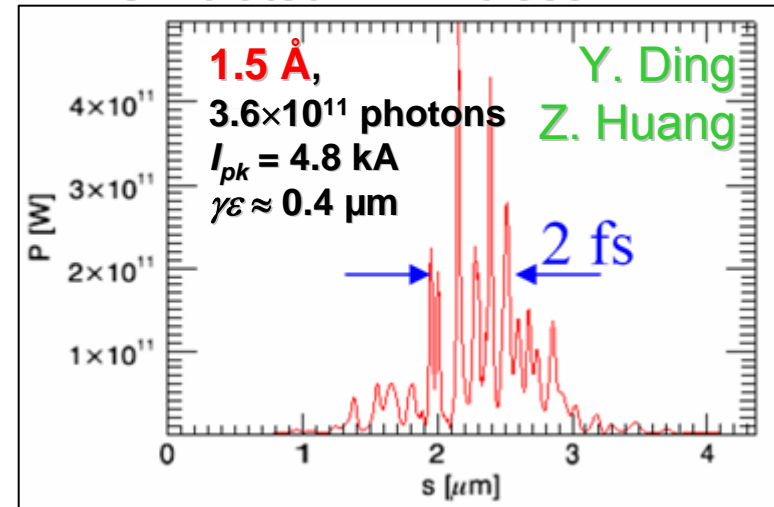

Simulation at 1.5 Å based on measured injector & linac beam & *Elegant* tracking, with CSR, at 20 pC.

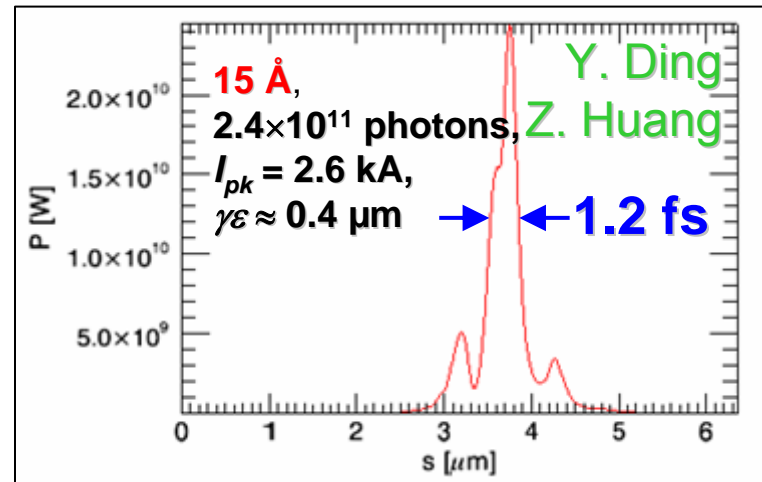
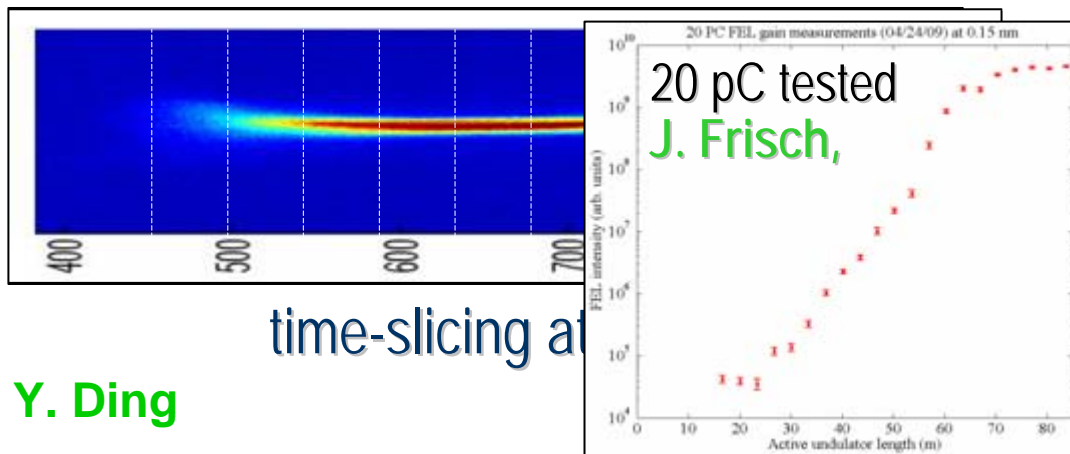

Simulation at 15 Å based on measured injector & linac beam & *Elegant* tracking, with CSR & 20 pC.

Now some projects of accelerators-recuperators assume the use of a single-turn version (ERL) with current up to 100 mA, unlike our first proposal of 1997 to use a multi-turn accelerator-recuperator (MARS) with low current (1-5 mA), long bunch length ($\tau \sim 1-2$ ps) and long undulators (N_u up to 10^4).

Therefore, it is important to compare the ERL and MARS based radiation sources from the viewpoint of their realization.

One-pass high-current ERL

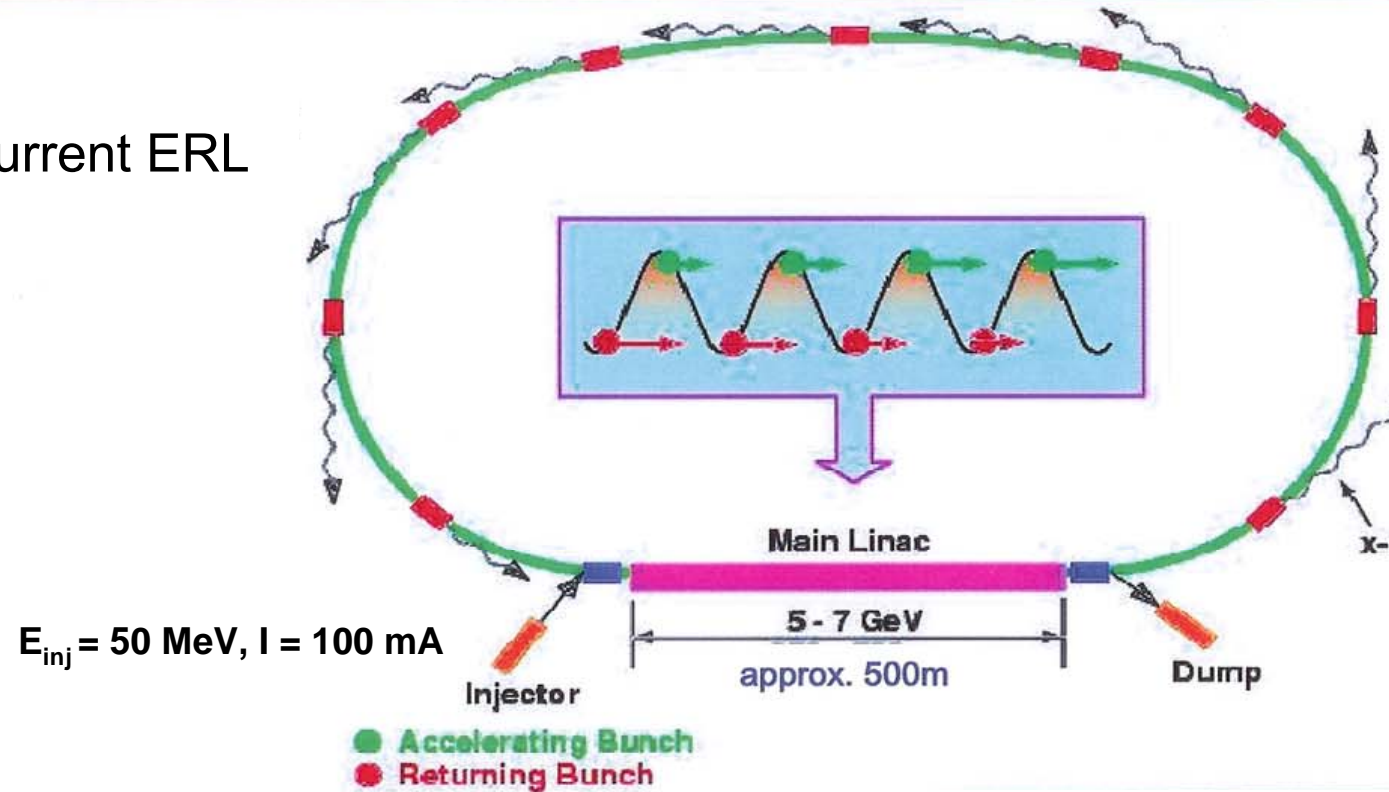

Challenges:

- Low emittance, high current creation?

Maximum electron current

- The version suggested for some single-turn ERL projects - using current up to 100 mA for keeping the photon flux - seems to be far from optimum, since with such an increase in current the brightness does not increase and even decreases sometimes.
- In order to achieve full spatial coherence of the source we suggest that the charge in one bunch be no more than

$$Q = 7.7 \cdot 10^{-12} \text{ C}$$

For $F_{\text{RF}} = 1.3 \text{ GHz}$ that corresponds to a current value of 10 mA for a single-turn accelerator, 5 mA for two-turn accelerator and 2.5 mA for a four-turn accelerator.

- To compensate the decrease in the current value as compared with the 3rd generation SR sources, we shall use radiation only from long undulators with $N_{u1} = 100$, $N_{u2} = 1000$, $N_{u3} = 10\ 000$, not from bending magnets. In this case, we solve the problem of full spatial coherence and at the same time keep the photon flux at the level of the 3rd generation sources.

Comparison of the parameters of the SR sources

MARS ($I_e=2.5$ mA) and Spring-8 ($I_e=100$ mA)

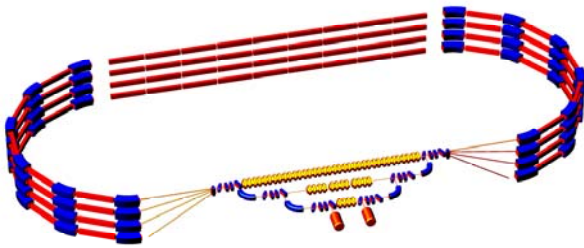

		Number of beamlines	$B,$ $\text{ph}\cdot\text{sec}^{-1}\cdot\text{mm}^{-2}\cdot\text{mrad}^{-2}$ ($\delta\lambda/\lambda=10^{-3}$)	$F,$ ph/sec ($\delta\lambda/\lambda=10^{-3}$)
MARS	Undulator $N_u\sim 10^2$	32	10^{22}	$4.6\cdot 10^{13}$
	Undulator $N_u\sim 10^3$	12	10^{23}	$4.6\cdot 10^{14}$
	Undulator $N_u\sim 10^4$	4	10^{24}	$4.6\cdot 10^{15}$
SPring-8	Bending magnet	23	10^{16}	10^{13}
	Undulator $N_u=130$	34	$3\cdot 10^{20}$	$2\cdot 10^{15}$
	Undulator $N_u=780$	4	10^{21}	$1.2\cdot 10^{16}$

One-pass high-current ERL

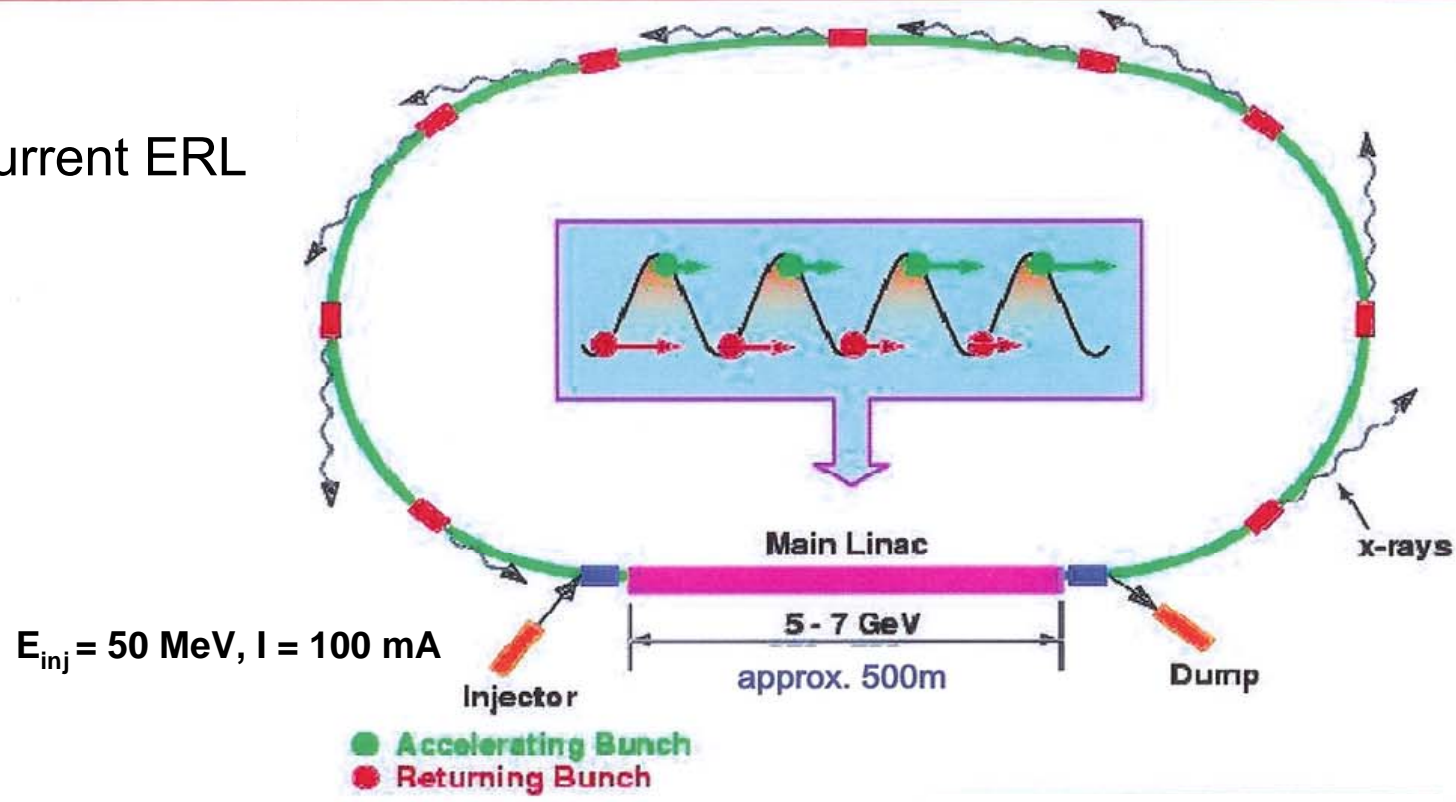

Challenges:

- Low emittance, high current creation?
- Focusing electrons of different energies travelling simultaneously in the main linac ($E_{max}/E_{inj} = 100$) ?
- Radiation hazard and induced radioactivity at the dump ?

Cascade injection – effective solution to important problems

The first linac has an energy of 5-8 MeV and does not use energy recovery. For booster linacs (30 MeV and 330 MeV energy gain) energy recovery is used.

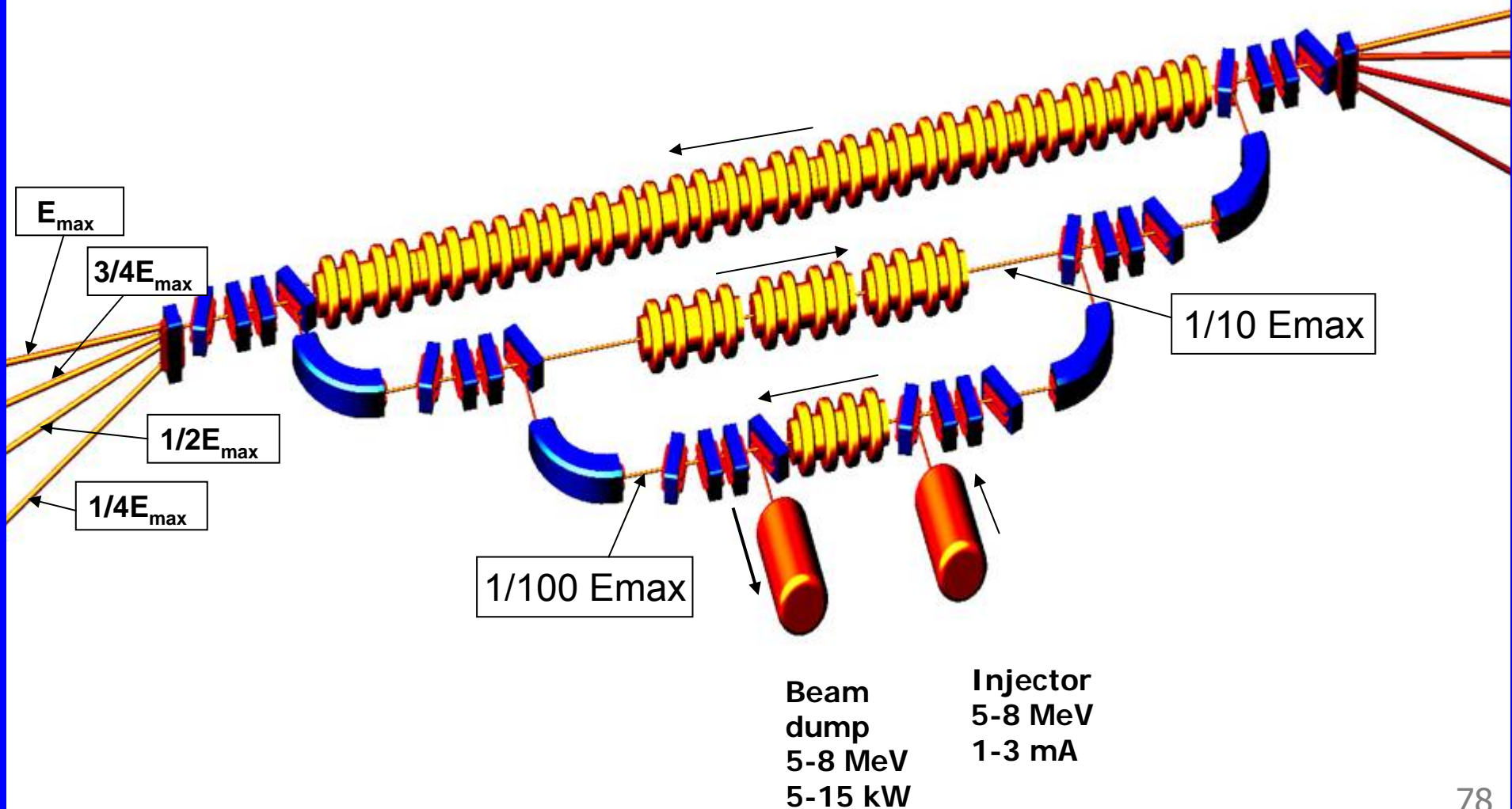

Cascade scheme of injection provides effective and economical solution to the following problems:

- ❑ Decrease in radiation hazard and limitation of induced radioactivity due to low energy of electrons at dump (5-8 MeV).
- ❑ Reduction in the cost of construction and RF power system for the injector.
- ❑ Simplification of the problem of focusing particles of different energies traveling simultaneously in the accelerating structure. Indeed, the cascade scheme enables injection of electrons into all accelerating structures with energies no less than $E_{\max}/10$ (E_{\max} is the maximum energy of electrons traveling in the accelerating structure).

Layout of 3 GeV ERL with cascade injection

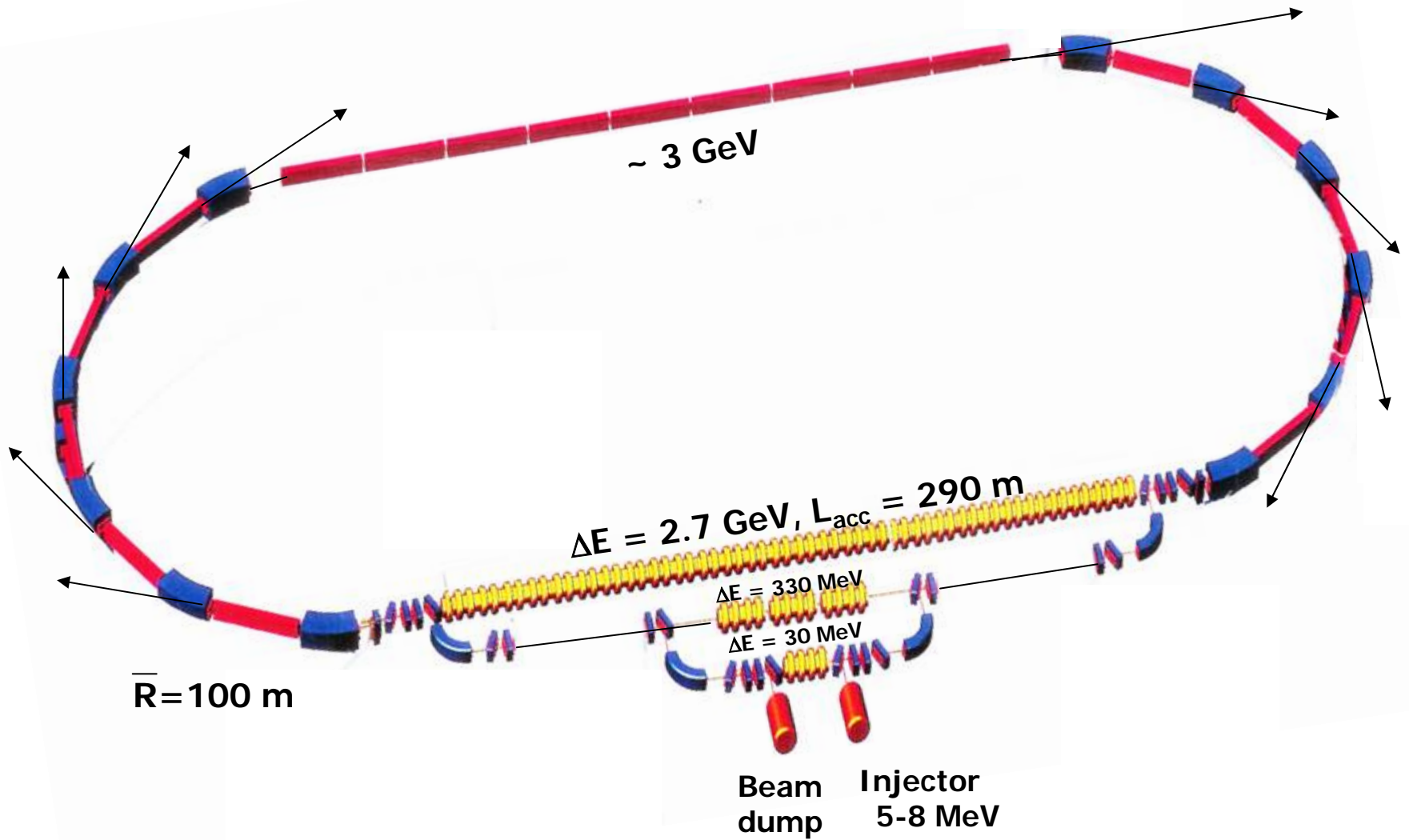

Layout of 3 GeV two-pass accelerator-recuperator with cascade injection

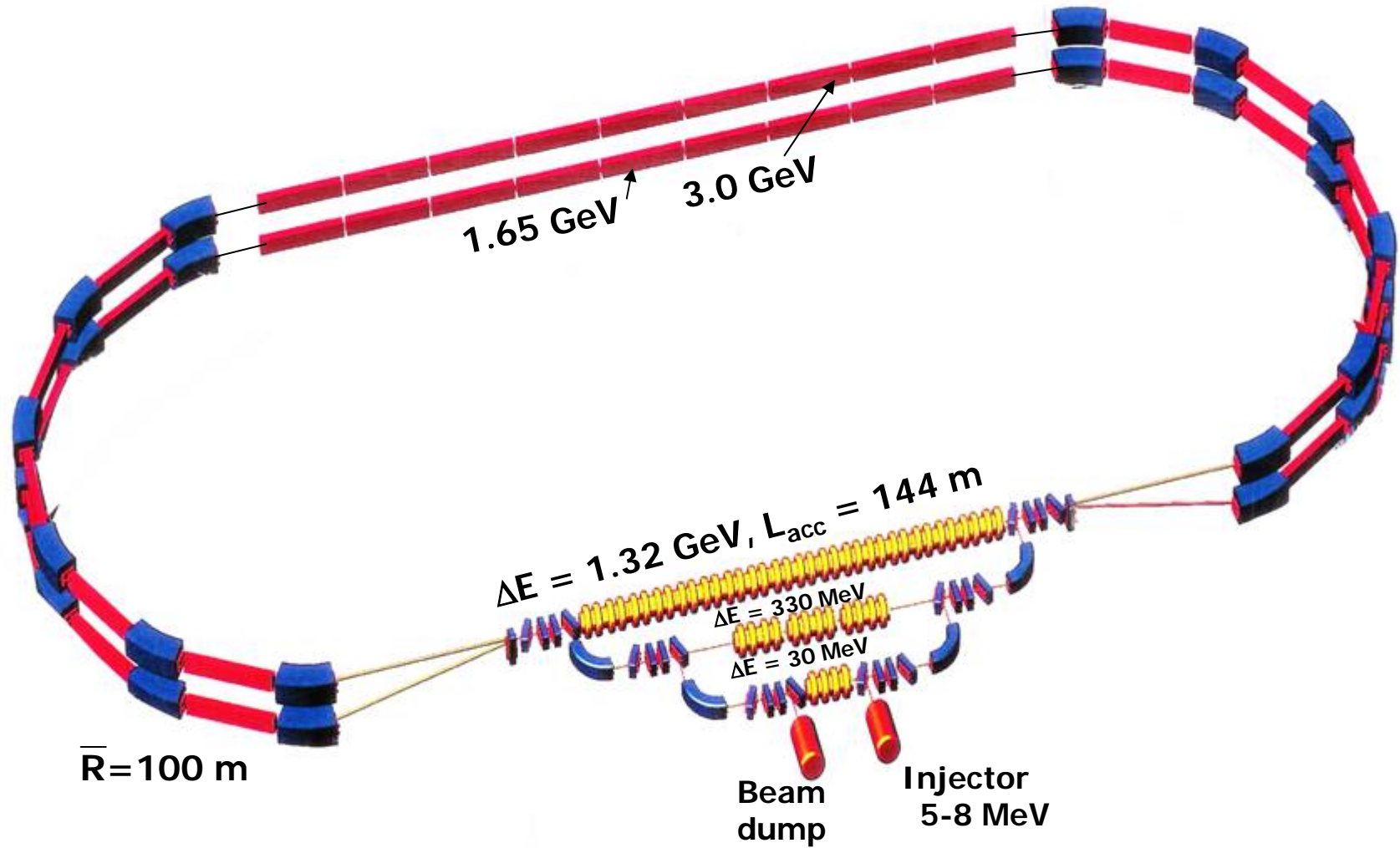

Layout of 4.4 GeV three-pass accelerator-recuperator

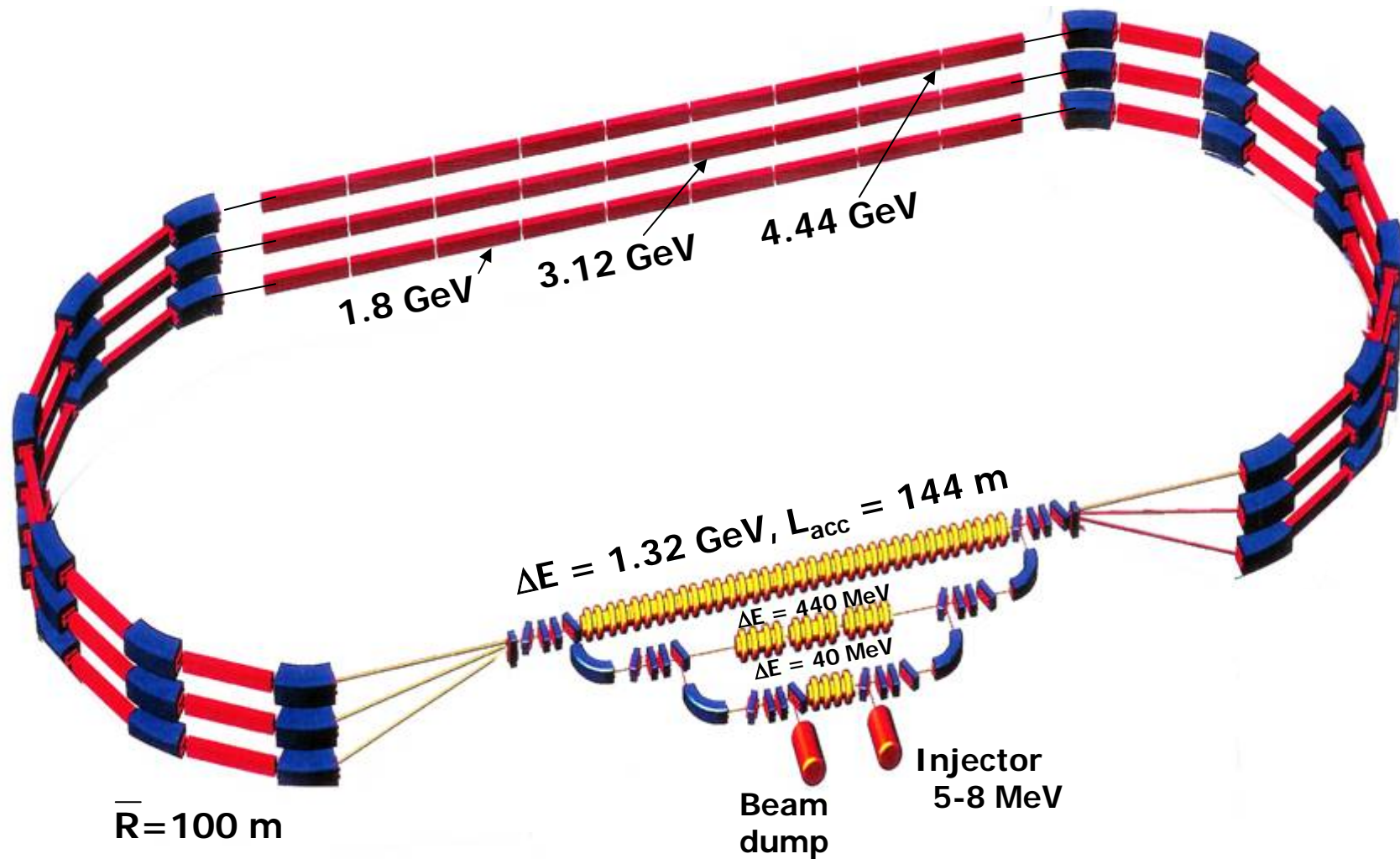

Layout of 5.7 GeV four-pass accelerator-recuperator

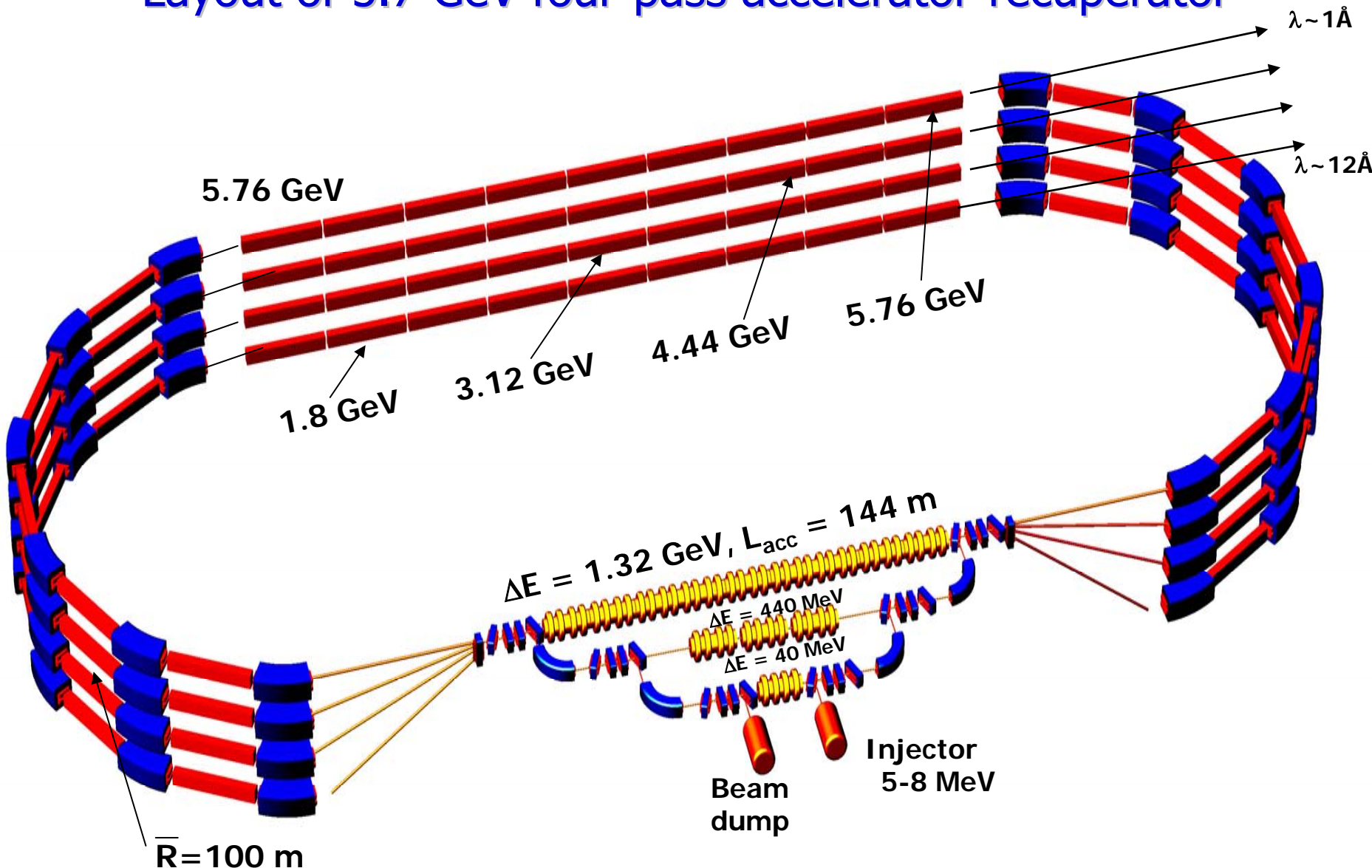

Superconducting RF ("ERL 2005" Conference)

Superconducting RF technology was developed by Cornell University, KEK, CERN, Jefferson Lab, and DESY.

Parameters of the TESLA cryomodule:

- Cryostat length $L = 12 \text{ m}$
- Gradient 15 MV/m
- Energy gain $\Delta E = 110 \text{ MeV}$
- AC power 0.6-0.9 MW per cryomodule

The existing SC modules or modules that are under construction include

- the CEBAF-type module developed by TJNAF,
- the TTF module developed by the TESLA collaboration,
- the injector cryomodule under construction for the Cornell ERL, and
- the KEK-type module developed in Japan.

Low microphonic cavity and cryomodule design is a very important task (especially for low current operation $I < 10$ mA):

- minimization of the cavity vibration and coupling of external sources with cavities
- low sensitivity to He pressure changes (0.1 – 1 mbar)
- high mechanical vibration frequencies
- active frequency control and fast frequency tuning (piezo tuner) essential for realistic microphonics (20-30 Hz peak detuning) and $Q_L > 3 \times 10^7$.



Measured microphonics levels



CHESS & LEPP

Machine	σ [Hz]	6σ [Hz]	Comments
CEBAF	2.5 (average)	15 (average)	significant fluctuation between cavities
ELBE	1 (average)	6 (average)	
SNS	1 to 6	6 to 36	significant fluctuation between cavities
TJNAF FEL	0.6 to 1.3	3.6 to 7.8	center cavities more quiet
TTF	2 to 7 (pulsed)	12 to 42 (pulsed)	significant fluctuation between cavities

$$Q_{L,\text{optimal}} = \frac{1}{2} \frac{f_0}{\Delta f} \quad P_{g,\text{minimal}} = \frac{V_{acc}^2}{2R/Q} \frac{\Delta f}{f_0}$$

- Assume optimistic 10 Hz as typical detuning (< 20 Hz peak).
- $\Rightarrow QL=6.5 \cdot 10^7$
- This minimizes the typical (average) power need, not the maximum power that has to be available.



Microphonics and the optimal Q



CHESS & LEPP

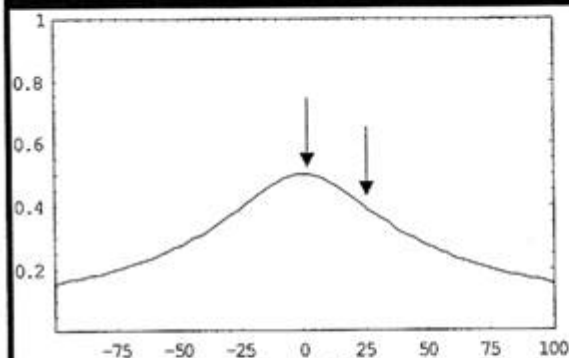

Higher Q \rightarrow less power needed

Detuning \rightarrow more power needed especially for larger Q

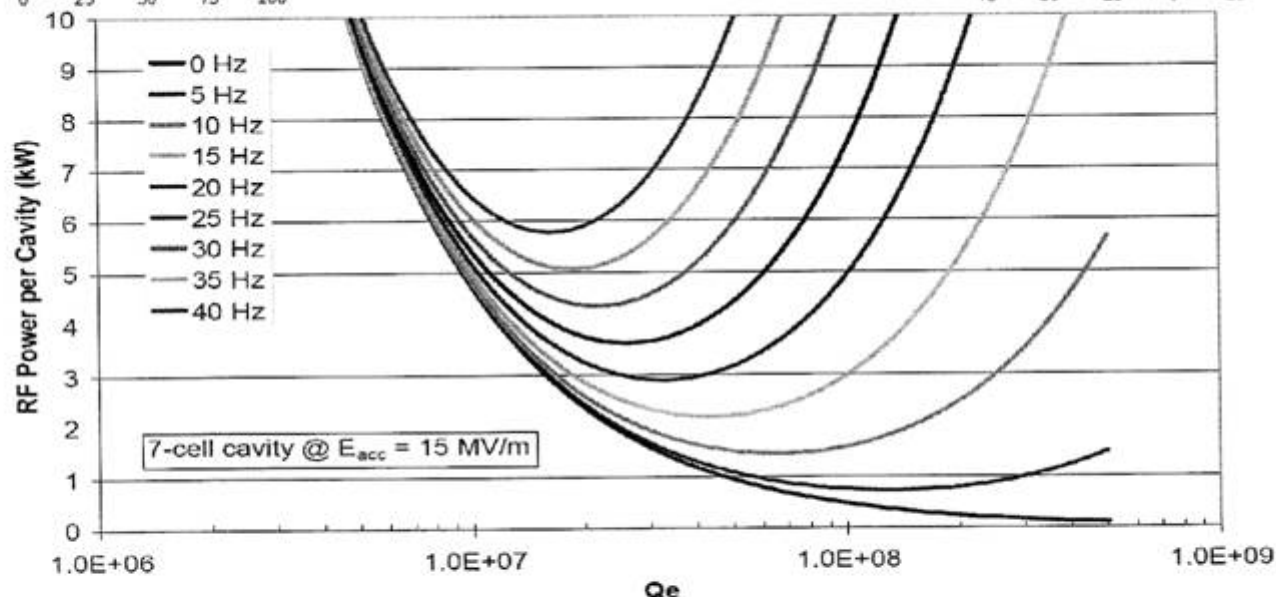
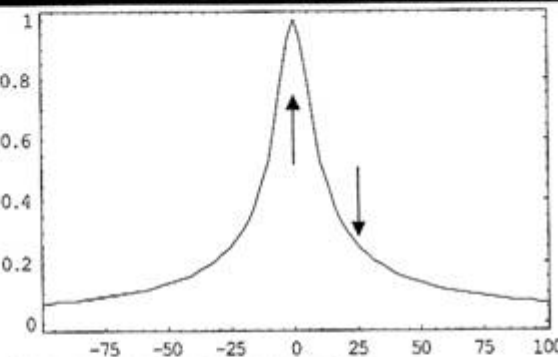

- Cavity and cryostat design for low microphonics
- Active frequency control (fast frequency tuner)
- Lacking detailed knowledge, we work with 20Hz peak detuning.



ERL cavity performance



CHESS & LEPP

Operation spec: 16 MV/m

But to have sufficient safety margin we design the Cryomodule for:

- max. supported gradient by cryo module: 20 MV/m at $Q = 1 \cdot 10^{10}$
- RF power installed for 20 MV/m, 20 Hz peak detuning = 5kW / cavity
- Min. (guaranteed) cavity performance in linac: 16 MV/m at $Q = 2 \cdot 10^{10}$
- Average cavity performance in linac: 18 MV/m at $Q = 2 \cdot 10^{10}$ with ± 2 MV/m spread to allow loosing 4 cryomodules.
- 5GeV requires 390 seven-cell cavities !
- \Rightarrow Can use BCP cavities (Q-lope starts at ≈ 20 MV/m)

- This provides more than 10% safety margin

Accelerator Module Prototype PXFEL1

China
France
Germany
Italy
Spain

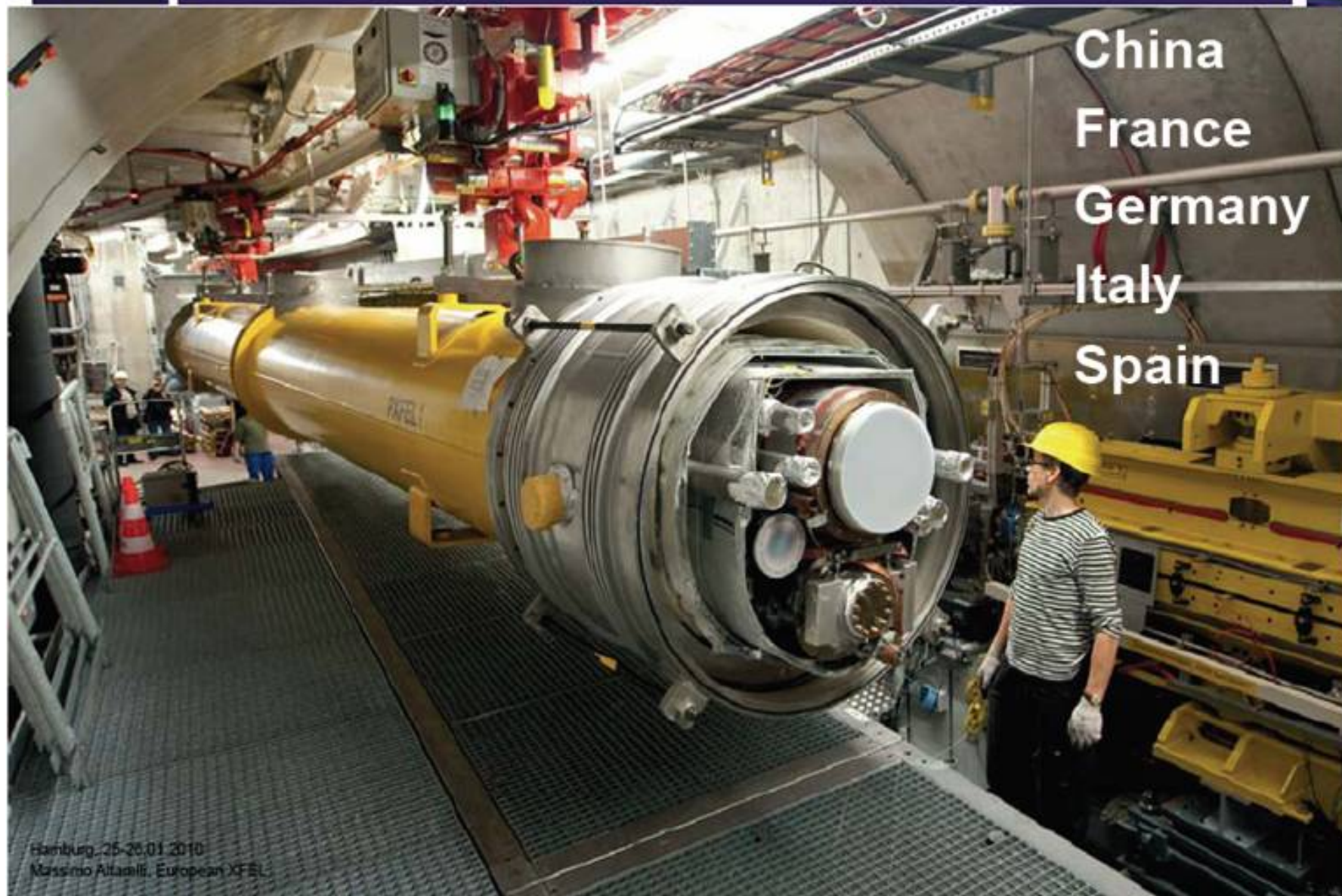



The undulator

- The undulator gap will be limited mainly by radiation losses in the walls of the vacuum chamber; $g = 0.5$ cm seems to be reasonable.
- Choosing the undulator parameter $K \sim 1$ for $g = 0.5$ cm, one can obtain from the Halbach equation $\lambda_u = 1.5$ cm .
- The maximum length of the undulator is determined by the increase in energy spread in the undulator due to quantum fluctuations of undulator radiation.

$$\text{For } E = 6 \text{ GeV} : \left(\frac{\sigma_E}{E} \right)_{\max} = 3 \cdot 10^{-5}$$

$$\lambda_u = 1.5 \text{ cm}; K = 1 \quad L_u < 180 \text{ m}$$

**See details in Lecture by Prof. B. Deviacco “Undulators”
Lecture by Prof. N. Mezentsev “SC Undulators”**

- The undulator shall be segmented into sections of $L \sim 5$ m with a 1 m straight section in between. Each straight section contains a 3-pole phase adjuster, focusing quadrupoles, steering magnets, and beam position monitor.
- The quadrupoles between the undulator sections are necessary to provide equal and almost constant (inside the undulators) beta functions $\beta_x \sim \beta_z$
- For a very long undulator, the superconduction technology or a combination of the electromagnet and permanent magnet technology (equipotential-bus electromagnetic undulator) can be more appropriate for tuning the photon energy.
- Photon beam monitors and a monochromator for spectral measurements shall be installed on the beamline for feedback to the steering coils and phase adjusters.

Undulator for X-ray FEL (ANL, USA)

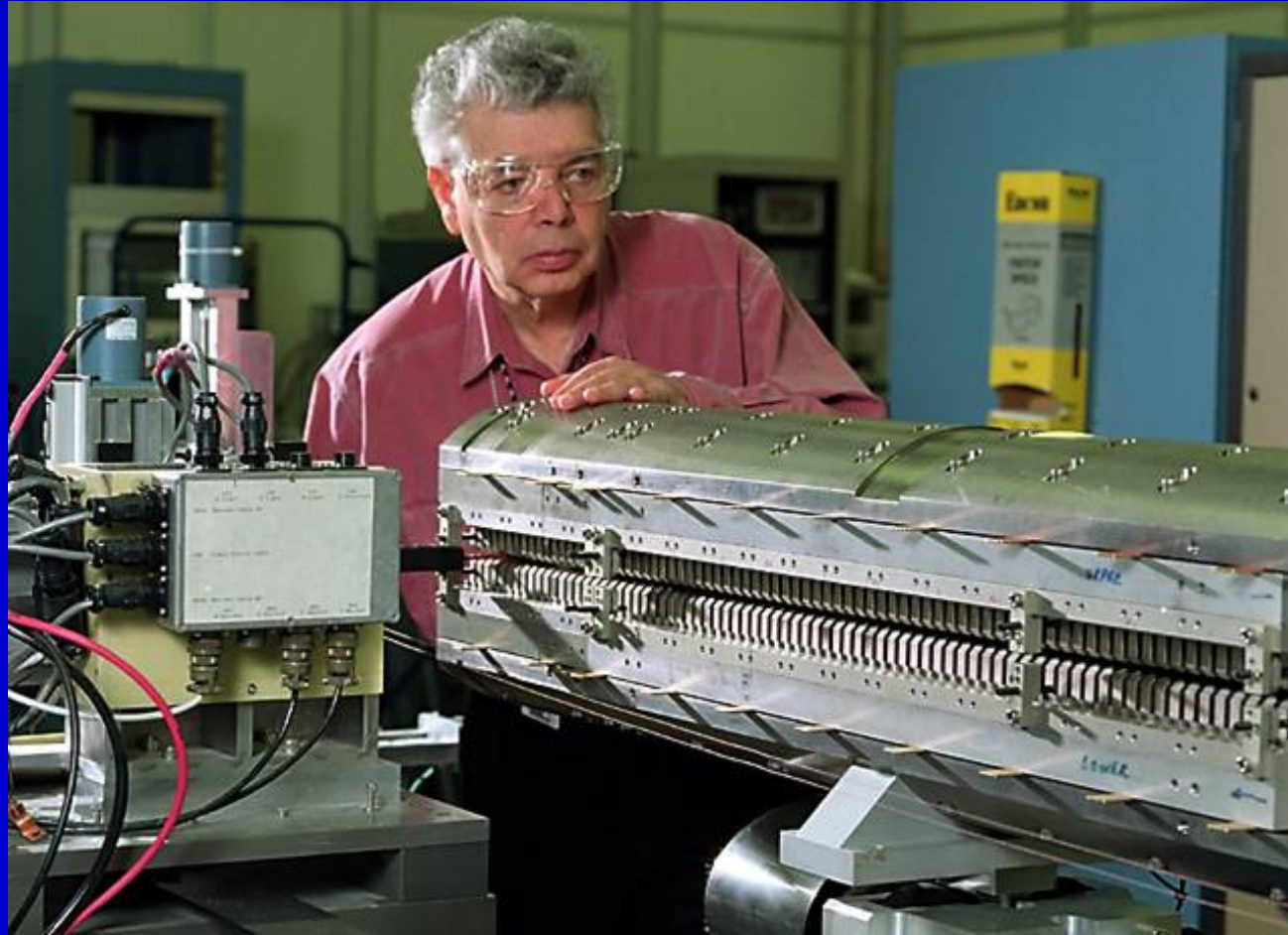

• Gap	6.8	mm
• Period Length	30.0 ± 0.05	mm
• Effective On-Axis Field	1.249	T
• Segment Length	3.40	m
• Number of Segments	33	
• Undulator Magnetic Length	112.2	m

Overview over Undulator Systems

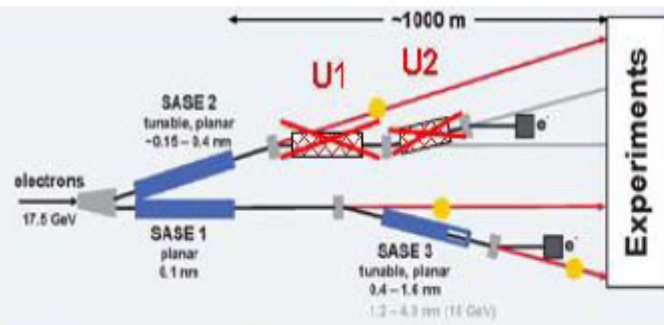
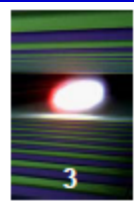

- 3 Undulator systems
- 3 Photon diagnostics
- 3 Photon beamline
- 6 Instruments

Startup Scenario

- SASE1: Full
- SASE2: Shortened by 5 Seg
- SASE3: Linear

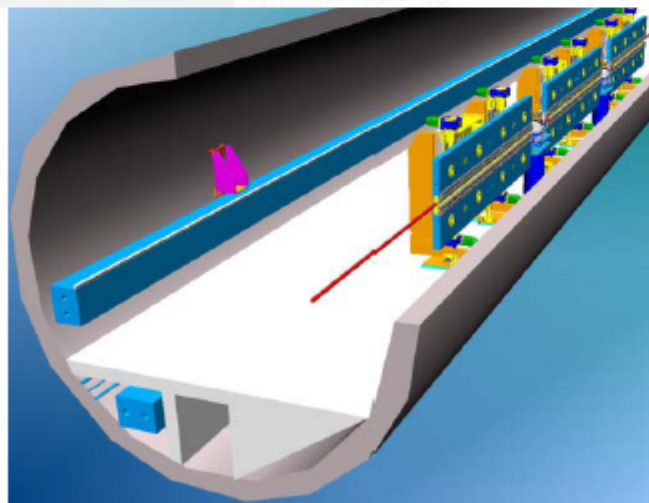

Undulator System in Tunnel

Cell Structure

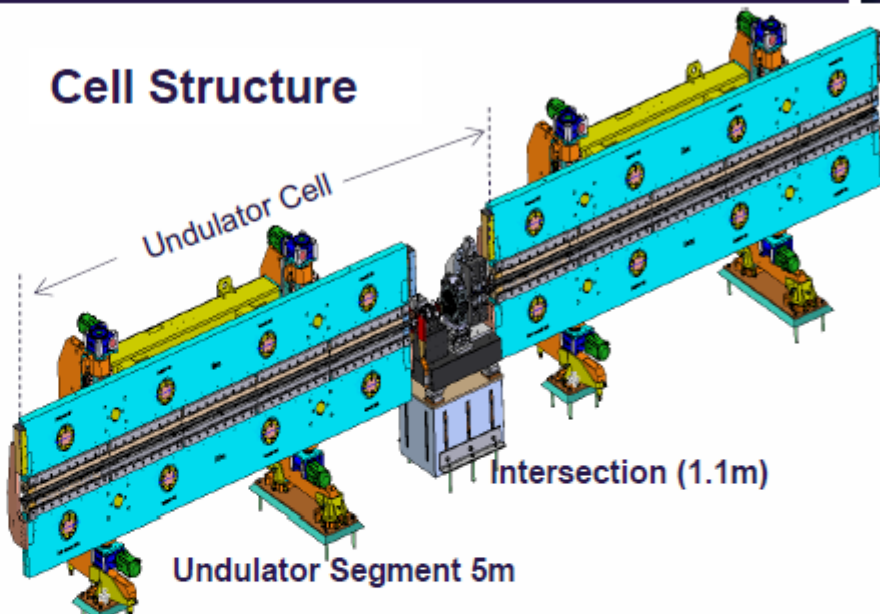

Startup Szenario with reduced scope Summer 2007

	λ_R [Å]	λ_0 [mm]	Gap [mm]	B_0 [T]	K	β_0 [m]	L_{Sat}^+ [m]	N_{Tot}^{**}	L_{Tot}^{+++} [m]
SASE 1 *	1	35.6	10	1.0	3.3	32	133	33	201.3
SASE 2 *	1-4	48	19-10	0.63-1.37	2.8-6.1	46-15	174-72	37	225.7
SASE3P *	4-16	65	23-10	0.66-1.76	4.0-10.7	15	≈100	21	128.1
Total								91	555.1

* Planar Hybrid Undulator
 ** 1st Harmonic of Spontaneous Emitters
 + Net saturation length with no contingency for field errors
 ++ Number of 5m undulator segments including 20% contingency
 +++ Total system length includes 1.1m long intersection after each undulator segment

Magnetic lattice

Minimization of growing transverse and longitudinal emittance in injector during compression from 10 ps up to 2 ps (a bunch length of 2 ps is needed to limit the increase in the energy spread of electron during electron bunch acceleration from zero energy to 5-10 MeV at $f_{RF}=1.3$ GHz).

The Injector-to-linac system and the linac-to-linac system shall be achromatic and isochronous for minimization of the pass-to-pass tolerance for the RF phase or path length $<100 \mu\text{m}$. Sextupoles are used to get T_{566} in the bending arc to compensate any curvature induced term.

See details in: Lecture by Prof. A. Wolski “Storage Ring Design”

Effects of Nonlinearities

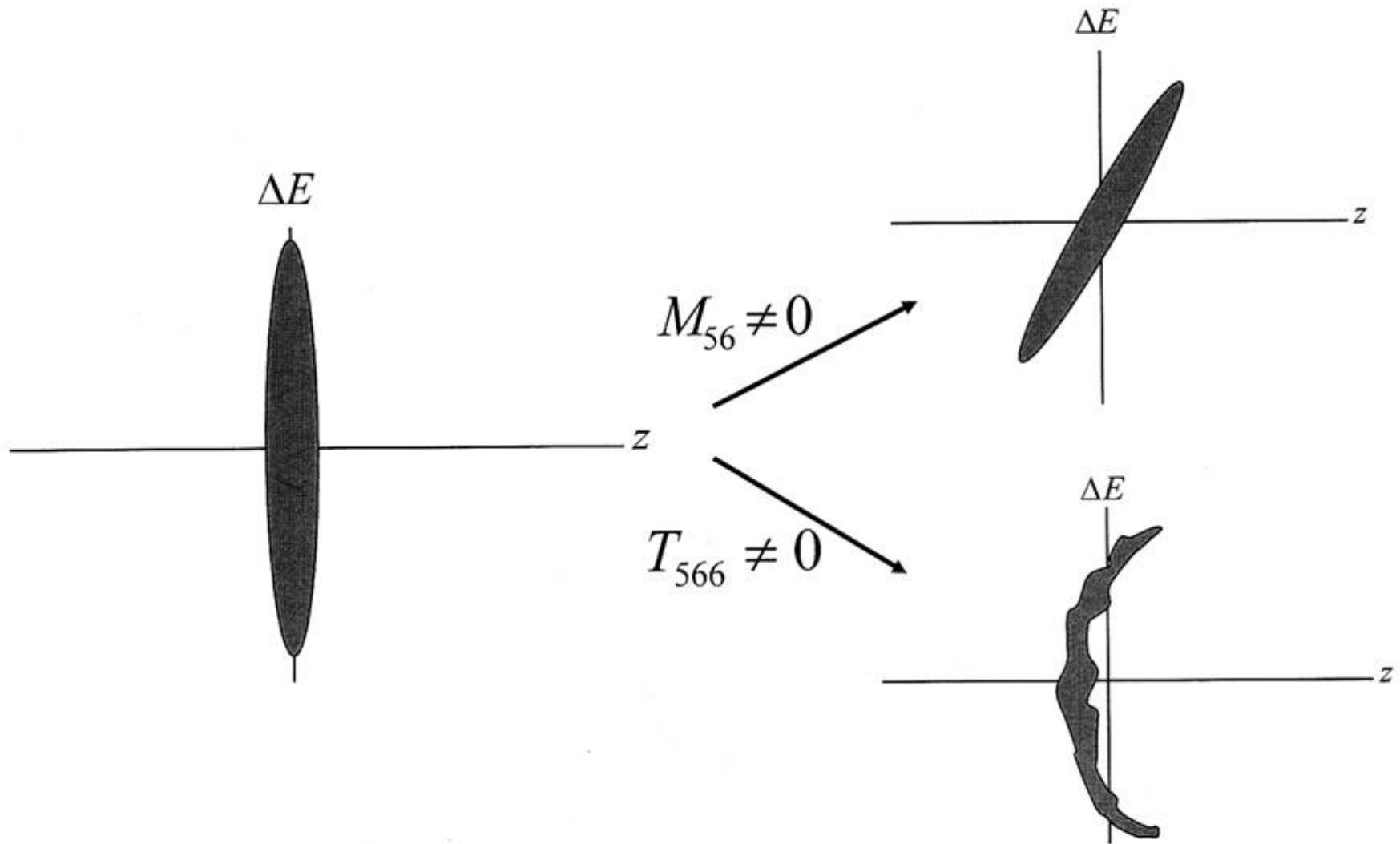

- Quantum fluctuation-induced growth in the electron beam energy spread in the 180° arcs:

$$\left(\frac{\delta E}{E}\right)_{arc}^2 \sim N_{ph.arc} \cdot \frac{\varepsilon_c^2}{E^2}; \quad N_{ph.arc} \sim \frac{1}{137} \frac{E}{m_0 c^2}; \quad \varepsilon_c \sim \frac{E^3}{R}$$

$$\left(\frac{\delta E}{E}\right)_{arc}^2 \sim \frac{E^5}{R^2} \left(\frac{\sigma_E^2}{E^2}\right)_{arc} = 2.6 \cdot 10^{-10} \frac{E^5 [GeV]}{\rho [M]} \frac{\Theta}{2\pi}$$

- This energy spread shall be less than the acceptable energy spread $\left(\frac{\sigma_E}{E}\right)_{\max}$, therefore the bending radius ρ in the magnets shall be large:

$$\rho [m] > \left(\frac{2.6 \cdot 10^{-10} E^5 [GeV]}{\left(\frac{\sigma_E}{E}\right)_{\max}^2} \frac{\Theta}{2\pi} \right)^{1/2}$$

- For $E = 6 \text{ GeV}$: $\left(\frac{\sigma_E}{E}\right) \sim 3 \cdot 10^{-5}$ $\rho [m] > 33m$

- The magnetic system of the arcs consists of small-emittance achromatic cells, typical for the structure of low-emittance light sources (DBA, TBA...). Examples of such structures are shown in the next slide.
- The arrangement of quadrupole magnets in the accelerating sections provides focusing of beams of all energies, from the injection energy to the maximum energy.
- The behavior of the lattice functions has bilateral symmetry to get similar focusing of both accelerated and decelerated beams.

SMALL EMITTANCE LATTICES: ACHROMAT STRUCTURES

$$\varepsilon_x = \frac{c_q \gamma^2}{J_x} \cdot K \cdot u_B^3$$

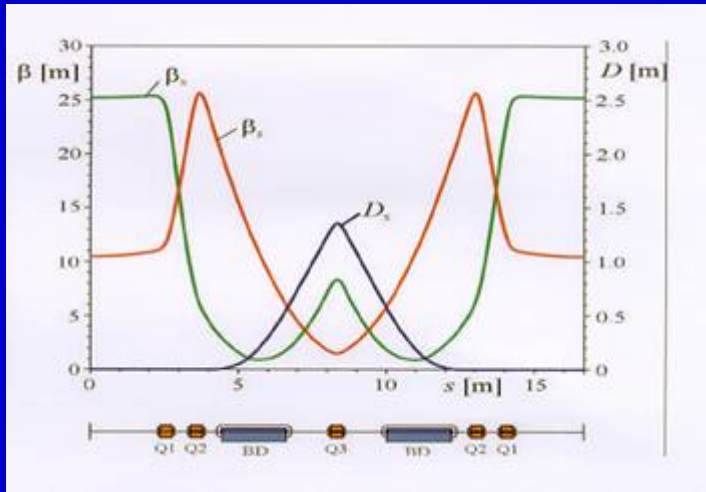

DBA /
Double Bend Achromat

$$K = \frac{1}{4\sqrt{15}} \approx 6,5 \cdot 10^{-2}$$

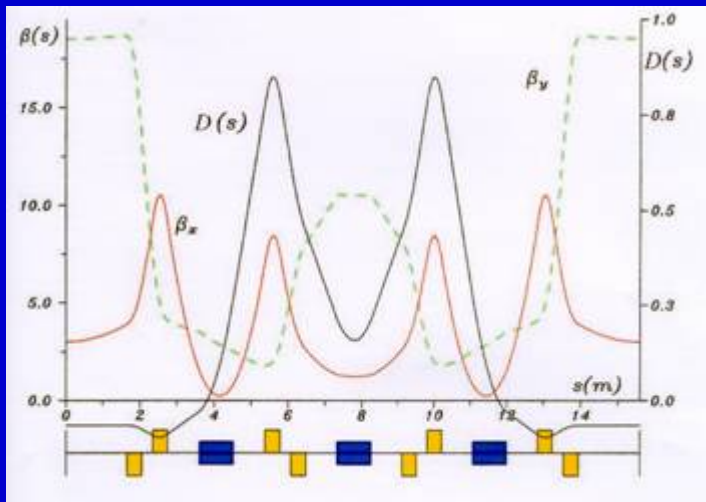

TBA /
Triple Bend Achromat

$$K = \frac{7}{36\sqrt{15}} \approx 5 \cdot 10^{-2}$$

- The arrangement of the matching quadrupoles both adjusts the lattice functions between the RF sections and arc and provides optimal lattice functions in a rather strong separating magnet (which separates beams of different energies). The emittance growth in this magnet is very sensitive to the behavior of the lattice functions.

Since the accelerators-recuperators are single-flight systems, the gap for bending magnets can be taken to be $g=1\text{cm}$; the incircle diameter for the quadrupoles is $\Phi_q=1.5\text{ cm}$ and for sextupoles, $\Phi_s=2\text{ cm}$, which reduces substantially the overall dimensions, weight, power supply and the cost of the magnetic system.

Since for a single-flight system it is enough to have a vacuum of $P \sim 10^{-7}\div 10^{-8}\text{ tor}$, the vacuum system seems to be rather simple.

7. Planned SR sources based on high energy accelerators-recuperators

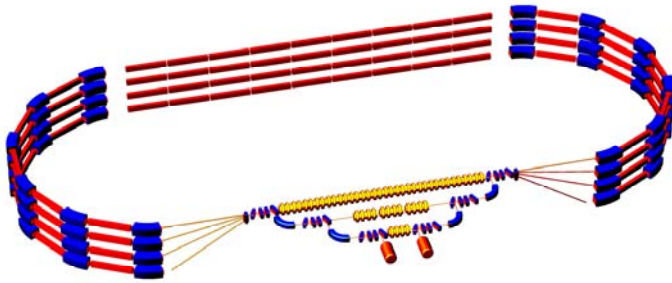

- In MARS, the electrons obtained in the injector with an energy of $\sim 5\text{-}8$ MeV are then accelerated in an additional two-cascade injector, after which they pass through the main accelerating high-frequency structure four times, thus increasing their energy up to 6 GeV.

After acceleration, the electrons again travel in the same direction through the same high-frequency structures but in a deceleration phase, decrease their energy to 5-8 MeV, and then land in the dump. In the MARS, electrons undergoing acceleration and deceleration travel simultaneously along four tracks.

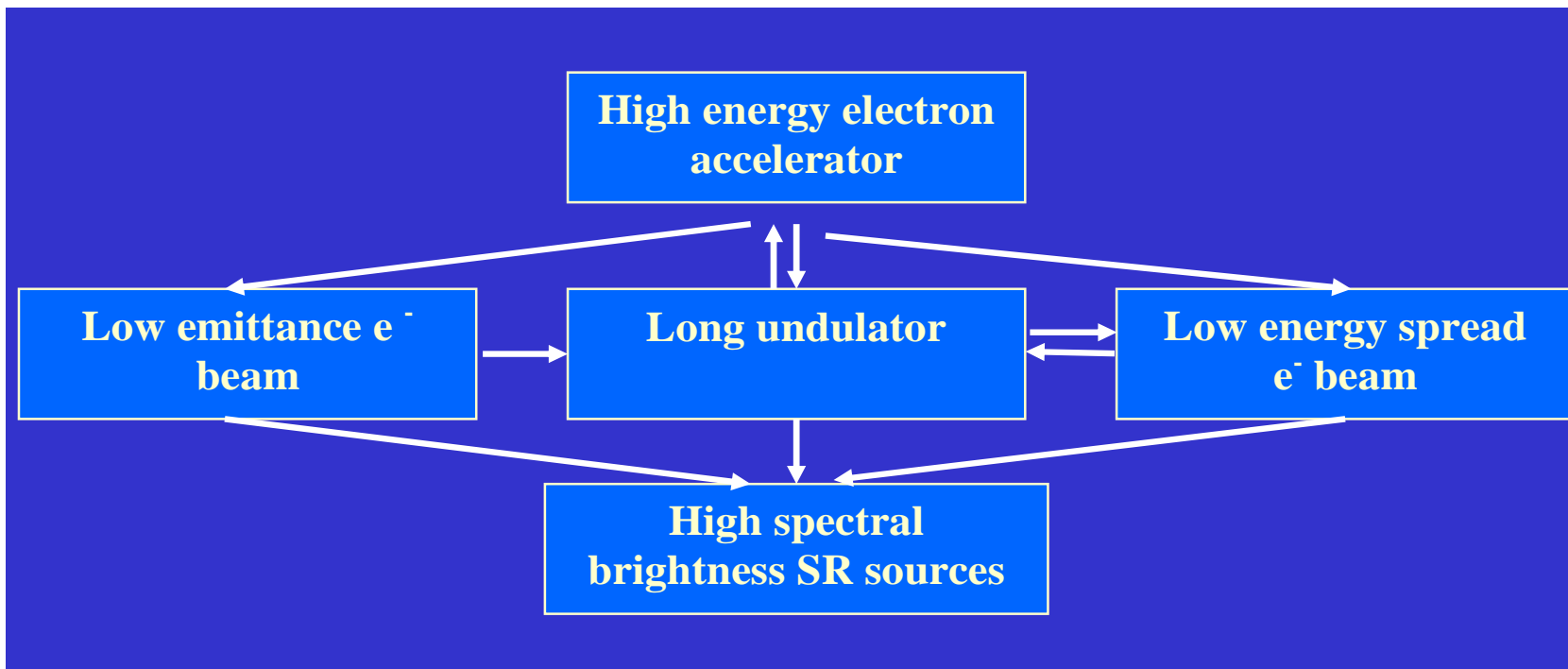

1980	$\epsilon \sim 300 \text{ nmrad}$	$N_u \sim 10$	$\sigma_E/E \sim 10^{-3}$
1990	$\epsilon \sim 30 \text{ nmrad}$	$N_u \sim 10^2$	$\sigma_E/E \sim 10^{-3}$
2000	$\epsilon \sim 3 \text{ nmrad}$	$N_u \sim 10^3$	$\sigma_E/E \sim 10^{-3}$
2010	$\epsilon \sim 1 \text{ nmrad}$	$N_u \sim 10^3$	$\sigma_E/E \sim 10^{-3}$
2020	$\epsilon \sim 0.01 \text{ nmrad}$	$N_u \sim 10^4$	$\sigma_E/E \sim 10^{-4}$

Storage rings

MARS

Steep rise in average brightness

Photons
 $\text{sec} \cdot \text{mm}^2 \cdot \text{mrad}^2 (0.1\% \Delta\lambda/\lambda)$

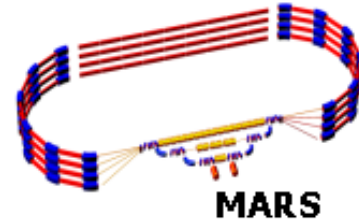
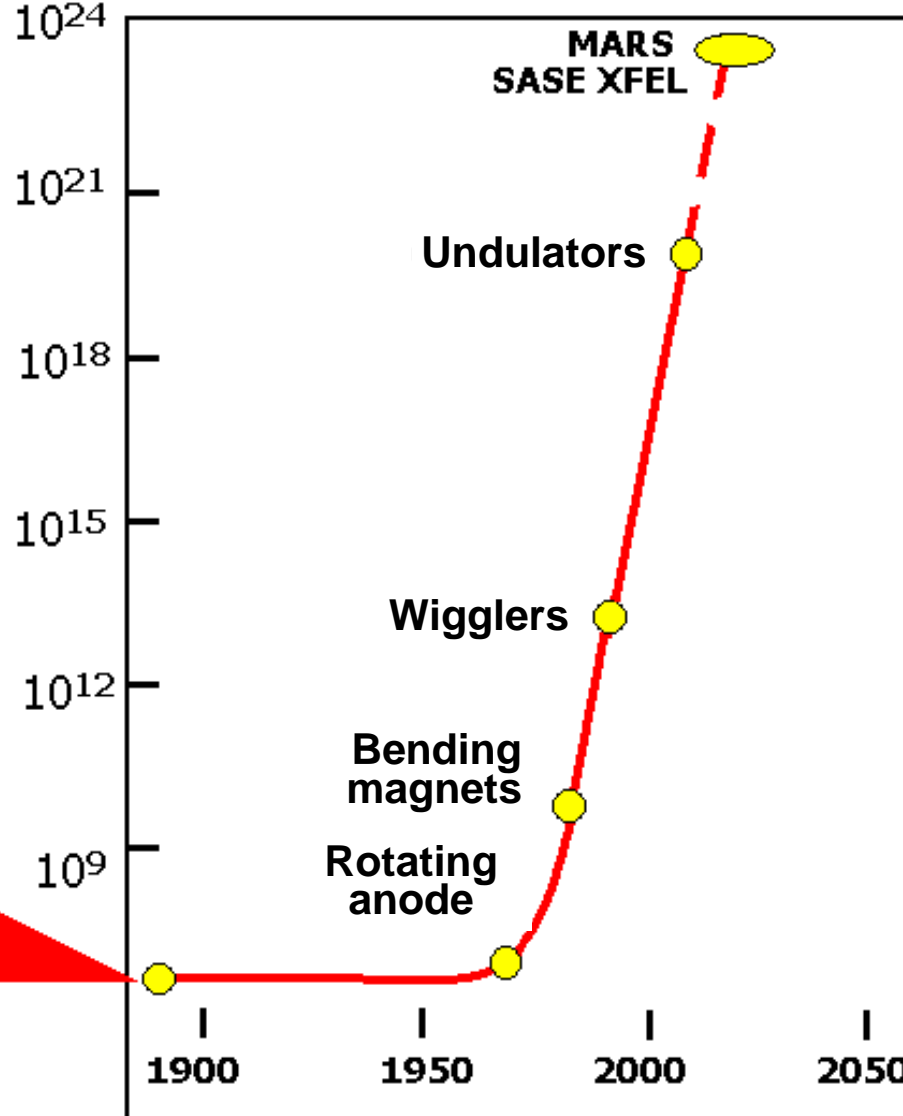

MARS



Spring-8



Siberia-2



VEPP-3 108

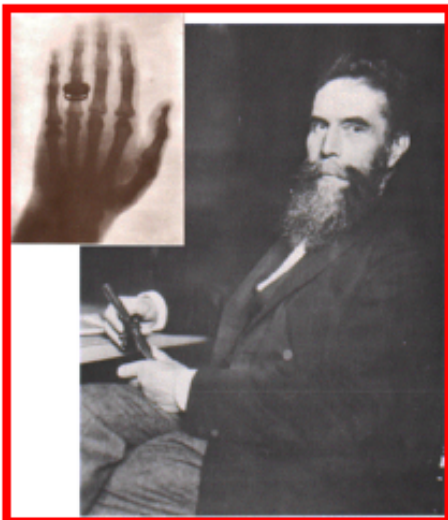

MARS at the RRC “Kurchatov Institute”

- Realization of the “MARS” project at the RRC “Kurchatov Institute” was discussed in detail within the framework of the Russia-Germany meeting “Kurchatov Centre of Synchrotron Radiation and Nanotechnology” (18-19 February 2008, the RRC “Kurchatov Institute”, Moscow).
- A technical proposal and draft project of the SR source MARS under the contract with the RRC “Kurchatov Institute” will be completed at Budker INP till the end of 2011.

The basic dimensions of the MARS main rings

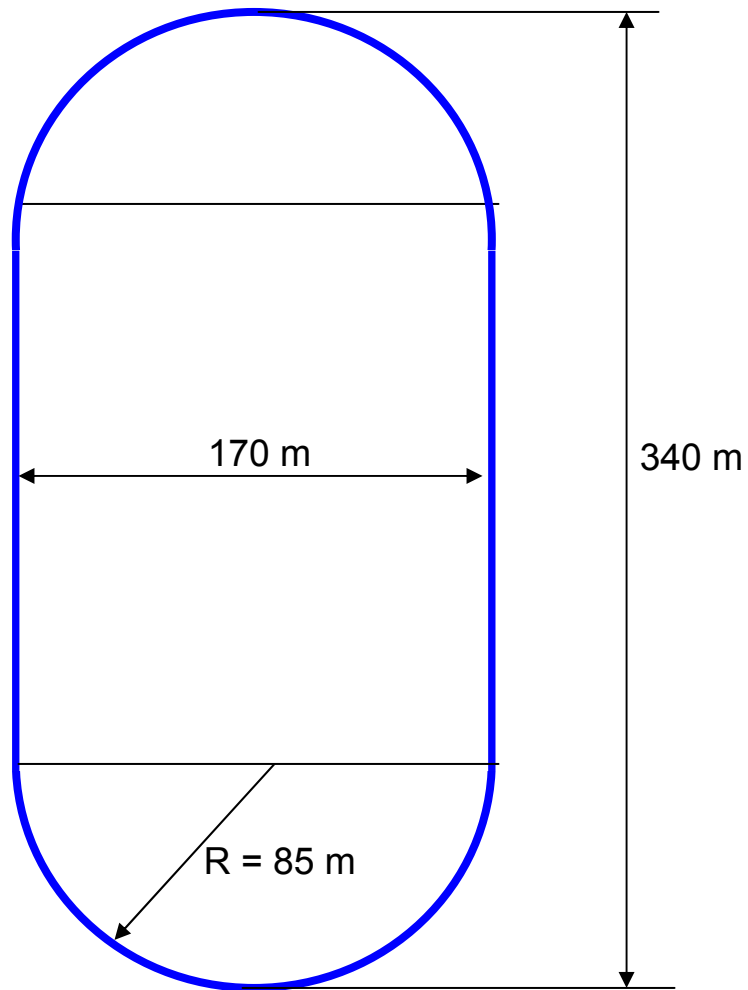

Perimeter = 874 m
Summary length of
4 rings ~ 3.5 km

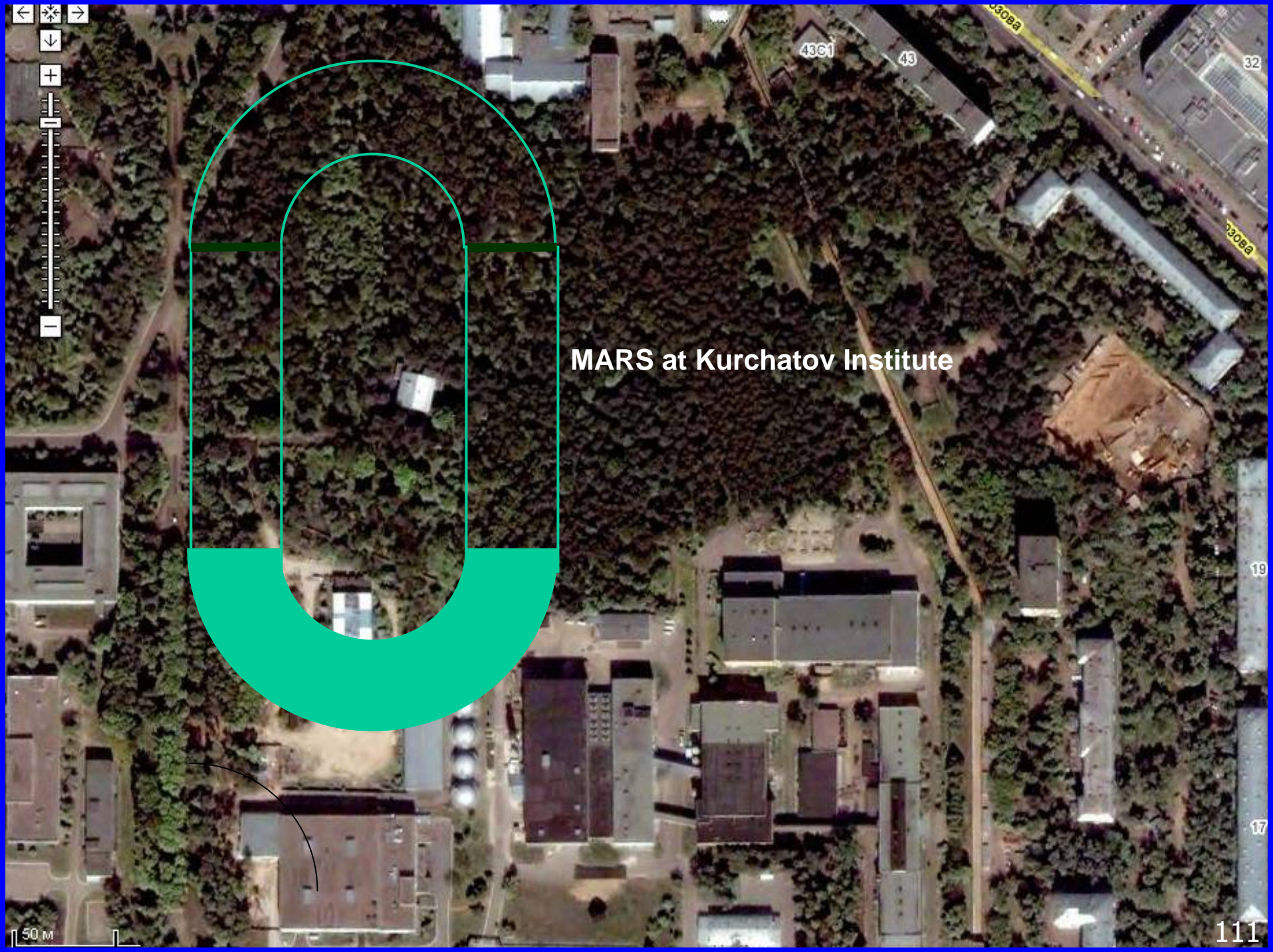

MARS at Kurchatov Institute

50 M

111

The initial scheme of the accelerator-recuperator MARS suffers from a number of shortcomings. The main one is that two beams – under acceleration and deceleration – are circulating simultaneously on all the tracks, which creates two sources of radiation from undulators on those tracks.

For this reason it was suggested recently to turn to an accelerator-recuperator scheme with two acceleration sections, similar to the scheme of the US accelerator CEBAF. Such schemes are considered below.

The simplest variant – accelerator-recuperator

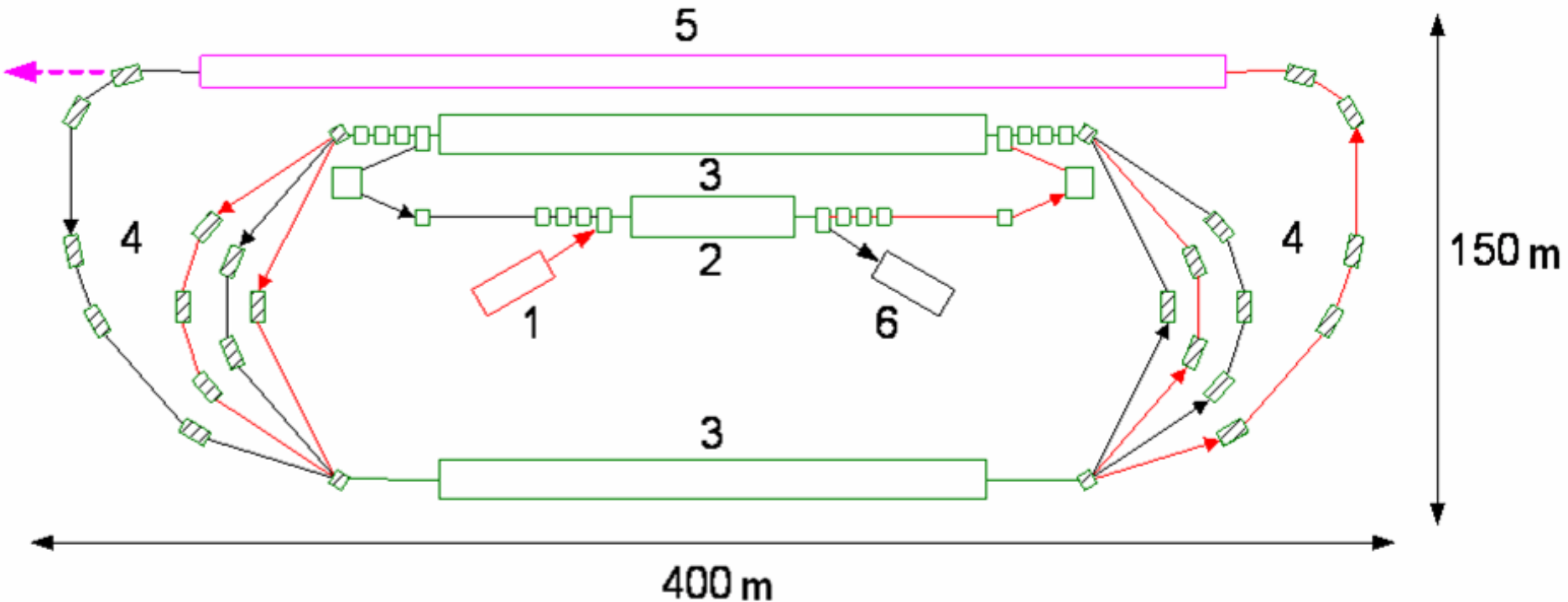

1 – the injector, 2 – the intermediate accelerating RF structure,
3 – the main accelerating RF structures, 4 – the bending magnets,
5 – the undulator, 6 – the beam dump.
The **red** and **black** arrows designate the beams under acceleration
and deceleration (spent), correspondingly.

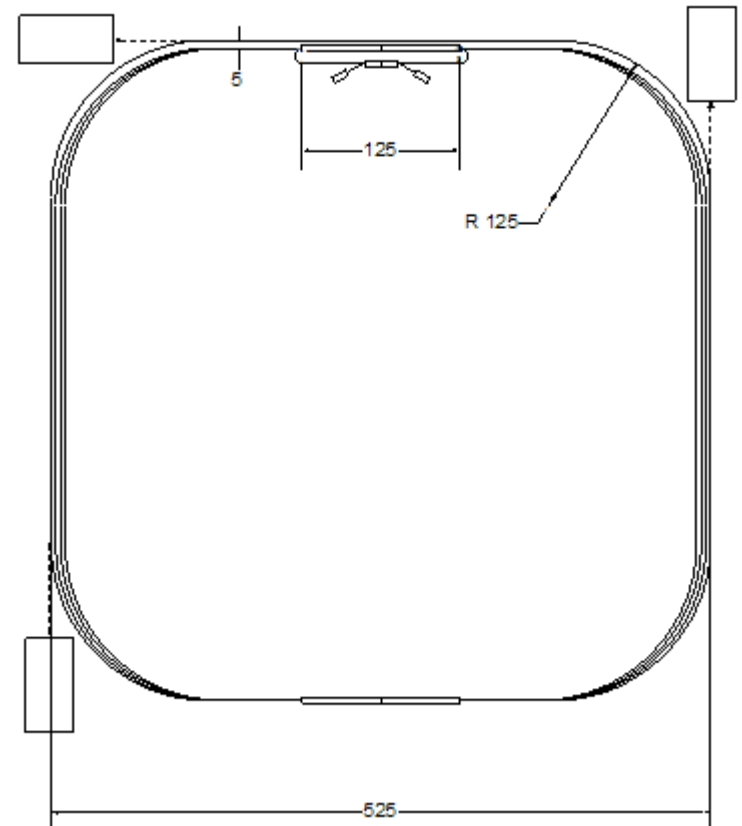
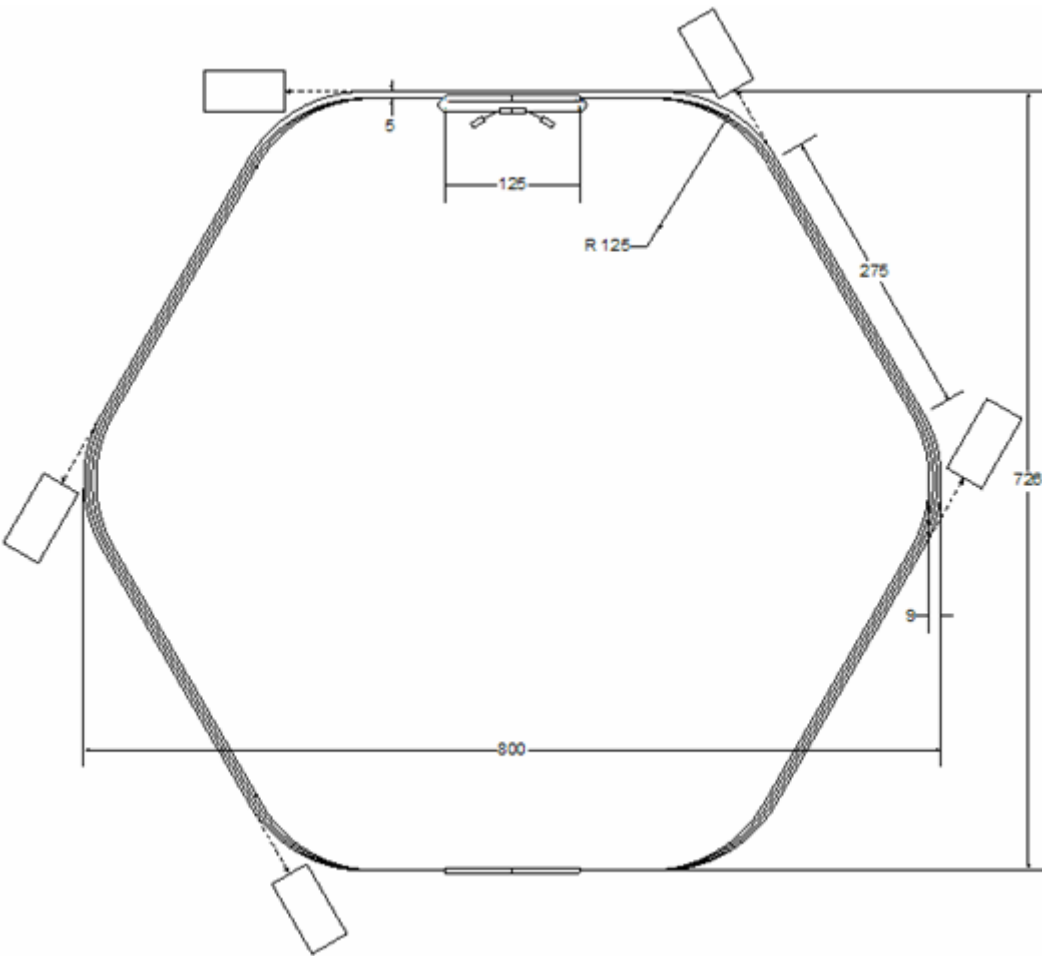

Schemes and sizes of the accelerator-recuperators (m).

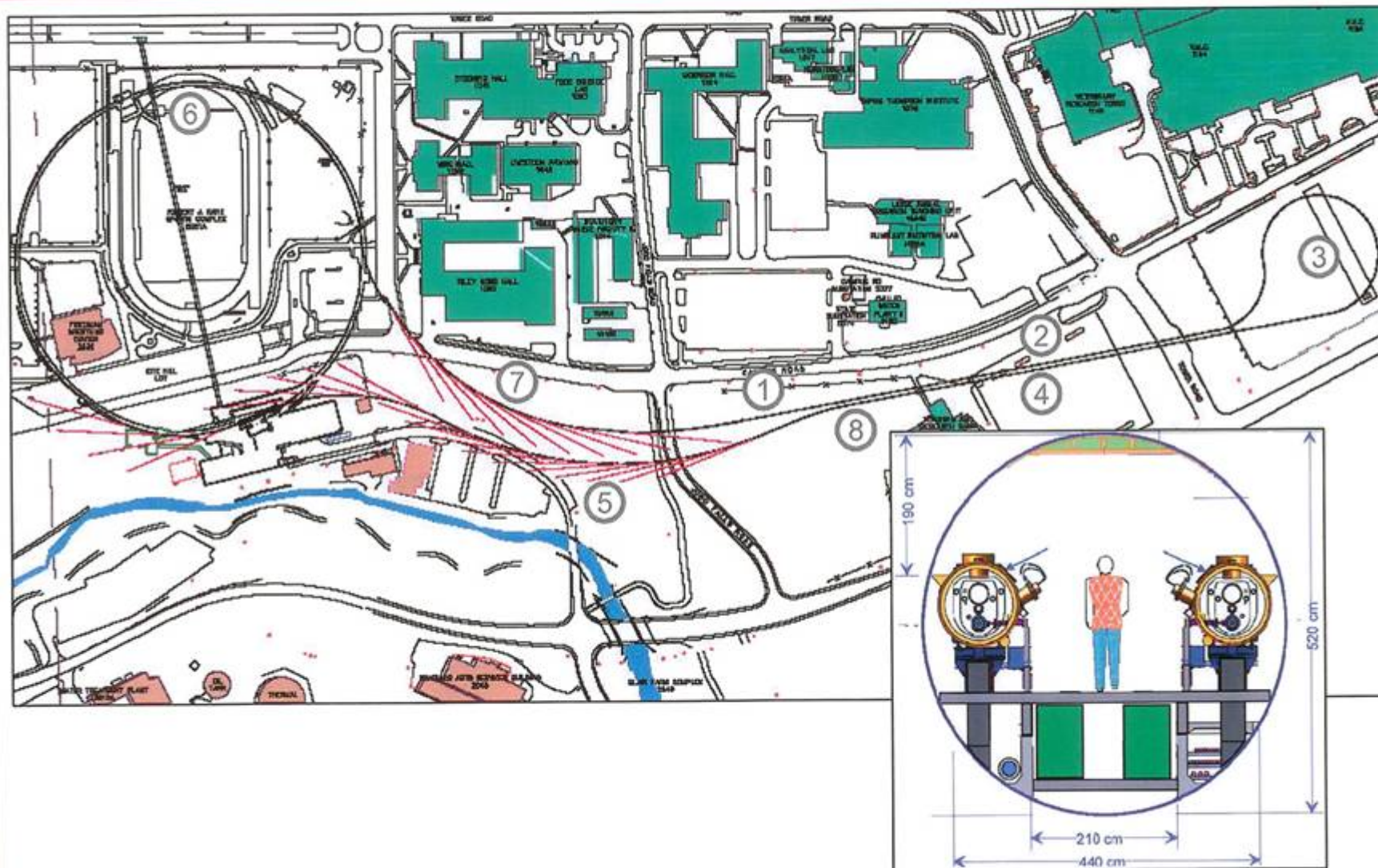

PEP-X ERL Concepts

based on Cornell ERL parameters

$E = 5 \text{ GeV}$

$I = 100 \text{ mA}$

$\epsilon_{x,y} = 30 \text{ pm-rad}$

$\sigma_s = 2 \text{ ps}$

$I = 25 \text{ mA}$

$\epsilon_{x,y} = 8 \text{ pm-rad}$

$\sigma_s = 2 \text{ ps}$

FEL mode: $\sim 0.1 \text{ nC @ } 1 \text{ MHz}$

$\epsilon_{x,y} = \sim 10 \text{ pm-rad}$

$\sigma_s = \sim 10\text{-}100 \text{ fs}$

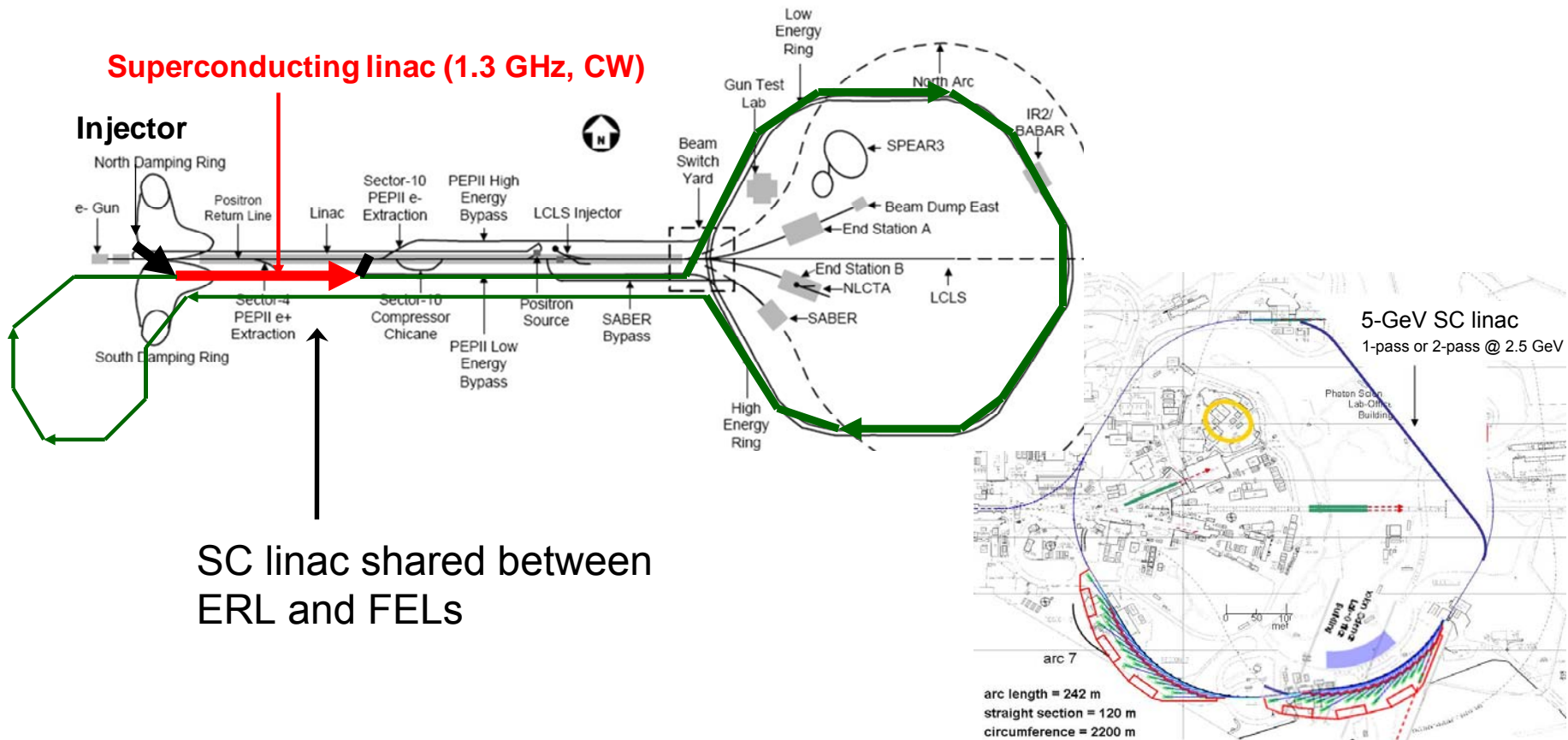

Preliminary Design of 5GeV ERL

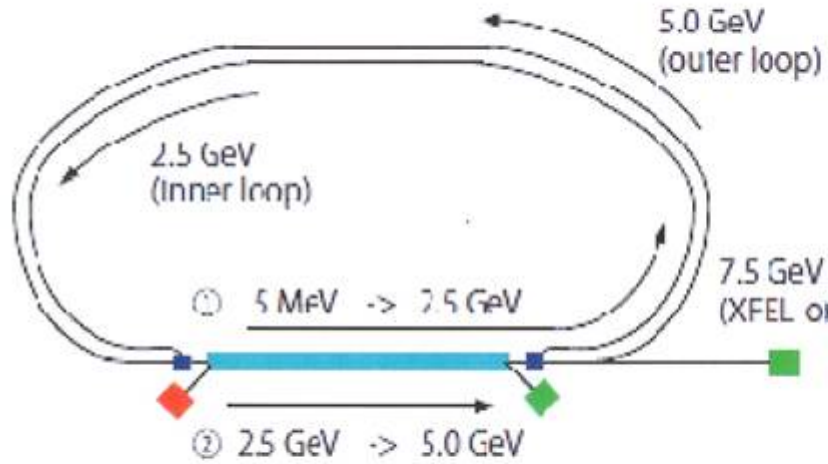

Energy Recovery Mode

- ③ 5.0 GeV → 2.5 GeV
- ④ 2.5 GeV → 5 MeV

XFEL-u Mode

- ③ 5.0 GeV → 7.5 GeV

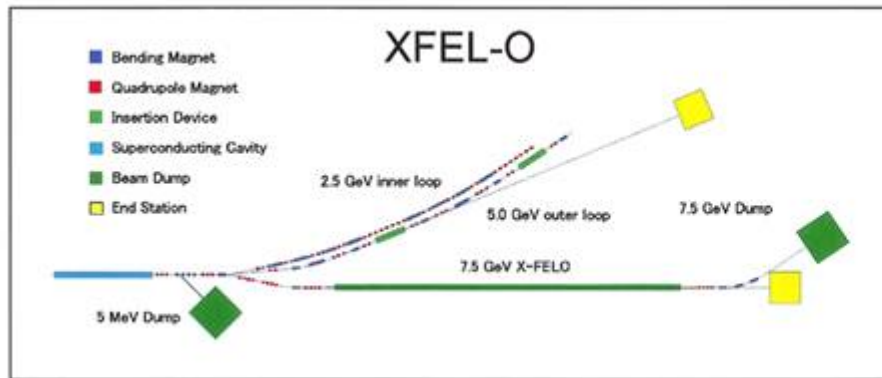

XFELO on CW Linac or ERL

K-J Kim, Y. Shvyd'ko

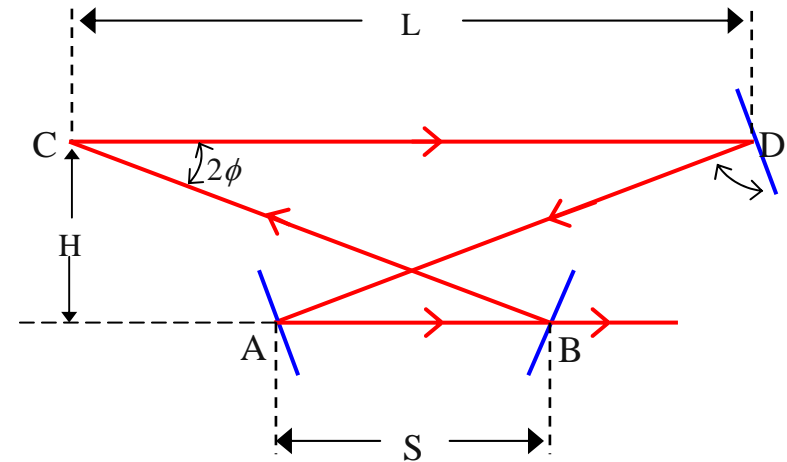
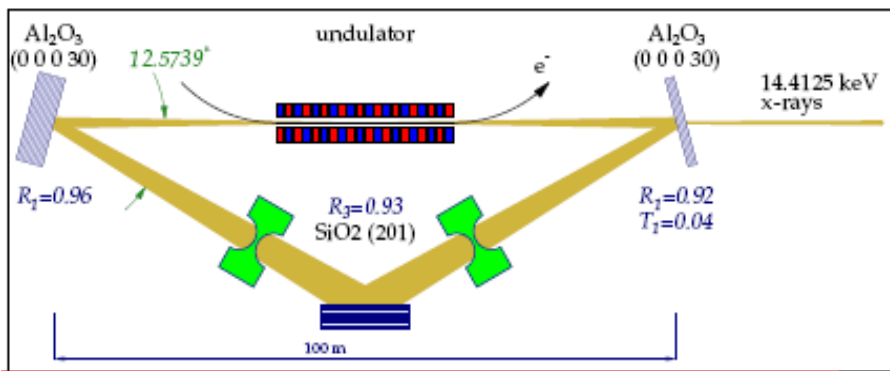
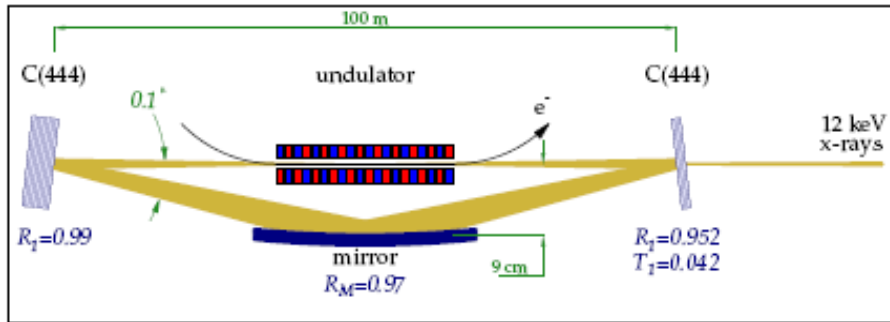
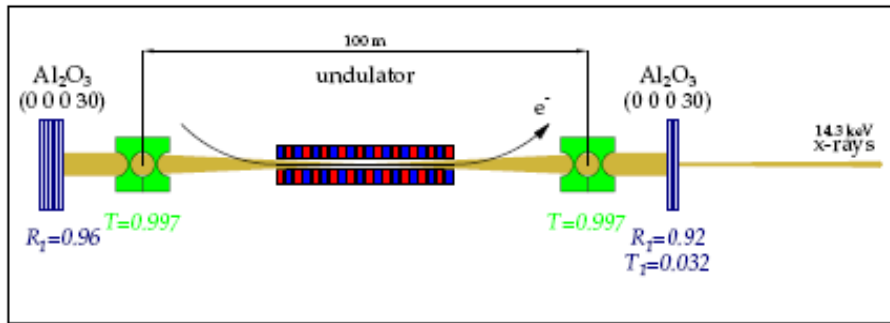

- Tuning: increase H , decrease S , keeping the round trip path length the same
 - $L=100\text{m}$, $H_0=1\text{m}$, $S_0=0.1\text{m} \rightarrow \Delta\varepsilon/\varepsilon=5 \cdot 10^{-4}$ ($H_{\text{max}}=3.3 \text{ m}$)
 - $L=100\text{m}$, $H_0=1\text{m}$, $S_0=2\text{m} \rightarrow \Delta\varepsilon/\varepsilon=1\%$ ($H_{\text{max}}=14.3 \text{ m}$)
- With this scheme, diamond may be used for most cases:
 - With $2\phi_{\text{max}} \sim 60$ degree: (444) for $12 < \varepsilon < 15 \text{ keV}$
 - (220) for $5 < \varepsilon < 6 \text{ keV}$

TESLA XFEL ERL

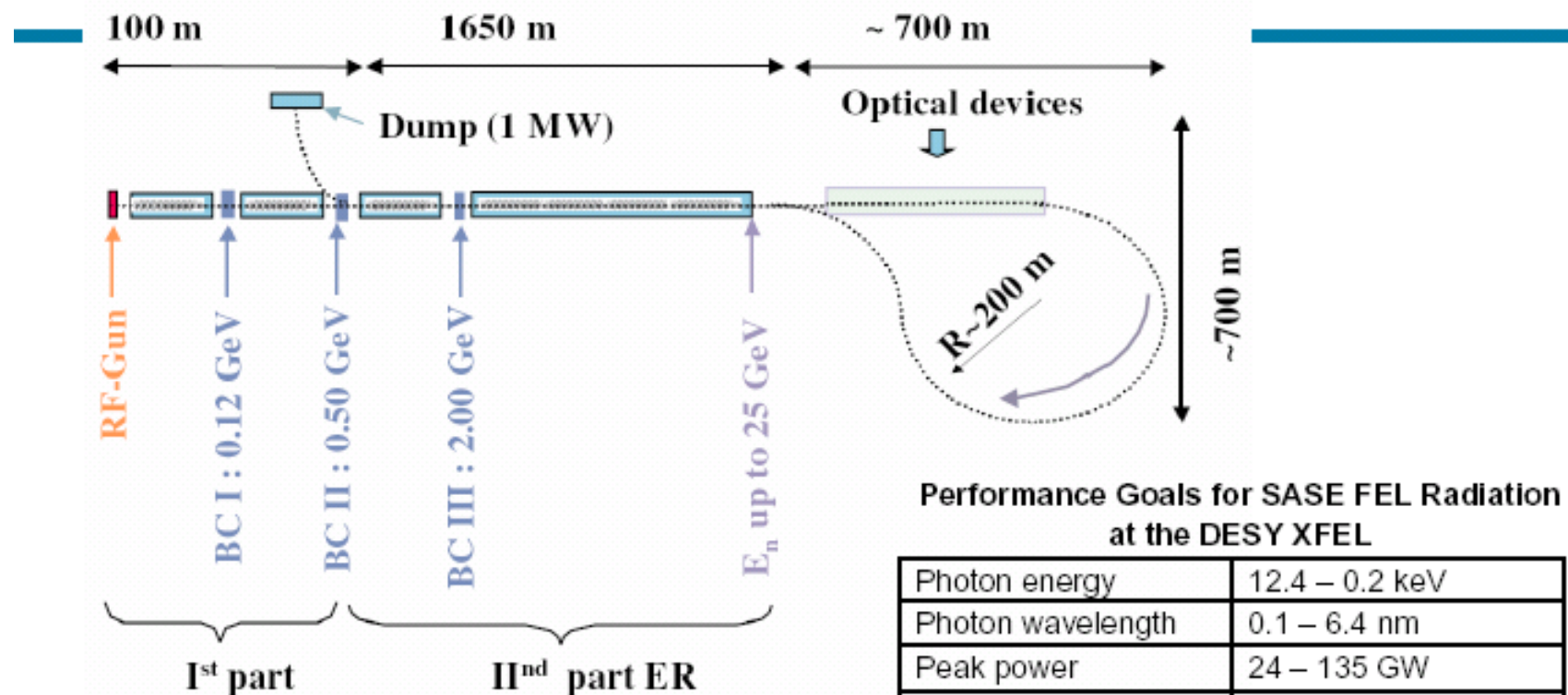

Performance Goals for SASE FEL Radiation at the DESY XFEL

Photon energy	12.4 – 0.2 keV
Photon wavelength	0.1 – 6.4 nm
Peak power	24 – 135 GW
Average power	66 – 800 W
# photons/ pulse	1 – 430 x 10 ¹²
Peak brilliance	5.4 – 0.6 x 10 ³³ **
Average brilliance	1.6 – 0.3 x 10 ²⁵ **
** in units of photons / (s mrad ² mm ² 0.1% b.w.)	

Proposed ER operation would have a rep rate of 1 MHz instead of DESY XFEL rep rate of 10 Hz, increasing the average power and brilliance by a factor of 10⁵



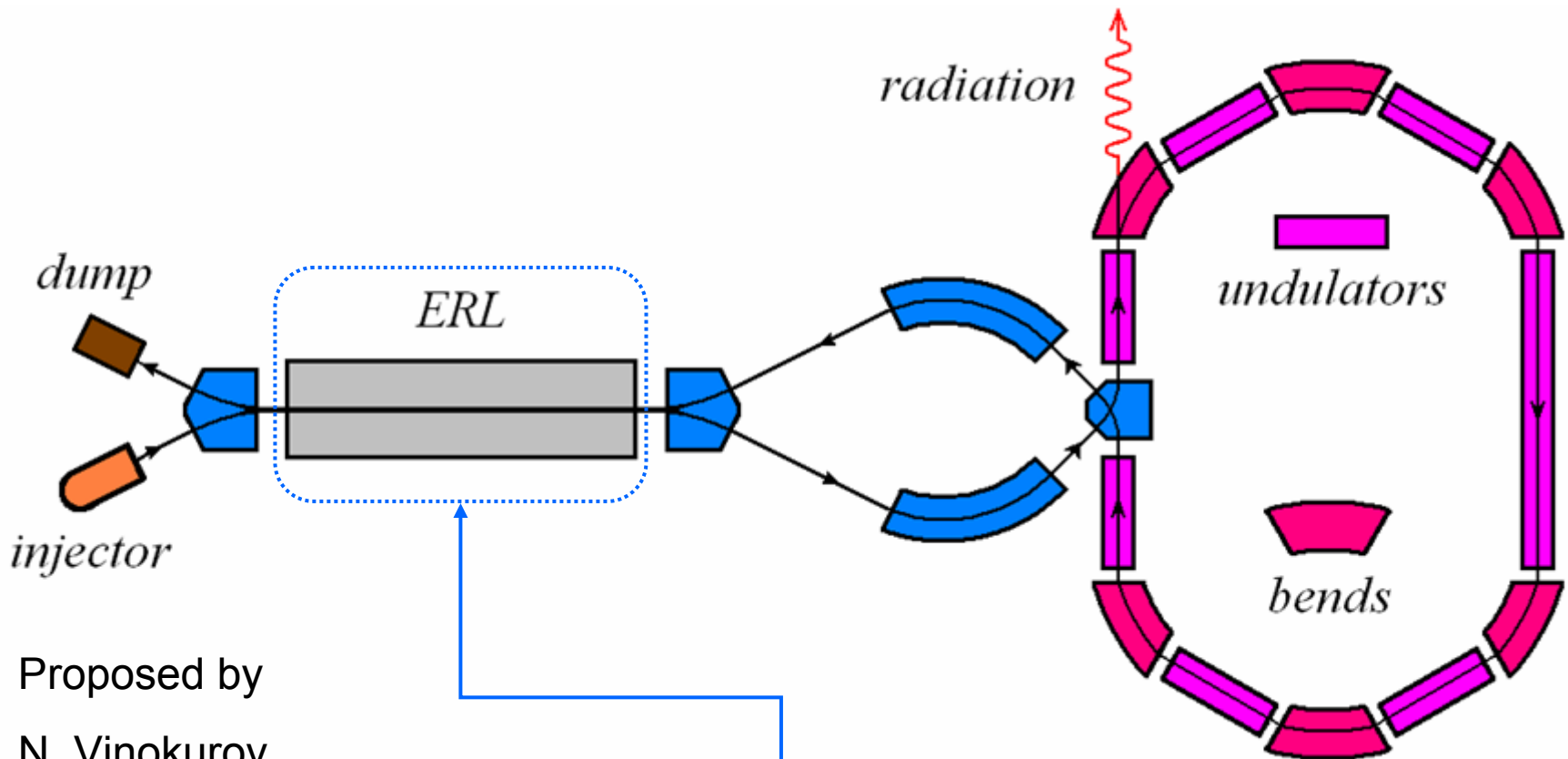

Proposed by
 N. Vinokurov,
 O. Shevchenko (2008)

Ring FEL requires ERL as a source of electron beams as the average beam power can be very high.

8. Comparison of MARS, SASE FEL and XFEL-O.

Diffraction Limited Emittance

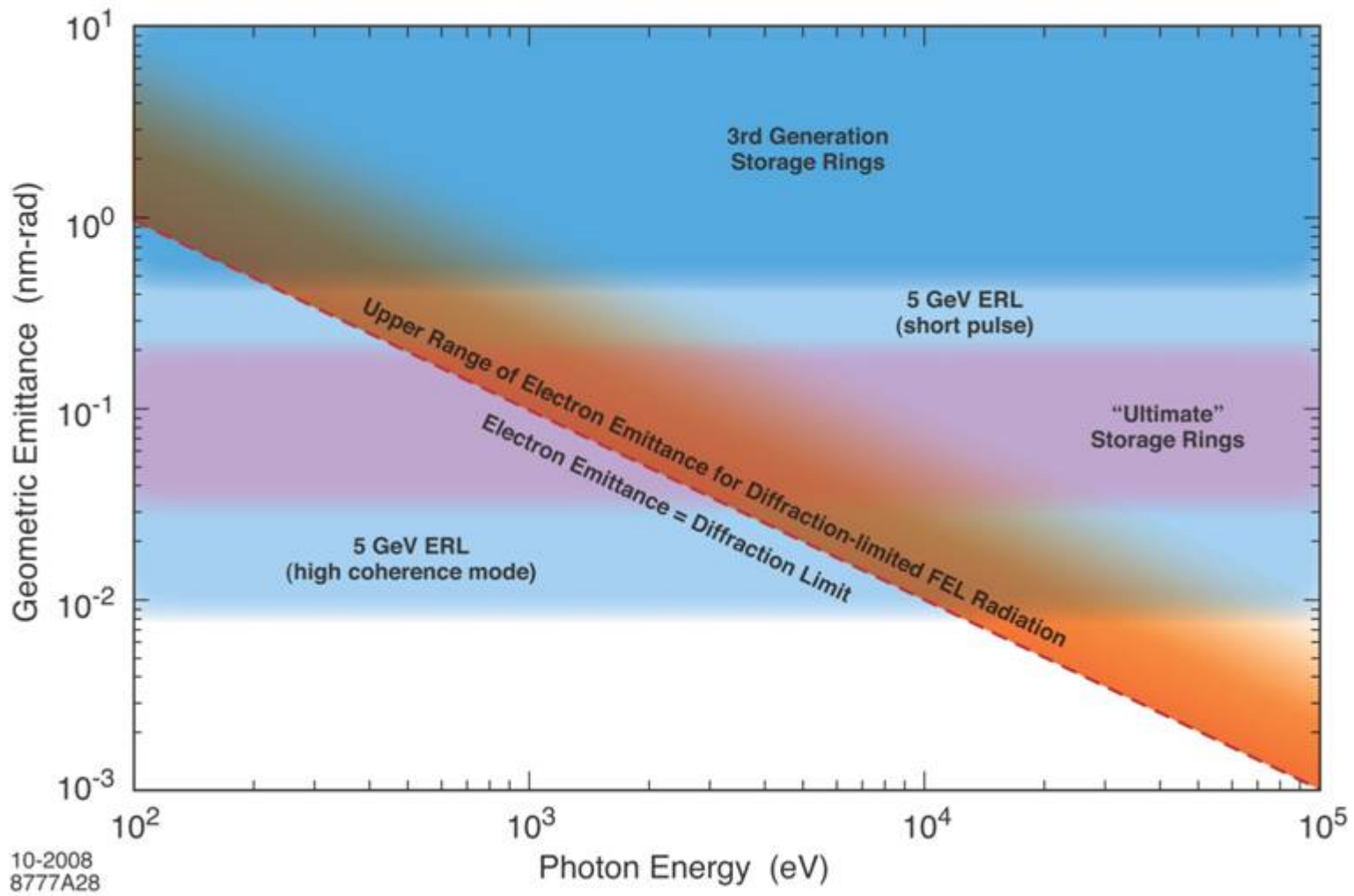

Diffraction limit: $\varepsilon_{ph} = \lambda/4\pi$

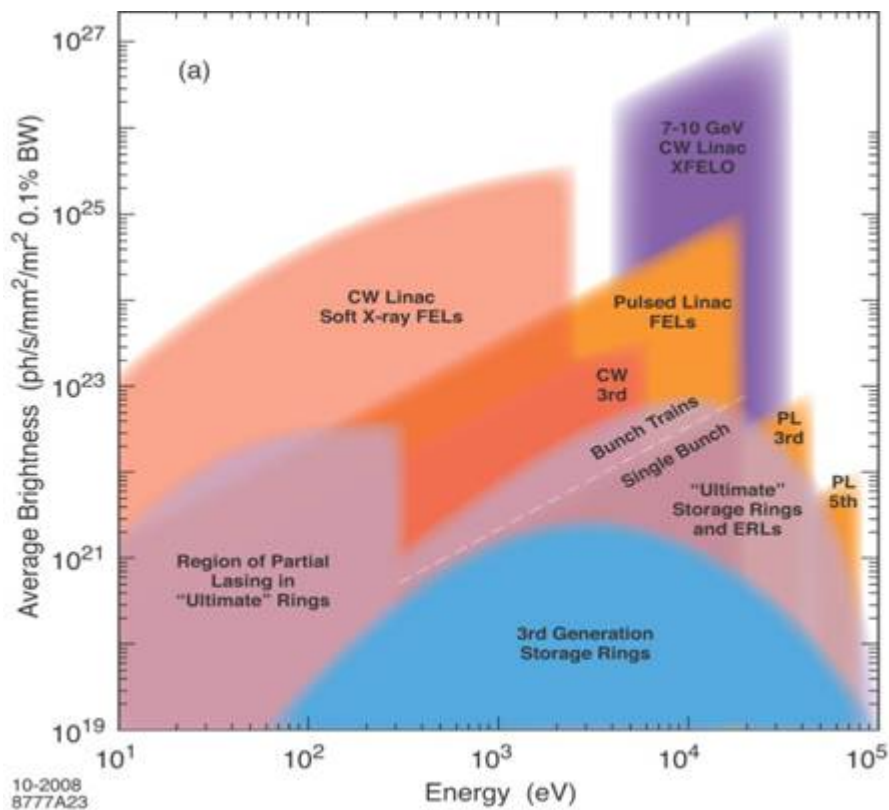

peak brightness

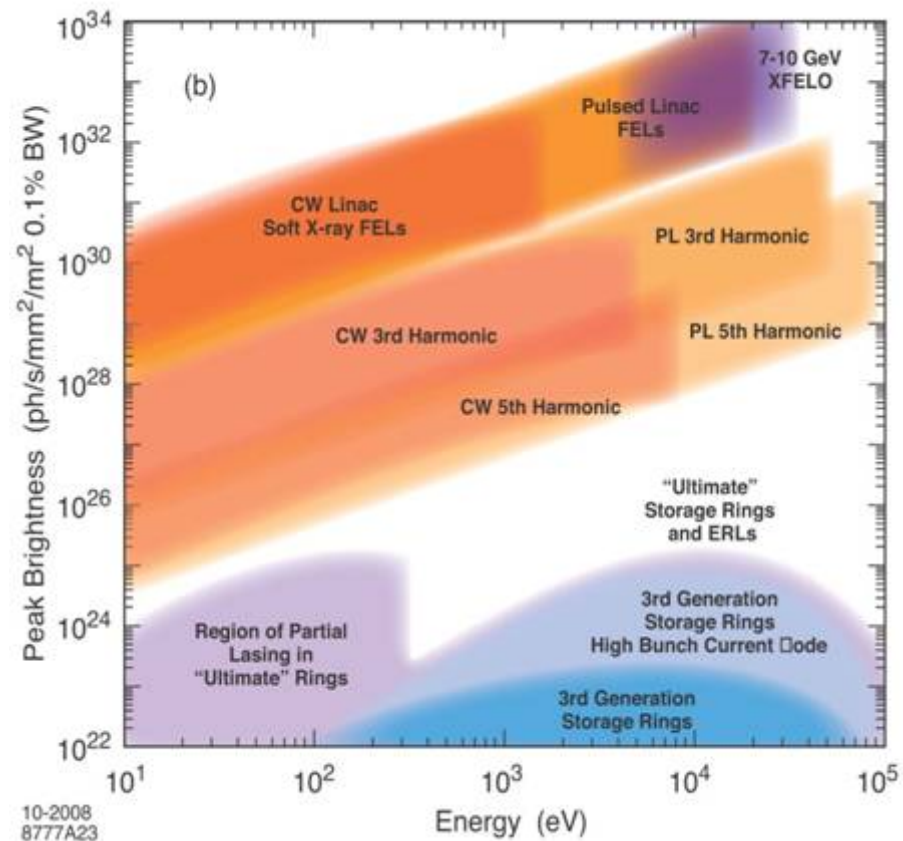

average brightness

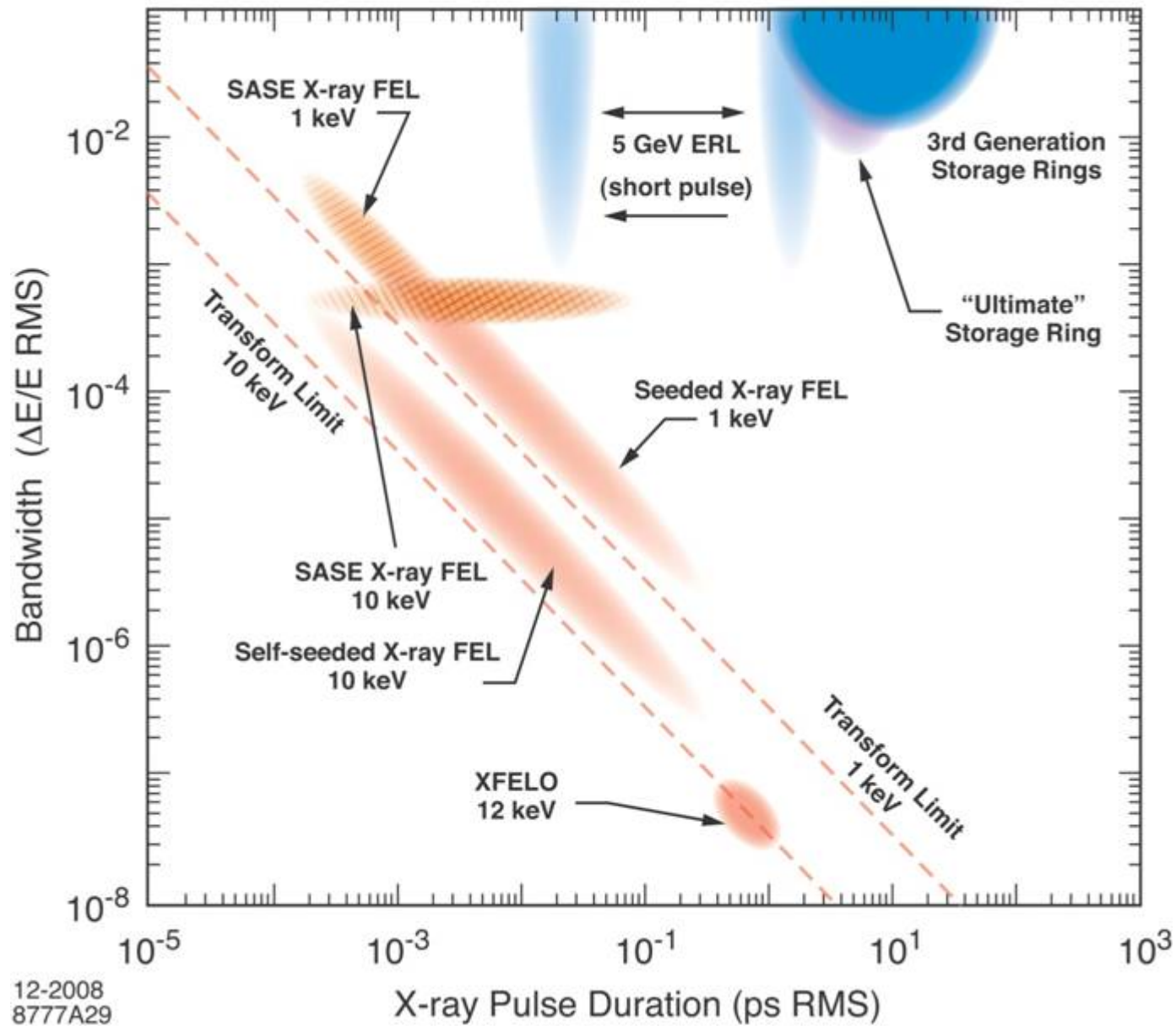

12-2008
8777A29

Conclusion

- ❑ All the requirements to X-ray radiation sources of the 4th generation cannot be met with only one kind of source. The high peak brightness and femtosecond duration of radiation pulses can be attained at the linac based X-ray SASE FEL with a high peak current ($I_p > 1$ kA).
- ❑ All the remaining requirements are easier and cheaper to realize with the use of radiation from long undulators installed on an accelerator-recirculator with energy recovery.

- ❑ At present, the projects of the 4th generation SR sources on the basis of accelerators-recuperators are considered at KEK, Budker INP for RRC “Kurchatov Institut”, Jefferson Laboratory, Cornell University, SLAC-LBL, Brookhaven National Laboratory.
- ❑ The accelerating schemes and most of the systems making the basis of the projects have already been tested at many laboratories (Jefferson Laboratory, DESY, MAMI, LEP, Budker INP, KEK, MAX).

- There are no essential physical obstacles to the development of the 4th generation SR sources on the base of accelerators-recuperators with average current < 10 mA.
- The main problem is the cost of such SR source and its further maintenance.

Acknowledgement

In my lecture I used materials from presentations by several participants of the conferences ERL-2005 and ERL-2007, ERL-2009, whom I want to thank.

My thanks to E. Antokhin, V. Baryshev and N. Vinokurov (Budker INP, Novosibirsk) for their support in the preparation of my lecture.

Thank you for your attention