

RF Power Generation II

Klystrons, Magnetrons and Gyrotrons

Professor R.G. Carter

Engineering Department, Lancaster University, U.K.

and

The Cockcroft Institute of Accelerator Science and Technology

Scope of the lecture:

- The output of an IOT is limited to around 30 kW at 1.3 GHz by the need to use a control grid
- At higher frequencies and higher powers the beam must be bunched in another way
- Klystrons
- Multipactor discharge
- Other high power sources
 - SLAC Energy Doubler
 - Magnetrons
 - Gyrotrons
- State of the art

Velocity modulation

- An un-modulated electron beam passes through a cavity resonator with RF input
- Electrons accelerated or retarded according to the phase of the gap voltage: Beam is velocity modulated:
- As the beam drifts downstream bunches of electrons are formed as shown in the Applegate diagram
- An output cavity placed downstream extracts RF power just as in an IOT
- This is a simple 2-cavity klystron

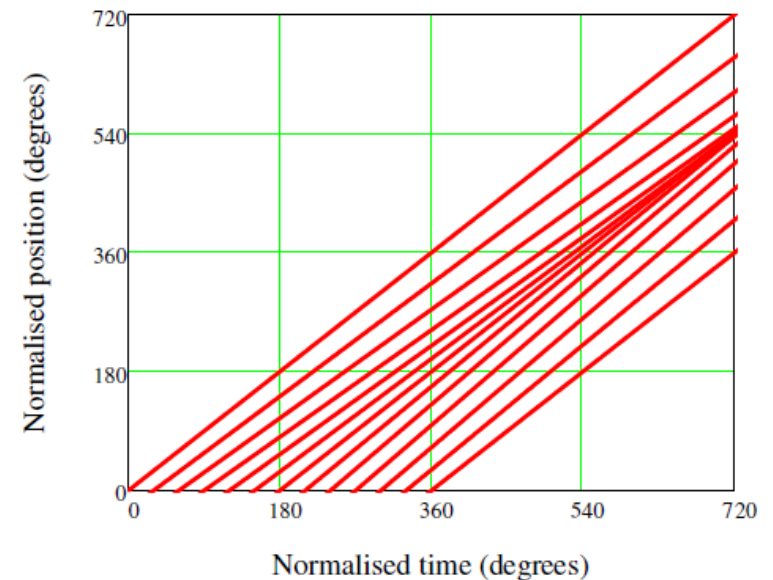
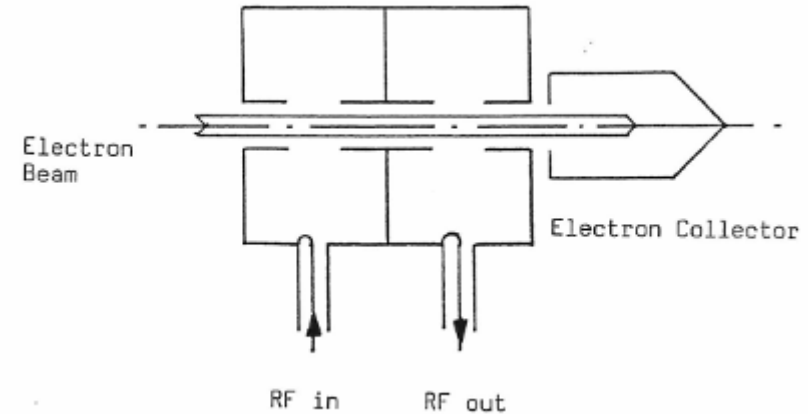

Multi-cavity klystron

- Additional cavities are used to increase gain, efficiency and bandwidth
- Bunches are formed by the first (N-1) cavities
- Power is extracted by the Nth cavity
- Electron gun is a space-charge limited diode with perveance given by

$$K = \frac{I_0}{V_0^{\frac{3}{2}}}$$

- $K \times 10^6$ is typically 0.5 - 2.0
- Beam is confined by an axial magnetic field

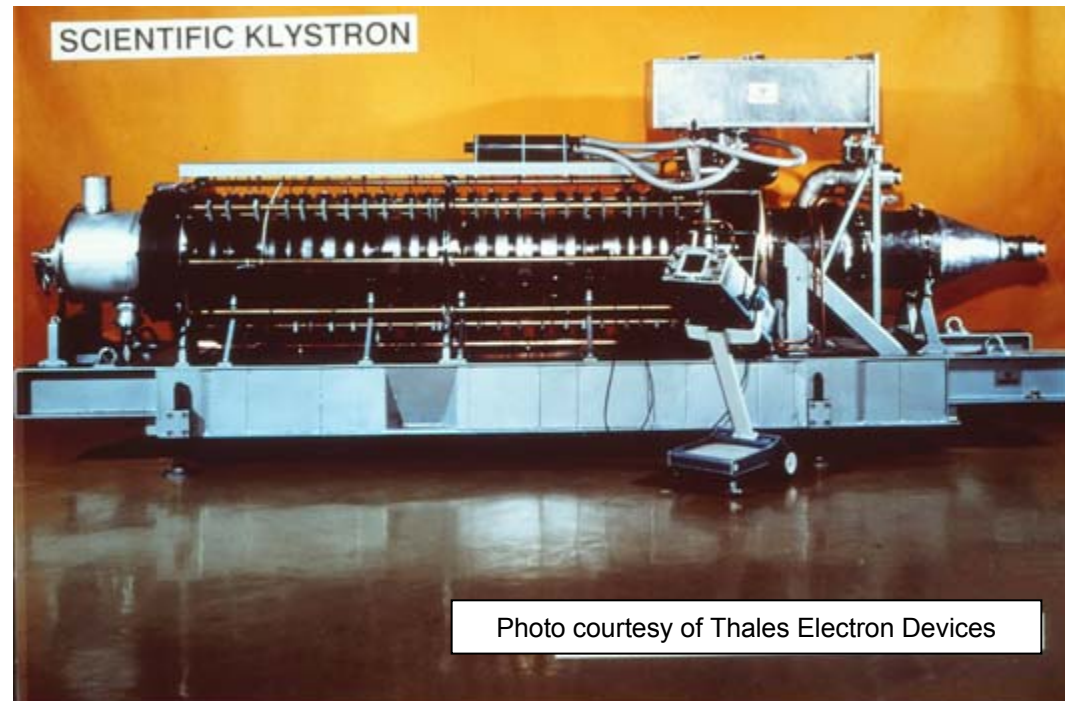
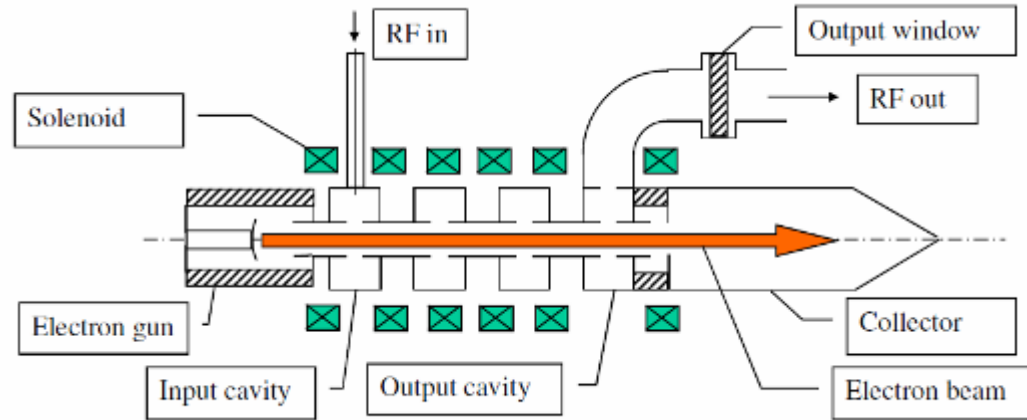

Typical Applegate diagram

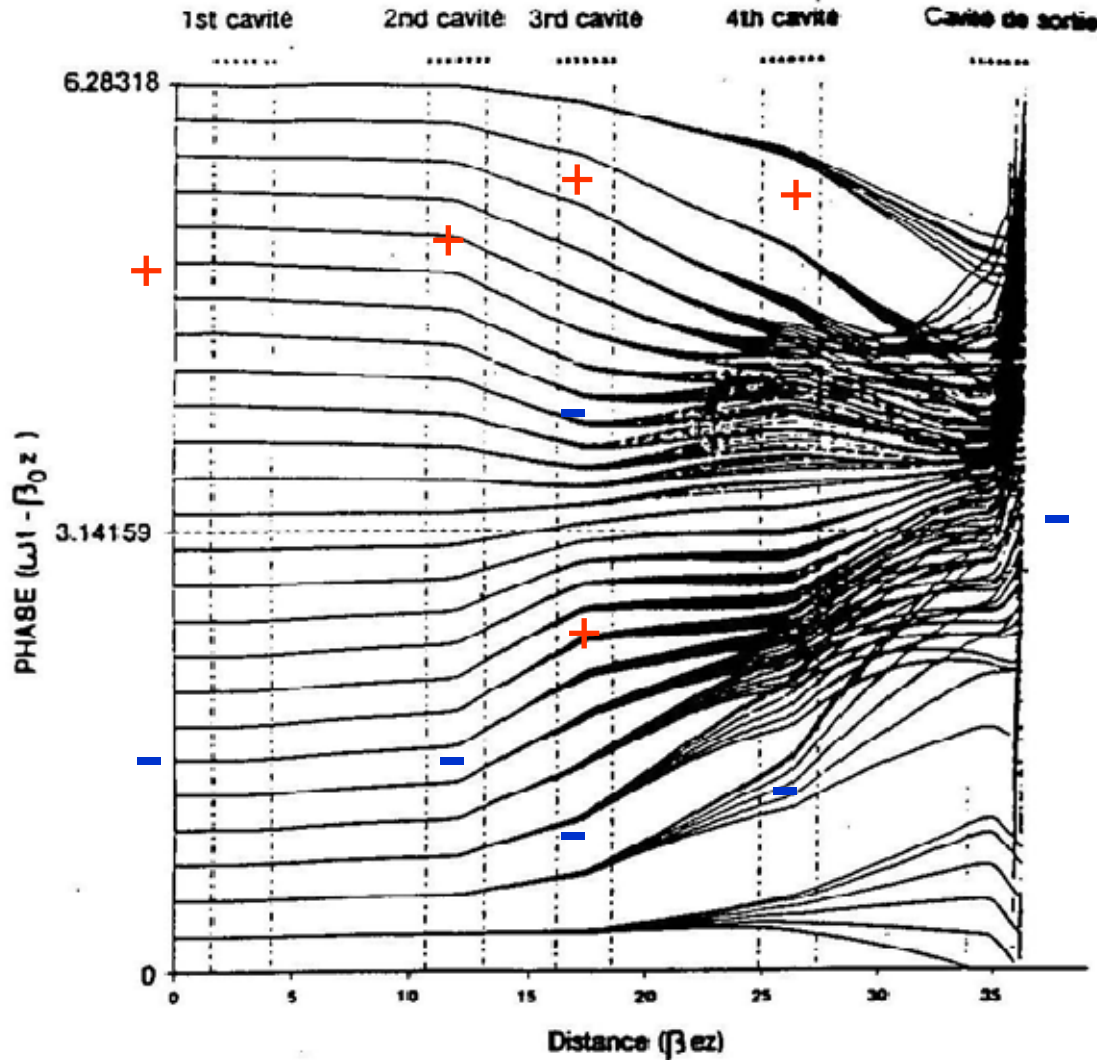

- Distance and time axes exchanged
- Average beam velocity subtracted
- Intermediate cavities detuned to maximise bunching
- Cavity 3 is a second harmonic cavity
- Space-charge repulsion in last drift section limits bunching
- Electrons enter output gap with energy $\sim V_0$

Image courtesy of Thales Electron Devices

Output saturation

- Non-linear effects limit the power at high drive levels and the output power saturates
- Electrons must have residual energy $> 0.1V_0$ to drift clear of the output gap and avoid reflection
- RF beam current increases as bunch length decreases.
 - Theoretical maximum $I_1 = 2I_0$ when space-charge is low
 - Maximum I_1 decreases with increasing space-charge
- Second harmonic cavity may be used to increase bunching
- Maximum possible efficiency with second harmonic cavity is approximately

$$\eta_e = 0.85 - 0.2 \times 10^{-6} K$$

- Efficiency decreases with increasing frequency because of increased losses and design trade-offs

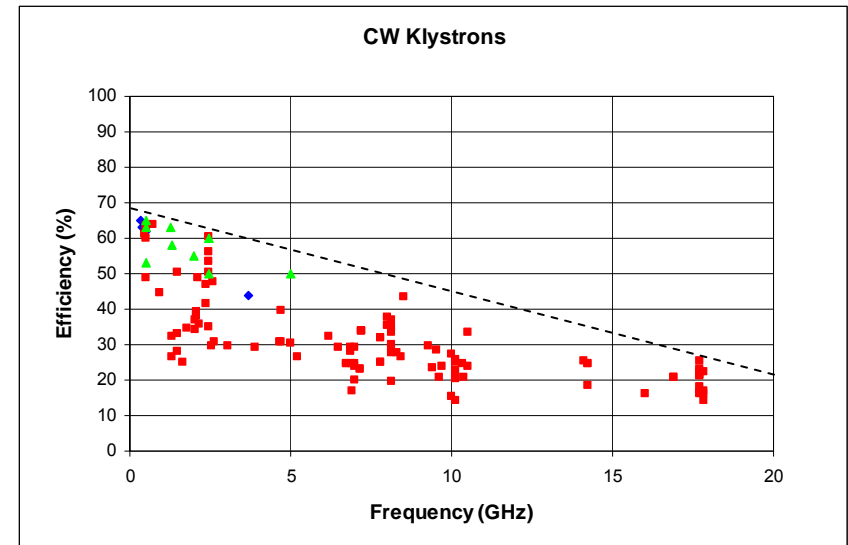
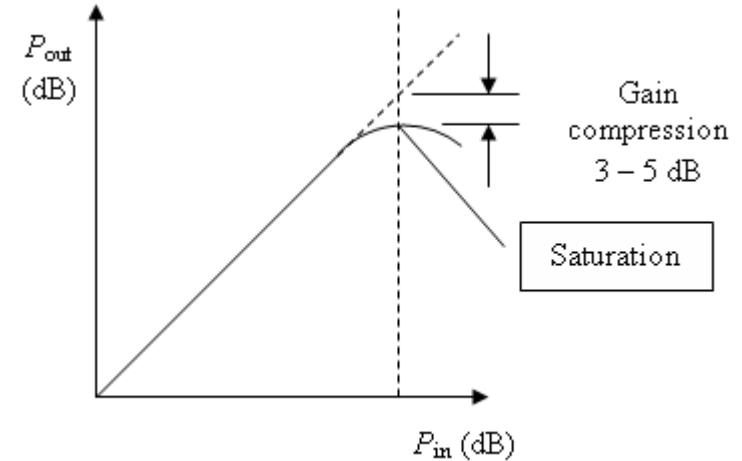

Effect of output match

- Reflected power changes the amplitude and/or phase of the output gap voltage
- Rieke diagram shows output power as a function of match at the output flange
- Shaded region forbidden because of voltage breakdown and/or electron reflection
- Output mismatch can also cause:
 - Output window failure
 - Output waveguide arcs
- A Circulator is needed to protect against reflected power

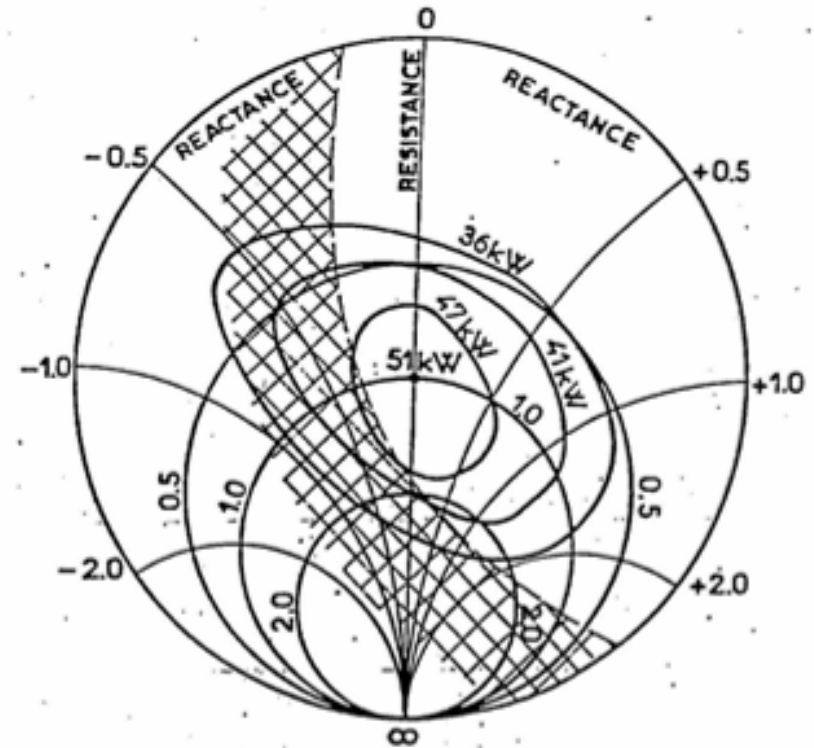
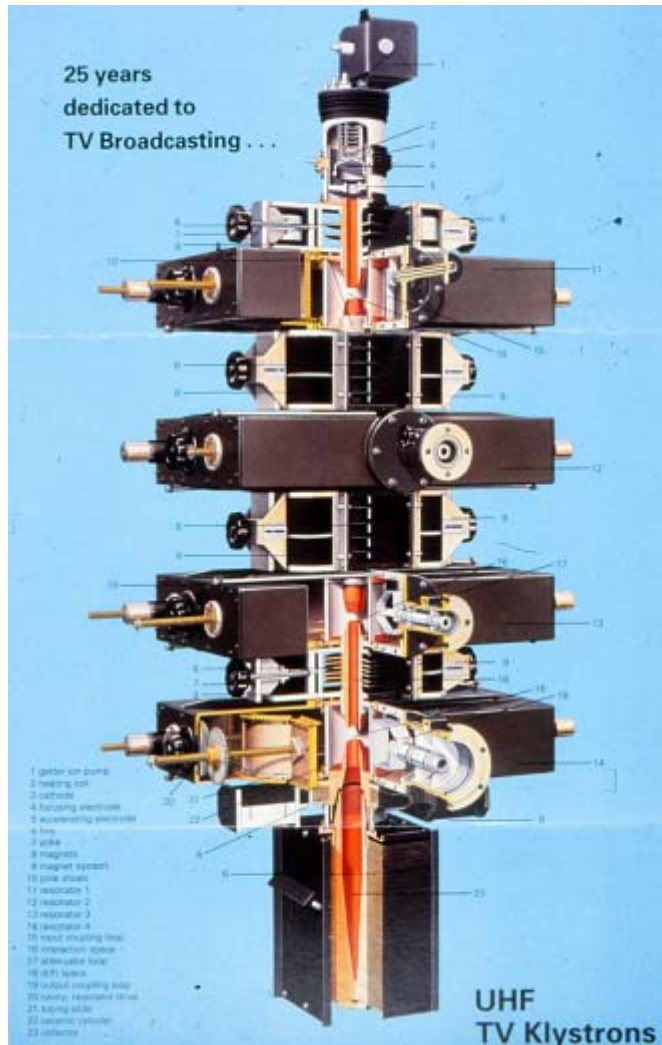

Image courtesy of Thales Electron Devices

UHF TV klystrons



Photos courtesy of Phillips

- Frequency 470 - 860 MHz
- Power 10 - 70 kW
- Gain 30 - 40 dB
- Efficiency 40 – 50%
- Beam control by modulating anode
- 4 or 5 tunable internal or external cavities



CERN SPS 450kW 800MHz amplifier

Collector depression

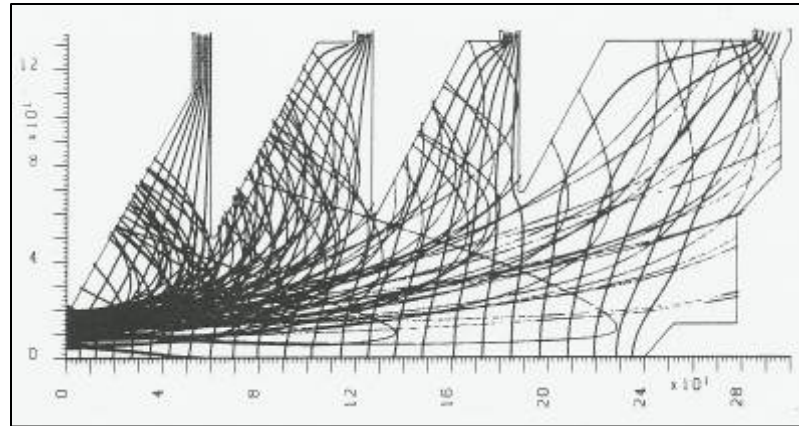
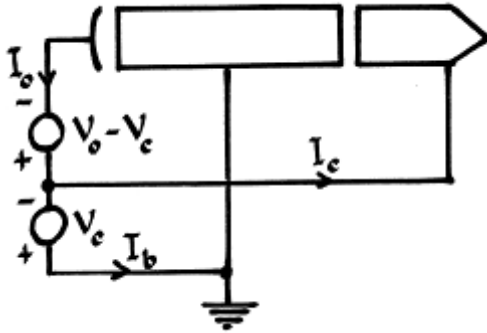

$$P_{DC} = I_C (V_0 - V_C) + I_b V_0 = I_0 V_0 - I_C V_C$$

$$\eta = \frac{P_{RF}}{I_0 V_0 - I_C V_C}$$

- Efficiency increases with number of stages: realistic maximum is 4 – 5
- Adds to the complexity and cost of the tube
- High voltage electrodes are difficult to cool
- Can also be used with IOTs

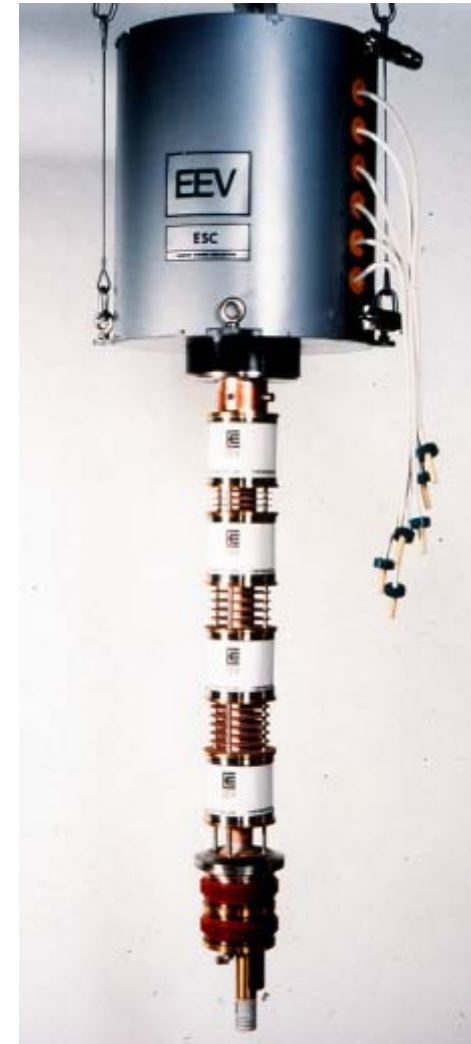

Accelerator klystrons



Frequency	508 MHz
Beam	90 kV; 18.2A
Power	1 MW c.w.
Efficiency	61%
Gain	41 dB

Photos courtesy of Phillips

Accelerator klystrons



Second harmonic cavity

Output cavity and coupler

Window components

Photos courtesy of Phillips

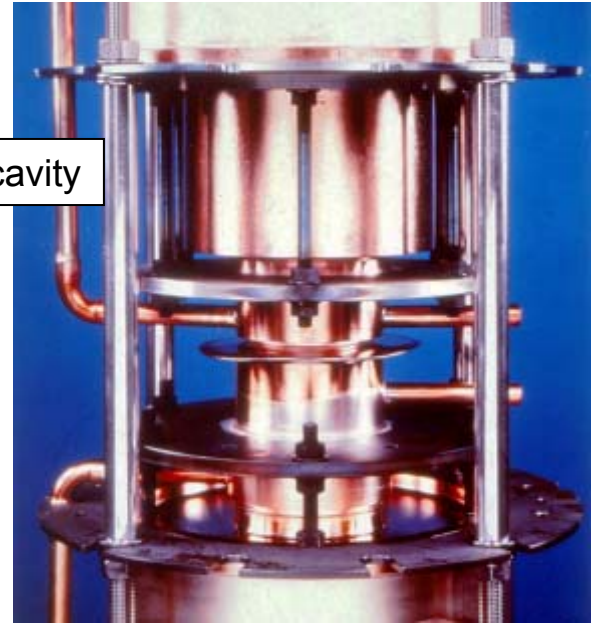

CW Klystrons

Frequency	352	700	3700	MHz
Beam voltage	100	92	60	kV
Beam current	19	17	20	A
RF output power	1.3	1.0	0.7	MW
Efficiency	67	65	44	%

Pulsed Klystrons

Frequency	2.87	3.0	11.4	GHz
Beam voltage	475	590	506	kV
Beam current	620	610	296	A
RF output power	150	150	75	MW
Efficiency	51	42	50	%

Note: Breakdown voltage is higher for short pulses than for DC

Multiple beam klystrons

- To deliver high power with high efficiency requires low perveance
- High beam voltage is not desirable
- Several low perveance klystrons combined in one vacuum envelope as a multiple-beam klystron

Frequency	1300 MHz
Beam	115 kV; 133 A
Power	9.8 MW peak
Efficiency	64 %
Gain	47 dB
Pulse	1.5 msec

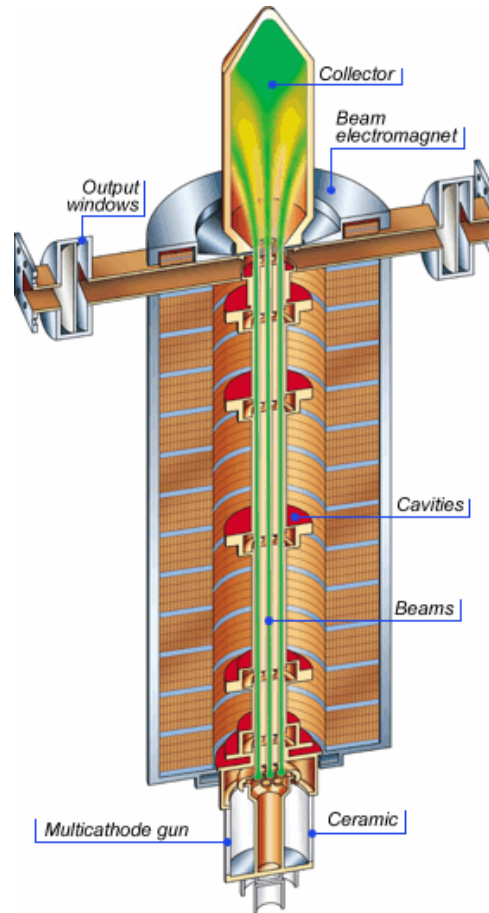

Images courtesy of Thales Electron Devices



Klystron performance limited by:

- Voltage breakdown
 - Electron gun
 - Output gap
- Cathode current density
- Output window failure caused by
 - Reflected power
 - Vacuum arcs
 - Multipactor discharge
 - X-ray damage
- Heat dissipation

Multipactor discharge

- Resonant RF vacuum discharge sustained by secondary electron emission
- One or two surfaces involved
- Multiple modes
- Signs of multipactor:
 - Heating
 - Changed r.f. performance
 - Window failure
 - Light and X-ray emission
- Multipactor on dielectric surfaces does not require RF field
- Multipactor can sometimes be suppressed by
 - Changing shape of surface
 - Surface coatings
 - Static electric and magnetic fields

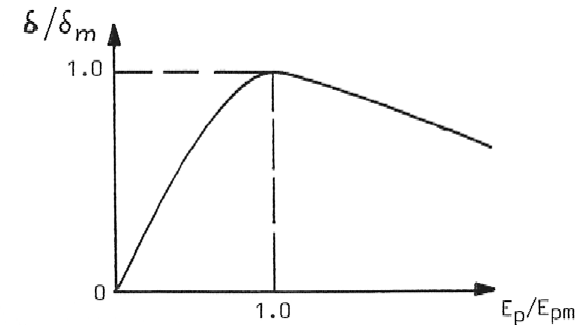

Secondary electron emission constants		
	δ_m	E_{pm} (Volts)
Copper	1.3	600
Platinum	1.8	800
Carbon black	0.45	500
Aluminium Oxide	2.35	500

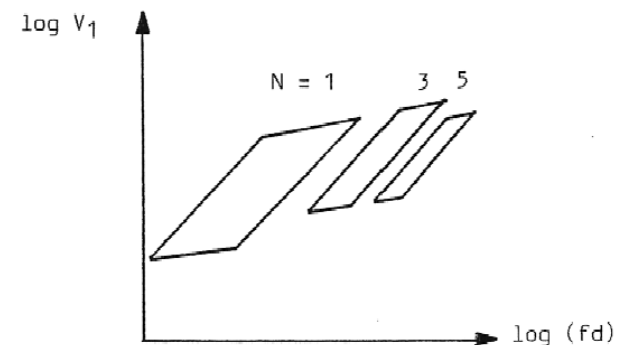

The SLAC Energy Doubler (SLED)

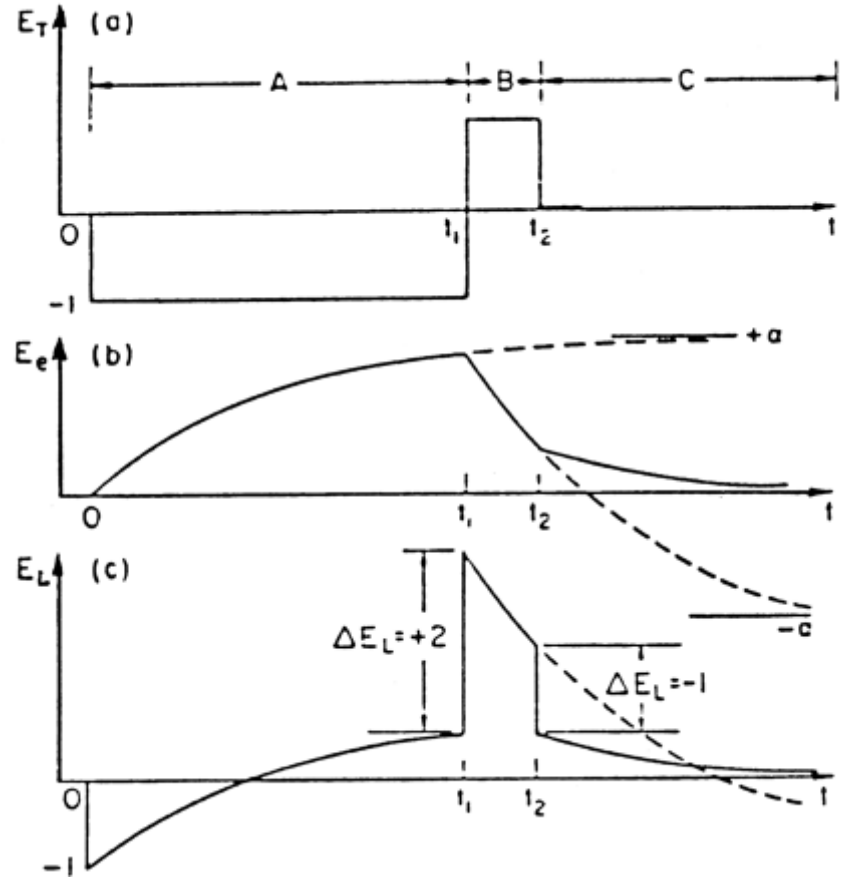
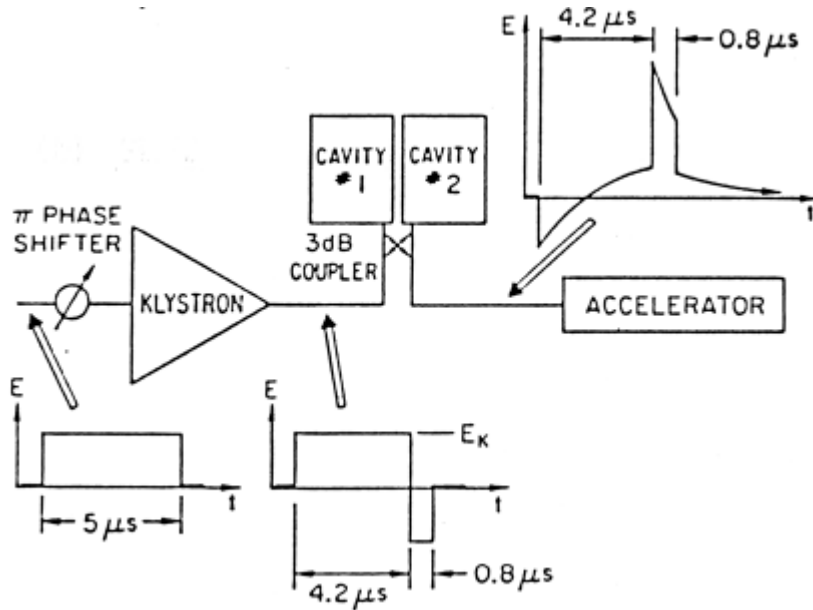

- a) Power transmitted by the cavities (E_T)
- b) Power re-radiated by the cavities (E_e) (antiphase)
- c) Sum of transmitted and radiated power

Note: No power is reflected to the klystron

Magnetrons

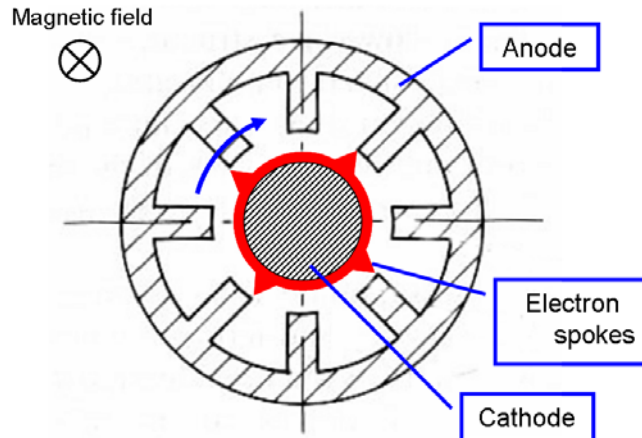

- Interaction in crossed electric and magnetic fields
- Free-running oscillator: Efficiency up to 90%
- Frequency
 - Is not stable enough for use in most accelerators
 - Coarse control of frequency by controlling the current
 - Frequency locked by injecting radio-frequency power $\sim 0.1\%$ of output power
- Locked magnetrons could be suitable for use in accelerators

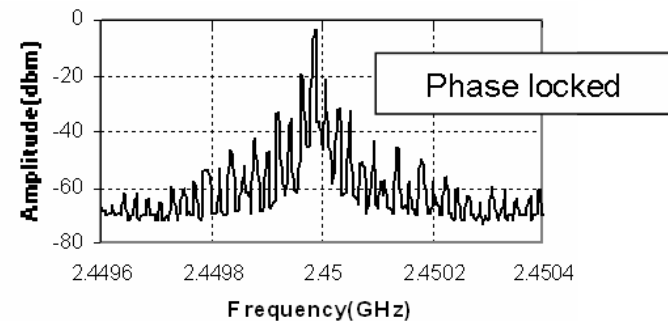
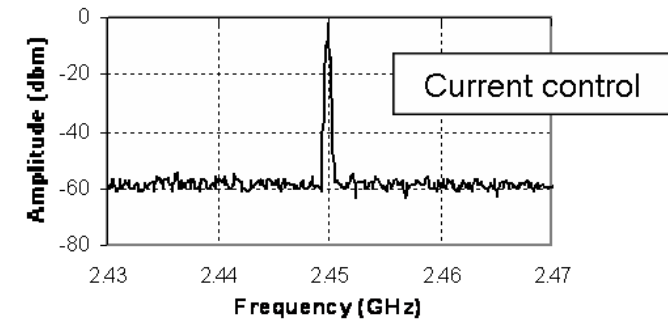
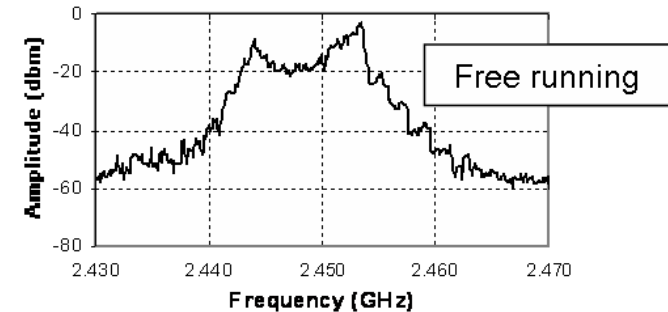

Magnetron for medical linacs

Frequency	2.855 GHz
RF Power	5.5 MW peak
Anode	51 kV; 240 A
Pulse	2.3 μ s
Duty	0.00055
Efficiency	45%

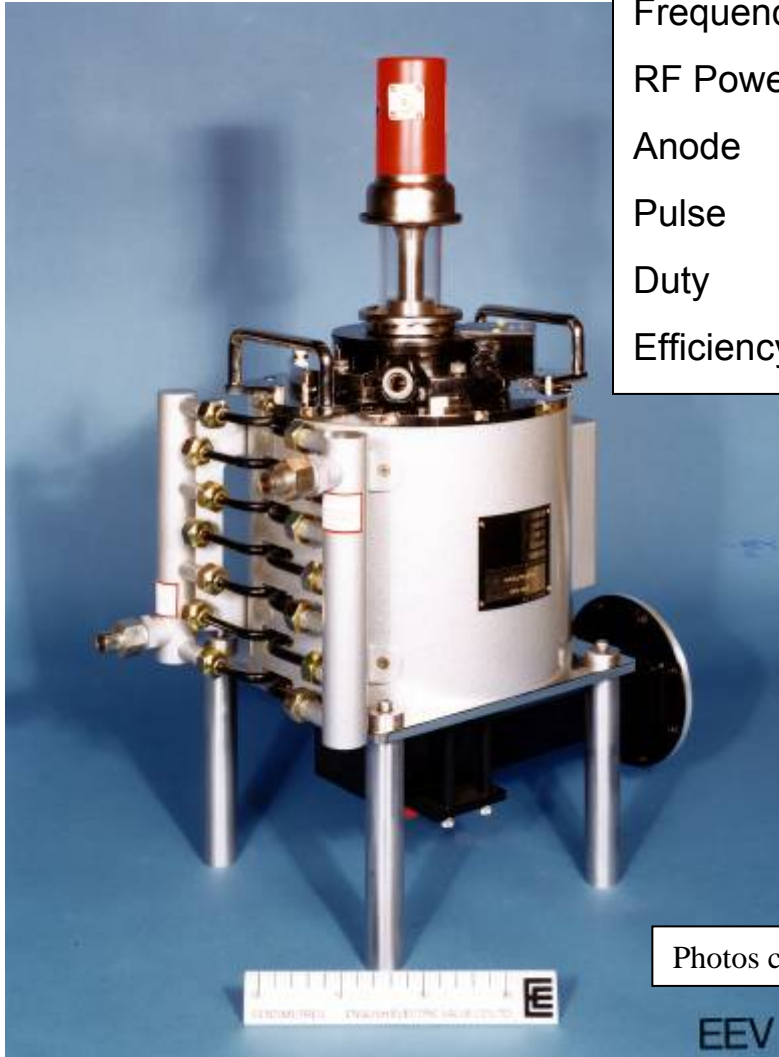

Photos courtesy of e2v technologies



Gyrotrons

- Interaction between a relativistic hollow electron beam and a waveguide TE mode
- Use of fast wave allows electrons to be further from the metal than in a klystron
- Cyclotron resonance requires strong axial magnetic field
- Chiefly developed for heating plasmas for fusion

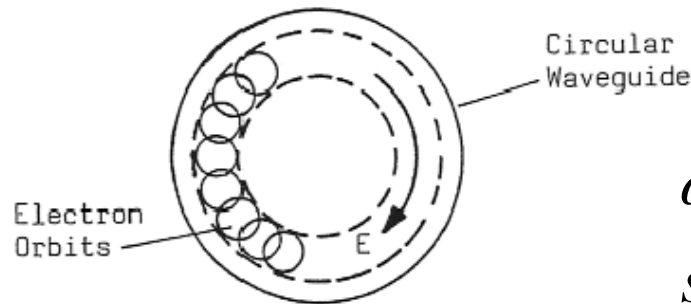
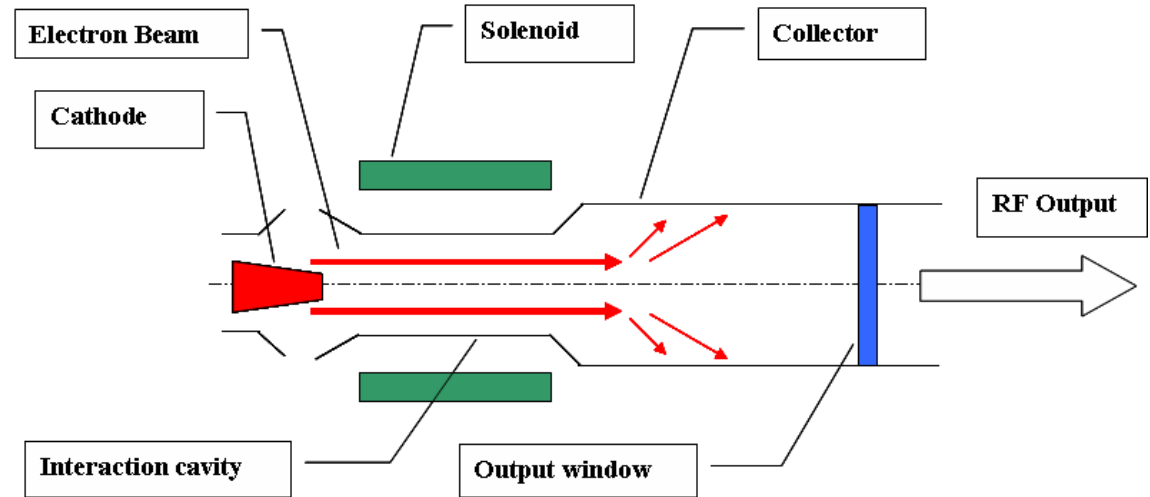

$$\omega = s \omega_c$$

$$s = 1, 2, 3 \dots$$

TH1506 Gyrotron Oscillator



Frequency	118 GHz
V_0	85 kV
I_0	22 A
Power	500 kW peak
Efficiency	30 %
Pulse	210 sec

Photo courtesy of Thales Electron Devices

Gyro-TWT Amplifier

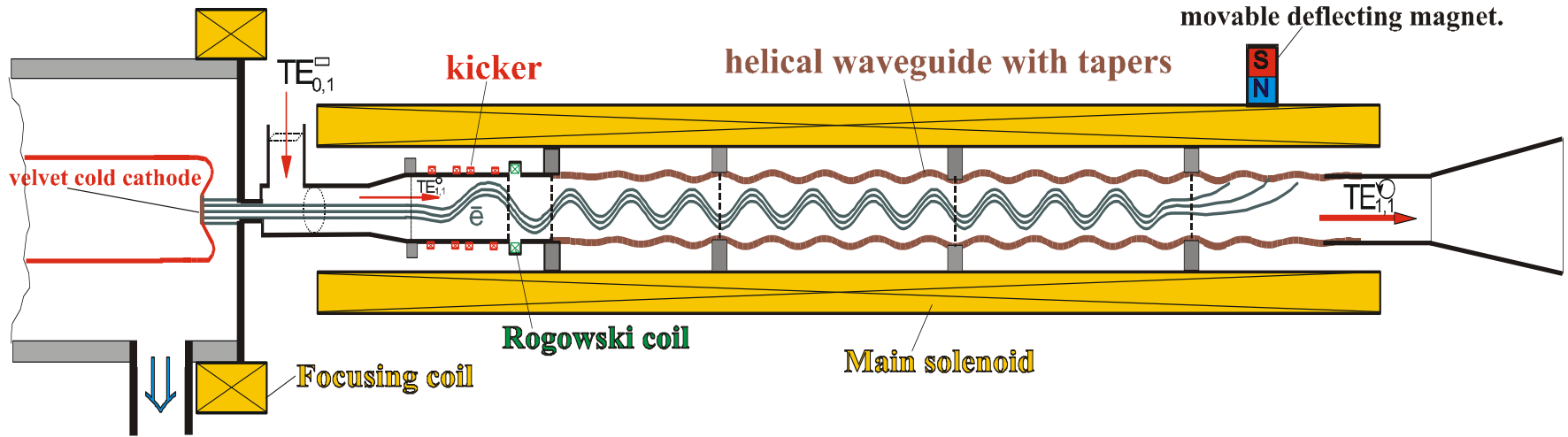

Output power (TE_{11})	1.1MW
Efficiency	29%
3 dB bandwidth at 9.4GHz	21%
Saturated gain	37dB
Small-signal gain	48dB

