



RF Deflecting Mode Cavities

Lecture I – Basics and Applications

Dr Graeme Burt

Lancaster University / Cockcroft
Institute

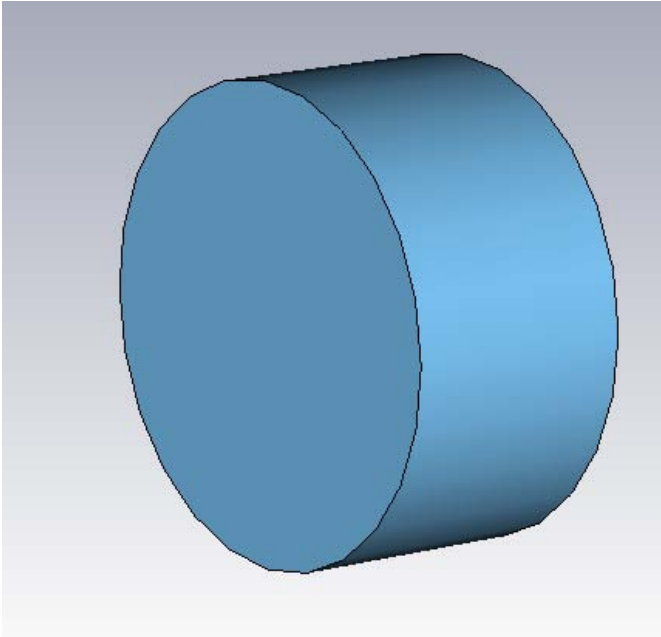
Pillbox Cavities



Wave equation in cylindrical co-ordinates

$$\left[\frac{1}{r} \frac{\partial}{\partial r} \left(r \frac{\partial}{\partial r} \right) + \frac{1}{r^2} \frac{\partial}{\partial \phi^2} + \mu \epsilon \omega^2 - k_z^2 \right] \psi = 0$$

Solution to the wave equation

$$\psi = A_1 J_m(k_t r) e^{\pm im\phi}$$

- Transverse Electric (TE) modes

$$H_z(r, \phi) = A_1 J_m \left(\frac{\zeta'_{m,n} r}{a} \right) e^{\pm im\phi} \quad H_t = \frac{ik_z a^2}{\zeta_{m,n}^2} \nabla_t H_z \quad E_t = -\frac{i\mu\omega a^2}{\zeta_{m,n}^2} (\hat{z} \times \nabla_t H_z)$$

- Transverse Magnetic (TM) modes

$$E_z(r, \phi) = A_1 J_m \left(\frac{\zeta_{m,n} r}{a} \right) e^{\pm im\phi} \quad E_t = \frac{ik_z a^2}{\zeta_{m,n}^2} \nabla_t E_z \quad H_t = \frac{i\epsilon\omega a^2}{\zeta_{m,n}^2} (\hat{z} \times \nabla_t E_z)$$

Bessel Function

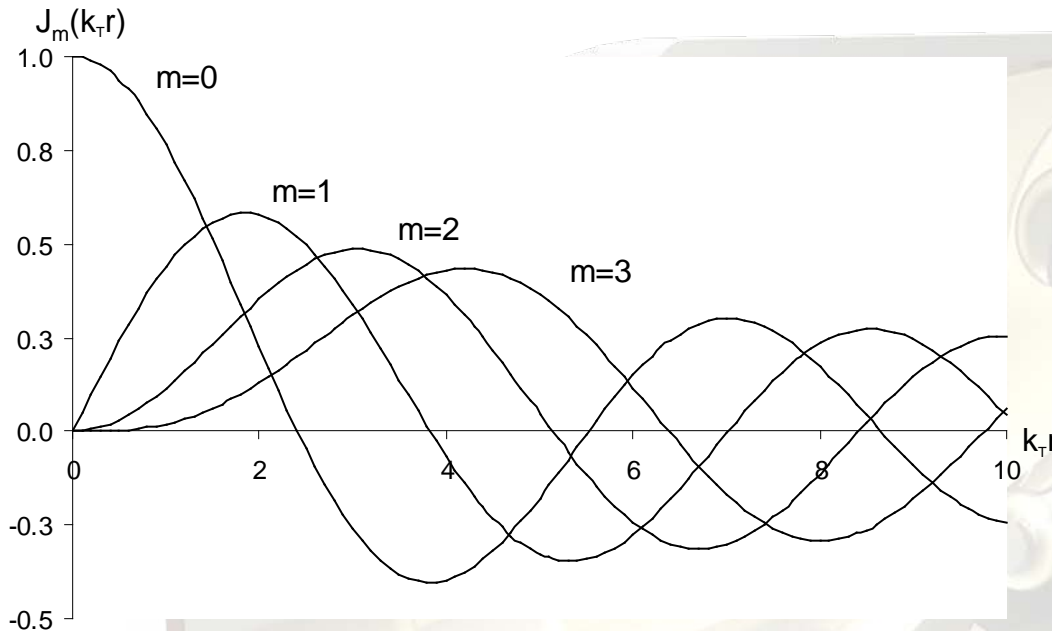

First four Bessel functions.

- E_z (TM) and H_z (TE) vary as Bessel functions in pill box cavities.
- All functions have zero at the centre except the 0th order Bessel functions.

One of the transverse fields varies with the differential of the Bessel function J'

All J' are zero in the centre except the 1st order Bessel functions

Transverse Kicks

- The force on an electron is given by

$$F = e(E + v \times B)$$

- If an electron is travelling in the z direction and we want to kick it in the x direction we can do so with either
 - An electric field directed in x
 - A magnetic field directed in y
- As we can only get transverse fields on axis with fields that vary with Differential Bessel functions of the 1st kind only modes of type TM_{1np} or TE_{1np} can kick electrons on axis.
- We call these modes dipole modes

TM₁₁₀ Dipole Mode

$$E_z = E_0 J_1(k_t r) \cos(\varphi)$$

$$H_z = 0$$

$$H_r = \frac{i\omega\epsilon}{k_t^2 r} E_0 J_1(k_t r) \sin(\varphi)$$

$$H_\varphi = \frac{-i\omega\epsilon}{k_t} E_0 J_1'(k_t r) \cos(\varphi)$$

$$E_\varphi = \frac{-ik_z}{k_t^2 r} E_0 J_1(k_t r) \sin(\varphi)$$

$$E_r = \frac{-ik_z}{k_t} E_0 J_1'(k_t r) \cos(\varphi)$$

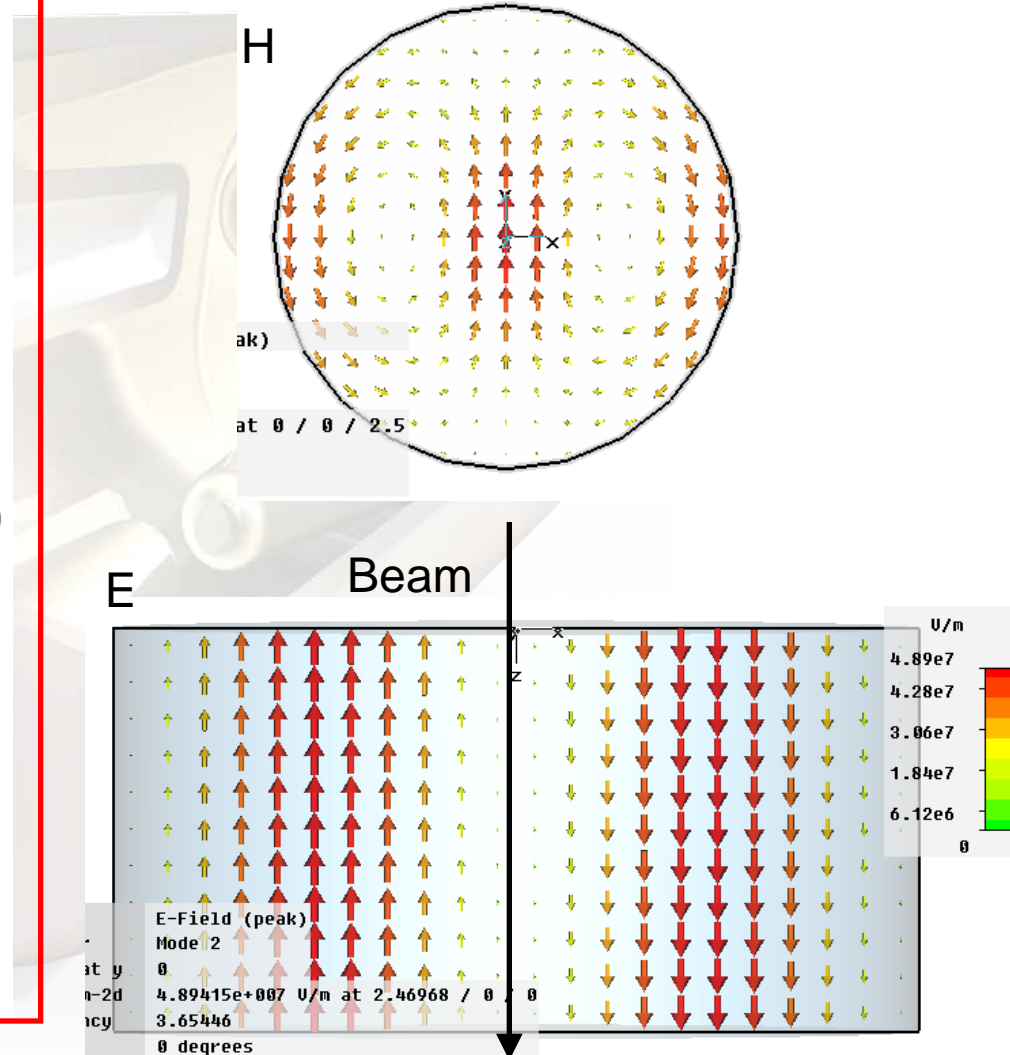

TE₁₁₁ Dipole Mode

$$H_z = H_0 J_1(k_t r) \sin(\varphi)$$

$$E_z = 0$$

$$H_r = \frac{-ik_z}{k_t} H_0 J_1'(k_t r) \sin(\varphi)$$

$$H_\varphi = \frac{-ik_z}{k_t^2 r} H_0 J_1(k_t r) \cos(\varphi)$$

$$E_\varphi = \frac{i\omega\mu}{k_t} H_0 J_1'(k_t r) \sin(\varphi)$$

$$E_r = \frac{-i\omega\mu}{k_t^2 r} H_0 J_1(k_t r) \cos(\varphi)$$

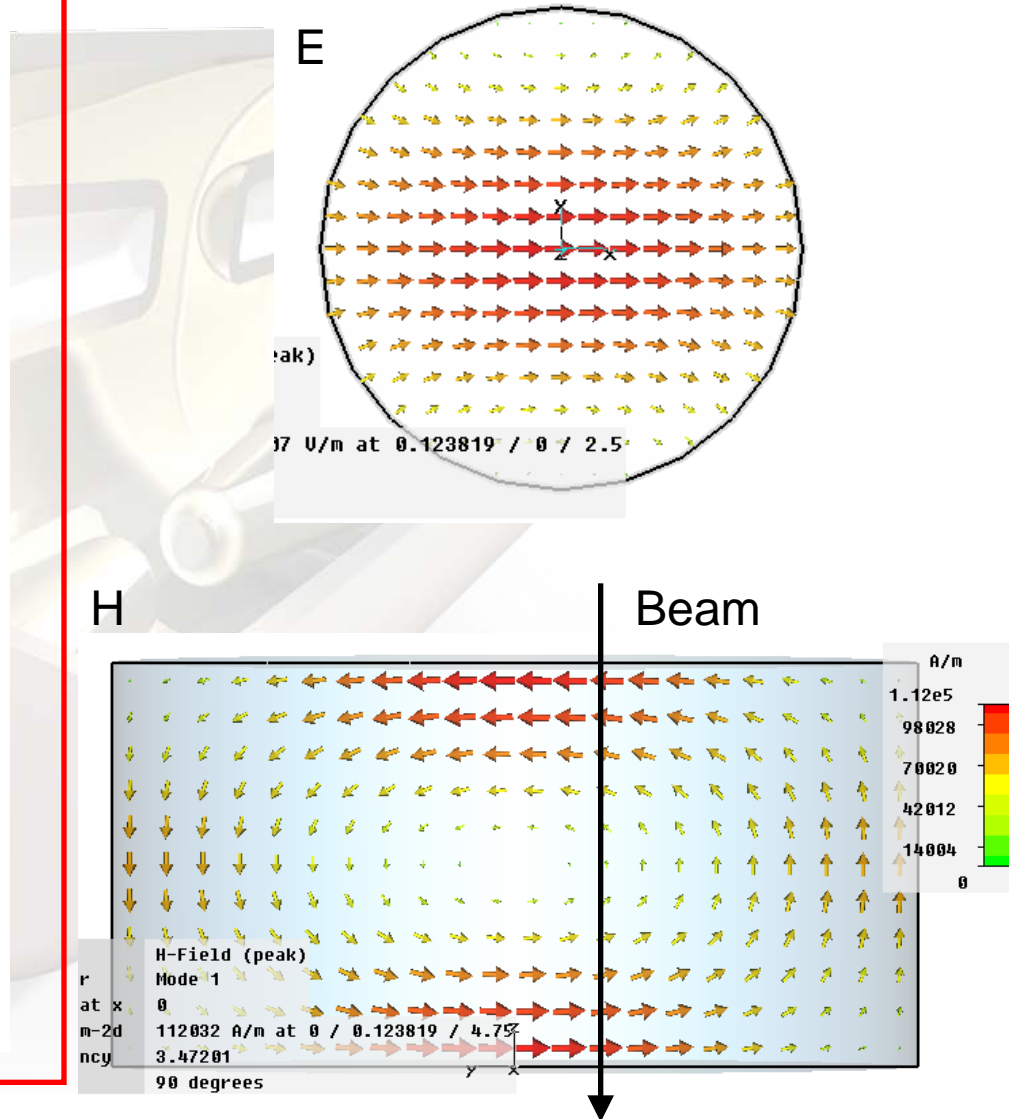

Panofsky-Wenzel Theorem

If we rearrange Faraday's Law ($\nabla \times E = -\frac{dB}{dt}$) and integrating along z we can show

$$c \int_0^L dz B(z, \tau = z/c) = c \int_0^L dz \int_{t_0}^{z/c} dt \left(\frac{\partial E_{\perp}(z, t)}{\partial z} - \nabla_{\perp} E_z(z, t) \right)$$

Inserting this into the Lorentz transverse force equation gives us

$$\int_0^L dz \left(E_{\perp}(z, z/c) + cB(z, z/c) \right) = c \int_0^L dz \int_{t_0}^{z/c} dt \left(\frac{dE_{\perp}(z, t)}{dz} - \nabla_{\perp} E_z(z, t) \right)$$

for a closed cavity where the 1st term on the RHS is zero at the limits of the integration due to the boundary conditions this can be shown to give

$$\int_0^L dz \left(E_{\perp}(z, z/c) + cB(z, z/c) \right) = -c \int_0^L dz \int_{t_0}^{z/c} dt \left(\nabla_{\perp} E_z(z, t) \right)$$

Panofsky-Wenzel Theorem

$$\int_0^L dz \left(E_{\perp} \left(z, z/c \right) + cB \left(z, z/c \right) \right) = -c \int_0^L dz \int_{t_0}^{z/c} dt \left(\nabla_{\perp} E_z \left(z, t \right) \right)$$

As the electrons have a large longitudinal energy we can approximate the kick from the magnetic field as equivalent to an electric field of magnitude $E=cB$. Hence we can define a transverse voltage

$$V_{\perp} = \int_0^L dz \left(E_{\perp} \left(z, z/c \right) + cB \left(z, z/c \right) \right)$$

$$V_{\perp} = -c \int_0^L dz \int_{t_0}^{z/c} dt \left(\nabla_{\perp} E_z \left(z, t \right) \right)$$

$$V_{\perp} = -\frac{ic}{\omega} \int_0^L dz \nabla_{\perp} E_z \left(z, z/c \right) \sim -\frac{ic}{\omega} \frac{mV_{\parallel}}{r^m}$$

This means the transverse voltage is given by the rate of change of the longitudinal voltage (for particles travelling close to c).

Transverse Shunt Impedance

For dipole modes, $m=1$, so the transverse voltage is given by

$$V_{\perp} = -\frac{ic}{\omega r} V_{\parallel}$$

For calculating required power we use a modified transverse shunt impedance definition

$$R_{\perp} = \frac{1}{2} \frac{|V_{\perp}|^2}{P_c}$$

We also use a modified transverse R/Q definition (like when calculating dipole wakefields) except this definition is in the units of Ohms and is in a more convenient form for calculating power and energy requirements for deflecting cavities.

$$\frac{R}{Q} = \frac{|V_{\perp}|^2}{2\omega U} = \frac{|V_{\parallel}(r)|^2}{2\omega U} \left(\frac{c}{\omega r} \right)^2$$

TE modes

- The transverse kick is proportional to the rate of radial change in the E_z field.
- TE modes do not have longitudinal electric fields so they cannot kick an electron beam.

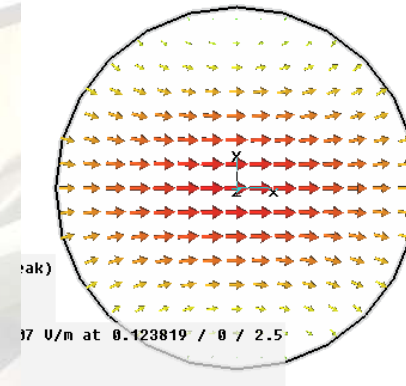
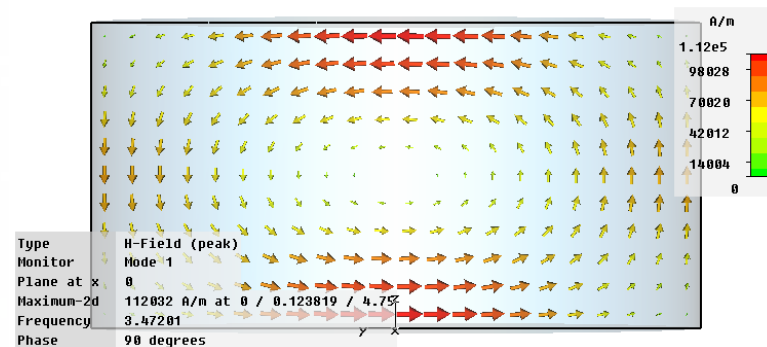

- But the TE₁₁₀ mode has transverse E and B fields what happens to their kick?
- The transverse kick due to the electric fields and the magnetic fields completely cancel each other out
- Note: for low beta cavities TE modes can be used for deflecting

Beam-Pipes

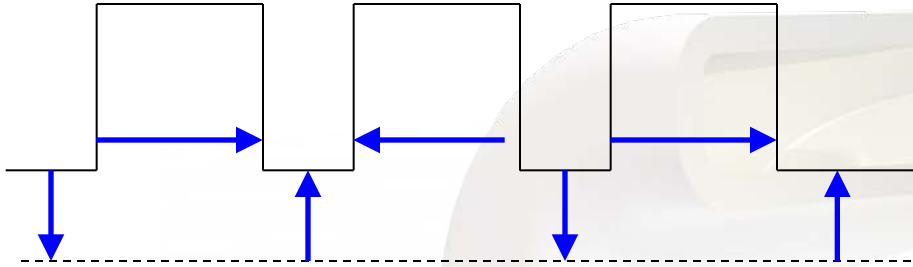

When we add the beam-pipes the TM₁₁₀ mode in the cavity couples to the TE₁₁ mode of the beam-pipe.

- The fields near the centre of the cavity becomes

$$E_x = \mathcal{E} \frac{k}{4} (a^2 + x^2 - y^2) \sin kz \cos \omega t,$$

$$E_y = \mathcal{E} \frac{k}{2} xy \sin kz \cos \omega t,$$

$$E_z = \mathcal{E} x \cos kz \cos \omega t,$$

$$cB_x = \mathcal{E} \frac{k}{2} xy \cos kz \sin \omega t,$$

$$cB_y = -\mathcal{E} \frac{1}{k} \left(\frac{(ka)^2}{4} - 1 + \frac{k^2(x^2 - y^2)}{4} \right) \cos kz \sin \omega t,$$

$$cB_z = -\mathcal{E} y \sin kz \sin \omega t.$$

Fields seen on-axis

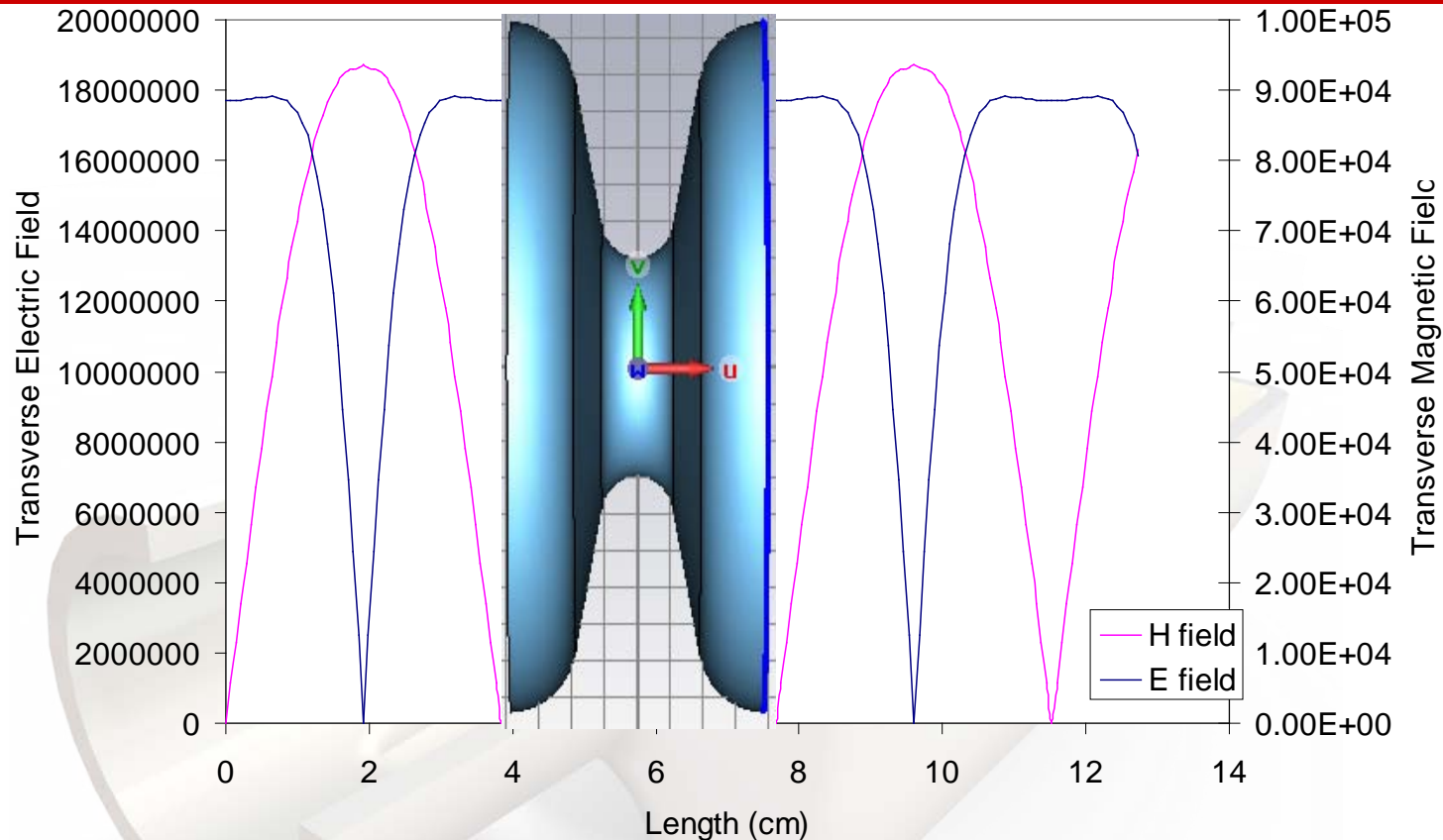

The electric and magnetic fields are 90 degrees out of phase in both space and time so that their kicks coherently add.

The electric field is in the iris and the magnetic field is in the cavity

Single-cell crab cavity

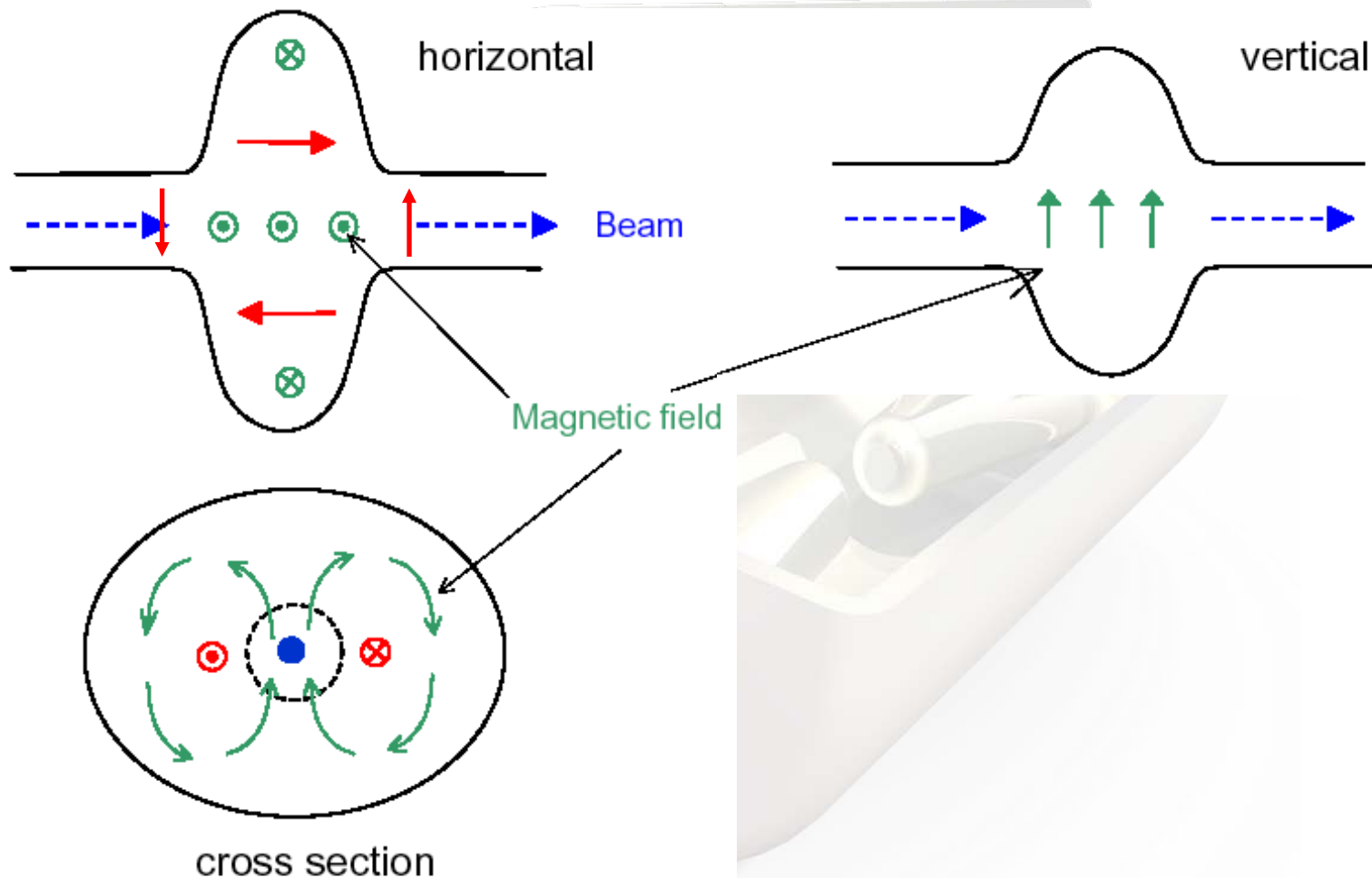

Applications of Deflecting Cavities

- Particle separation
- Temporal beam diagnostics
- Crab-crossing in colliders
- X-ray pulse compression
- Emittance exchange
- Choppers are very similar but will not be discussed here!

Transverse Kick

- If we apply a kick of voltage V_t to a charged particle it gain a transverse energy qV_t
- If the electron has a longitudinal energy E_0 then the electron will have a trajectory with angle,

$$- x' = \arctan(qV_t/E_0) \sim qV_t/E_0$$

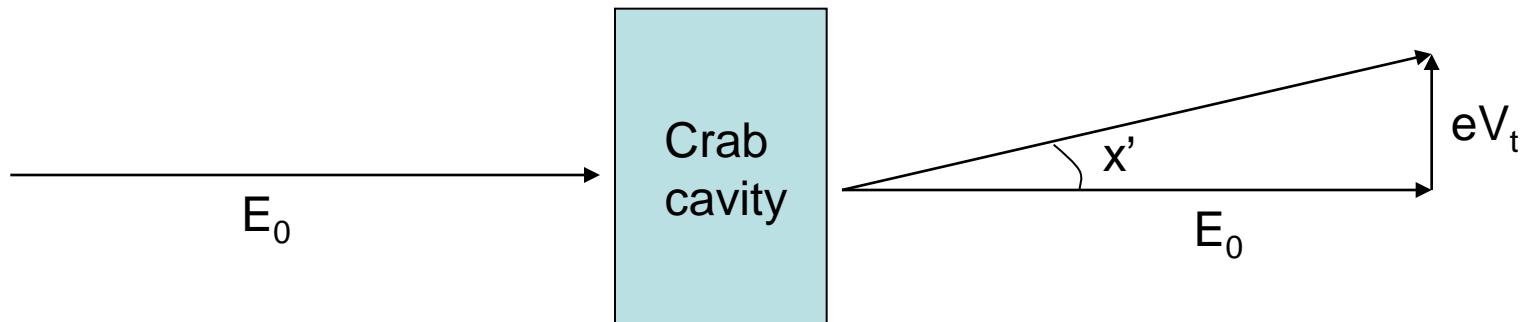

- The transfer matrix element R_{12} relates the final offset x to the initial angle x' hence

$$- x = R_{12} qV_t/E_0$$

Kick or rotation

As the transverse kick varies sinusoidally in time, the finite bunch width means that each part of the bunch receives a different kick.

If the centre of the bunch is synchronised to pass through the cavity at the zero crossing, the head and tail of the bunch will receive equal and opposite kicks. Causing the bunch to appear to rotate as it travels towards its destination.

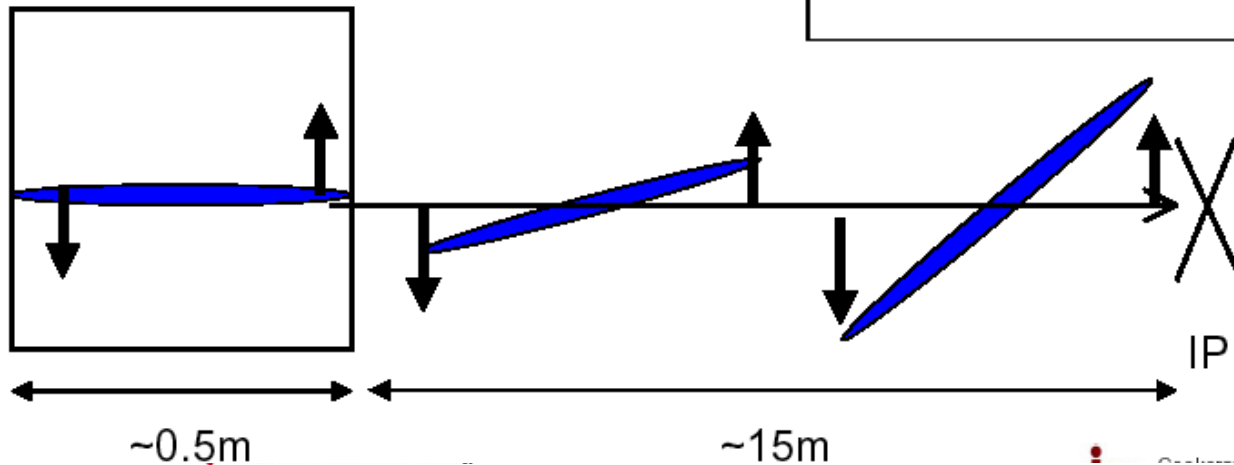
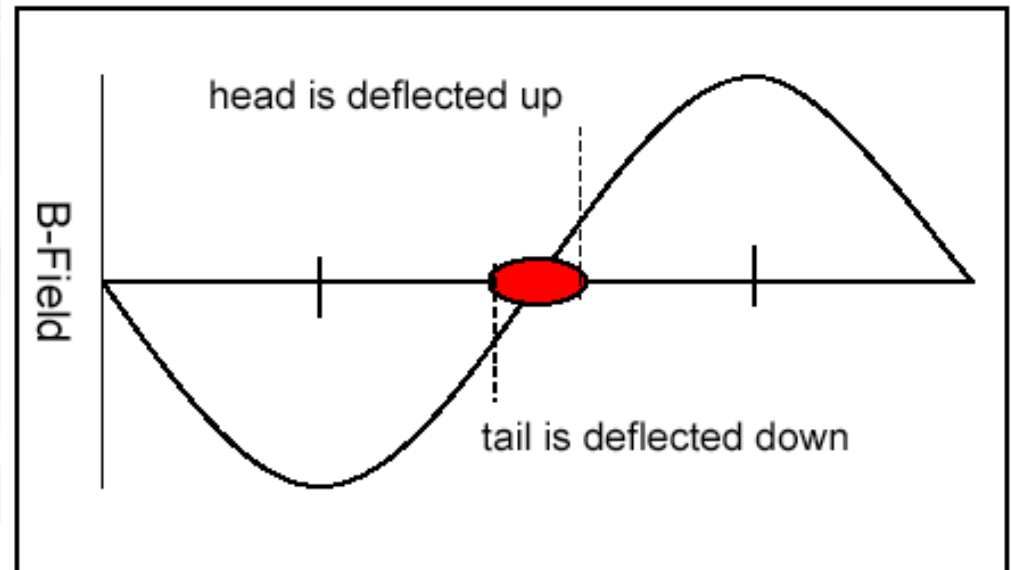

If a cavity is in rotating phase we call it a crab cavity

Particle Separators

- The earliest use of transverse deflecting cavities were particle separators. There are two different schemes for its use.
 - Can separate different bunches to send them to different experiments
 - Can separate out different particle species in a bunch

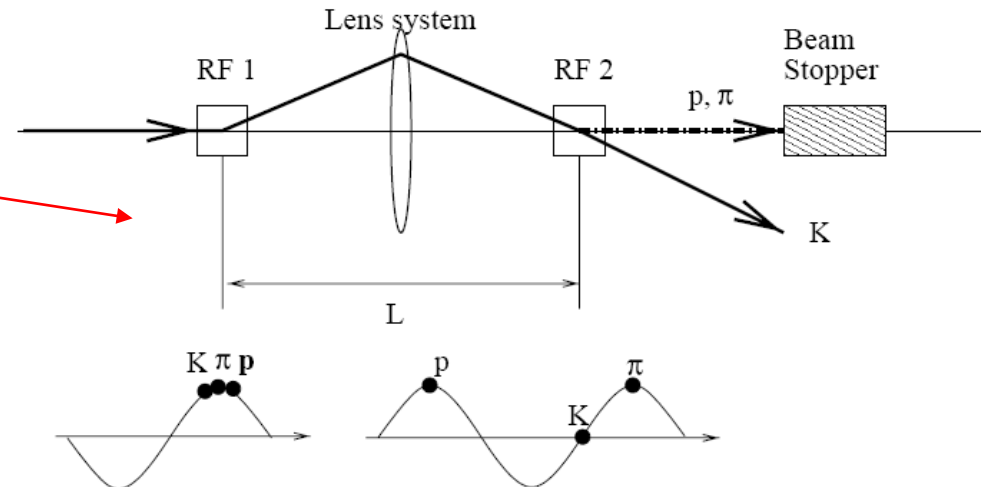
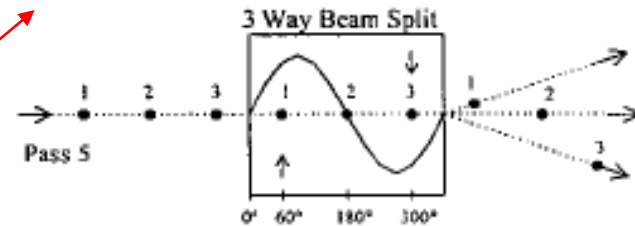
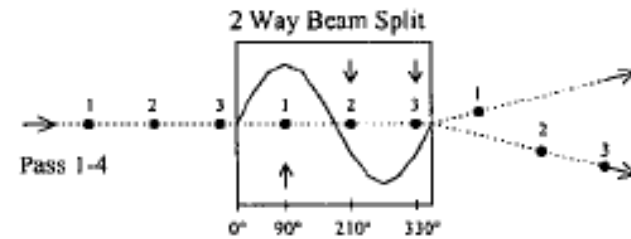

$$\Delta\phi = \omega \frac{L}{c} \left(\frac{1}{\beta_K} - \frac{1}{\beta_\pi} \right)$$

Deflecting Cavity for Longitudinal Phase space diagnostics

If we kick the bunch at the zero phase such that the bunch is rotated we can calculate the bunch length by measuring the offset. The resolution is dependant on the bunch width and the transverse voltage

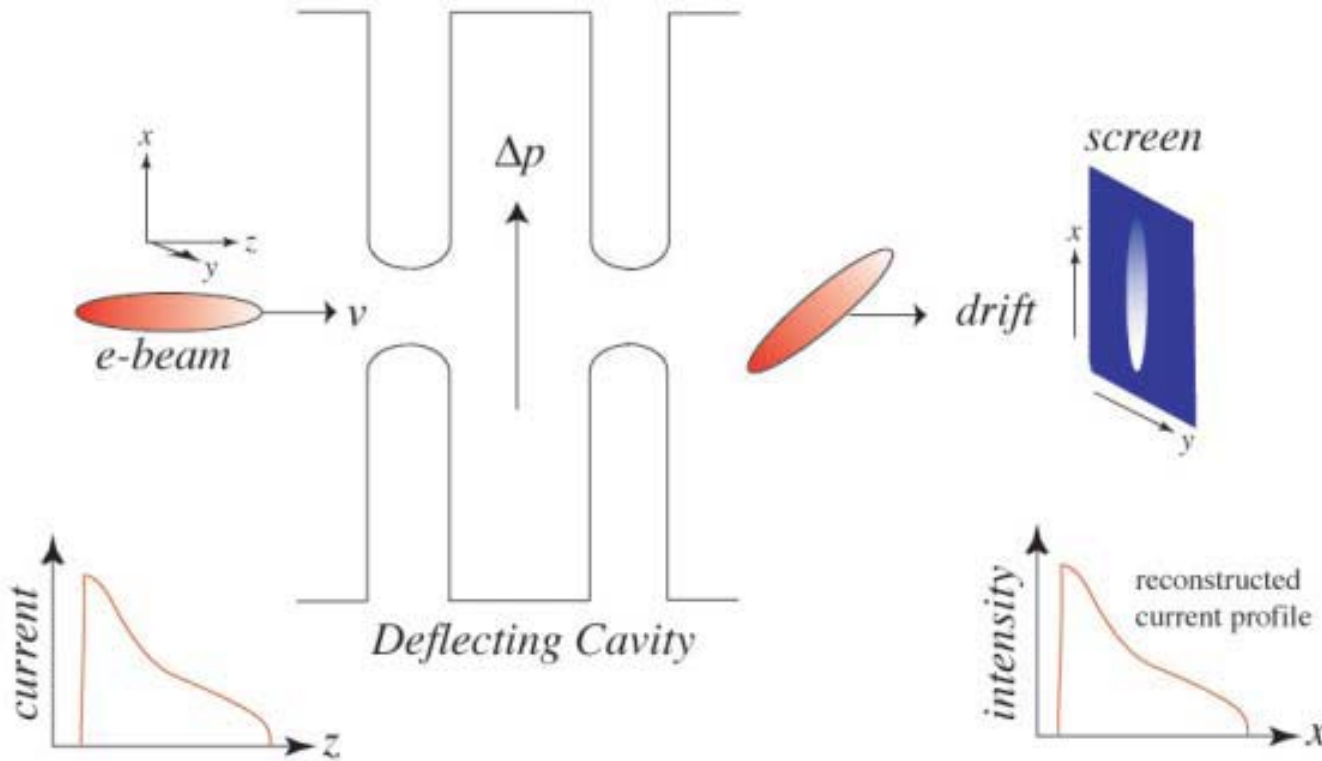

$$x = R_{12} \frac{V_{\perp} \sin(\omega \Delta t)}{E_0}$$

$$\frac{x E_0}{V_{\perp} R_{12}} = \sin\left(\omega \frac{\sigma_z}{c}\right)$$

$$\sigma_z \approx \frac{c x E_0}{\omega V_{\perp} R_{12}}$$

X-ray Pulse Compression

- Use transverse-deflecting rf cavities to impose a correlation (“chirp”) between the longitudinal position of a particle within the bunch and the vertical momentum.
- The second cavity is placed at a vertical betatron phase advance of $n\pi$ downstream of the first cavity, so as to cancel the chirp.
- With an undulator or bending magnet placed between the cavities, the emitted photons will have a strong correlation among time and vertical slope.
- This can be used for either pulse slicing or pulse compression.

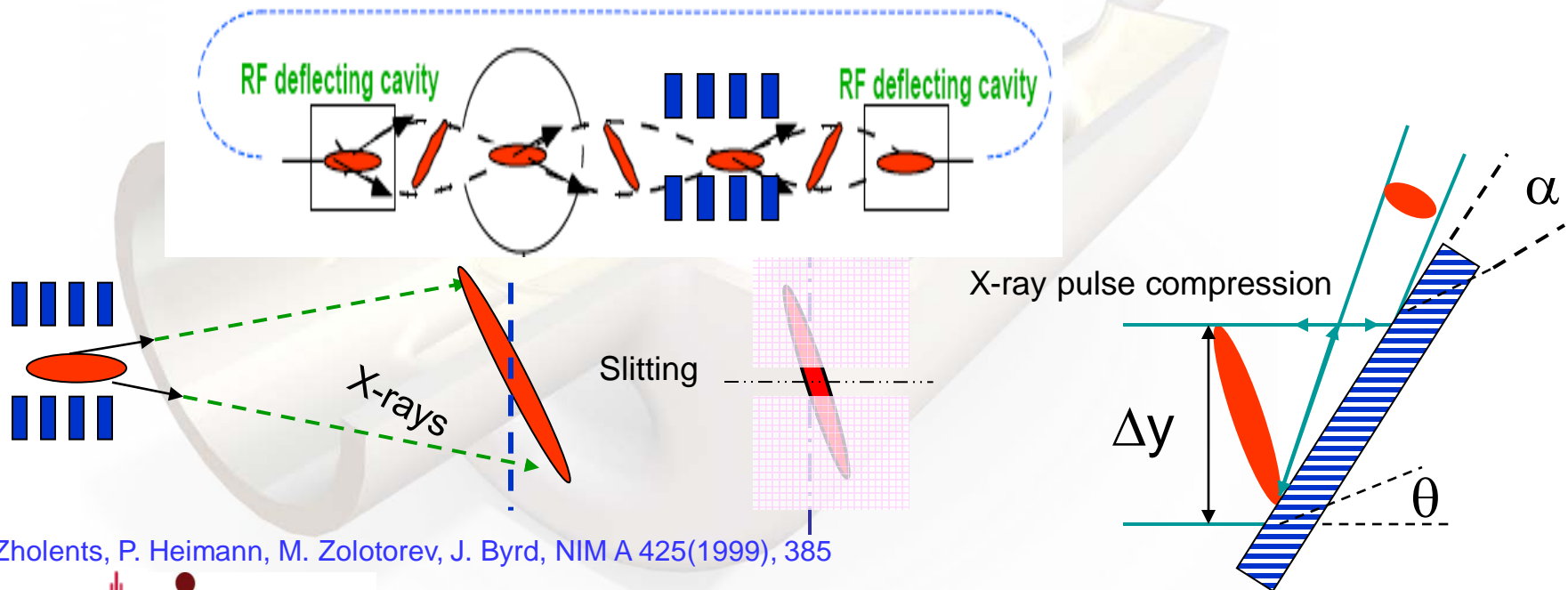

A. Zholents, P. Heimann, M. Zolotarev, J. Byrd, NIM A 425(1999), 385

Frequency Choice in Crab Cavities

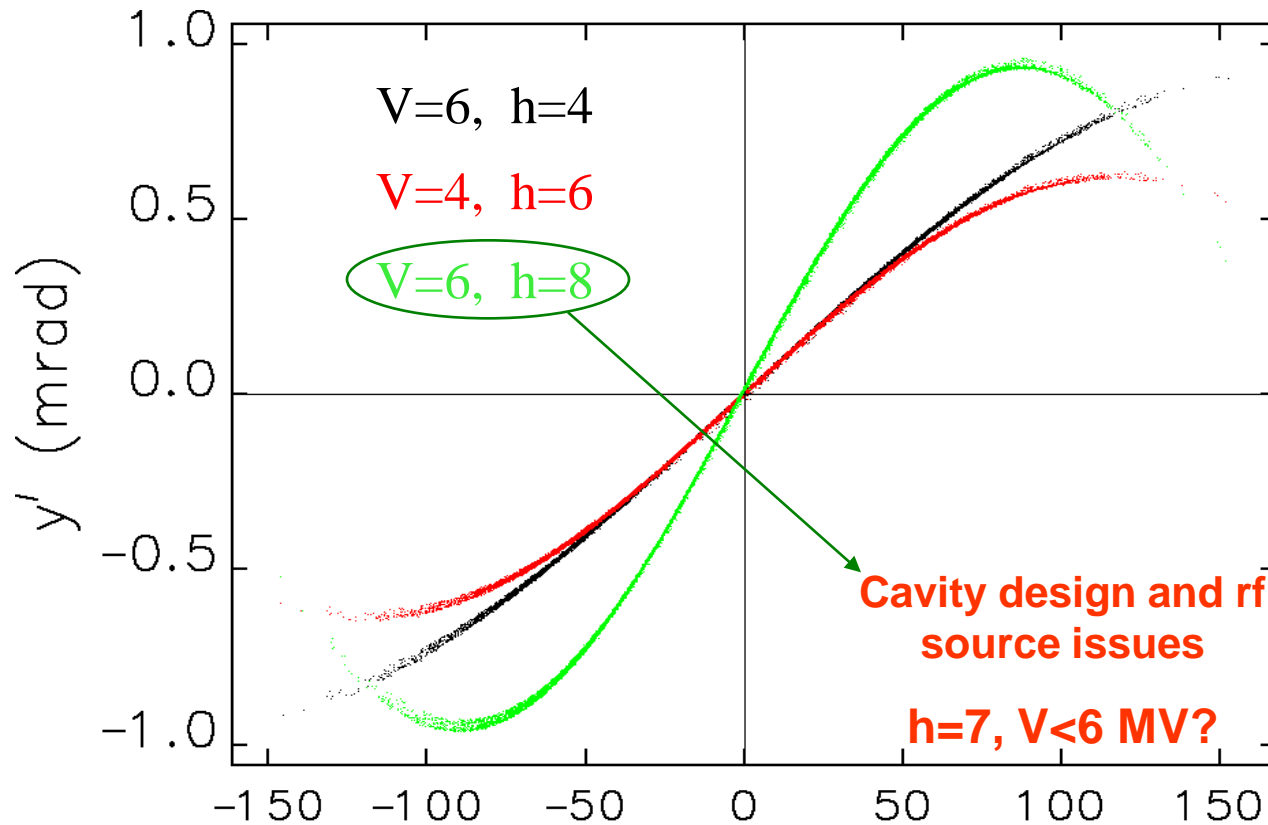

Can get the same compression as long as $h \cdot V$ is constant

Higher V and lower h : more linear chirp and less need for slits

Higher h and lower V : smaller maximum deflection and less lifetime impact

Higher h and maximum V : shortest pulse, acceptable lifetime

Beam dynamics simulation study:
 $h \geq 4$ (1.4 GHz)
 $V \leq 6 \text{ MV}$ (lifetime)

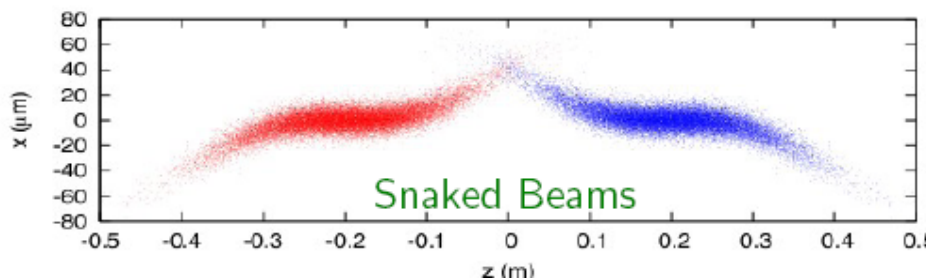

Emittance Exchange

- TM110 dipole cavities also have a longitudinal electric field which is zero on axis and varies linearly with transverse offset.

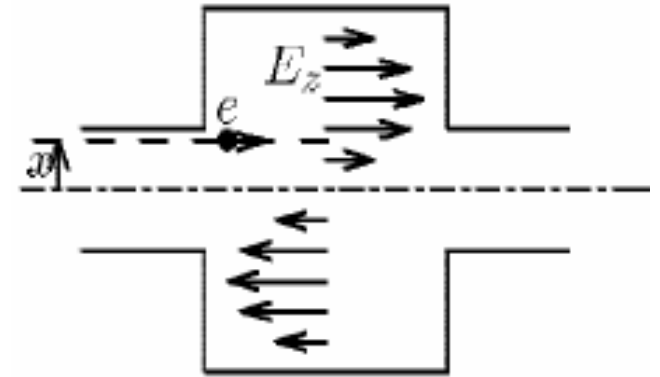
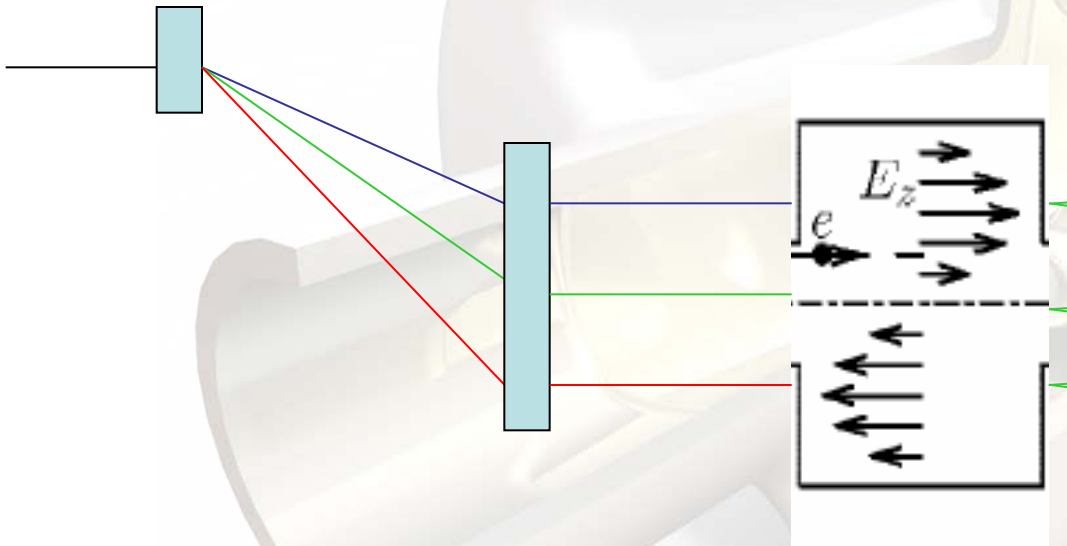

If we pass a beam through some dipole magnets the beam will spread out dependant on the bunch energy

We then pass the beam through a dipole cavity and accelerate /decelerate electrons based on transverse position reducing longitudinal emittance.

The beam will however get some transverse spread due to the transverse fields hence the longitudinal and transverse emittance is exchanged.

Emittance Exchange

Dog-Leg for generating dispersion

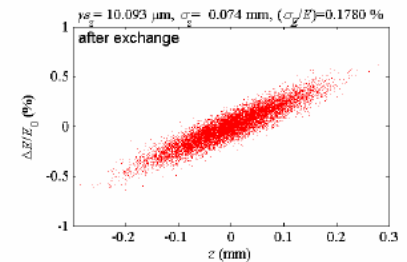
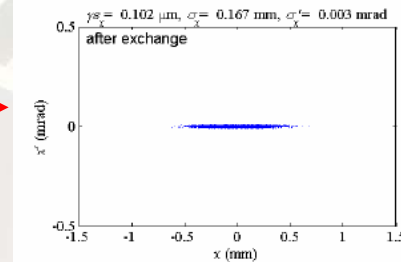
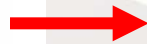
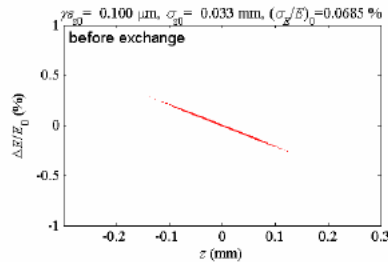
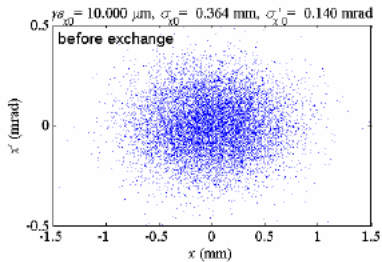
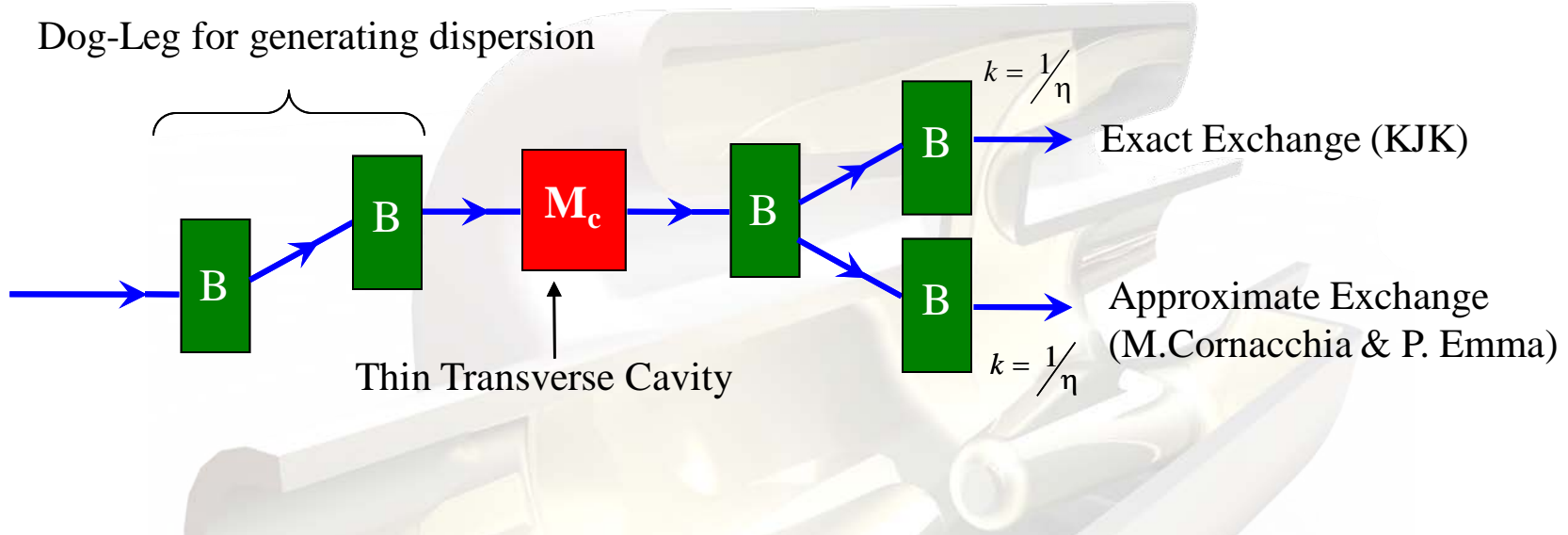

Crab Cavities for Colliders

Head-on collision

Maximum luminosity

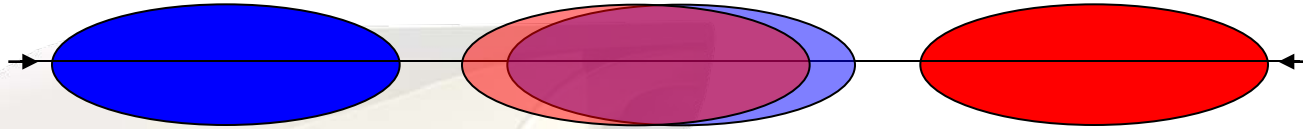

Crossing angle introduced

Reduced luminosity due to crossing angle

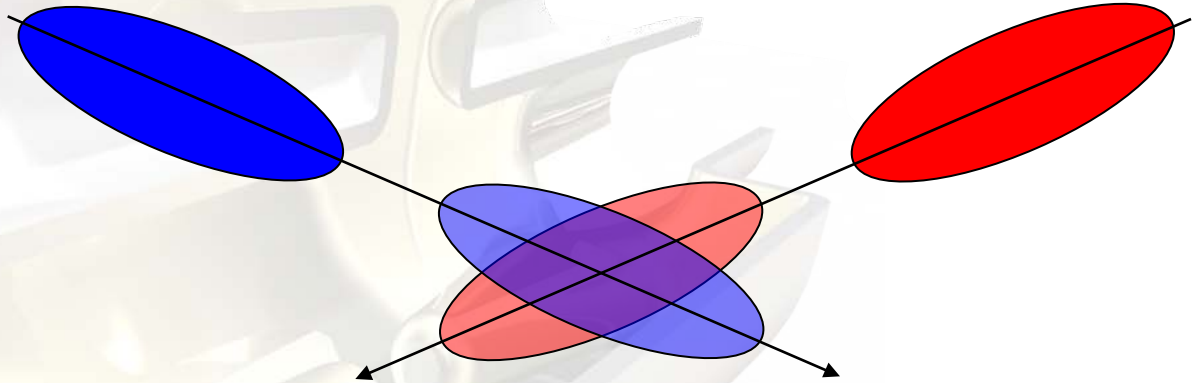

Crossing angle with crab rotation

Effective head-on collision

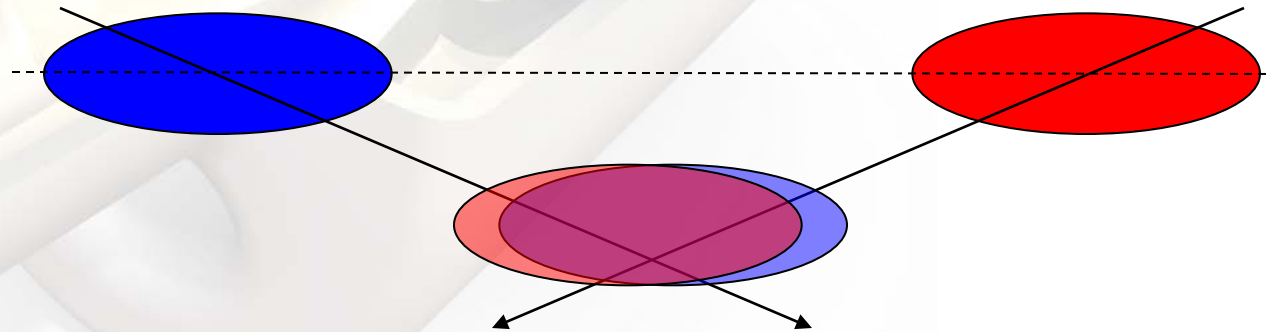

X-Angle Reduction Factor: $\frac{L}{L_0} \approx \left[1 + \left(\frac{\sigma_x}{\sigma_z} \tan(\theta_c/2) \right)^2 \right]^{-1/2}$

Crab Cavities in Circular Machines

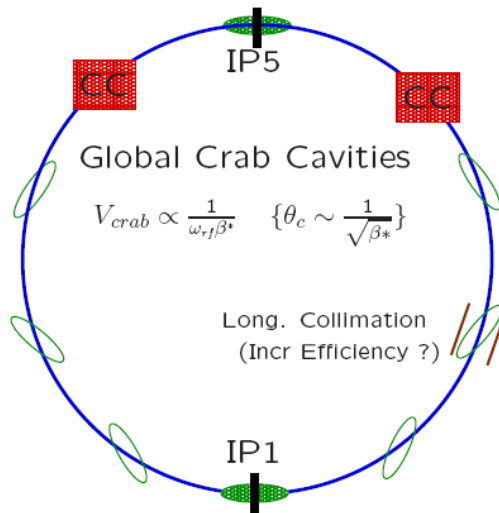

- For circular machines the bunches obviously pass through the crab cavity multiple times.
- If we use a single crab cavity the beam will oscillate about the ring which may cause problems for collimation.
- This is known as a global scheme and is utilised at KEKB.

- If collimation is problematic for a global scheme we can use two crab cavities both placed at a phase advance of $\pi/2$ from the IP on either side.
- One cavity crabs the beam and the other un-crabs it such that it doesn't oscillate about the ring.

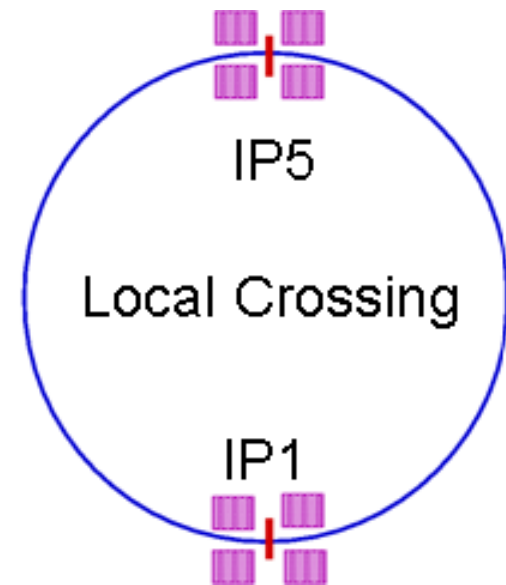

Effect of distance between crab cavity and focusing quadrupole

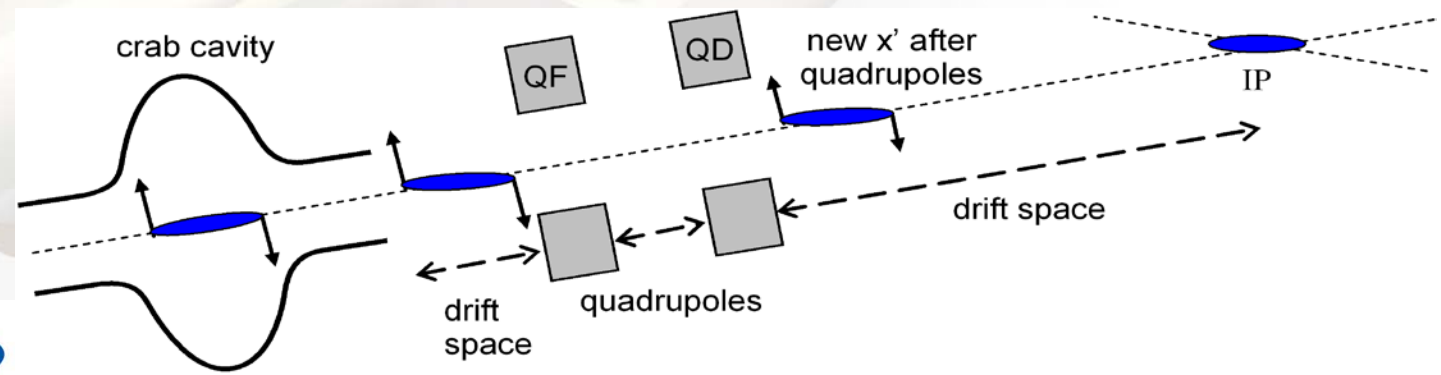
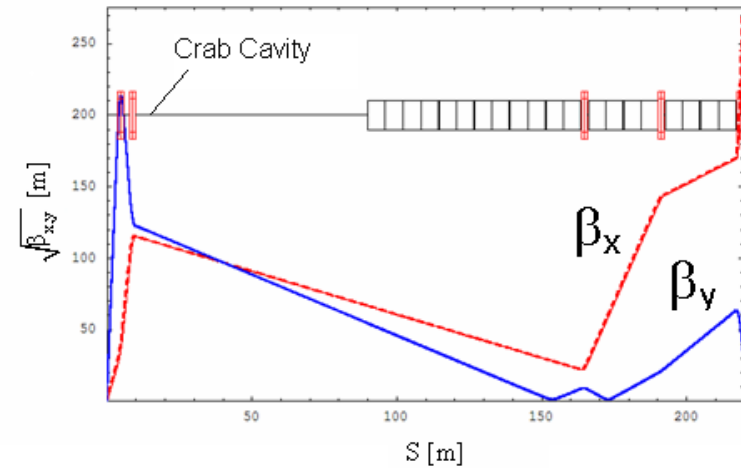
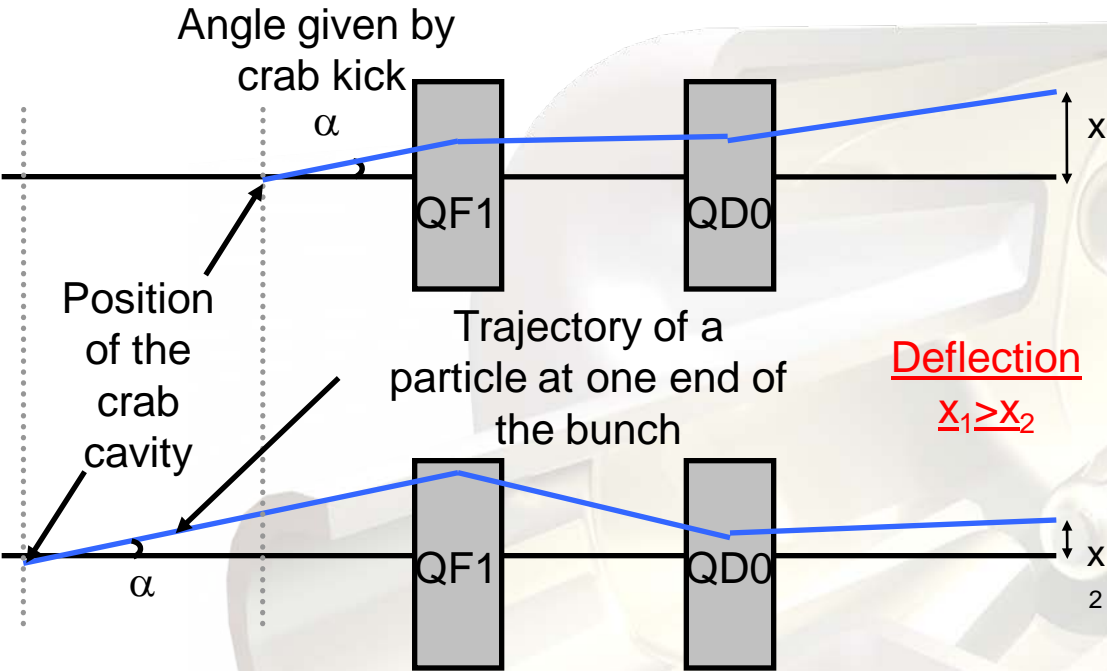

Voltage Stability

For optimum cell length

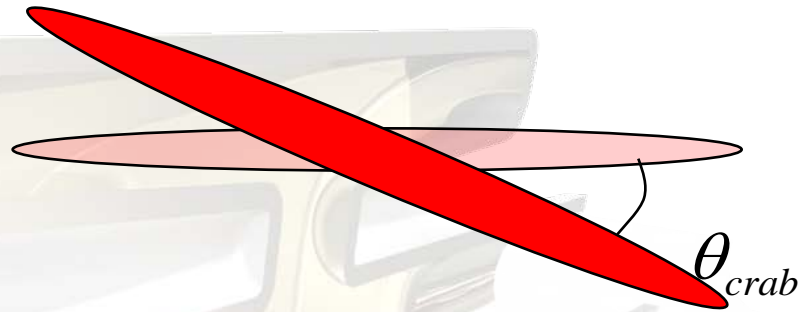

θ_{crab} is proportional to the maximum magnetic field in the cavity

voltage error induces errors in bunch rotation

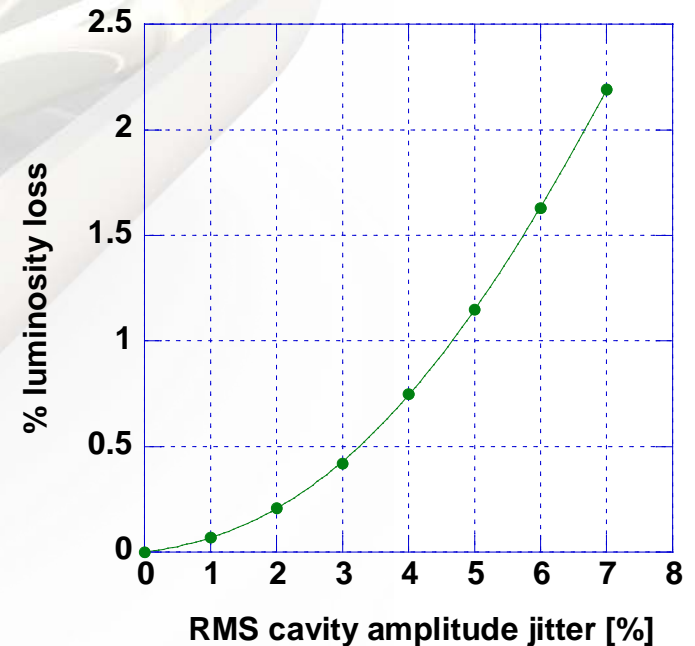
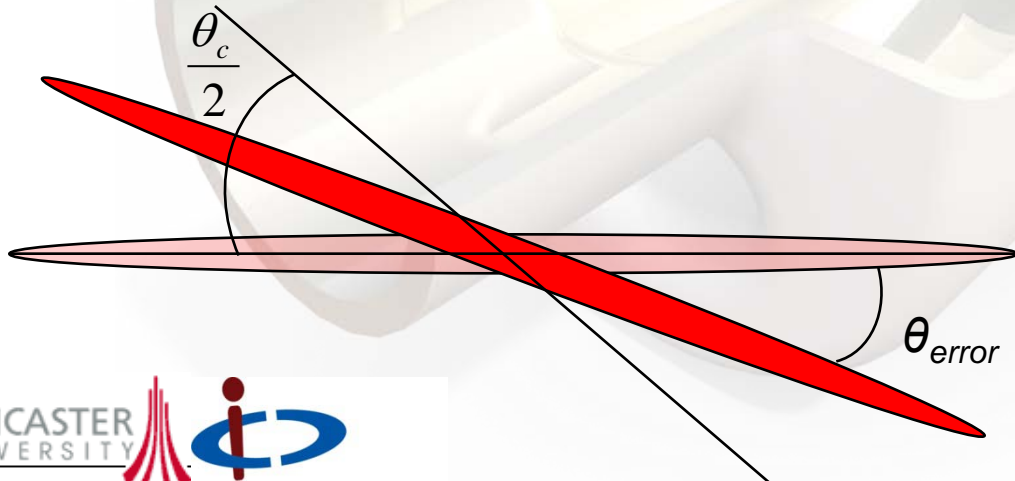

Absolute cavity phase error

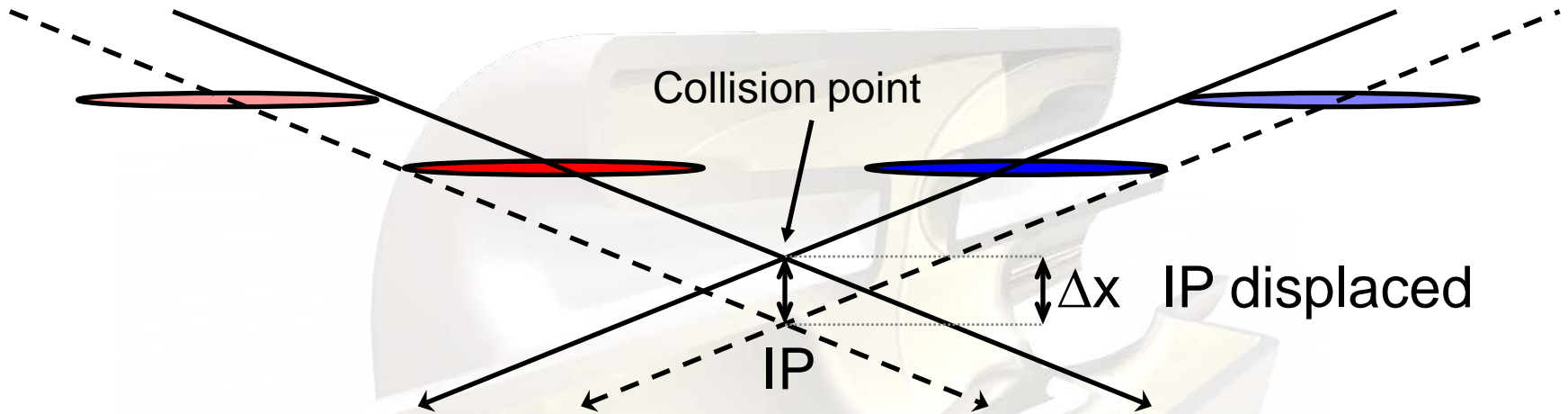

Phase error (deg) for 2%
luminosity loss

for cavity frequency

Crossing angle	<i>for cavity frequency</i>	
	1.3GHz	3.9GHz
10mrad	6	19
20mrad	3	9

Absolute cavity
phase error is not a
major concern

Crab cavity phase tolerances

Relative phase tolerance between the crab cavities on electron and positron side of the IP is critical as it will cause an x-offset between the beams.

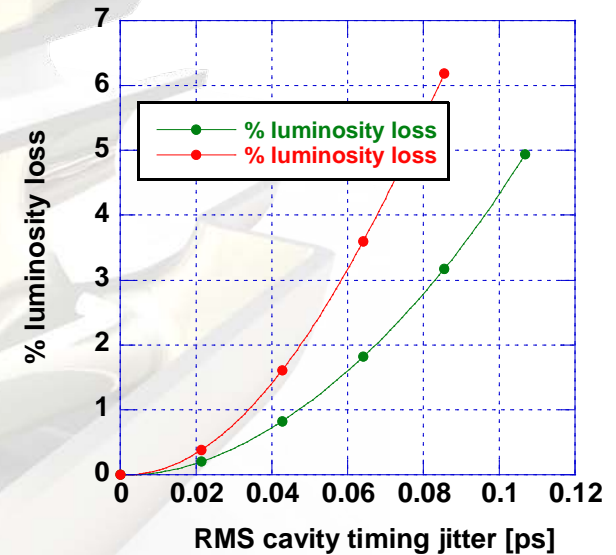
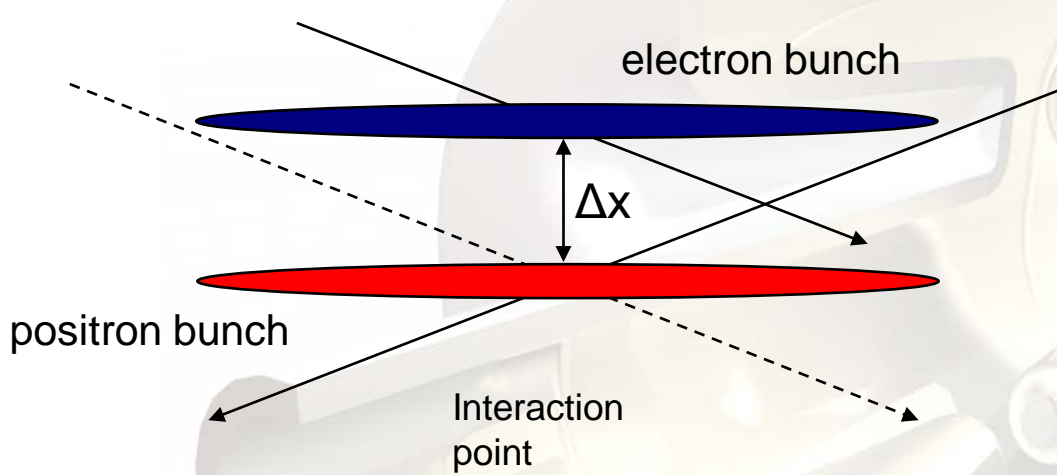

Typically set for <2% luminosity loss ($S=0.98$)

For ILC nominal parameters $\sigma_x=639\text{nm}$,
 $\Delta x=181\text{nm}$, $\Delta t=86\text{ fsec}$

ILC phase tolerance $\sim 80\text{ fsec}$, state of the art.

Luminosity reduction factor

$$S = e^{\left(-\frac{\Delta x^2}{4\sigma_x^2}\right)}$$

The allowed timing error

$$\Delta t \approx \frac{2\Delta x}{\theta_c c}$$

Bunch arrival time Jitter

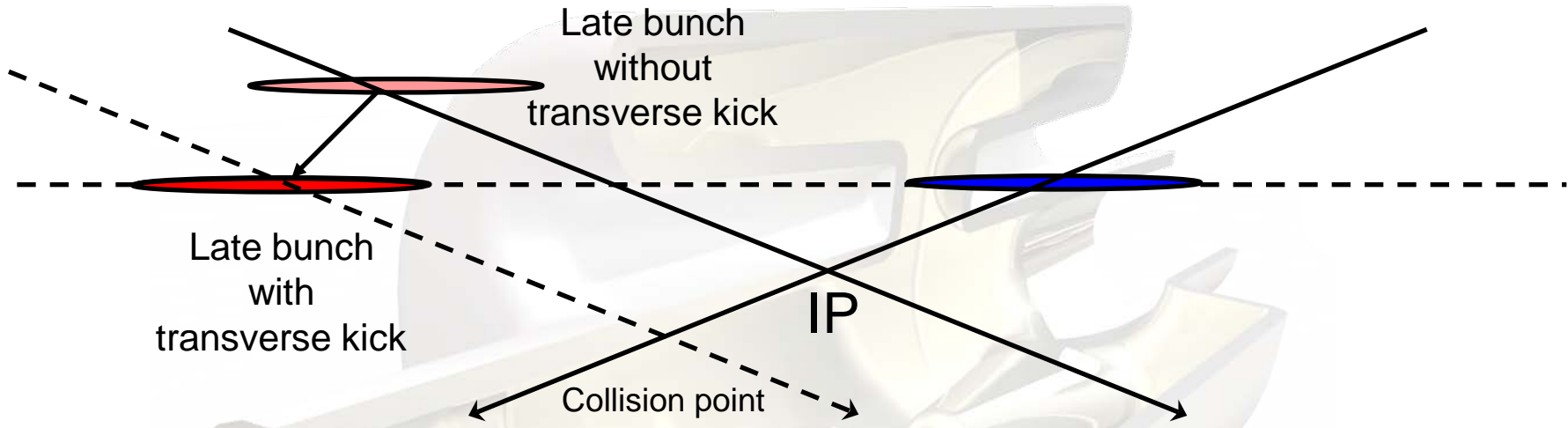

It is found that the crab cavity can correct for variation in bunch arrival time by providing a total transverse kick to early or late bunches, such that both bunch collide head-on.

