

An introduction to collective effects

Giovanni Rumolo

in CERN Accelerator School, Chavannes de Bogis

Friday, 8 November, 2013

Thanks to S. Aumon, H. Bartosik, P. Chiggiato, A. Findlay, S. Gilardoni, W. Herr, A. Hofmann, G. Iadarola, E. Koukovini-Platia, K. Li, B. Mikulec, N. Mounet, A. Oeftiger, G. Papotti, F. Roncarolo, B. Salvant, E. Shaposhnikova, H. Timkó, R. Tomás, R. Wasef, C. Zannini

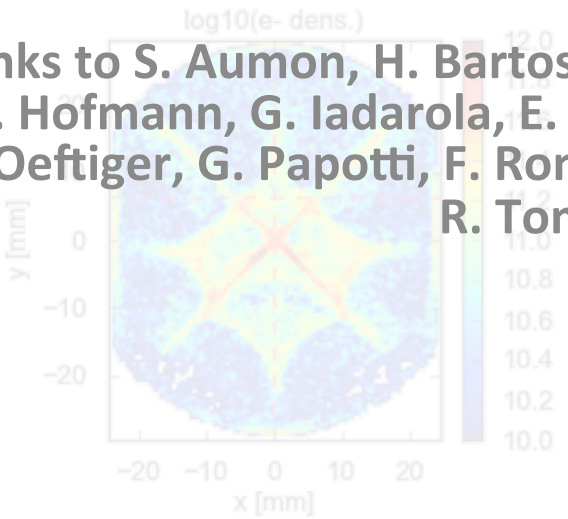

The CERN Accelerator School

What are the collective effects?

- A general definition of collective effects
 - Class of phenomena in beam dynamics, in which the evolution of a particle in a beam depends on both the external EM fields and the extra EM fields created by the presence of other particles.
- How other particles can affect a single particle's motion:
 - **Self-induced EM fields**
 - Space charge from beam particles
 - EM interaction of whole beam with surrounding environment
 - EM interaction of whole beam with its own synchrotron radiation
 - **Coulomb collisions**
 - Long range and multiple two beam particle encounters → Intra-beam scattering
 - Short range and single events two beam particle encounters → Touschek effect
 - Elastic and inelastic scattering against residual gas
 - **EM fields from another charge distribution** (generated or not by the beam itself), like a second “beam”
 - Beam-beam in colliders
 - Ion trapping for electron beams
 - Electron clouds for positron/hadron beams
 - Interactions with electron lens or electron cooling system

Types of collective effects

- Collective effects start playing a role when the beam density is very high
 - They are also referred to as “high current”, “high intensity”, “high brightness” effects and exhibit a threshold behaviour
 - They result into a measurable response of the beam to the collective interaction, which can be **detrimental and lead to beam degradation and loss**
- **Transverse coherent collective effects**
 - Due to self-induced EM fields
 - The beam centroid is affected, resulting in betatron tune shift and possibly in exponential growth (single or multi-bunch instabilities, strong head-tail)
 - Can be seen with standard BPMs

Transverse coherent instability

An example

- Occurrence of a transverse coherent instability
 - The beam centroid, as detected by a BPM, exhibits an exponential growth typically on the time scale of tens to thousands of turns, usually associated with beam loss and/or emittance growth!

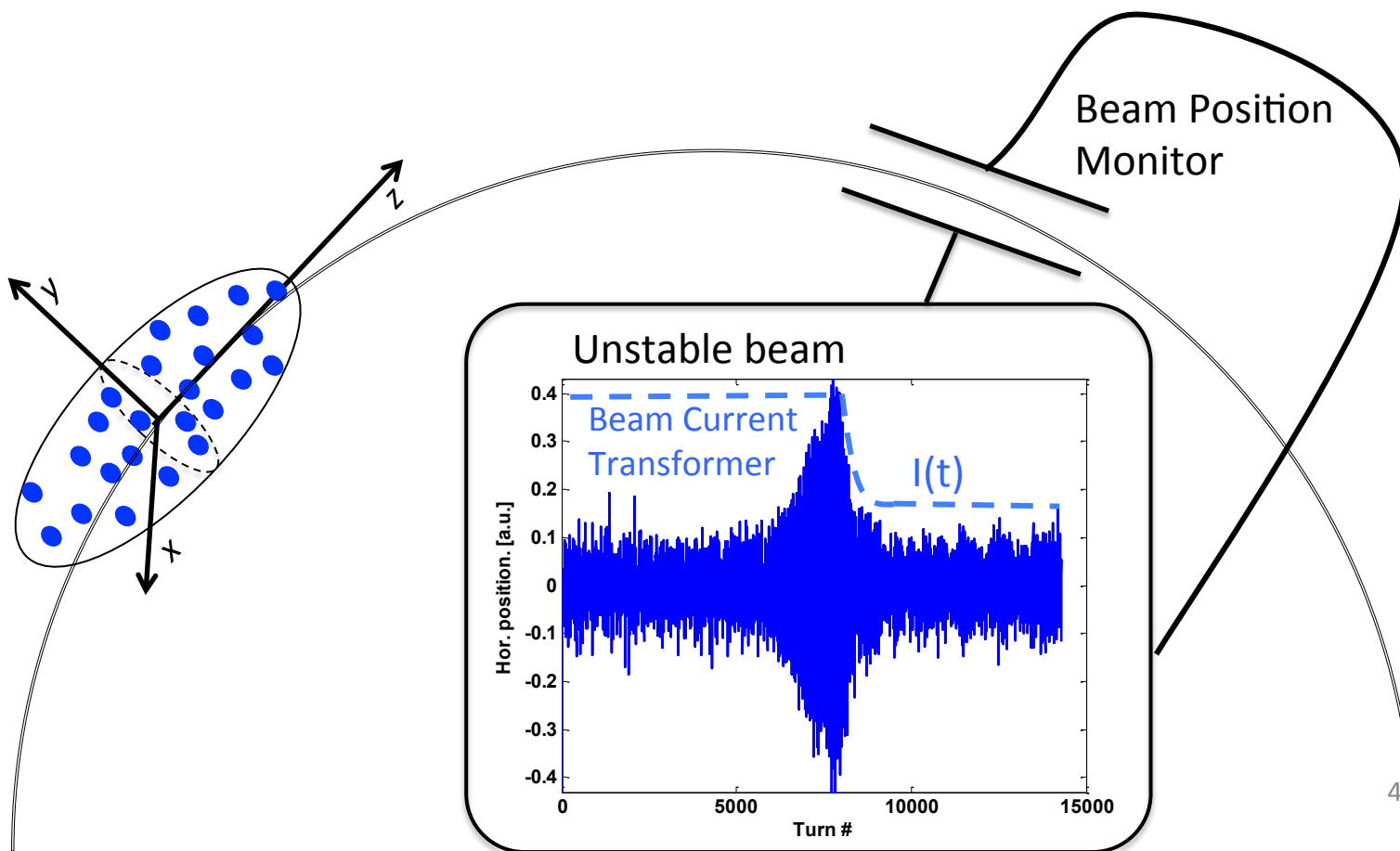

Types of collective effects

- Collective effects start playing a role when the beam density is very high
 - They are also referred to as “high current”, “high intensity”, “high brightness” effects and exhibit a threshold behaviour
 - They result into a measurable response of the beam to the collective interaction, which can be **detrimental and lead to beam degradation and loss**
- **Transverse coherent collective effects**
 - Due to self-induced EM fields
 - The beam centroid is affected, resulting in betatron tune shift and possibly in exponential growth (single or multi-bunch instabilities, strong head-tail)
 - Can be seen with standard BPMs
- **Transverse incoherent collective effects**
 - Due to self-induced EM fields (and their interaction with machine optics)
 - The strength of the excitation is not such as to build up into a coherent effect, i.e. the beam centroid is not affected
 - Typically leading to slow losses and emittance growth, diffusion, halo and tail formation

Transverse incoherent effect

An example

- Transverse incoherent effect
 - A beam exhibits slow losses (on the time scale of the cycle or store) and emittance growth visible from a beam profile measurement device, possibly associated to development of halo or tails

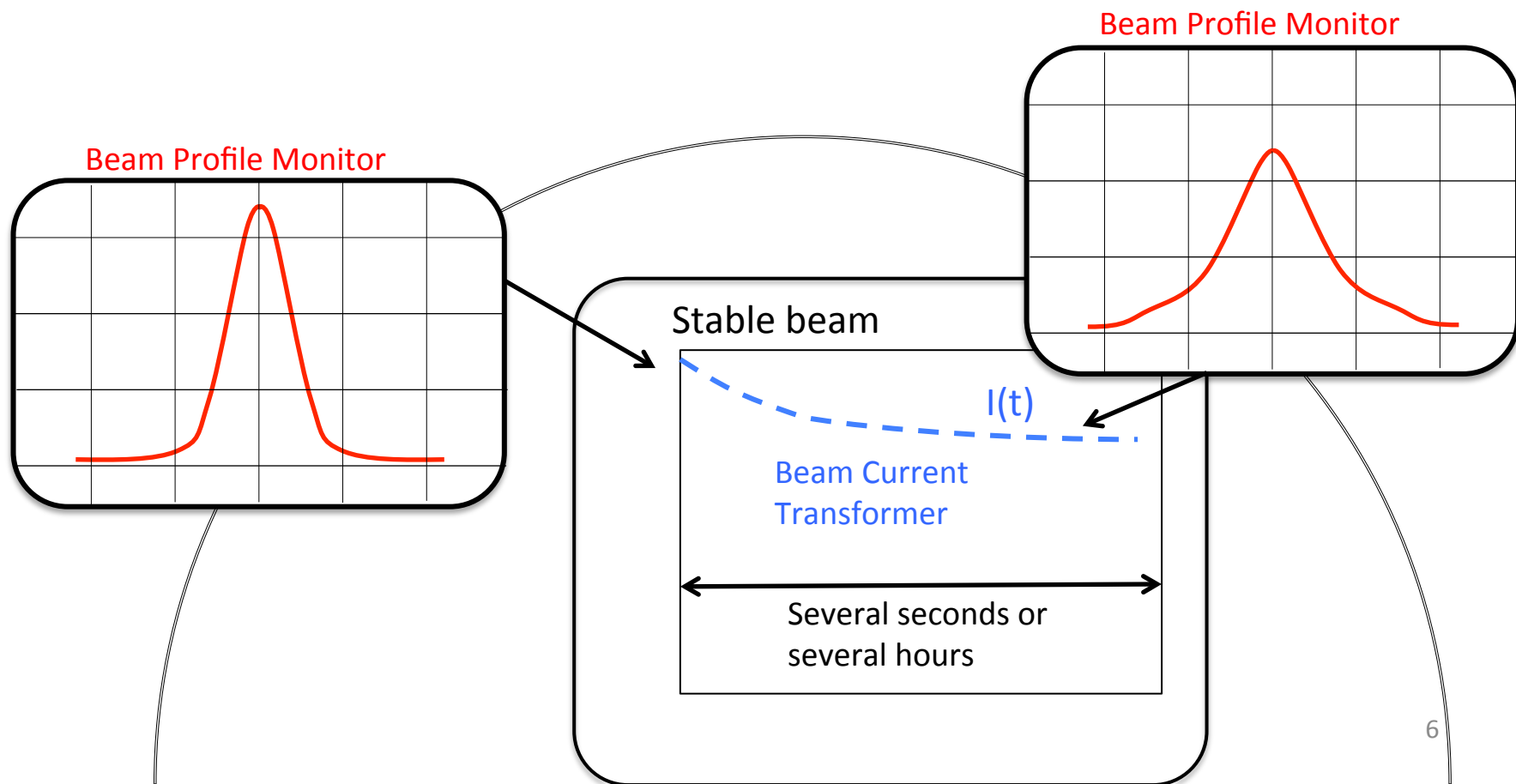

Types of collective effects

- Collective effects start playing a role when the beam density is very high
 - They are also referred to as “high current”, “high intensity”, “high brightness” effects and exhibit a threshold behaviour
 - They result into a measurable response of the beam to the collective interaction, which can be **detrimental and lead to beam degradation and loss**
- **Longitudinal collective effects**
 - Due to self-induced EM fields
 - Energy loss, potential well distortion (synchronous phase shift, bunch lengthening)
 - Instabilities (single or coupled bunch instabilities, microwave instability)

Longitudinal coherent modes

An example

- Longitudinal coherent modes
 - The beam profile, measured at a Wall Current Monitor, shows bunches oscillating in their buckets (plot 2) or executing quadrupole oscillations (plot 3)

Observations in the CERN SPS in 2007

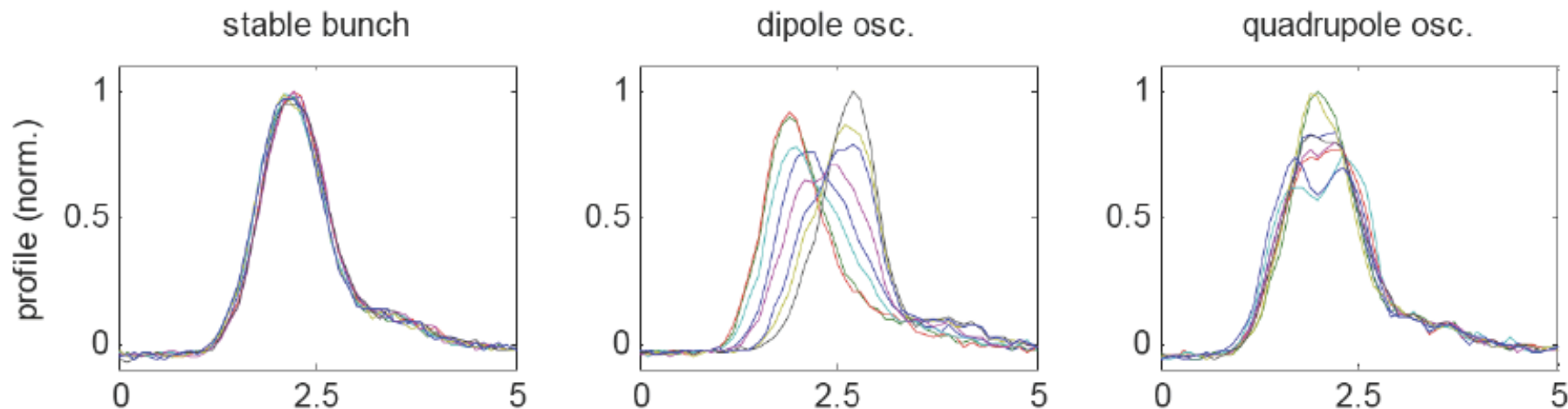

Longitudinal microwave instability

An example

- Debunching long bunch in the SPS during Machine Development
 - For impedance identification purpose, a long bunch is injected into the SPS with the RF off.
 - A microwave instability develops on the beam as it debunches
 - From the Fourier analysis of the resulting micro-bunching it is possible to reconstruct the most important frequency components of the longitudinal impedance

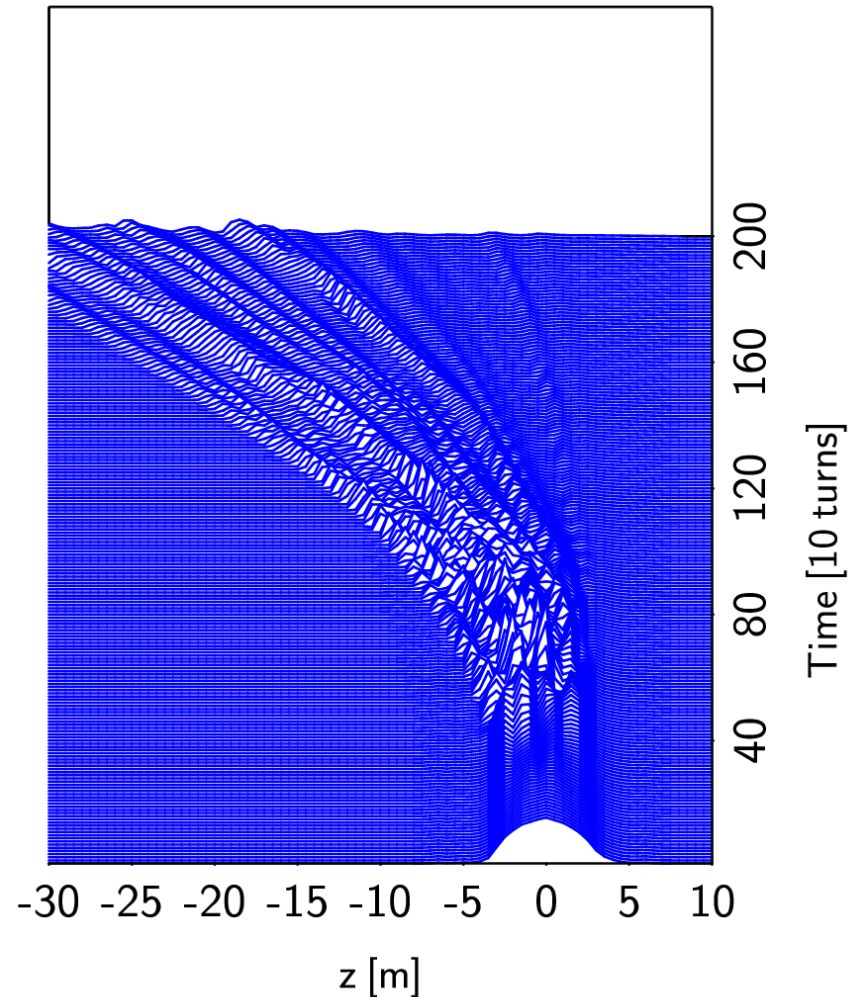

Types of collective effects

- Collective effects start playing a role when the beam density is very high
 - They are also referred to as “high current”, “high intensity”, “high brightness” effects and exhibit a threshold behaviour
 - They result into a measurable response of the beam to the collective interaction, which can be **detrimental and lead to beam degradation and loss**
- **Longitudinal collective effects**
 - Due to self-induced EM fields
 - Energy loss, potential well distortion (synchronous phase shift, bunch lengthening)
 - Instabilities (single or coupled bunch instabilities, microwave instability)
- **Collisional effects (transverse and longitudinal)**
 - Due to scattering
 - Tend to depopulate the denser beam core and degrade emittance and lifetime, similar to what is caused by incoherent collective effects.

Types of collective effects

- Collective effects start playing a role when the beam density is very high
 - They are also referred to as “high current”, “high intensity”, “high brightness” effects and exhibit a threshold behaviour
 - They result into a measurable response of the beam to the collective interaction, which can be **detrimental and lead to beam degradation and loss**
- **Longitudinal collective effects**
 - Due to self-induced EM fields
 - Energy loss, potential well distortion (synchronous phase shift, bunch lengthening)
 - Instabilities (single or coupled bunch instabilities, microwave instability)
- **Collisional effects (transverse and longitudinal)**
 - Due to scattering
 - Tend to depopulate the denser beam core and degrade emittance and lifetime, similar to what is caused by incoherent collective effects.
- **Two-stream effects (transverse and longitudinal)**
 - Due to the interaction with another set of charged particles (e.g. electron cloud)
 - Can cause coherent motion as well as incoherent emittance growth and losses

Electron cloud instability

An example

- Electron cloud instability
 - A coherent instability is visible for the last bunches of a train (BPM signal and beam losses), because an electron cloud has formed along the train and can only make these bunches unstable

48b injection test in LHC (26/08/11)

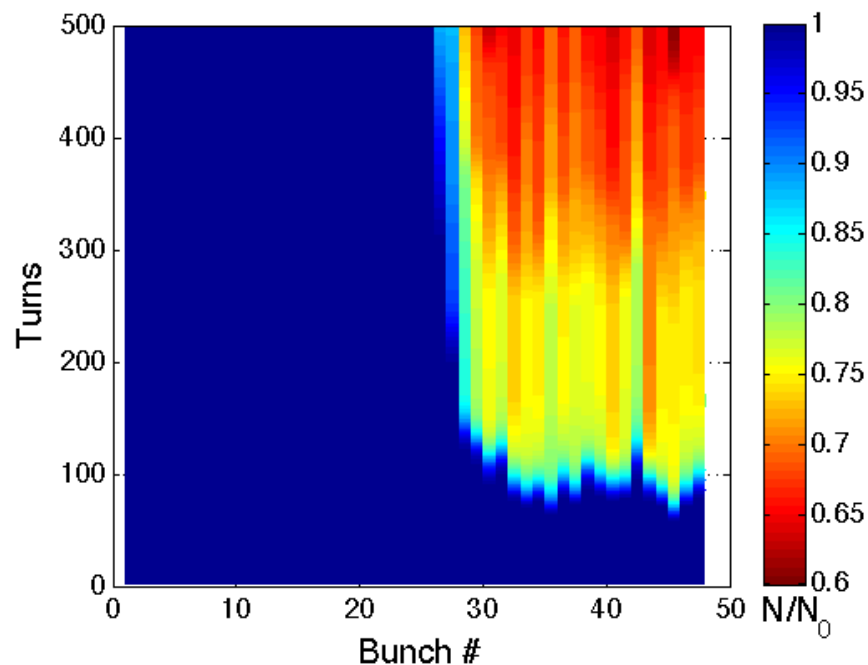
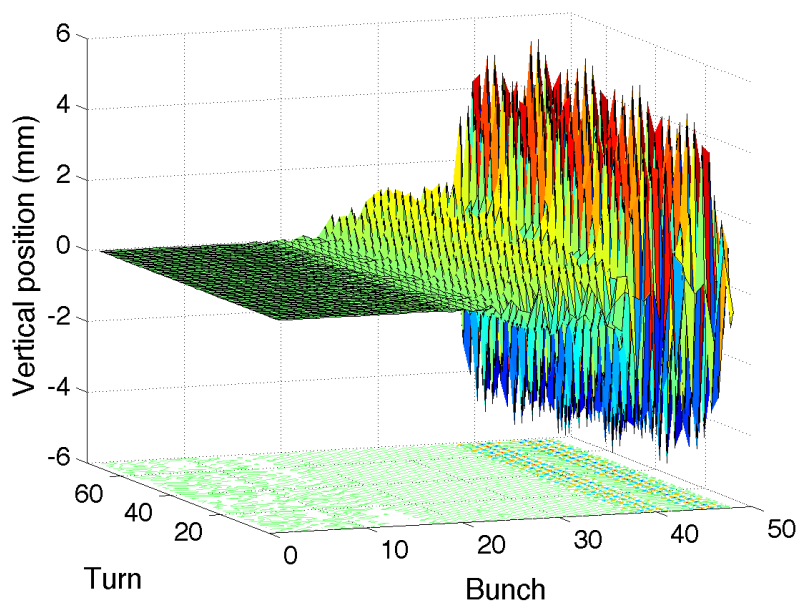

Modeling of collective effects

- Self-induced EM fields
 - Single particle motion under the overall effect of externally applied fields (RF, magnets) and those created by the beam itself with the proper boundary conditions.
- **No single particle dynamics, need to describe a system of many particles**
 - ✓ **Theory:** kinetic models based on distribution functions (Vlasov-Maxwell)

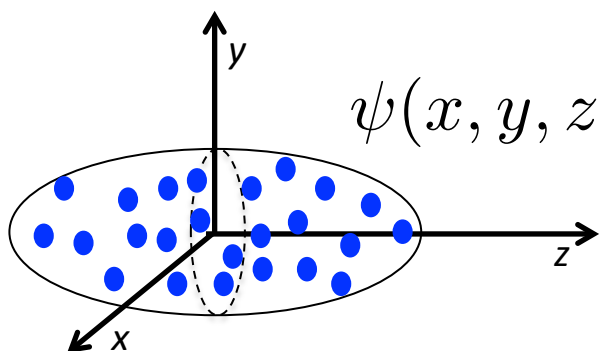

$$\psi(x, y, z, x', y', \delta, t)$$

$$\frac{d\psi}{dt} = 0 \quad \longleftrightarrow \quad \begin{cases} \vec{E} = \vec{E}_{\text{ext}} + \vec{E}(\psi) \\ \vec{B} = \vec{B}_{\text{ext}} + \vec{B}(\psi) \end{cases}$$

in Maxwell's equations

Modeling of collective effects

- Self-induced EM fields
 - Single particle motion under the overall effect of externally applied fields (RF, magnets) and those created by the beam itself with the proper boundary conditions.
- **No single particle dynamics, need to describe a system of many particles**
 - ✓ **Theory:** kinetic models based on distribution functions (Vlasov-Maxwell)
 - ✓ **Simulation:** solve numerically the equations of motion of a set of macroparticles and use the EM fields of the macroparticle distribution

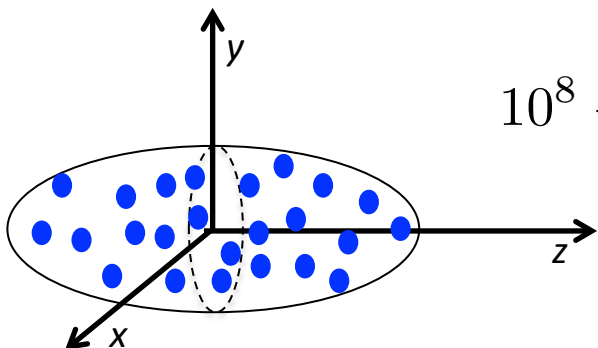

$10^8 - 10^{11}$ particles \longrightarrow $10^4 - 10^6$ macroparticles

$$\frac{d\vec{p}_{\text{mp}}}{dt} = q \left(\vec{E} + \vec{v}_{\text{mp}} \times \vec{B} \right)$$

$$\begin{cases} \vec{E} = \vec{E}_{\text{ext}} + \vec{E}(\psi_{\text{mp}}) \\ \vec{B} = \vec{B}_{\text{ext}} + \vec{B}(\psi_{\text{mp}}) \end{cases}$$

Modeling of collective effects

- Self-induced EM fields
 - Single particle motion under the overall effect of externally applied fields (RF, magnets) and those created by the beam itself with the proper boundary conditions.
- **No single particle dynamics, need to describe a system of many particles**
 - ✓ **Theory:** kinetic models based on distribution functions (Vlasov-Maxwell)
 - ✓ **Simulation:** solve numerically the equations of motion of a set of macroparticles and use the EM fields of the macroparticle distribution
 - ❑ **Direct space charge** refers to the EM fields created by the beam as if it was moving in open space,
 - ❑ **Impedances** are used to describe EM interaction of beam with boundaries



Modeling of collective effects

- Self-induced EM fields + Coulomb collisions
 - Single particle motion under the overall effect of externally applied fields (RF, magnets) and those created by the beam itself with the proper boundary conditions.

- **No single particle dynamics, need to describe a system of many particles**
 - ✓ **Theory:** kinetic models based on distribution functions (Vlasov-Maxwell)
 - ✓ **Simulation:** solve numerically the equations of motion of a set of macroparticles

- ✦ **Probability of close encounters can be included through the appropriate models**

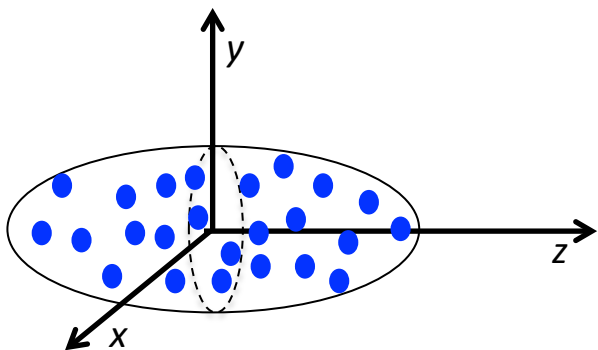

$$\frac{d\psi}{dt} = \left(\frac{\partial\psi}{\partial t} \right)_{\text{coll}} \longleftrightarrow \begin{cases} \vec{E} = \vec{E}_{\text{ext}} + \vec{E}(\psi) \\ \vec{B} = \vec{B}_{\text{ext}} + \vec{B}(\psi) \end{cases}$$

Vlasov-Fokker-Planck formalism

Modeling of collective effects

- EM fields from another charge distribution
 - Single particle motion under the overall effect of externally applied fields (RF, magnets) and those created by the second “beam”.
- **No single particle dynamics, need to describe evolution (and sometimes generation) of the other system of particles to derive its EM fields**
 - ✓ **Theory:** simplified models to include the effect of the second “beam”
 - ✓ **Simulation:** describe numerically the second “beam” and calculate its fields as driving terms in the equations of motion of the set of macroparticles representing the beam

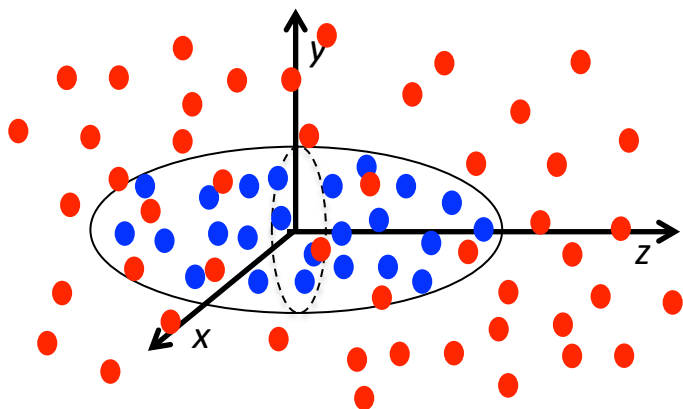

$$\frac{d\vec{p}_{\text{mp1,mp2}}}{dt} = q \left(\vec{E} + \vec{v}_{\text{mp1,mp2}} \times \vec{B} \right)$$

$$\begin{cases} \vec{E} = \vec{E}_{\text{ext}} + \vec{E}(\psi_{\text{mp1}}, \psi_{\text{mp2}}) \\ \vec{B} = \vec{B}_{\text{ext}} + \vec{B}(\psi_{\text{mp1}}, \psi_{\text{mp2}}) \end{cases}$$

- Space charge
 - Low energy machines
- Machine impedance
- Electron cloud
 - Machines with short bunch spacing

- **Space charge**
 - **Low energy machines**
- Machine impedance
- Electron cloud
 - Machines with short bunch spacing

Direct space charge

- Simple calculation of direct space charge
 - Cylindrical distribution
 - Calculate electric and magnetic forces acting on each beam particle through Maxwell's equations
 - The electric and magnetic components have different signs and differ by a factor β^2 . Perfect cancellation only when $\beta = 1$

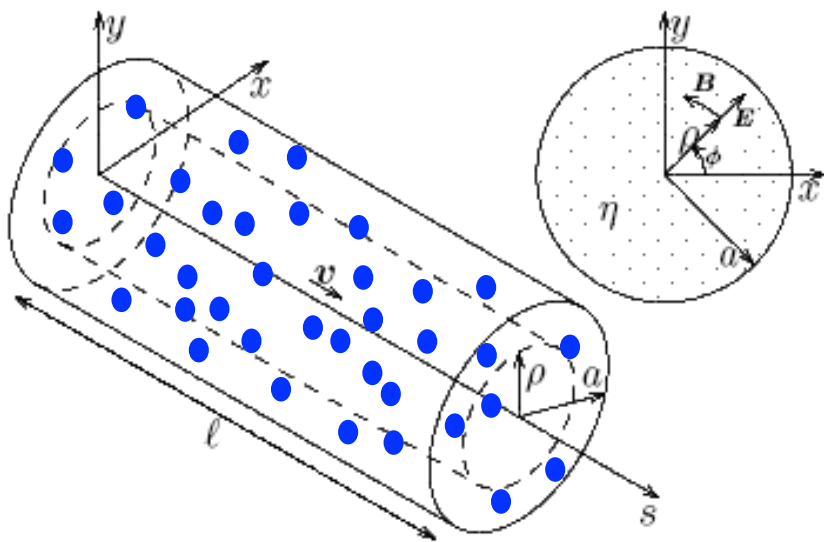

$$\begin{aligned}
 \vec{F} &= \vec{F}_E + \vec{F}_B = e \left(\vec{E} + \vec{v} \times \vec{B} \right) = \\
 &= \frac{e\lambda\vec{\rho}}{2\epsilon_0\pi a^2} (1 - \beta^2) = \frac{e\lambda\vec{\rho}}{2\pi\epsilon_0\gamma^2 a^2} \\
 &= \frac{e\lambda}{2\pi\epsilon_0\gamma^2 a^2} \cdot (x \cdot \hat{x} + y \cdot \hat{y})
 \end{aligned}$$

Direct space charge

- Space charge is a constant defocusing force in both x and y. For instance, in the vertical plane:
 - Corresponds to a continuous gradient error $dK(s)=dy'(s)/y$ along the ring
 - Translates into contributions to the tune shift $dQ_y(s)$
 - Can be integrated all over the circumference $C = 2\pi R$ to provide the total tune shift ΔQ_y for each particle (which is a tune spread over the beam)

$$dQ_y(s) = -\frac{\beta_y(s)}{4\pi} \frac{dy'(s)}{y} = -\frac{r_0 \lambda \beta_y(s) ds}{2\pi e \beta^2 \gamma^3 a^2(s)}$$

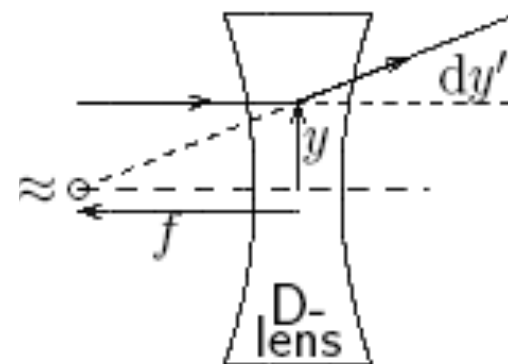

$$\Delta Q_y = \oint dQ_y(s) = -\frac{r_0 \lambda}{2\pi e \beta^2 \gamma^3} \oint \frac{\beta_y(s) ds}{a^2(s)} = -\frac{r_0 \lambda R}{e \beta \gamma^2 \epsilon_{yn}}$$

Direct space charge

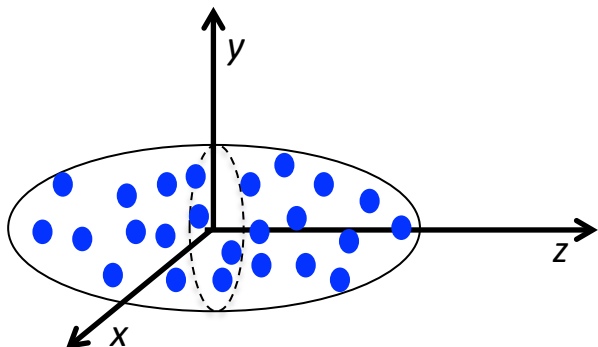

$$\Delta Q_{x,y} = - \frac{r_0 \lambda_{\max} C}{2\pi e \beta \gamma^2 \epsilon_{xn,yn}}$$

$$\propto \lambda_{\max}$$

Bunches with **higher peak current** suffer larger space charge tune spreads

$$\propto 1/\epsilon_n$$

Lower emittance bunches suffer larger space charge tune spreads

$$\propto 1/(\beta \gamma^2)$$

Lower energy beams suffer larger space charge tune spreads

$$\propto C$$

Longer machines can build up larger space charge tune spreads

Direct space charge: the PSB

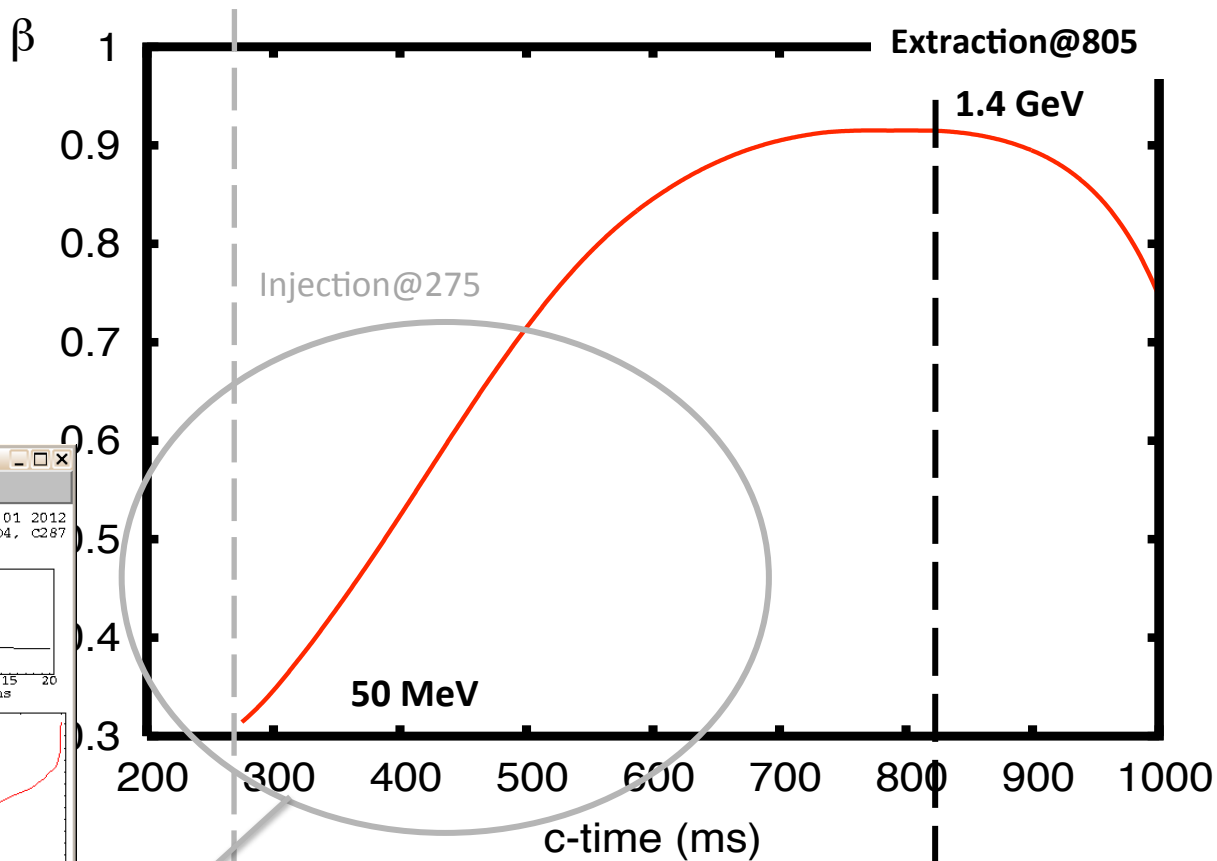

- The PSB accelerates bright beams from 50 MeV to 1.4 GeV over 530 ms
- Space charge important, especially in first part of the cycle – bunch is flattened through a second harmonic RF system

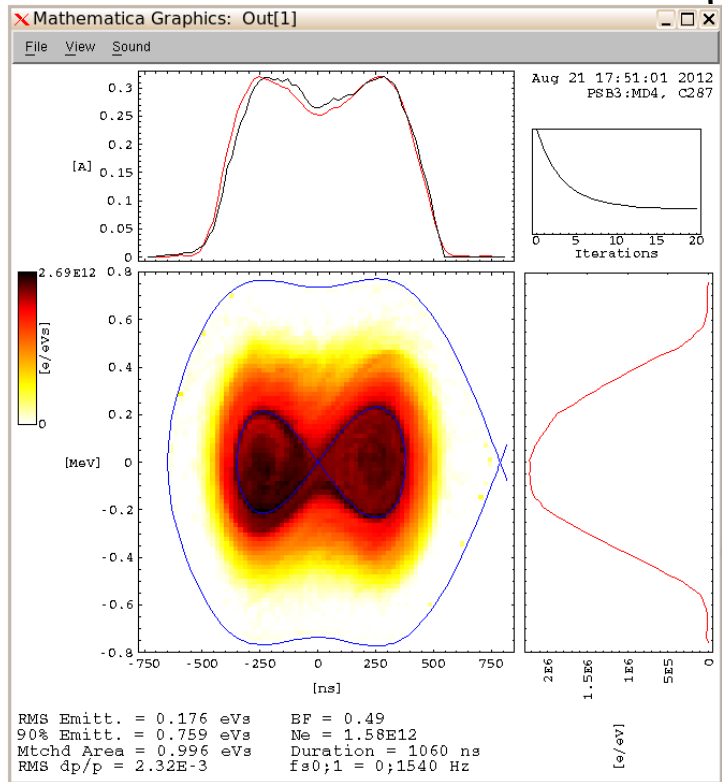

Space charge tune spread in PSB

What helps against space charge:

- Acceleration all along the cycle
- Dynamic working point
- Active compensation of resonances with multipoles

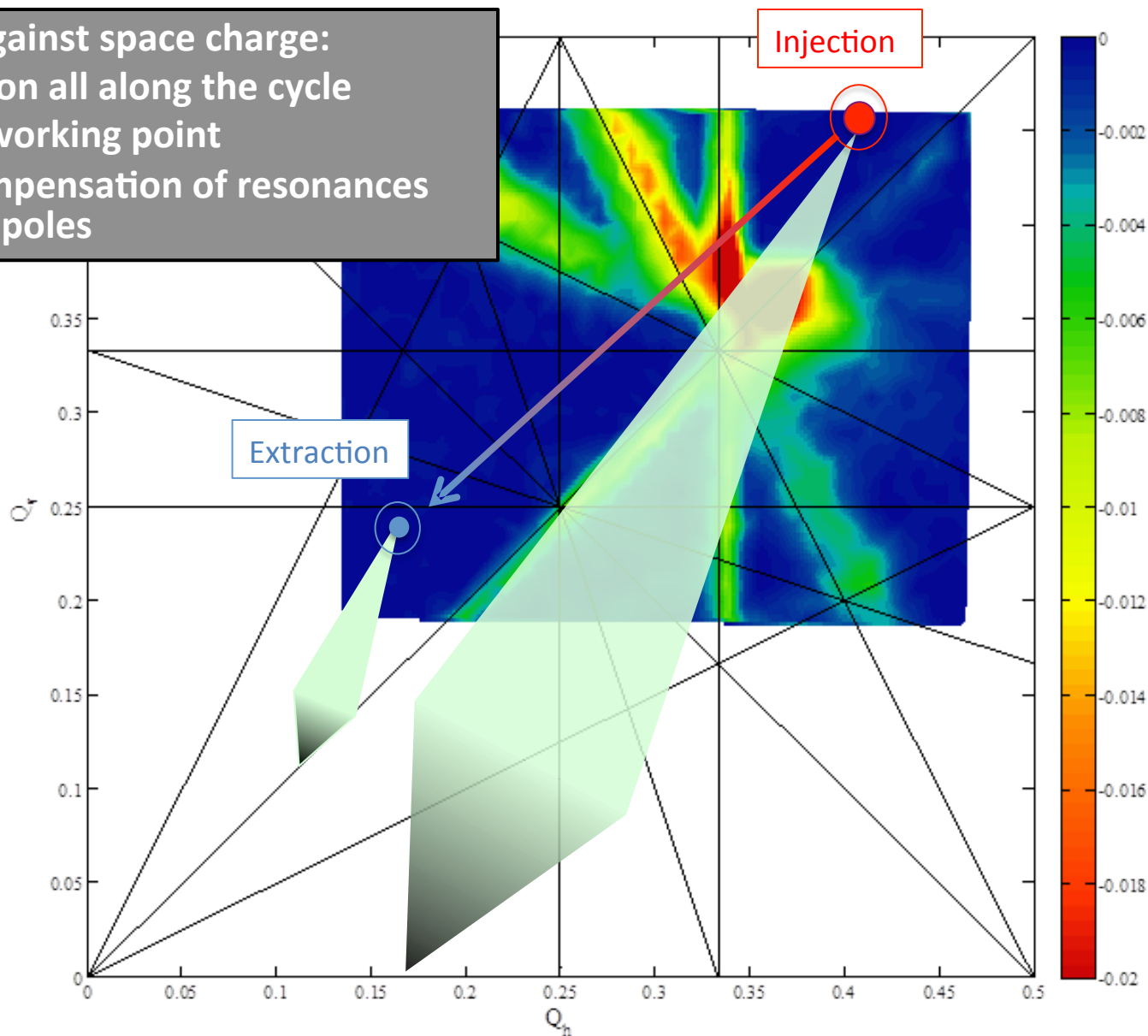

Direct space charge: the PS

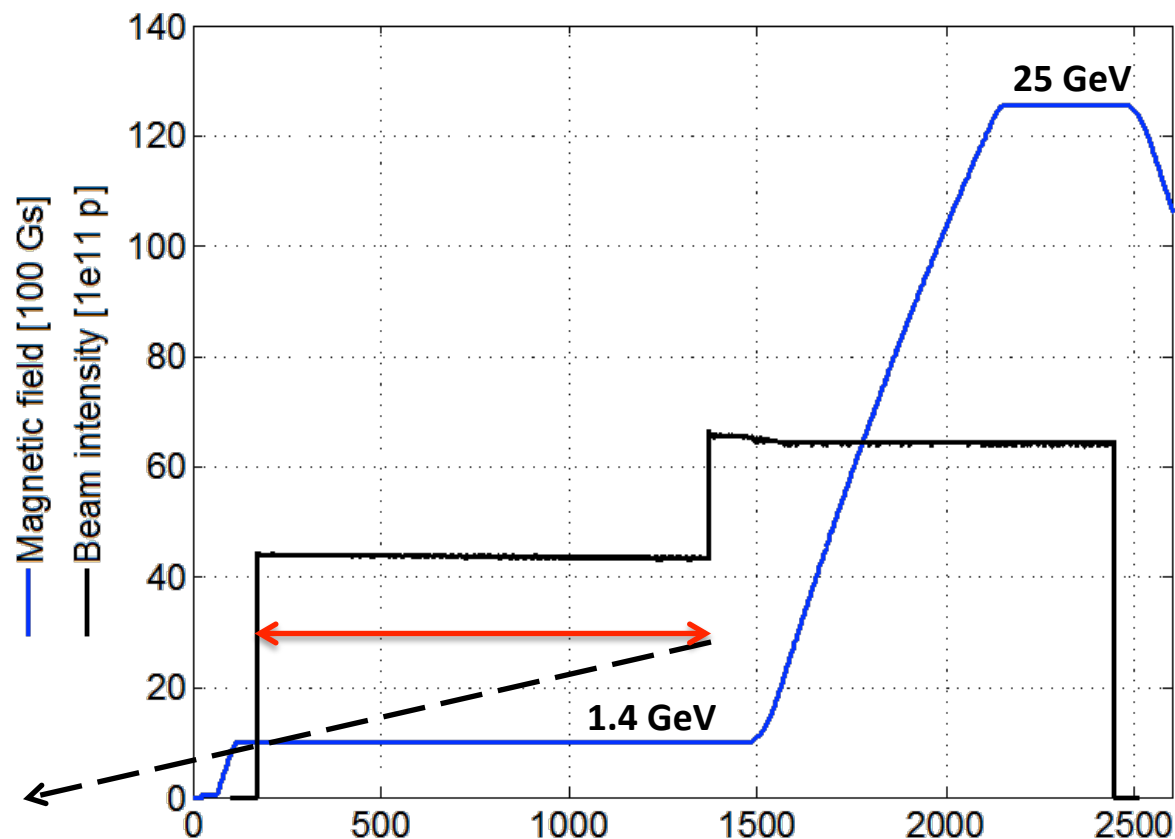
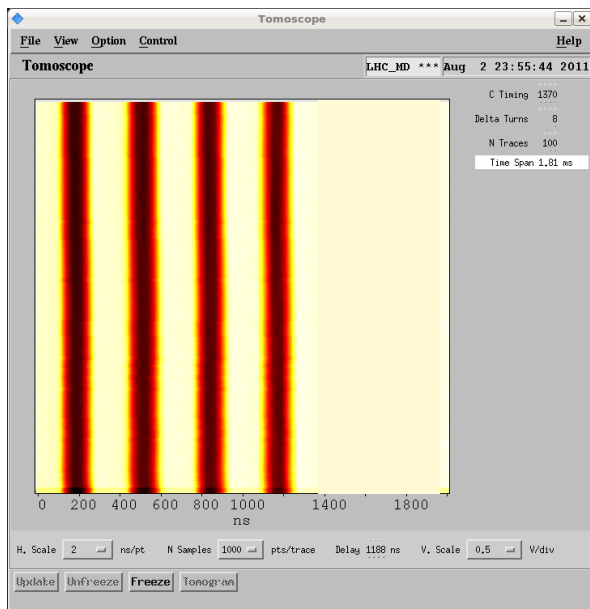

- First four bunches from PSB circulate in PS for **1.2 s** and can suffer losses and emittance growth due to space charge
- The PS receives other two bunches from the PSB just before acceleration

Space charge tune spread in PS

- Tune spread necktie close to integer at injection for nominal working point and high intensity LHC beam

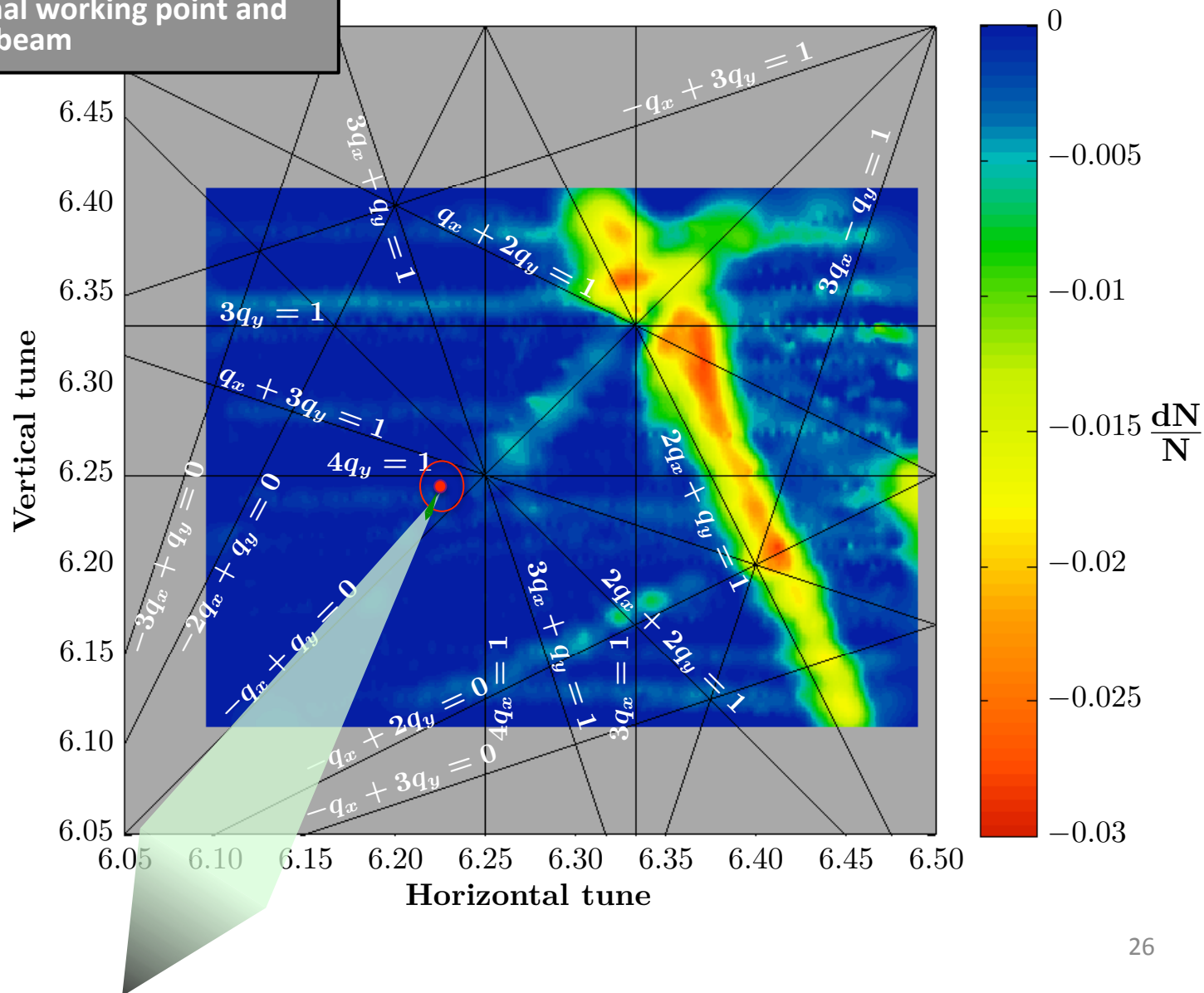

Space charge tune spread in PS

Large tune spreads translate into important emittance growth!!!

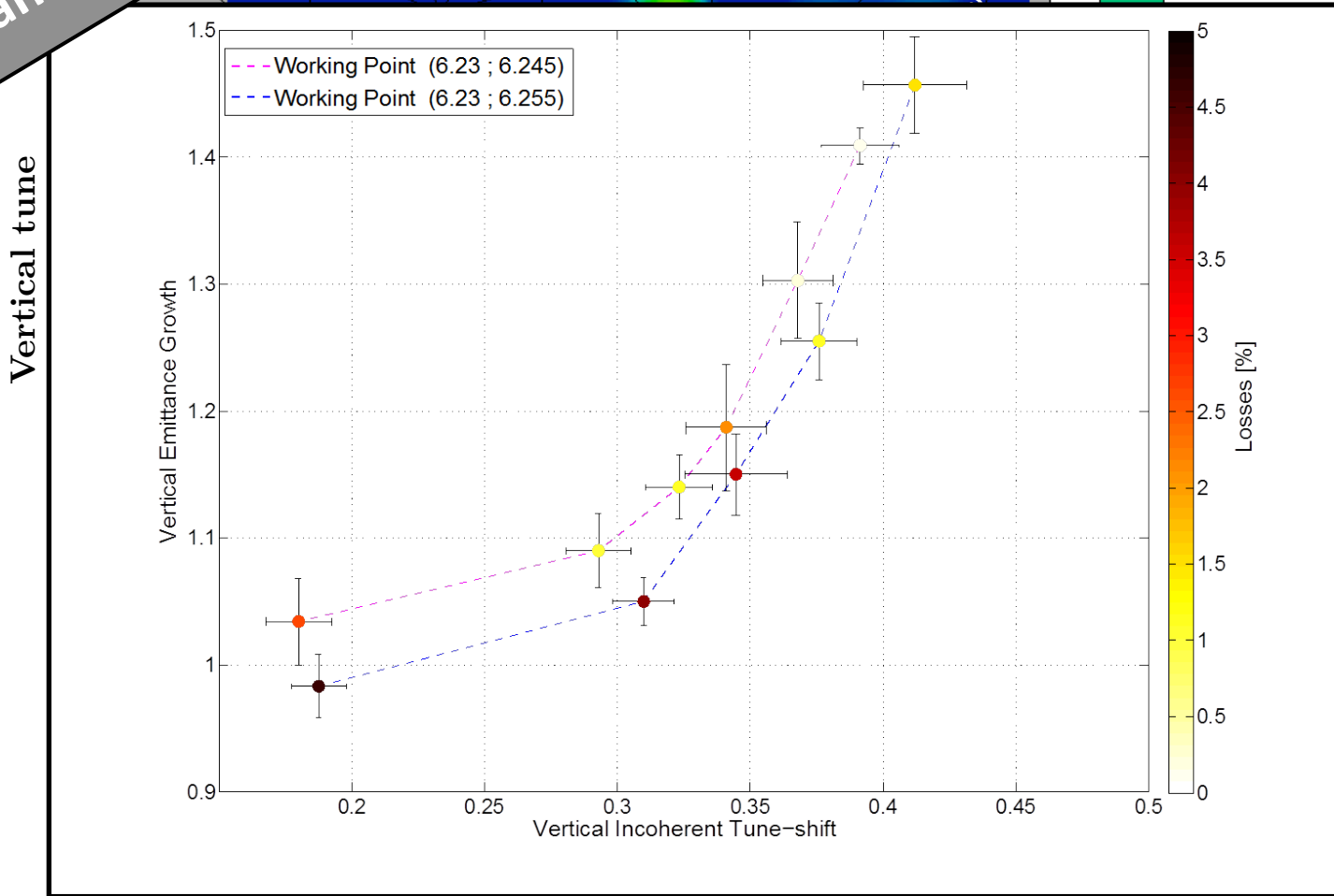
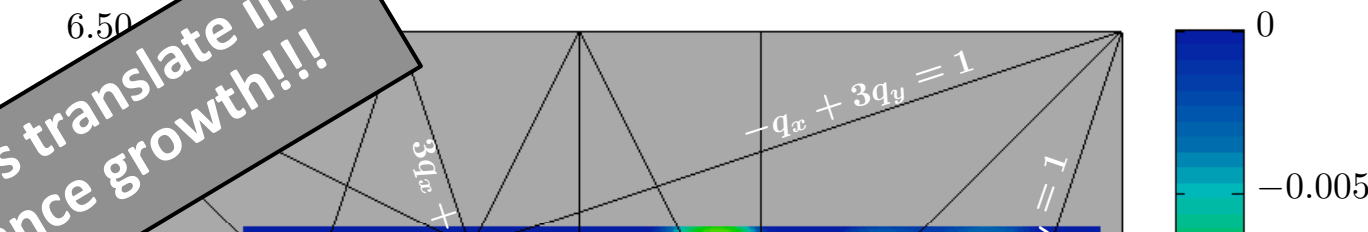

Space charge tune spread in PS

- Tune spread necktie close to integer at injection for nominal working point and high intensity LHC beam
- Need to adjust working point to avoid losses and emittance growth
- For even higher bunch currents, need to upgrade the injection energy into the PS to 2 GeV!

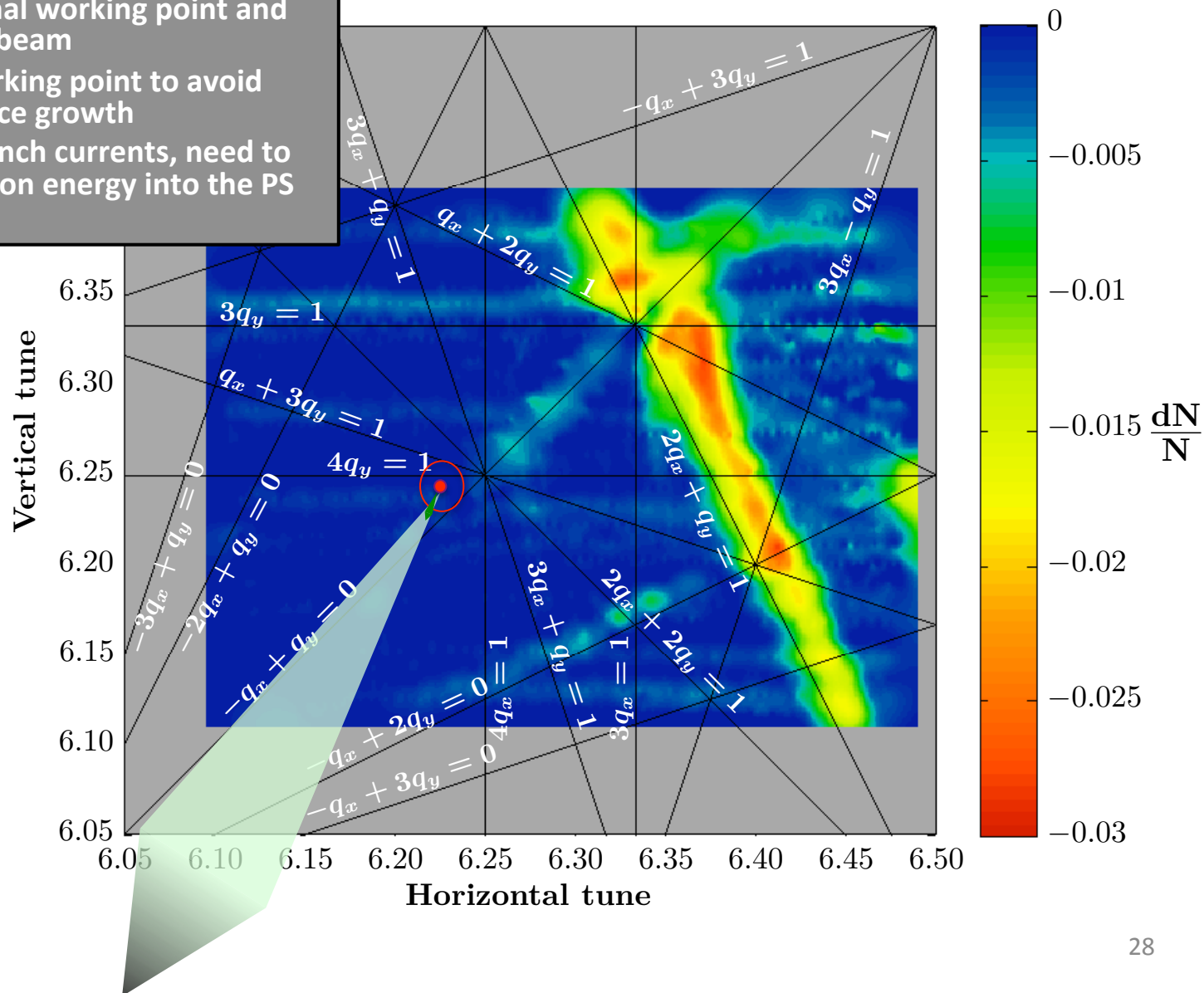

- Space charge
 - Low energy machines
- **Machine impedance**
- Electron cloud
 - Machines with short bunch spacing

The wake field

The impedance in frequency domain is a wake field in time domain
→ Long lived wake means narrow band impedance



A PILL-BOX CAVITY

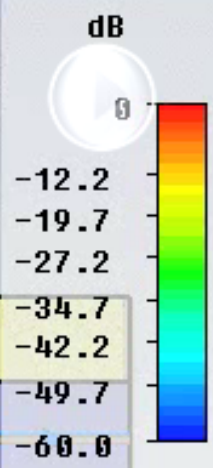
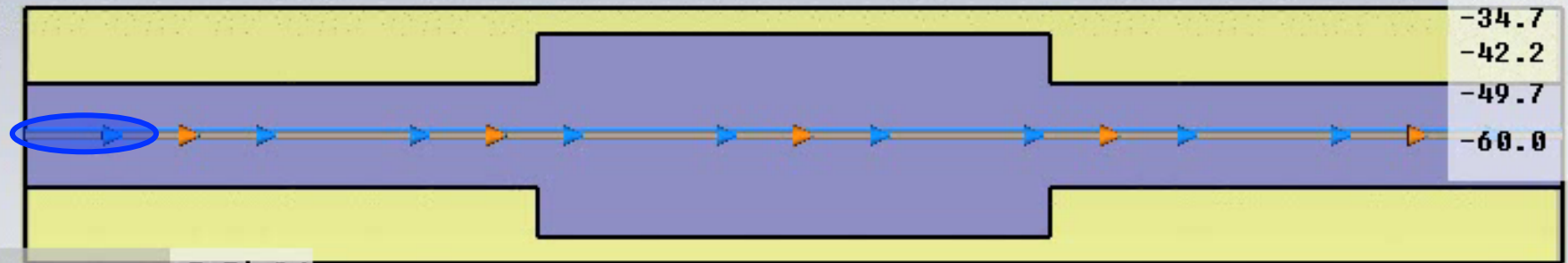

| | |
|------------|--|
| Type | E-Field |
| Monitor | e-field (t=0..end(0.1);x=0) [pb] |
| Component | y |
| Plane at x | 0 |
| Maximum-2D | 784201 U/m (= 0 dB) at 0 / 0 / 9.84691 |
| Sample | 1 / 112 |
| Time | 0 |



The wake field

The impedance in frequency domain is a wake field in time domain
→ Short lived wake means broad band impedance

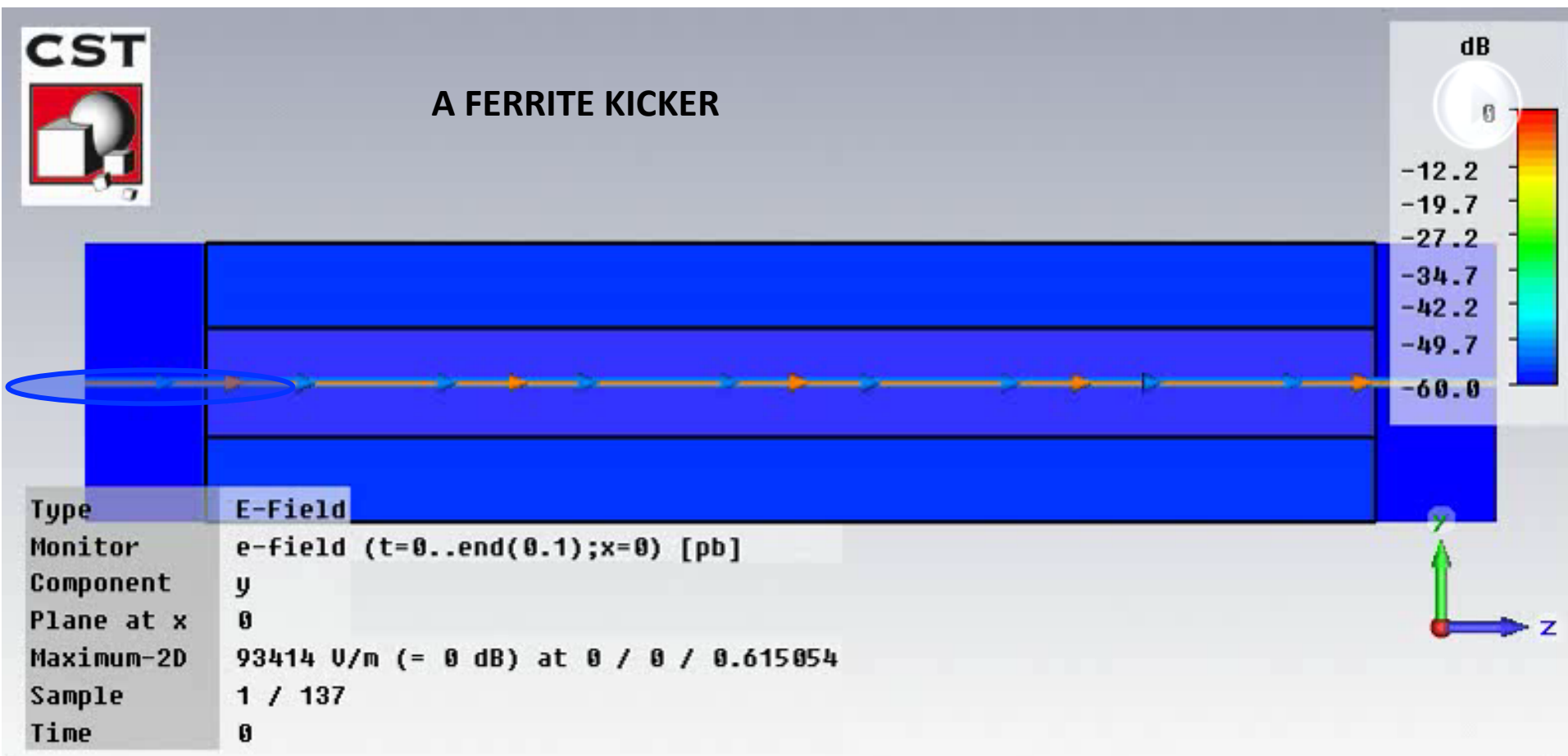

Wake field \rightarrow Impedance

Cavity: example of structure with resonating modes (narrow band)

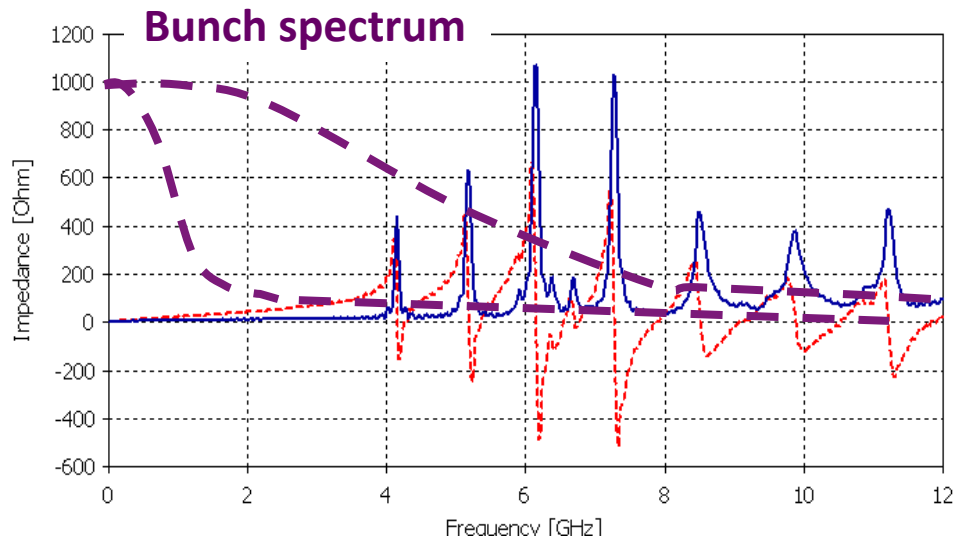
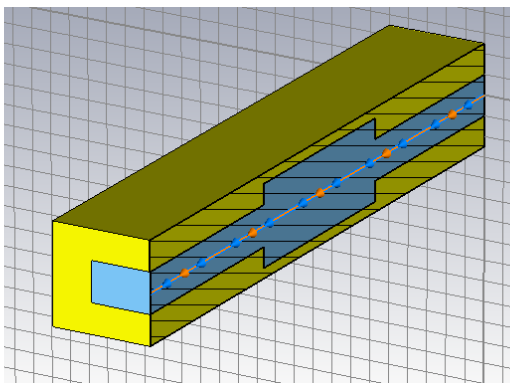

Kicker: example of structure with quickly decaying wake (broad band)

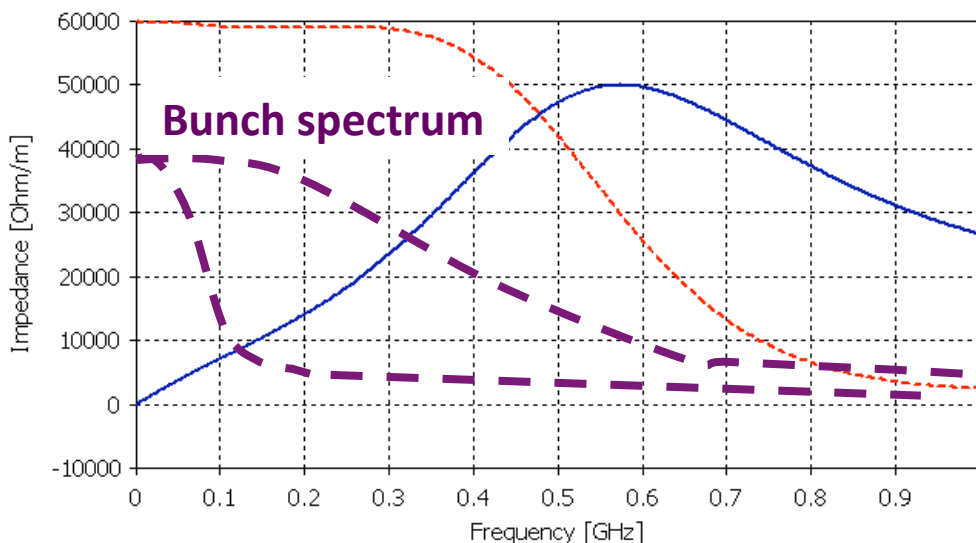
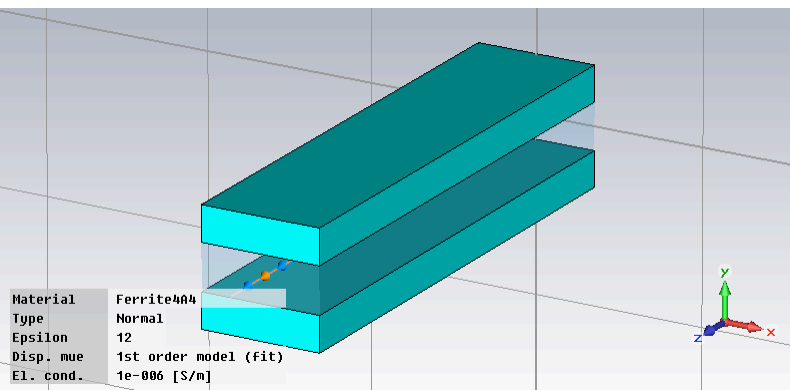

Effects of the impedance

- When a **bunch propagates in a resistive pipe or is exposed to ferric material**, its wake field has a fast decay and can either couple its head and tail or couple it to few subsequent bunches
 - When a **bunch encounters a discontinuity** (e.g., cavity, diagnostics device), its wake field can partly remain trapped in the structure and resonate for long time. Thus, it may affect several subsequent bunches, or even itself over several turns
 - In either case, the **bunch loses energy** on the production of the EM field
- Tune shift, single bunch or single train instabilities
- Tune shift, coupled bunch or multi-turn instabilities
- Beam energy loss (compensated by the RF) + beam induced heating

Example in the PS

Transverse instability at transition

- Vertical instability of single bunch observed when approaching transition
- Can be suppressed with γ -jump scheme and optimized chromaticity trim

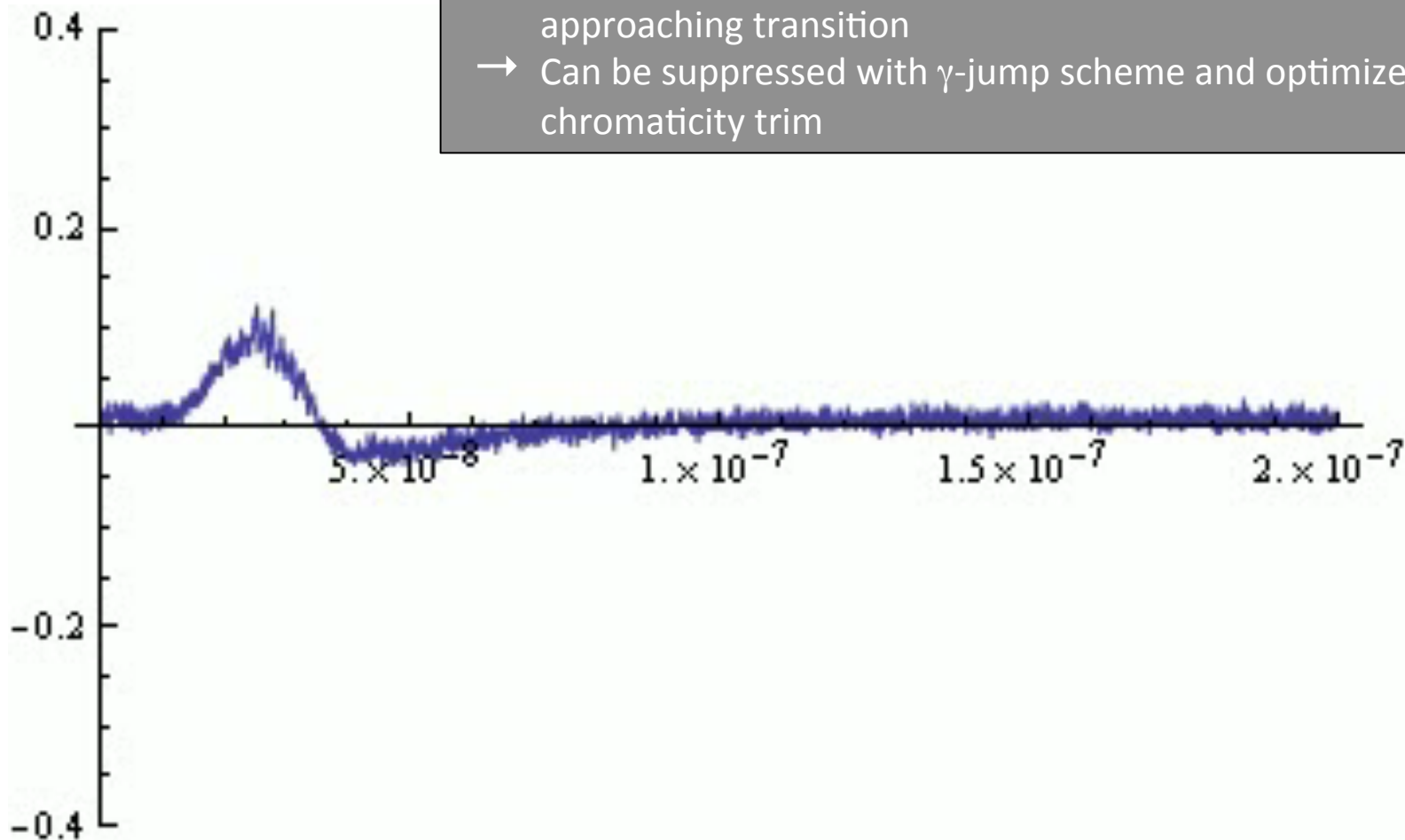

Example in the PS

Transverse instability at transition

- Vertical instability of single bunch observed when approaching transition
- Can be suppressed with γ -jump scheme and optimized chromaticity trim

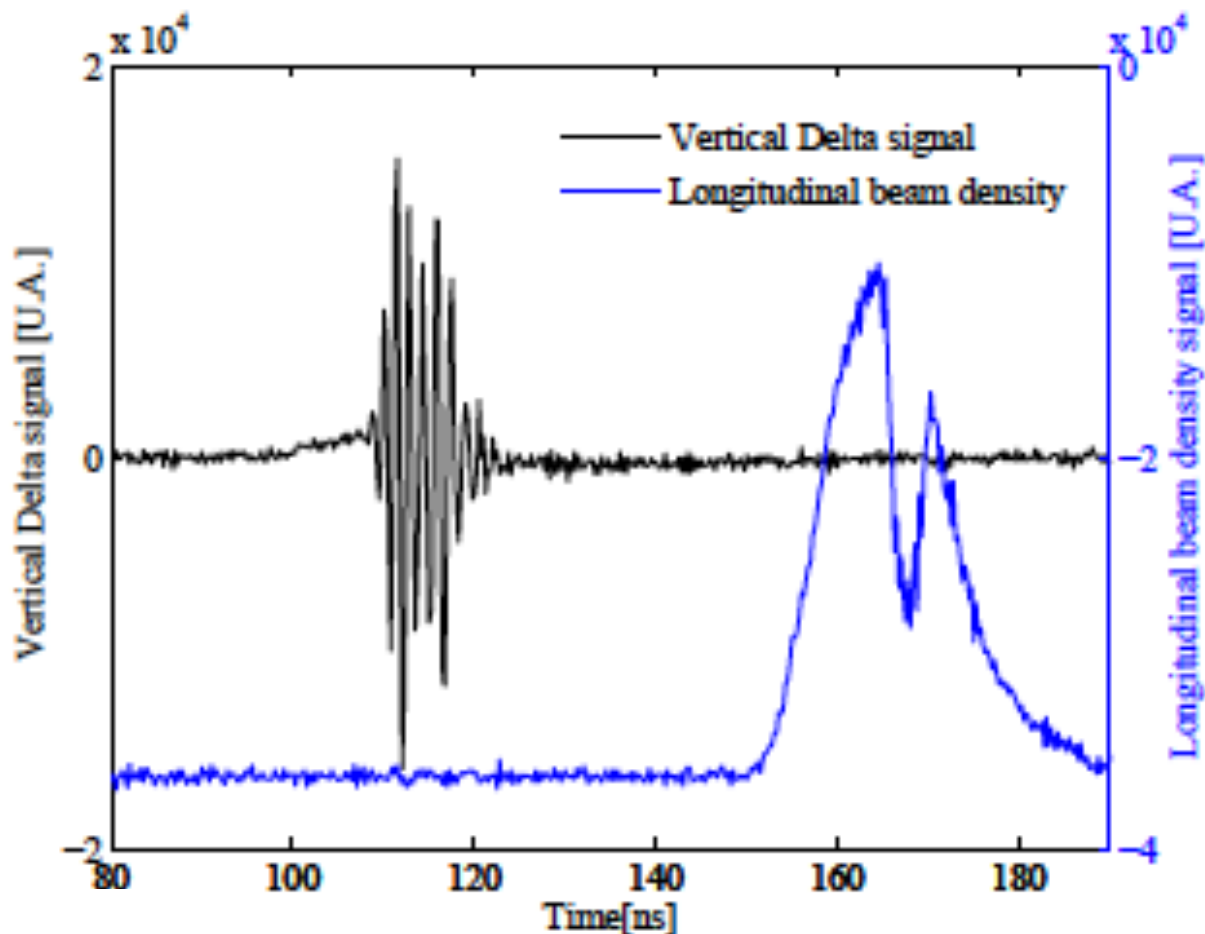

Example in the SPS

Transverse instability at injection

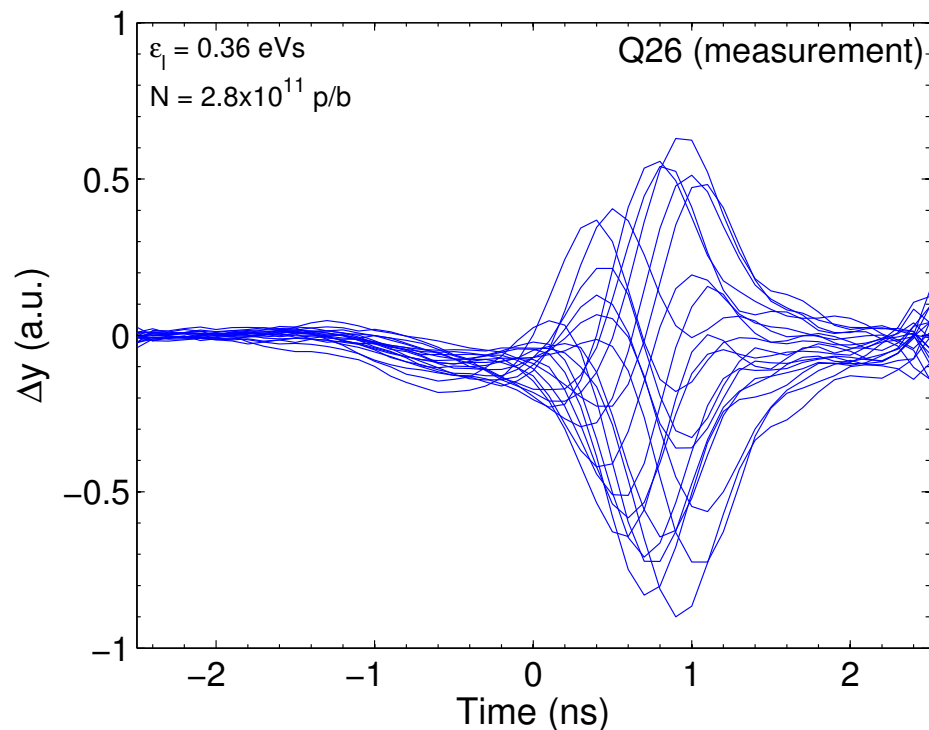
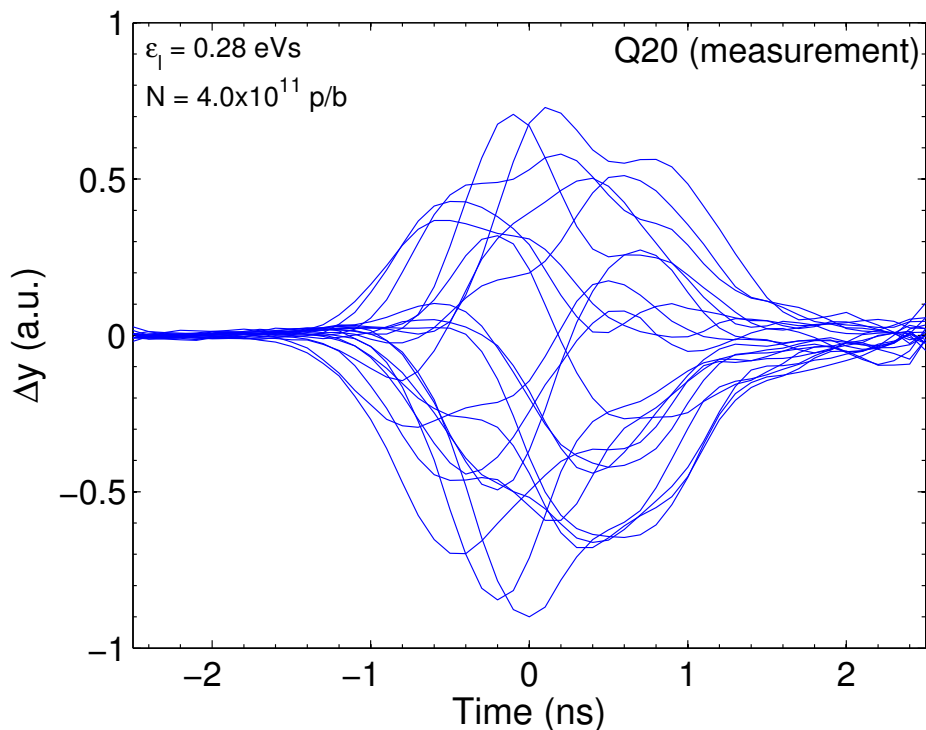

- Vertical instability of single bunch observed at 26 GeV/c on two different optics (Q20 and Q26)
- Higher intensity achievable in Q20 before becoming unstable (thanks to the larger η)

Example in the SPS

Extraction kicker heating

MKE

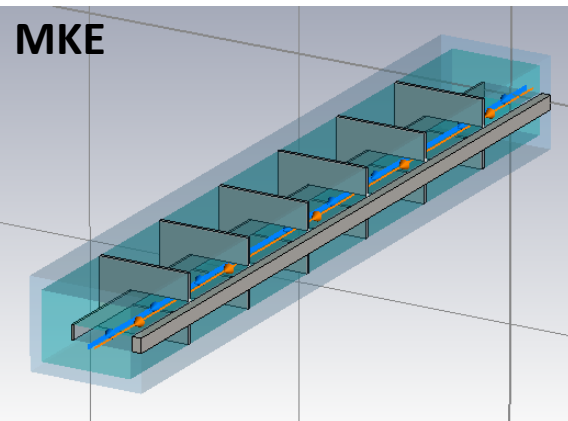

MKE with serigraphy

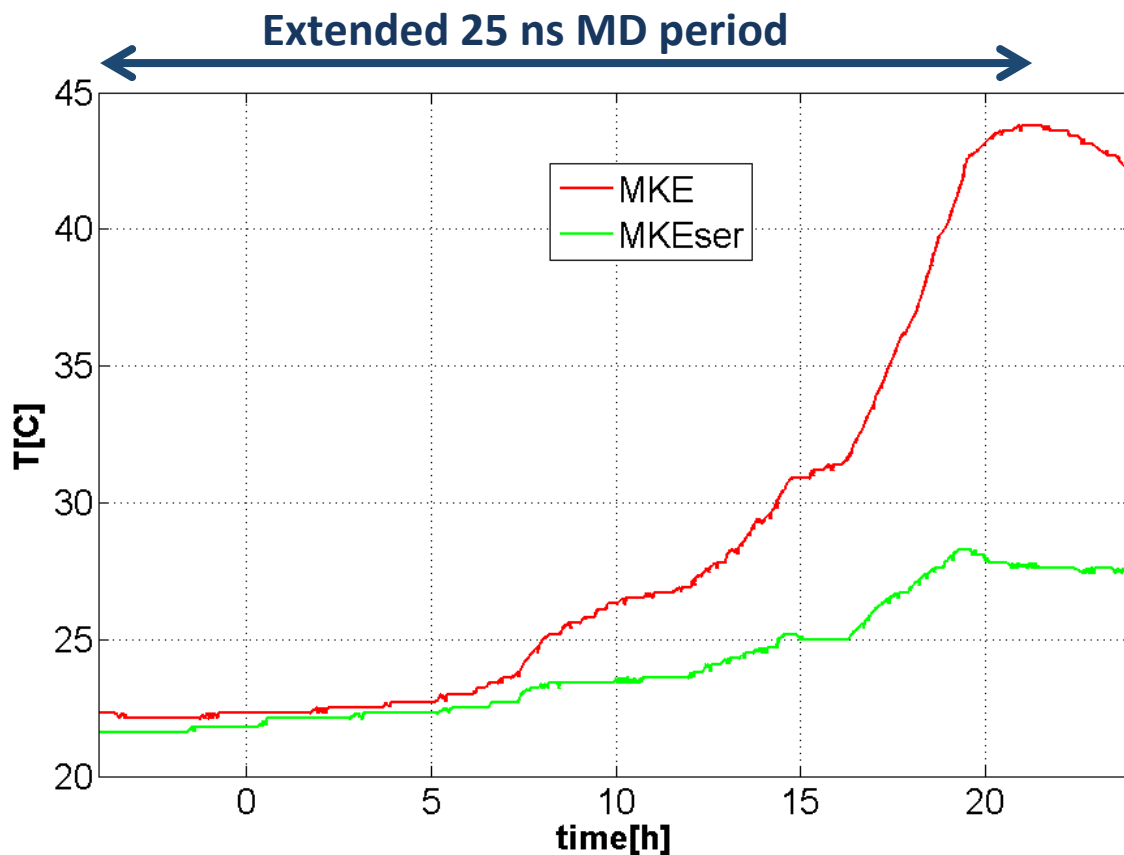
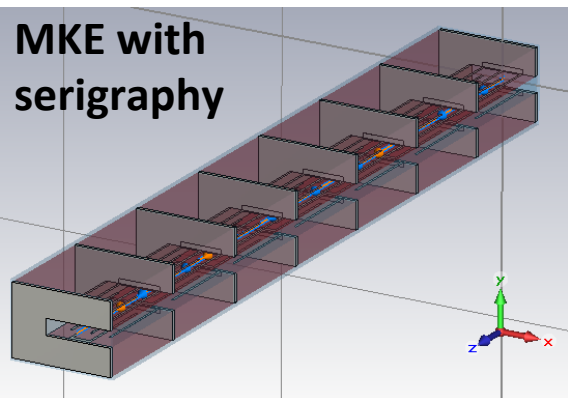

- Extraction kickers (MKEs) heat significantly during operation with 25 ns beams
- Printing a serigraphy on the ferrite can reduce the heating

Example from LEP

Head-tail oscillation

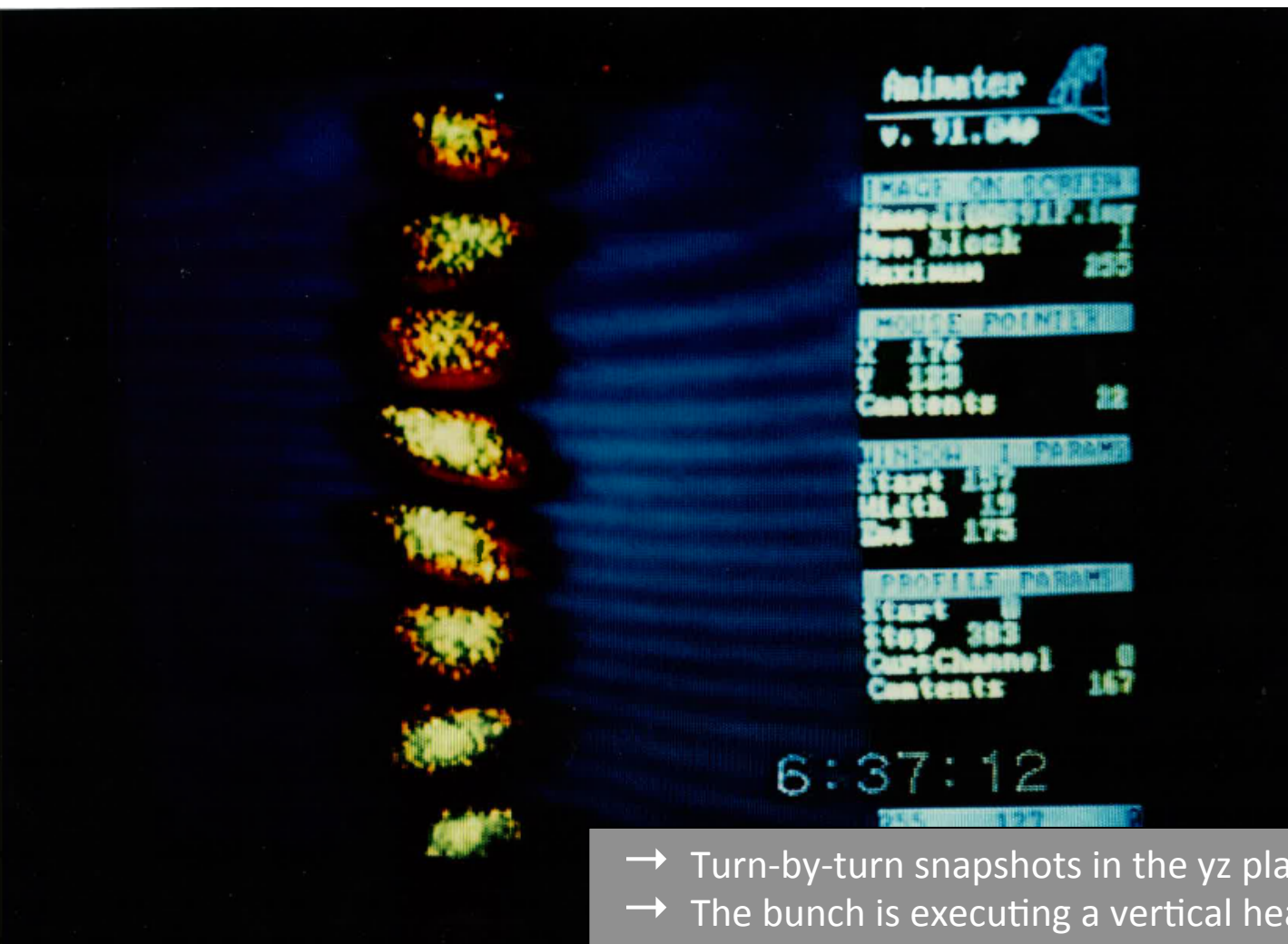

- Turn-by-turn snapshots in the yz plane of a bunch (500 ps)
- The bunch is executing a vertical head-tail oscillation (mode l=1)

How to fight impedance effects

In running accelerators the **impedance effects are mitigated** relying on some mechanisms (passive or active)

- **Spreads and nonlinearities** stabilize the beam (through the mechanism of Landau damping)
 - Longitudinal: momentum spread, synchrotron frequency spread (Landau cavity)
 - Transverse: chromaticity, betatron tune spreads (e.g from machine nonlinearities)
 - E.g. octupoles, RFQ)
- **Active feedback systems** are routinely employed to control/suppress all types of instabilities
 - ✓ Coherent motion is detected (pick-up) and damped (kicker) before it can degrade the beam
 - ✓ Sometimes bandwidth/power requirements can be very stringent, but in general very efficient against coupled bunch phenomena
- **Impedance identification and reduction techniques** are applied to old accelerators as well as for the design of new accelerators to extend their performance reach!
 - Longitudinal: efficient to raise longitudinal instability thresholds as well as reduce equipment heating caused by the power loss
 - Transverse: raise transverse instability thresholds and limit incoherent effects

- Space charge
 - Low energy machines
- Machine impedance
- **Electron cloud**
 - **Machines with short bunch spacing**

Electron cloud formation in a vacuum pipe

- Several mechanisms cause **generation of charged particles** inside the vacuum pipe of an accelerator (primary, or seed, electrons):
 1. **Ionization of the residual gas**
 2. Emission of electrons from **photoelectric effect** due to synchrotron radiation hitting the beam pipe
 3. **Electron desorption** from the walls caused by beam loss
- Depending on the chamber size and material, as well as beam structure and parameters:
 - The primary electrons are then accelerated in the beam field and hit the wall typically between bunch passages
 - Their number can multiply upon hitting the pipe wall, due to SEY process.
- After the passage of several bunches, the electron distribution in the chamber comes to a stationary state (dynamic equilibrium) and can act back on the beam, causing instabilities or incoherent effects

Example: photoelectrons

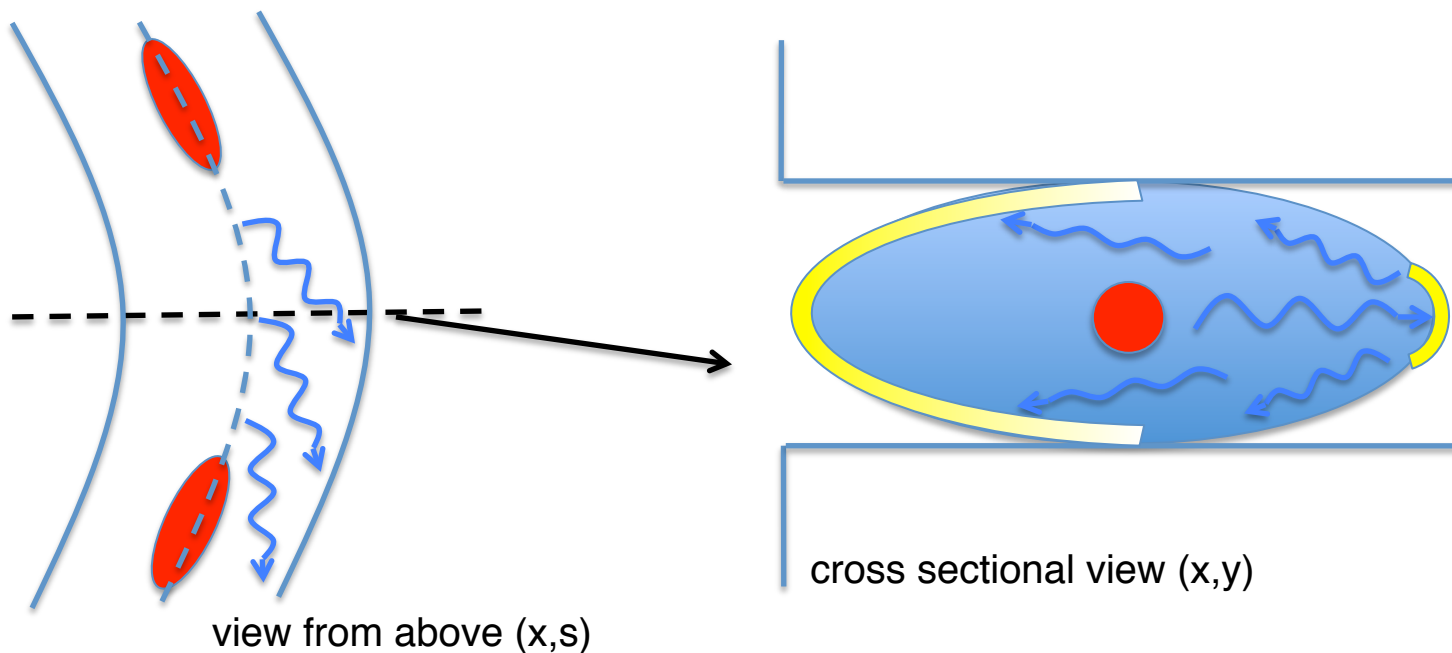

- When the beam is bent in a dipole magnet, it emits **synchrotron radiation** in the horizontal plane (bending plane)
- When the **synchrotron radiation** hits the beam pipe
 - partly it produces electron emission within a $1/\gamma$ angle from the point where it impinges
 - partly it is reflected inside the pipe and hits at different locations, too, producing electrons with a more complex azimuthal distribution.

Secondary electron emission

- When electrons hit the pipe wall, they do not just disappear.....
 - High energy electrons easily survive and actually multiply through **secondary electron emission**
 - Low energy electrons tend to survive long because they are likely to be **elastically reflected**.
- Secondary electron emission is governed by the curve below

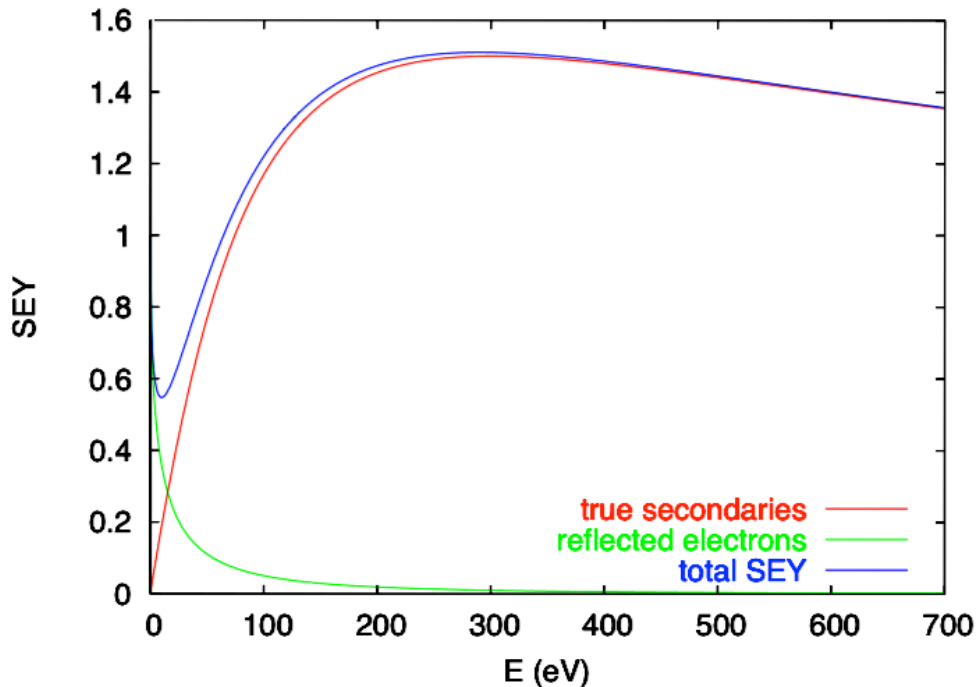
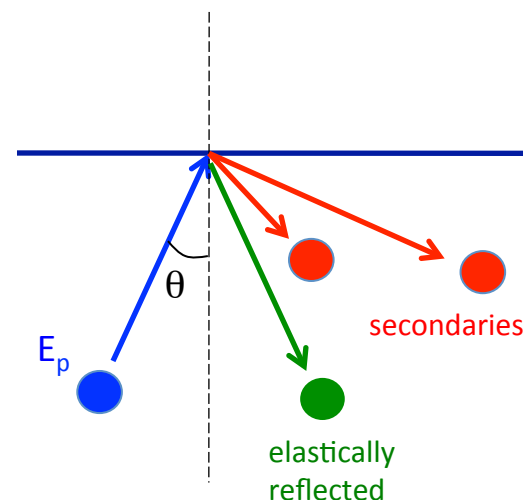

$$\delta_{\text{true}} = \delta_{\text{max}} \frac{sx}{s-1+x^s} \quad x = \frac{E}{E_{\text{max}}}$$

$$\delta_{\text{elas}} = \frac{\left(\sqrt{E} - \sqrt{E + E_0}\right)^2}{\left(\sqrt{E} + \sqrt{E + E_0}\right)^2}$$

$$\delta_{\text{tot}}(E) = \delta_{\text{true}}(E) + R_0 \cdot \delta_{\text{elas}}(E)$$

Electron cloud build up in a dipole magnet (LHC dipole, two trains of 72b)

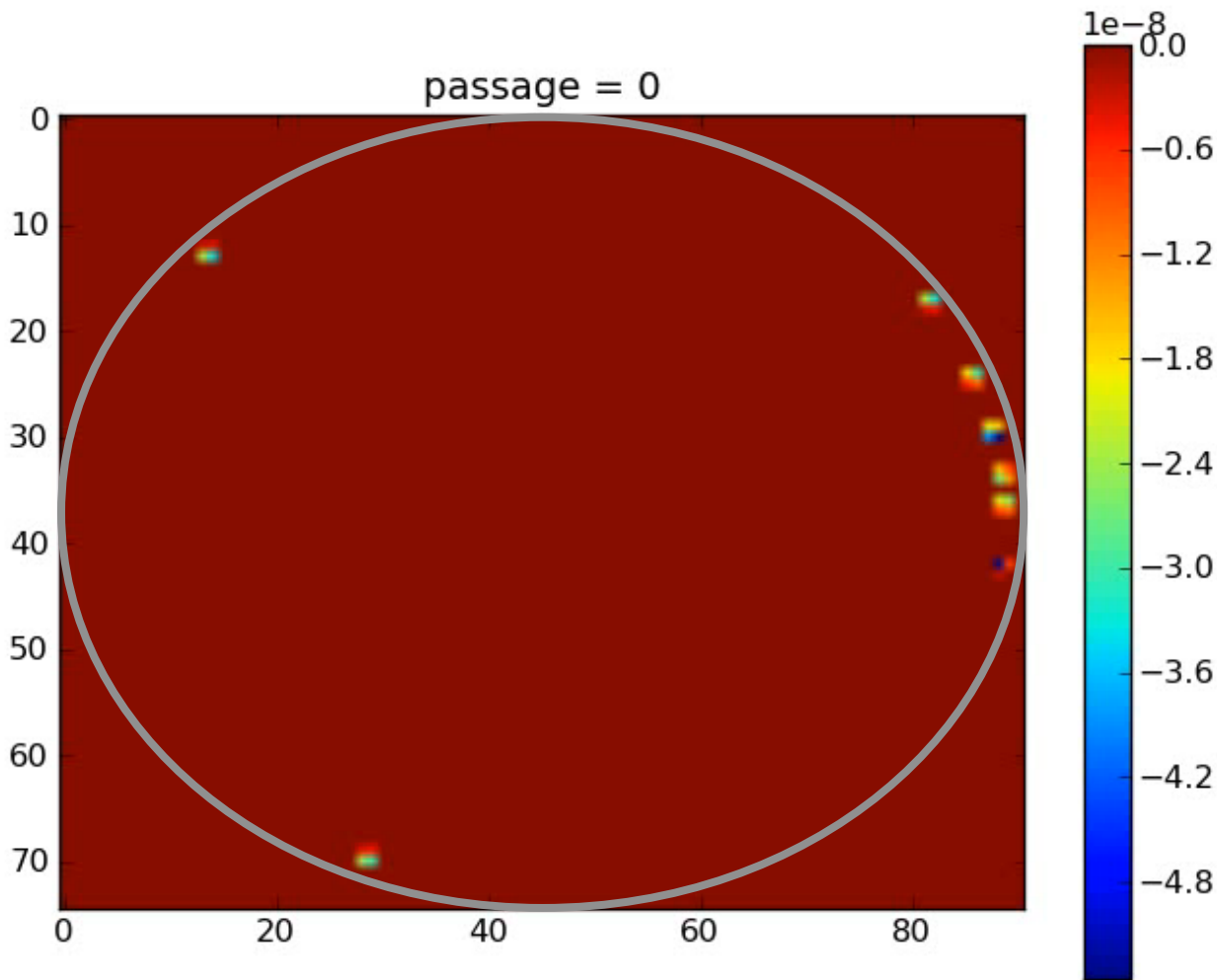

Electron cloud indicators

The presence of an electron cloud inside an accelerator ring is revealed by several **typical signatures**

- ✓ Fast **pressure rise, outgassing**
 - ✓ Additional **heat load**
 - ✓ Baseline shift of the **pick-up** electrode signal
 - ✓ **Tune shift** along the bunch train
 - ✓ **Coherent instability** of the last bunches of a train
 - ✓ Beam size blow-up and **emittance growth**
 - ✓ **Luminosity loss** in colliders
 - ✓ **Energy loss** measured through the **synchronous phase shift**
 - ✓ Active monitoring: signal on dedicated electron **detectors** (e.g. strip monitors) and **retarding field analysers**
- Machine observables
- Beam observables

Electron cloud in LHC

injection tests of 25 ns beams (July 2012)

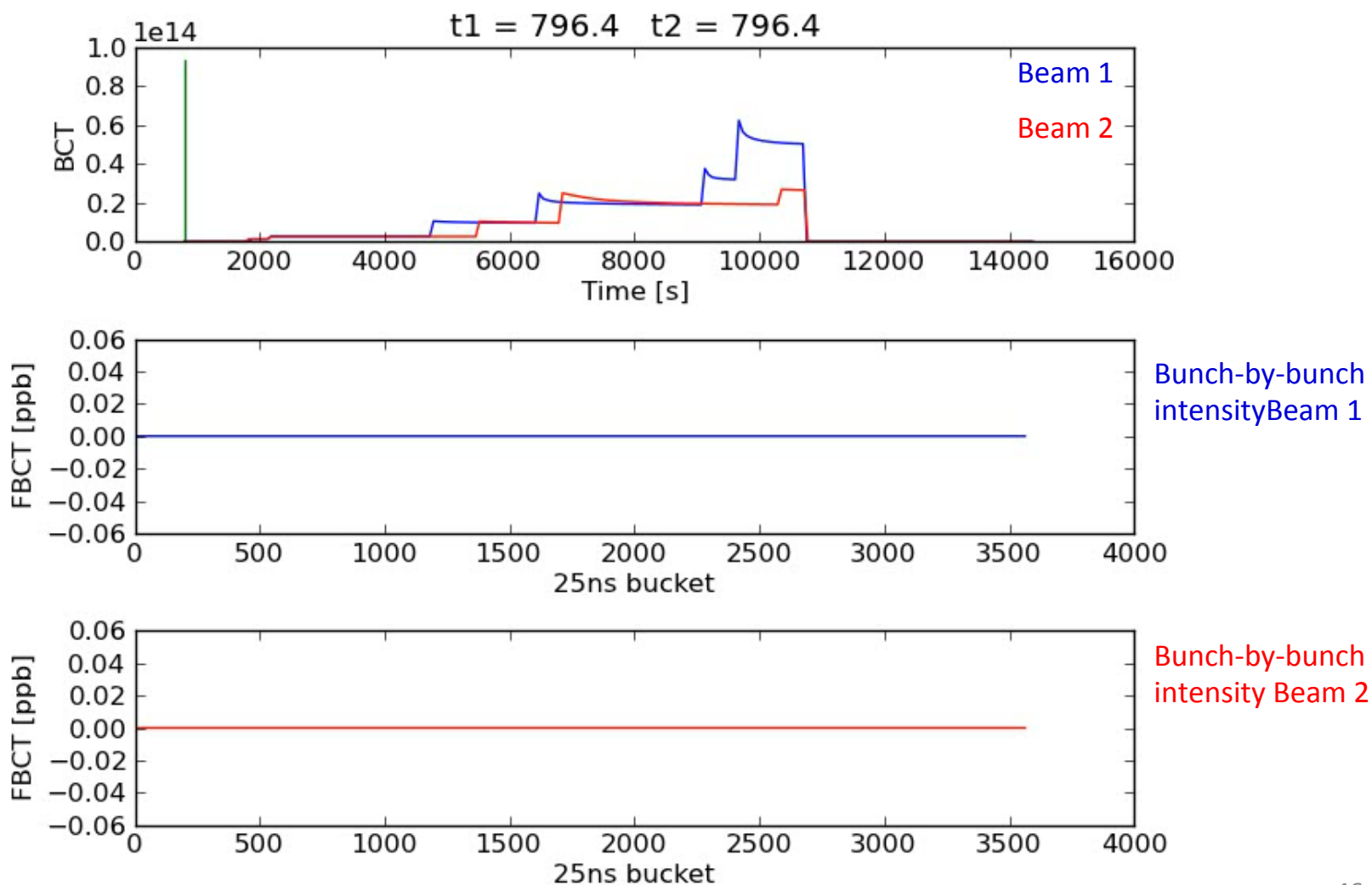

Electron cloud in LHC

injection tests of 25 ns beams (July 2012)

- Up to fourfold emittance growth for both beams
- Affecting last bunches of batches
- Affecting especially the vertical plane

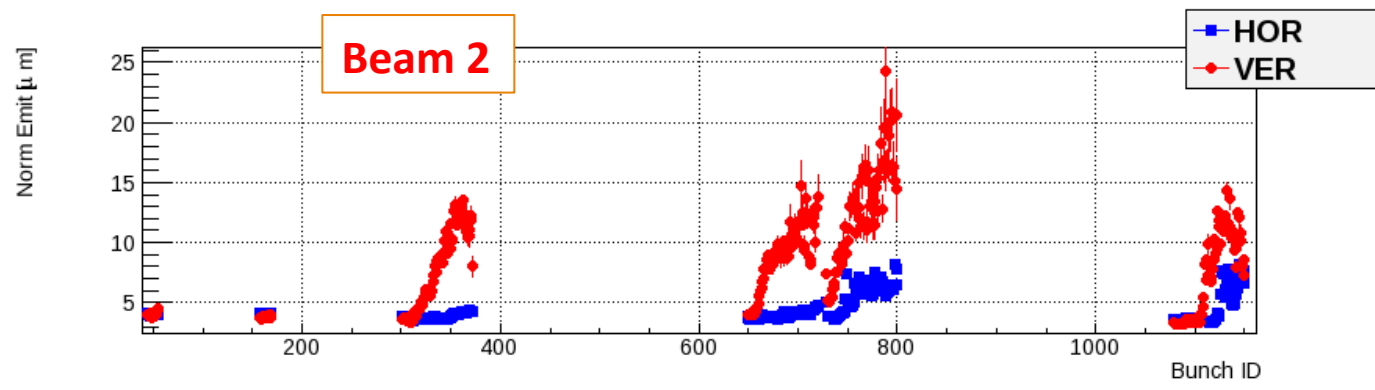
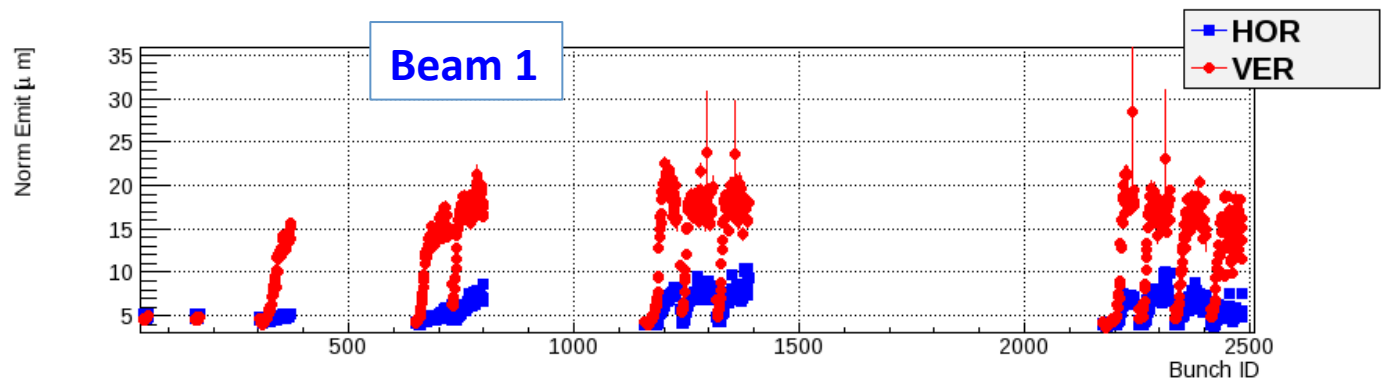

Electron cloud in LHC

Heat load in arcs during scrubbing run (December 2012)

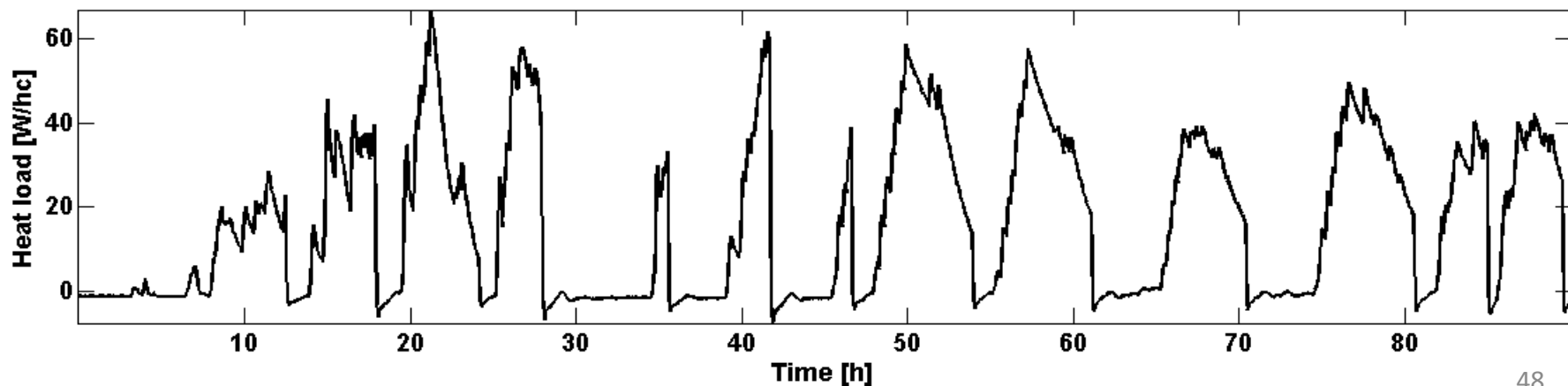
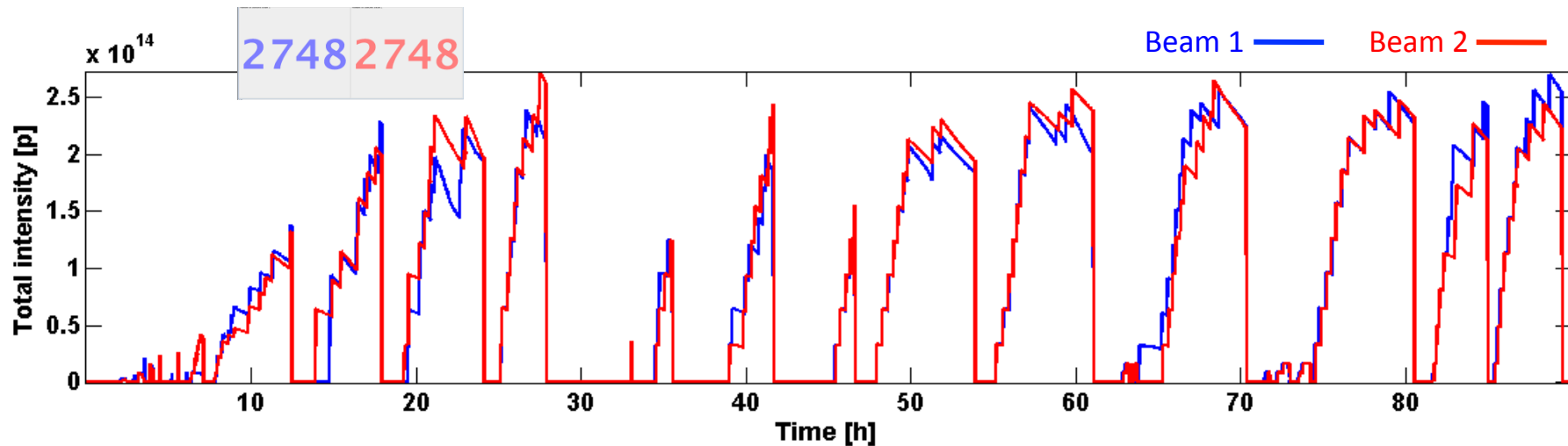

Electron cloud in LHC

Heat load in arcs during scrubbing run (December 2012)

Clearly electron cloud !

fill 3407 started on Mon, 10 Dec 2012 03:05:00

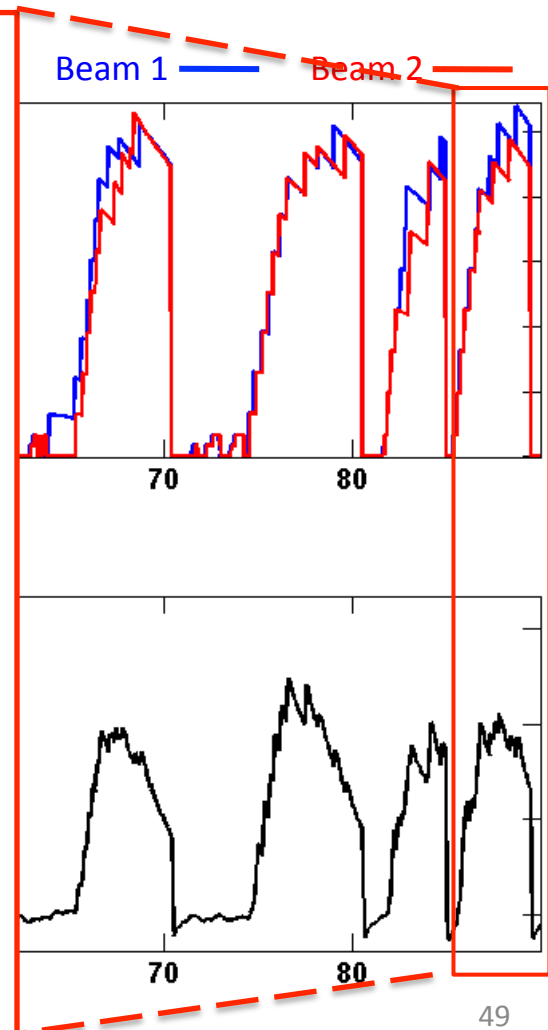
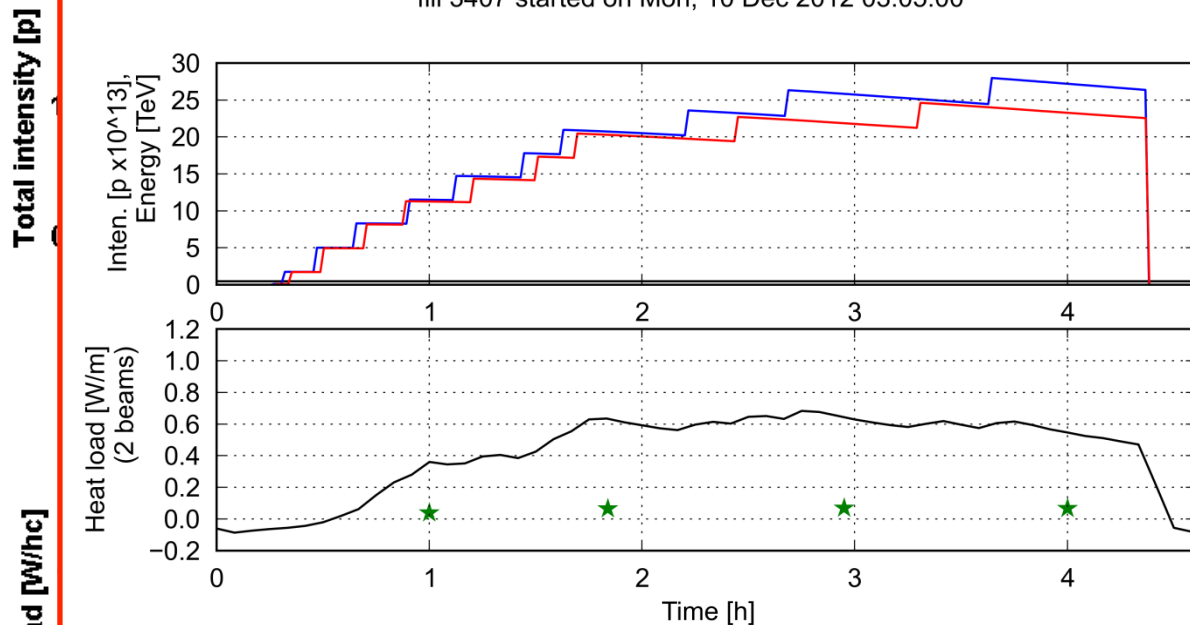

- Heat load measurement from cryogenics
- ★ Estimation (impedance + synchrotron rad.)

Electron cloud in LHC

Heat load in arcs during scrubbing run (December 2012)

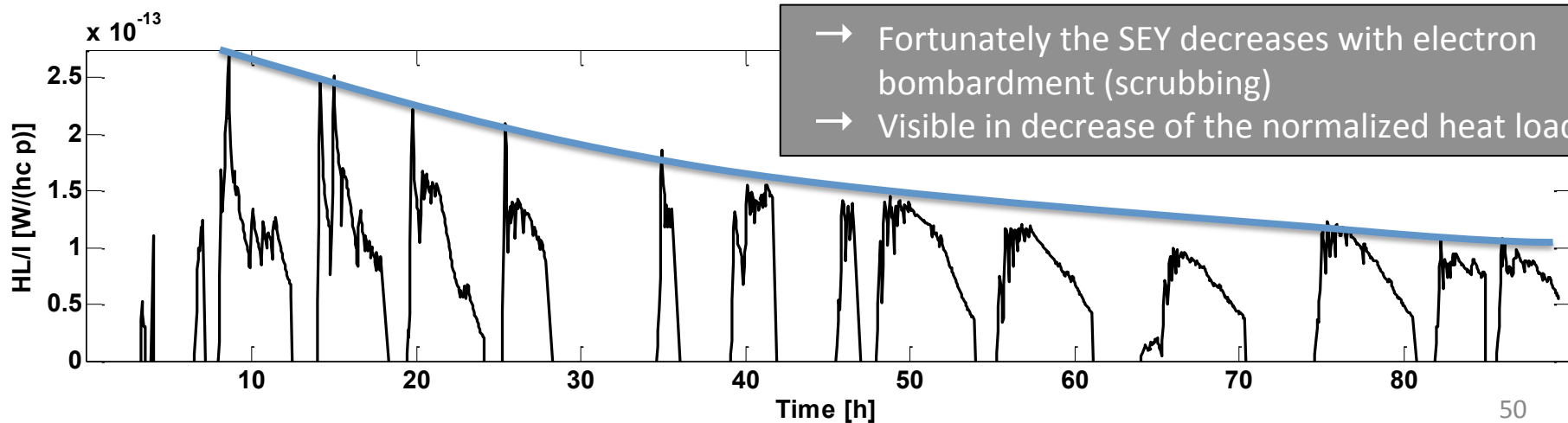
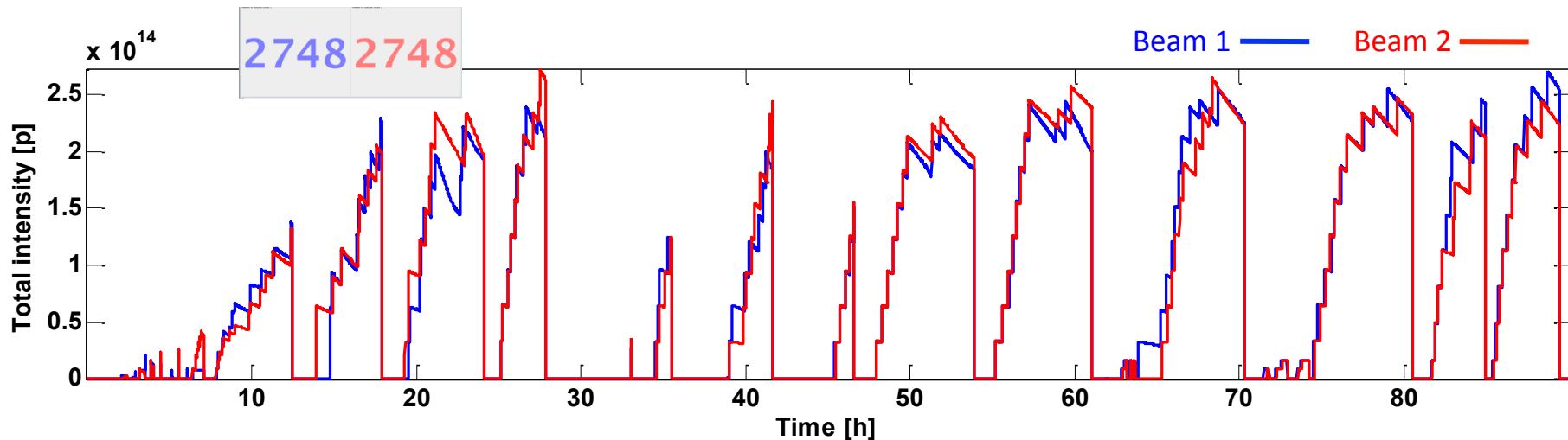

Electron cloud mitigation

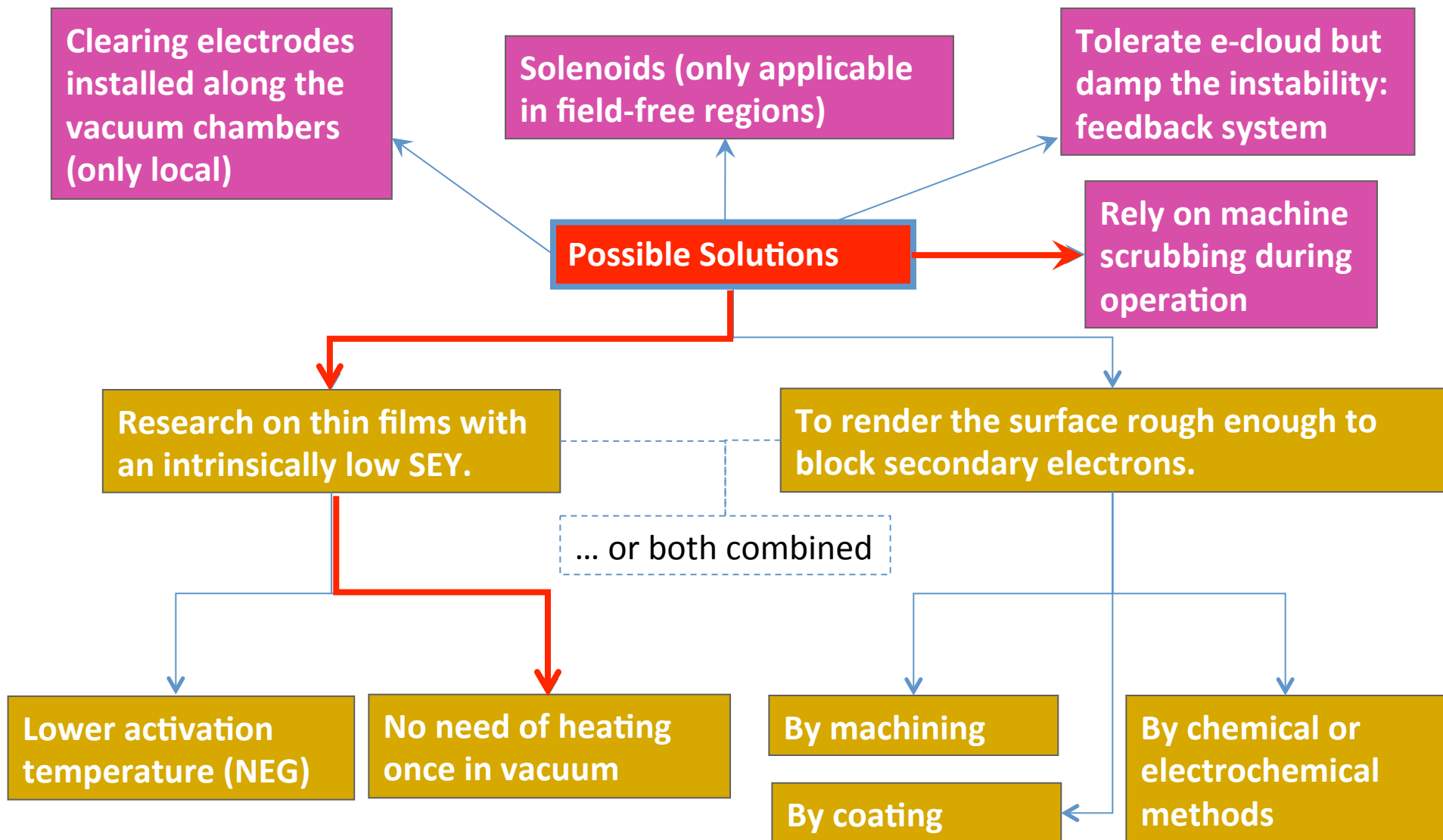

To summarize and conclude

- **Collective effects are a threat to the preservation of the beam quality in an accelerator and usually define a performance limitation.** For ex.
 - Space charge → emittance growth, poor lifetime
 - Impedance → instabilities, beam induced heating
 - Electron cloud → instabilities, heating, vacuum degradation
- Theoretical and numerical models are constantly under development to explain the underlying mechanisms and be able to anticipate the effects on the beam
 - Essential for identification of the problems while designing a new machine or upgrading an existing one → to steer and optimize the design!
 - Allow understanding the source of problems in running machines → to study and implement the necessary countermeasures
- The CERN accelerator rings (PSB, PS, SPS, LHC) provide a varied range of examples of these effects and of the continued efforts to explain/suppress them