

# Energy Recovery Linacs

Virtual beam power for a multitude of applications

Andreas Jankowiak  
Helmholtz-Zentrum Berlin and  
Humboldt-Universität zu Berlin



## Energy Recovery Linacs – Why and How ?

storage ring versus linac (real  $\leftrightarrow$  virtual power, equilibrium  $\leftrightarrow$  “control”)  
the ERL principle and its promises

## History

first idea, first tests, first projects

## Applications

multi-user light sources, collider, cooler, compact sources

## Challenges

electron source, beam optics, beam break up, collective effects, unwanted beam  
at the example of the Berlin Energy Recovery Linac Project bERLinPro

more details on many aspects:

<https://www.bnl.gov/erl2015/>

ERL2015, ICFA Workshop

Stony Brook University

# Storage ring ↔ linac – virtual ↔ real power

## synchrotron radiation source, collider

$$P_{\text{virtual}}[\text{W}] = E[\text{eV}] \cdot I[\text{A}]$$

$$E_{\text{stored}}[\text{J}] = E[\text{eV}] \cdot I[\text{A}] \cdot T_{\text{rev}}[\text{s}]$$

### e.g. BESSY II, 3<sup>rd</sup> generation light source

1.7 GeV, 300 mA = 510 MW virtual beam power,  
thereof ca. 90 kW synchrotron radiation power  
( and only 408 J stored energy )

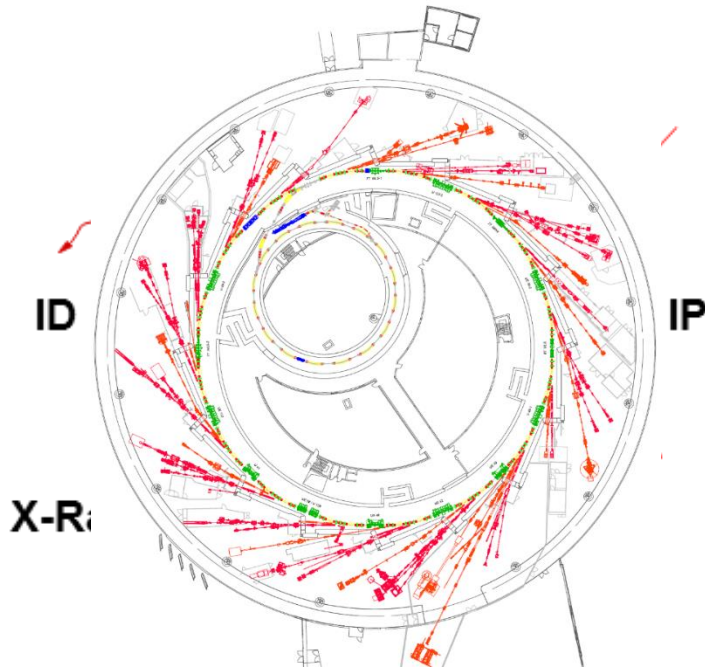

## free electron laser, collider, fixed target

$$P_{\text{real}}[\text{W}] = E[\text{eV}] \cdot I[\text{A}]$$

### e.g. European XFEL, 1 Å hard X-ray source

17.5 GeV, 0.033 mA = 580 kW real beam power,  
ca. 100 GW peak power in 100 fs, 10 x 2700 pps,  
ca. 500 W

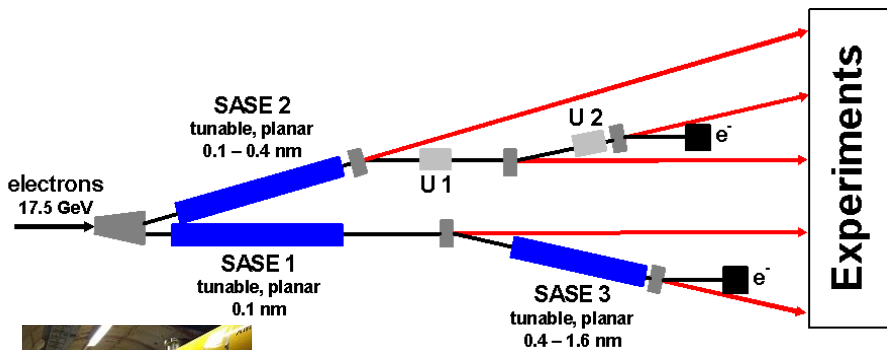

# real ↔ „virtual“ beam power

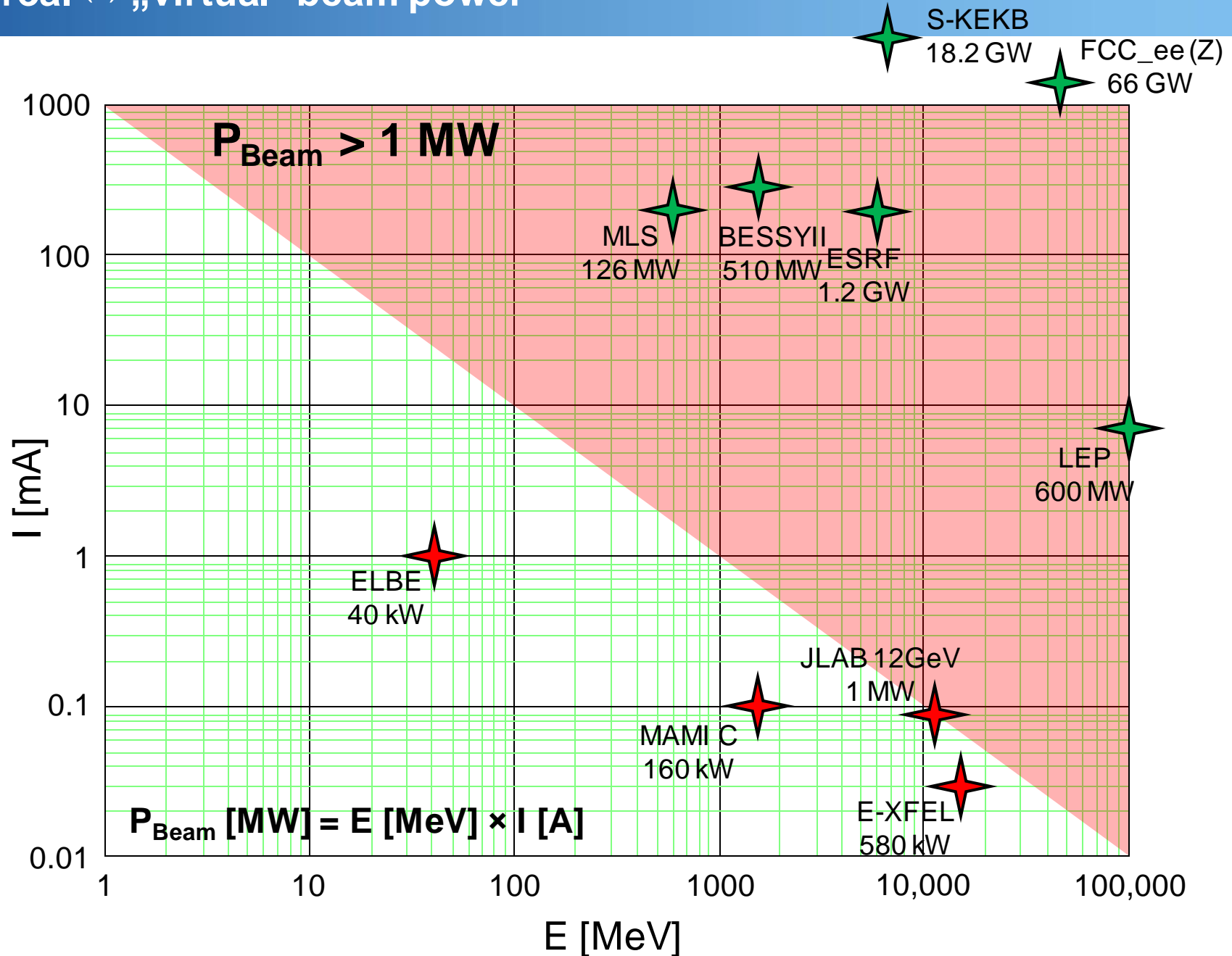

# Storage ring – governed by equilibrium processes

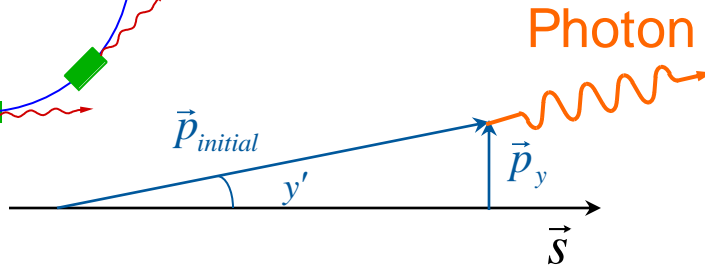
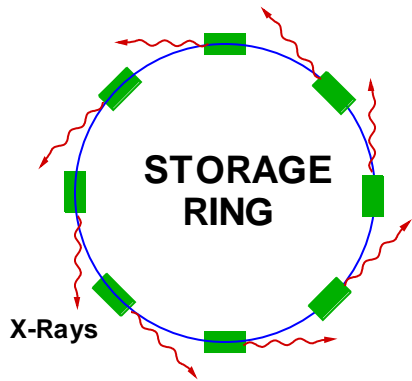

electron emits photon

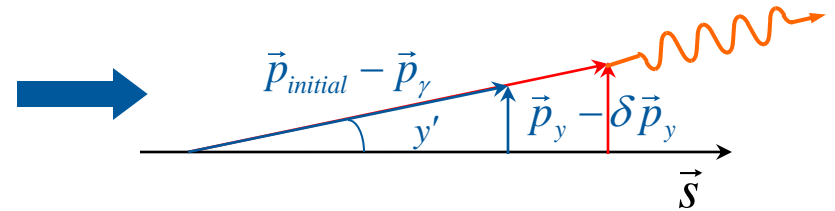

loses momentum (also transversal)

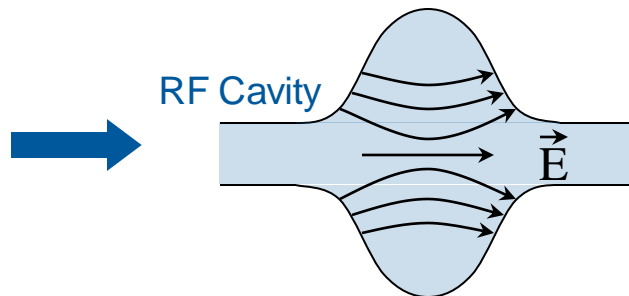

longitudinal momentum restored in acceleration cavity

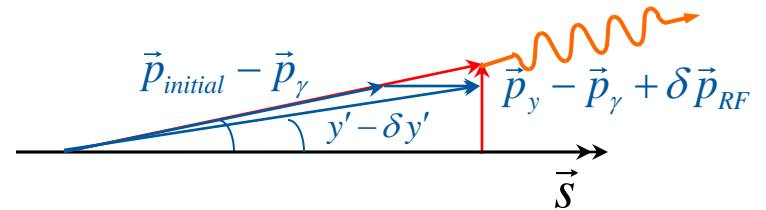

angle and displacement reduces  
→ emittance shrinks

**“damping”**

# Storage ring – governed by equilibrium processes

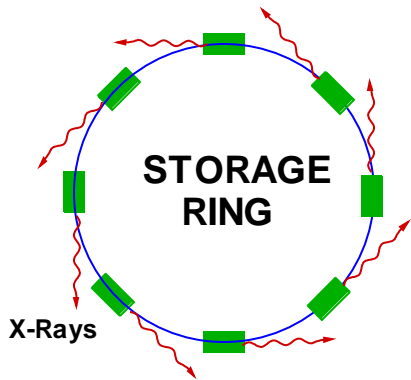

emission of photon at position with dispersion  
(e.g. in dipole, where transversal position  
is energy dependent)  
electron oscillates around reference orbit  
→ emittance increase

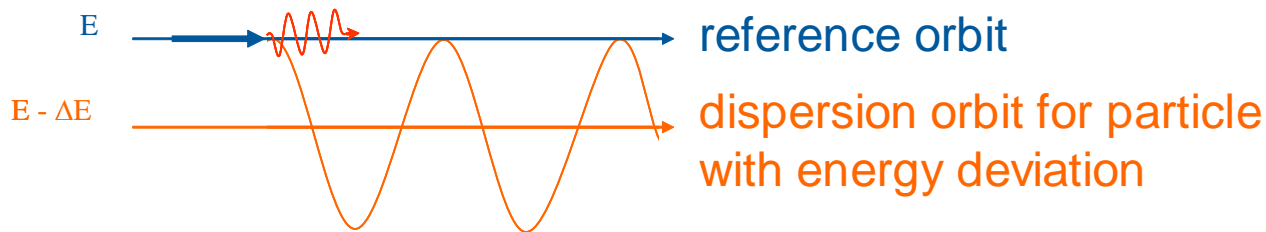

## “heating”

emittance is defined by an equilibrium between these  
two processes (damping and heating)  
typical order: some nm rad horizontal (1/100 vertical)  
similar process defined energy-spread and pulse length

# Linac – governed by adiabatic damping and “control”

## „adiabatic“ damping

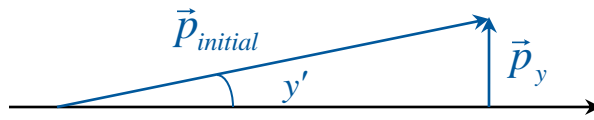
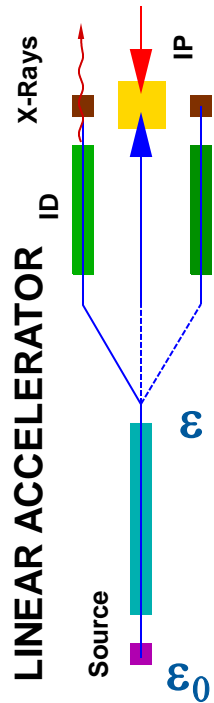

electron has transversal momentum

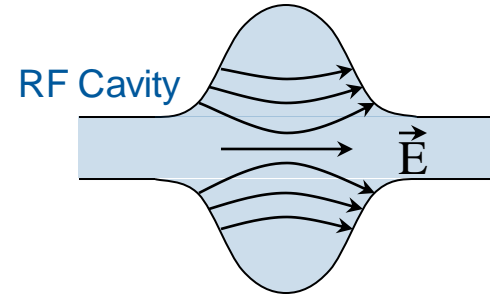

longitudinal component increases during acceleration

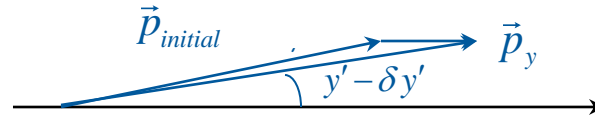

angle reduces with acceleration, emittance shrinks  $\epsilon = \frac{\epsilon_0}{\gamma}$

additional: bunch-length control by applying correlated energy chirp (off crest) and magnetic chicane with longitudinal dispersion

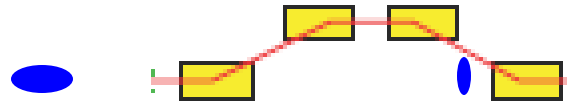

The quality of the beam is defined by the source, the rest is proper acceleration and phase space control !

# Storage ring versus Linac

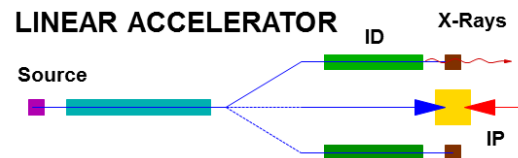
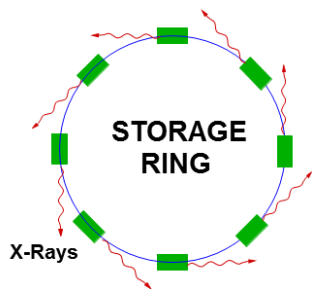

equilibrium beam dimensions

adiabatic damping + control

$$\varepsilon_x = C_\gamma \cdot \frac{\gamma^2}{J_x} \cdot \frac{\left\langle \frac{1}{R^3} H(s) \right\rangle}{\left\langle \frac{1}{R^2} \right\rangle} \sim \frac{\gamma^2}{N^3}, \varepsilon_y = \kappa \cdot \varepsilon_x$$

$$\varepsilon_{x,y} = \frac{\varepsilon_0}{\gamma}$$

$$\frac{\sigma_E}{E} \sim \frac{\gamma}{\sqrt{\rho}}$$

$$\left( \frac{\sigma_E}{E} \right)_0 \sim \frac{1}{\gamma}$$

$$\sigma_s \sim \sqrt{\frac{\alpha}{V'}} \cdot \sigma_E$$

$$\sigma_s = f(\sigma_0)$$

plus bunch manipulation

“virtual (internal) power”

real (external) power



# Beam emittance – single pass machine ↔ storage ring

**3<sup>rd</sup> generation light sources in operation (selection):**  
 ALBA (5 nm@3 GeV), SOLEIL (4 nm@2.7 GeV), DIAMOND (3 nm@3 GeV),  
 ESRF (4 nm@6 GeV), APS (3 nm@7 GeV), SPring8 (3nm@8 GeV)  
 ALS (2.2 nm@1.9 GeV), PETRAIII (1 nm@6 GeV / **0.16nm@3GeV**)

$$\varepsilon = \frac{\varepsilon_{\text{norm}}}{\gamma}$$

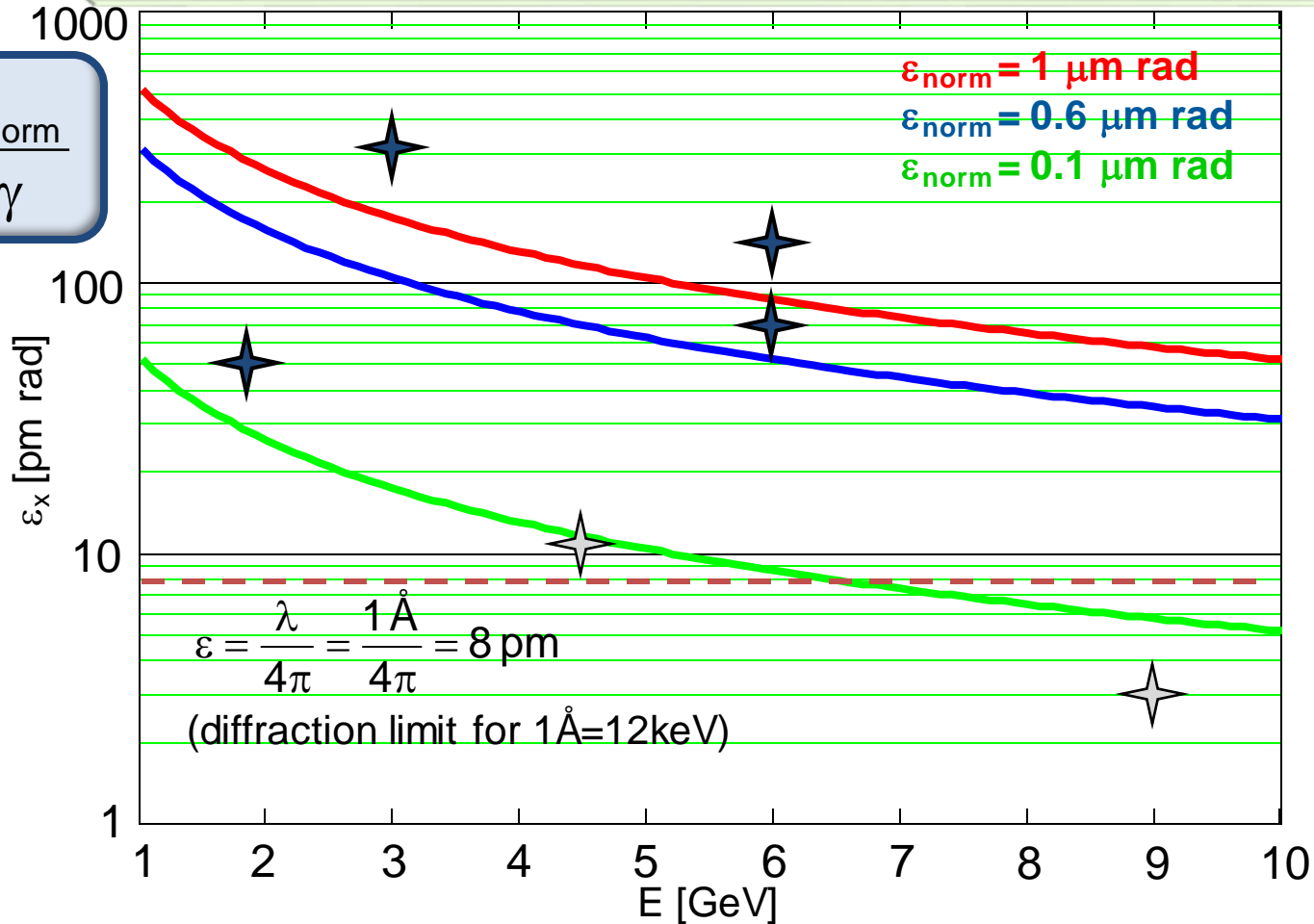

- MBA**  
 ultra low emit.  
 lattices:
- 320 pm, MAX IV (commissioning)
  - 147 pm, ESRF II (2020 back in op.)
  - 65 pm, APS (design phase)
  - ~50 pm, ALS-U (design phase)
  - 11 pm, PEPX (design study)
  - 3 pm, tUSR (design study)

**Storage rings: low emittance goes hand in hand with necessity to operate with long bunches (50 ps – 200 ps) to reduce Touschek and IBS scattering!**

# Energy Recovery Linacs – The idea

- high average („virtual“) beam power (up to A, many GeV)
- many user stations
- beam parameter defined by equilibrium
- typical long bunches (20 ps – 200 ps)

- outstanding beam parameter
- single pass experiments
- high flexibility, short bunches (~ 10 fs)
- low number of user stations
- limited average beam power ( $\ll$  mA)

e.g. ESRF:  
6 GeV, 200 mA  
**1.2 GW**  
virtual power,  
stored energy  
only 3380 J

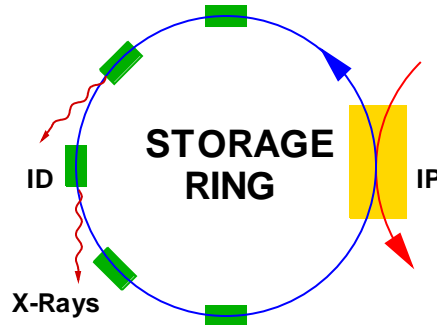

# Energy Recovery Linacs – The idea

- high average („virtual“) beam power (up to A, many GeV)
- many user stations
- beam parameter defined by equilibrium
- typical long bunches (20 ps – 200 ps)

- outstanding beam parameter
- single pass experiments
- high flexibility
- low number of user stations
- limited average beam power ( $\ll$  mA)

e.g. ESRF:  
6 GeV, 200 mA  
**1.2 GW**  
virtual power,  
stored energy  
only 3380 J

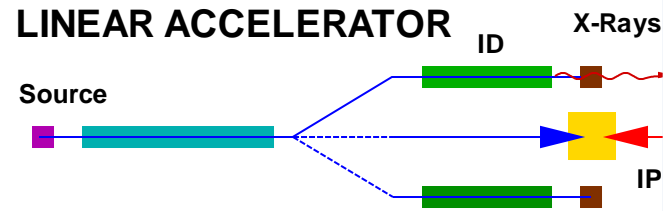
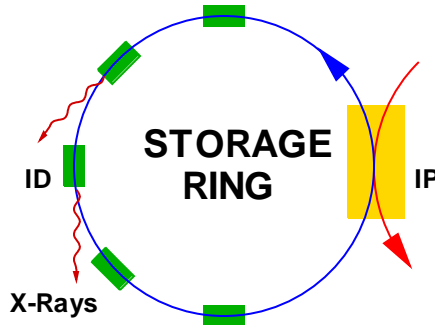

e.g. XFEL:  
17.5 GeV, 33  $\mu$ A  
“only” ~ 600 kW,  
but real power

$$\epsilon \sim \frac{1}{\gamma} \cdot \epsilon_{\text{source}}$$

**intrinsic short bunches,  
high current**

## ENERGY RECOVERY LINAC

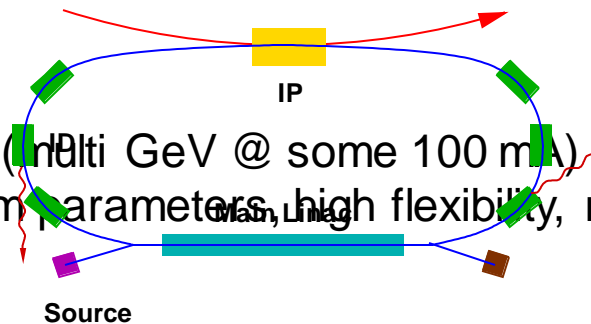

high average beam power (Multi GeV @ some 100 mA) for single pass experiments,  
excellent beam parameters, high flexibility, multi user facility

# Energy recovery (nothing spooky)

e.g. „electron cooler“ for ion beams, first devices in the 70ies

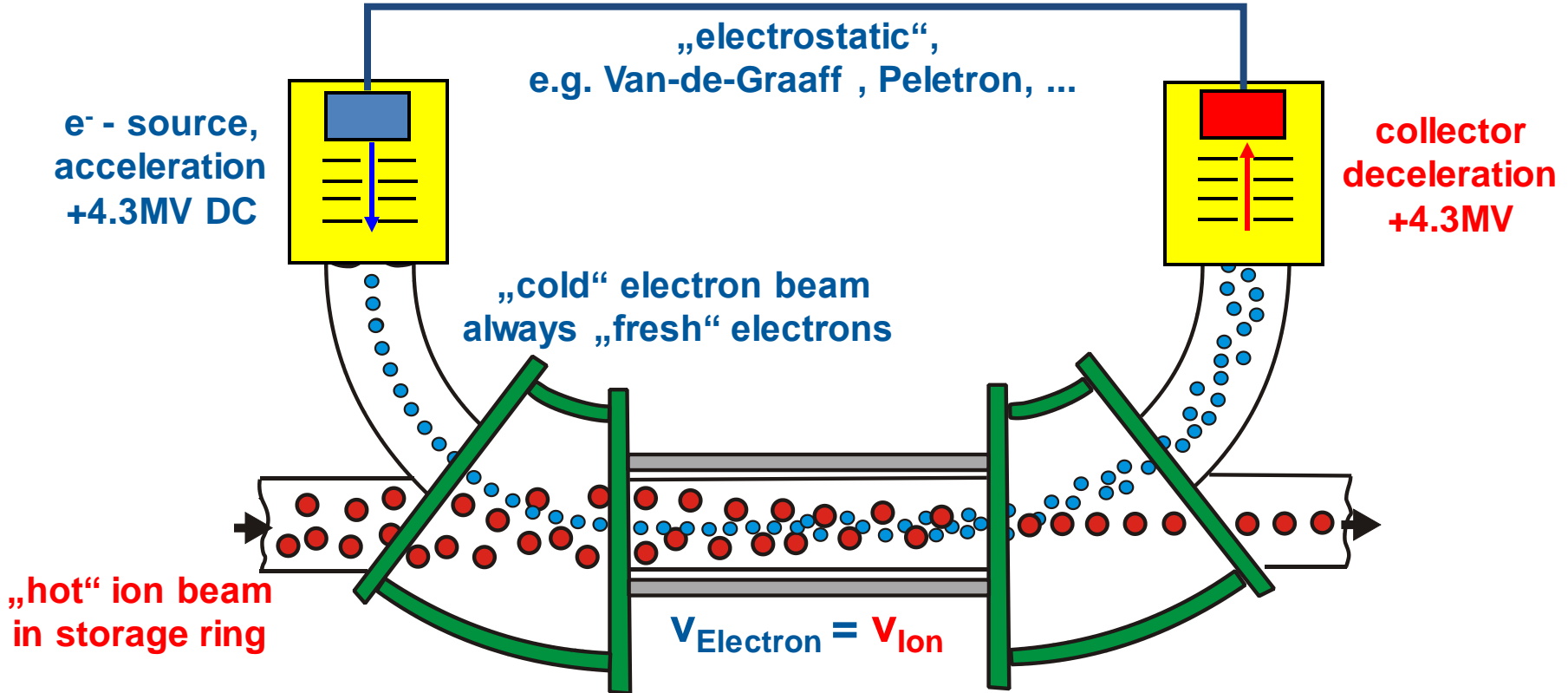

e.g. FermiLab recycler ring (Tevatron)

anti protons:	$E = 9 \text{ GeV}$	$\rightarrow \beta = 0.994$
electrons:	$E = 4.9 \text{ MeV}$	$\rightarrow U_{\text{Cooler}} = 4.39 \text{ MV}$
	$I = 0.5 \text{ A (DC)}$	$\rightarrow P = 2.2 \text{ MW}$

„virtual“

# Energy recovery in RF-fields – braking the DC limit

## RF linear accelerator

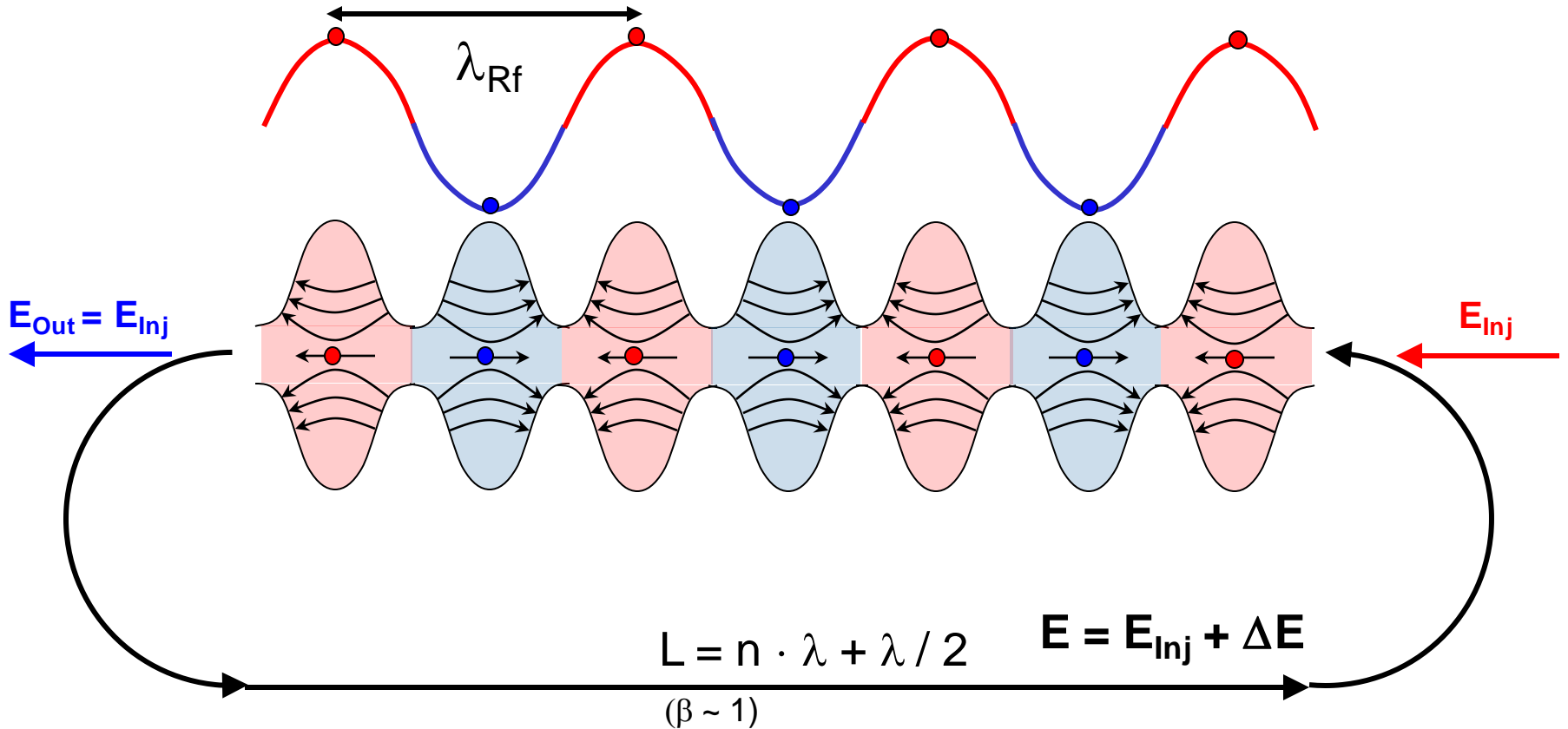

**Energy supply = acceleration**

→ „loss free“ energy storage (in the beam)

→ Energy recovery = deceleration

# The Energy Recovery Linac Principle

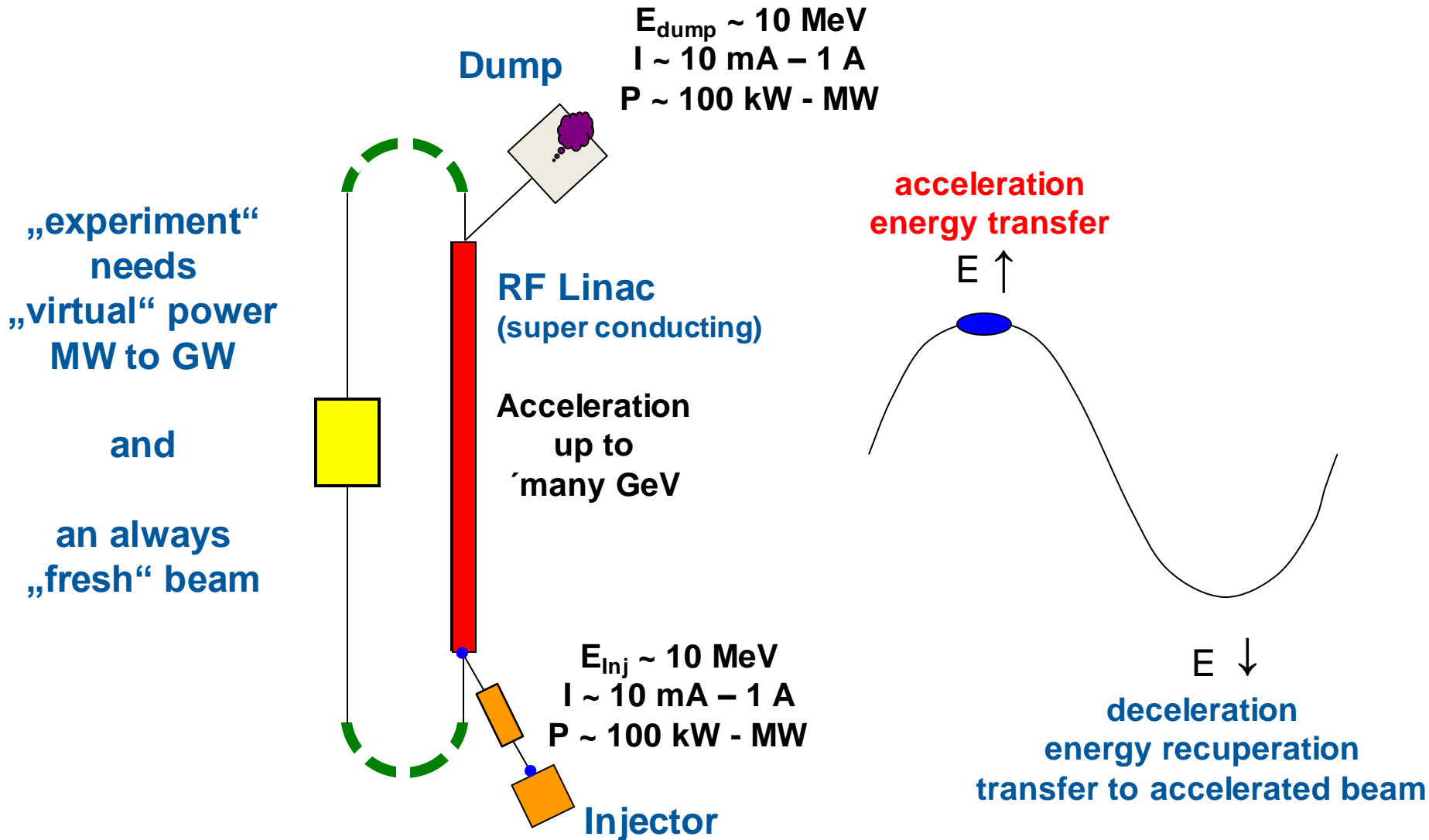

# ERLs are in favor of superconducting RF

## normal conducting (Cu) RF

(typical S/C-Band, ~2 – 6 GHz)

$\Delta E \sim 1 \text{ MV/m} / P_{\text{RF}} \sim 15 \text{ kW/m (CW)}$

(in short structures 210 kW/m reached = 3.8 MV/m)

pulsed operation allows ~ 50 MV/m, but duty cycle reduced by  $\min 1/50^2 = 0.4 \text{ ‰}$

**cw high current operation hampered by limited HOM damping capabilities**

(efficiency needs long structures with many cells, apertures typical only 10-20mm)



## super conducting (Nb) RF

(L-Band, ~ 1 – 2 GHz)

$\Delta E \sim 20 \text{ MV/m} / P_{\text{RF}} \sim 20 \text{ W/m (CW)}$

(JLAB upgrade: 19.2 MV/m)

**large apertures (70mm+) and low number of cells allows efficient HOM damping**



**SC RF allows to built an ERL “compact” (high gradient)  
for high current cw operation (large apertures, strong HOM damping)**

**Wall plug power consumption shifts from RF to Cryo (2K efficiency ~ 1/1000)**

**ERL is not necessarily a “green machine”**

## First idea: M. Tigner, Nuovo Cimento 37 (1965) 1228

Beam energy (GeV)	0.5	3
Length (m)	47	275
Beam current (A)	0.120	0.120
Luminosity ( $\text{cm}^{-2} \text{s}^{-1}$ )	$3 \cdot 10^{30}$	$3 \cdot 10^{30}$
RF power to establish accelerating field in absence of beam (kW), (1000 MHz operation)	.55	3.3
Refrigerator power (MW)	0.92	5.5
Synchrotron radiation loss in magnets (kW)	—	14 (30 m bending radius)

g-Beam Experiments (\*).

rsity - Ithaca, N. Y.

65)

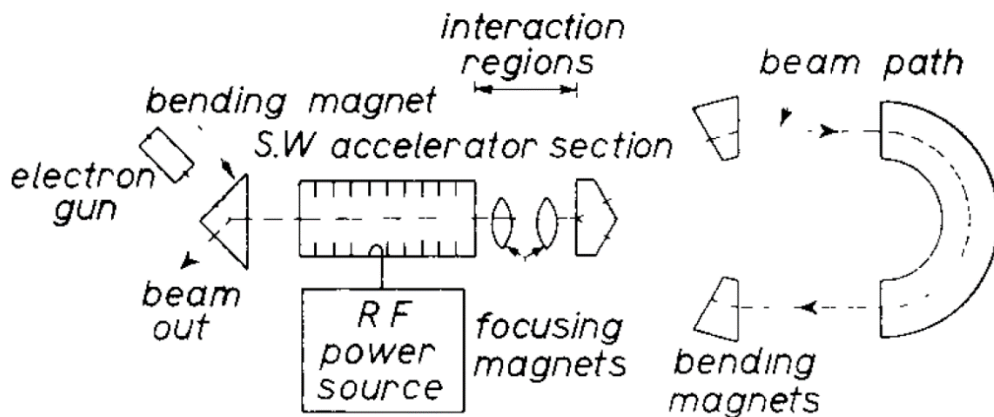

- stability issues (charge) solved
- one linac only

Maybe first realisation (1977, without taking attention to it): Reflexotron (two pass linac) for medical application (Chalk River, Canada)

S.O. Schreiber, IEEE NS-22 (1975) (3) 1060-1064



# History – First demonstration

## First demonstration:

Stanford SCA/FEL, 07/1987 (sc-FEL driver)

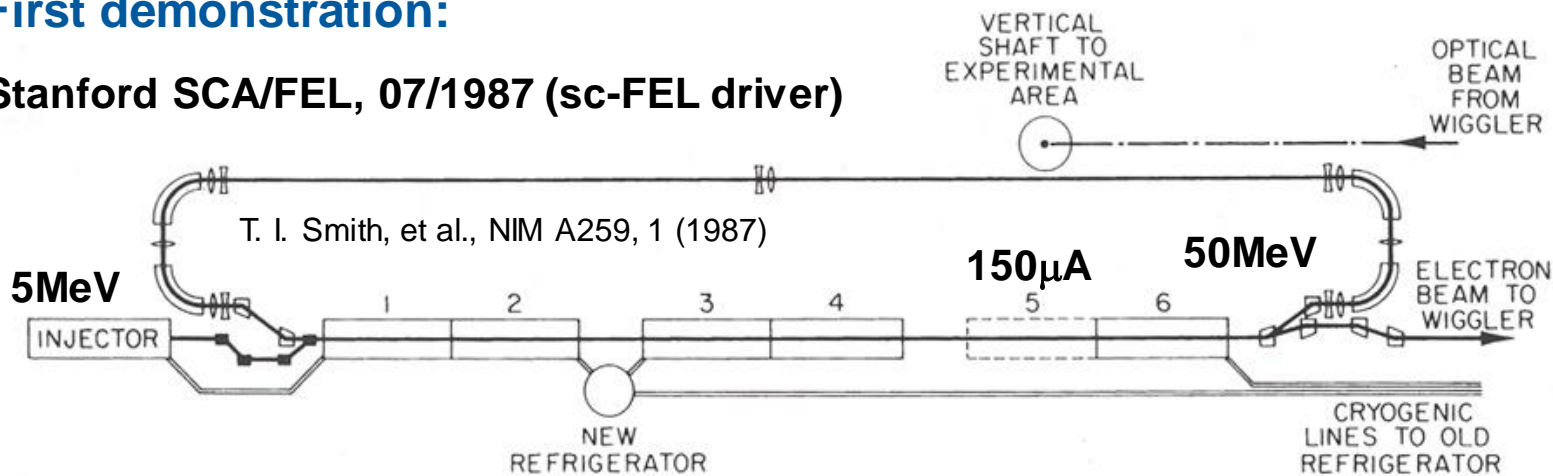

MIT Bates Recirculated Linac (2.857GHz, nc, pulsed), 1985

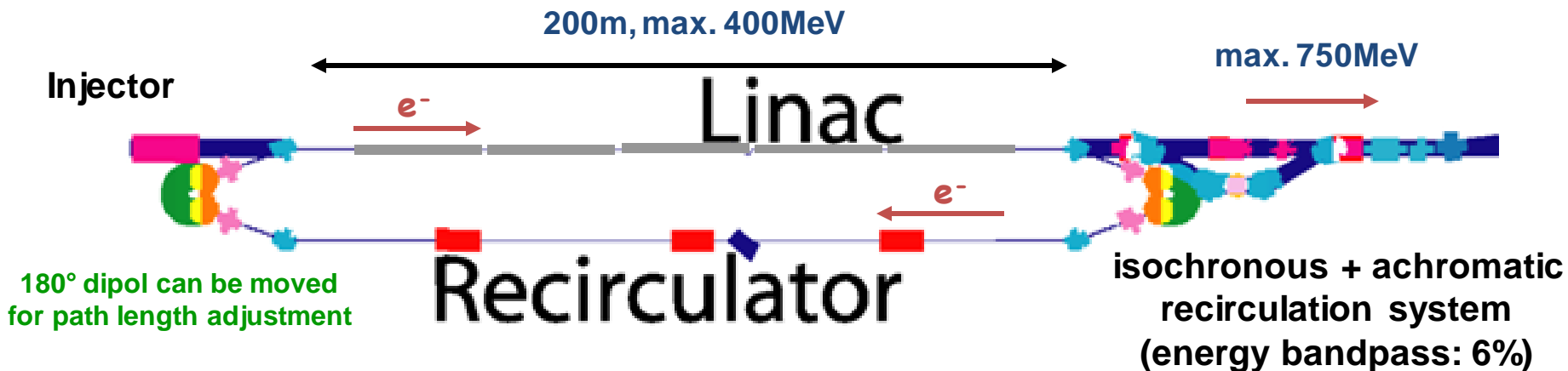

J.B. Flanz et al., IEEE Trans. Nucl. Sci., NS-32, No.5, p.3213 (1985)

# First facilities – JLAB FEL

G.R. Neil, et al., Nucl. Instr. & Methods **A557** (2006) 9.

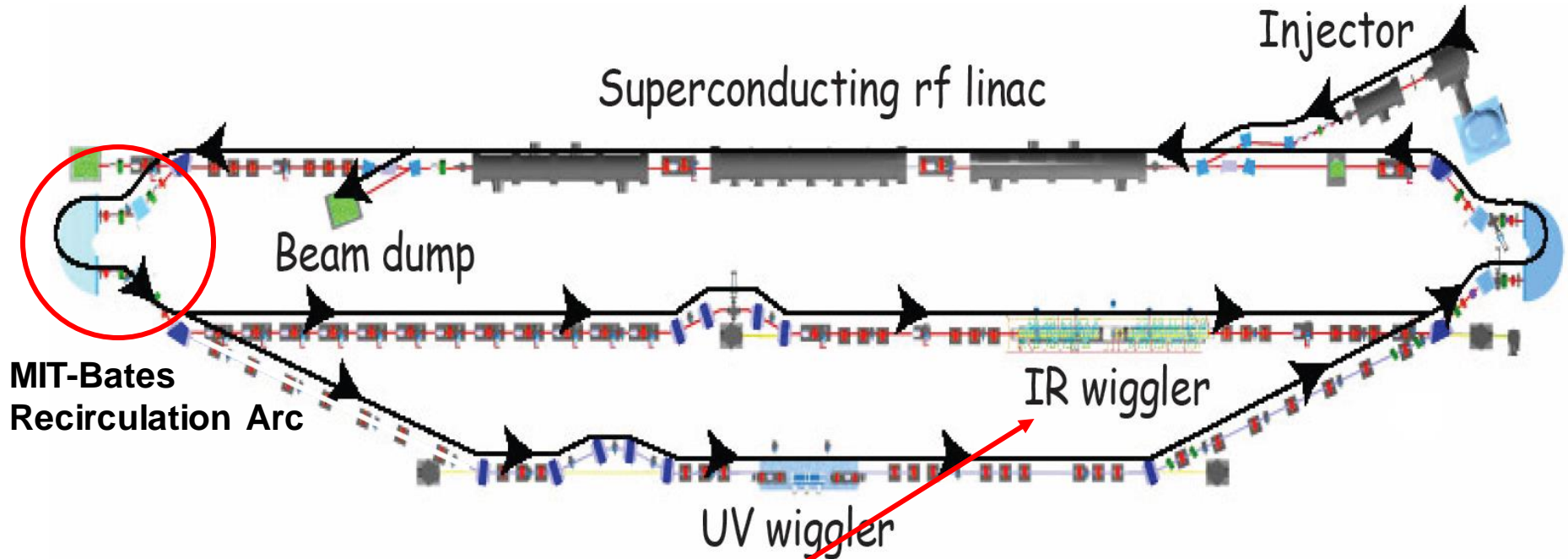

**up to 14 kW cw laser power  
@ 1.6  $\mu\text{m}$  wavelength**

**Parameter achieved:**  
Energy: 160 MeV  
Current: 9.1 mA  
(135 pC @ 75 MHz)  
beam power: 1.5 MW

emittance (norm.): 7  $\mu\text{m}$   
min. pulse length: 150 fs

# Overview on projects and facilities

**First idea:**  
M. Tigner (1965)

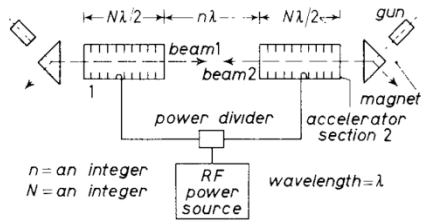

1960

1980

2000

2020

**BINP FEL (2004):**  
**First multi-**  
**turn**  
**ERL**

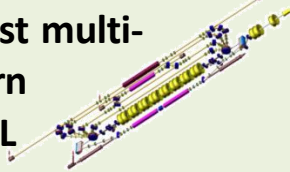

**JAERI FEL (2002):**  
17 MeV, 5 mA

**Cornell University**  
**Injector Teststand**

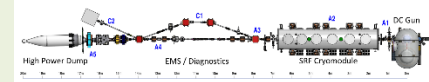

**FFAG**  
**ERL**  
(with BNL)

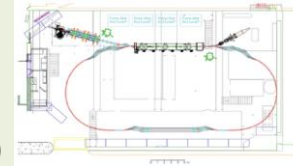

**BNL R&D ERL**  
**Beijing ERL-FEL**



ALICE, Daresbury

**First energy recovery:**  
Stanford SCA/FEL (1987)

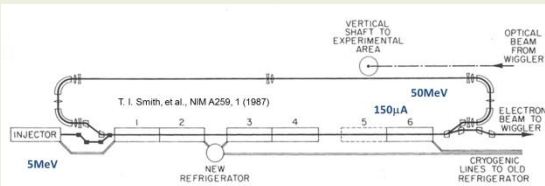

**JLAB-FEL: Demo-FEL (1999)**  
**& FEL Upgrade (2004)**

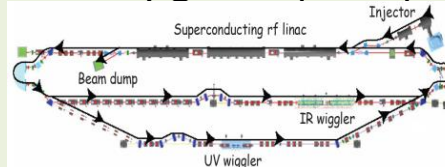

**KEK cERL (2014):**  
recirc. & energy recovery



# ERL as next Generation Multi-GeV, Multi-User SR-Source

**Combines the two worlds of storage rings and linacs**

- with energy recovery: some 100mA @ many GeV possible
- always “fresh” electrons (no equilibrium)
  - small emittanz ( $\sim 0.1 \mu\text{m rad norm.} = 10 \text{ pm rad@6GeV}$ )
  - high brilliance (x 100 – 1000 compared to SR)
  - short pulses (ps down to 10 – 100 fs)
- free choice of polarisation
- 100% coherence up to hard X-rays
- real multi-user operation at many beam lines
- tailored optics at each ID

+

**Flexible modes of operation (high brilliance, short pulse, different pulse patterns)  
adaptable to user requirements!**

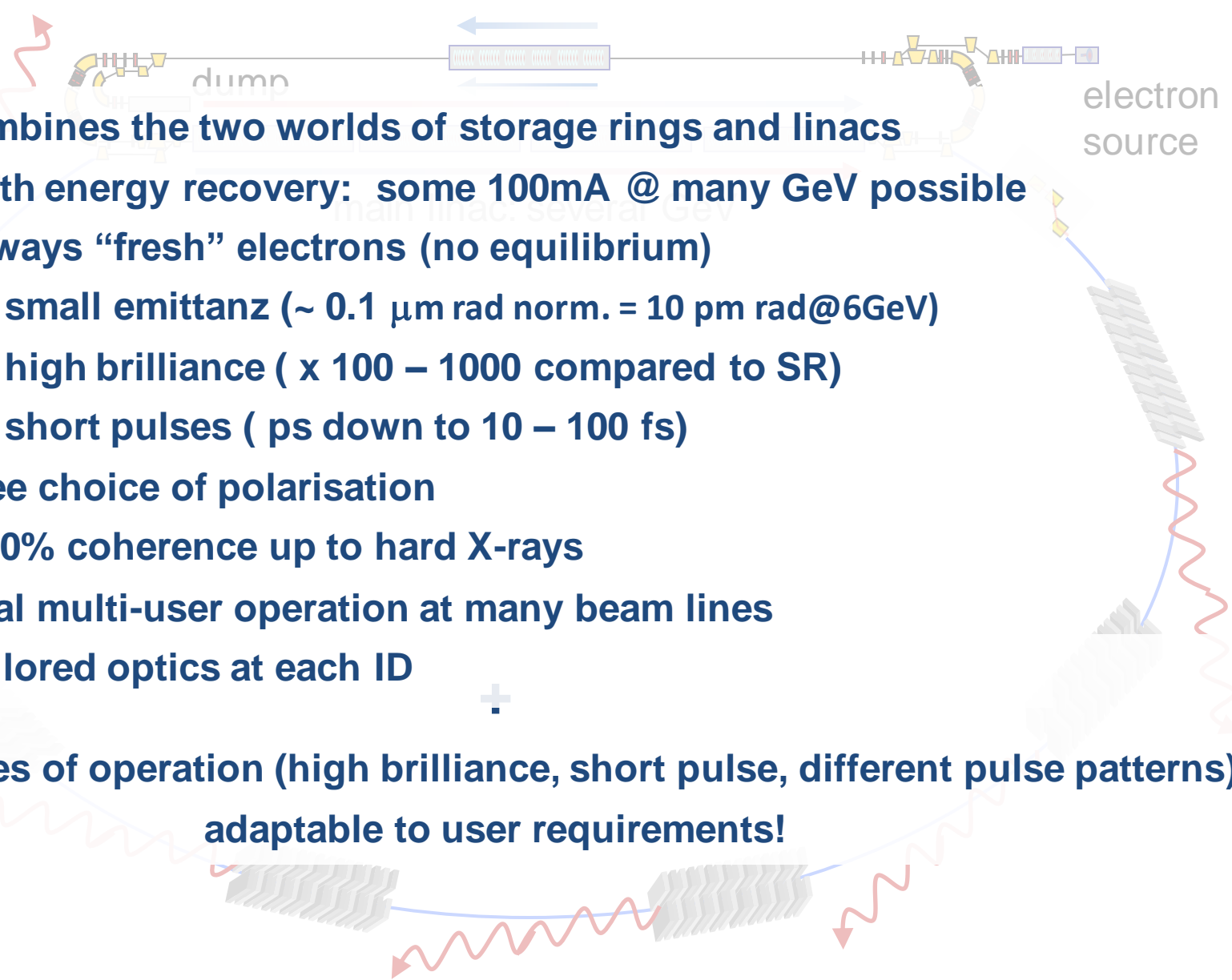

## Cornell ERL

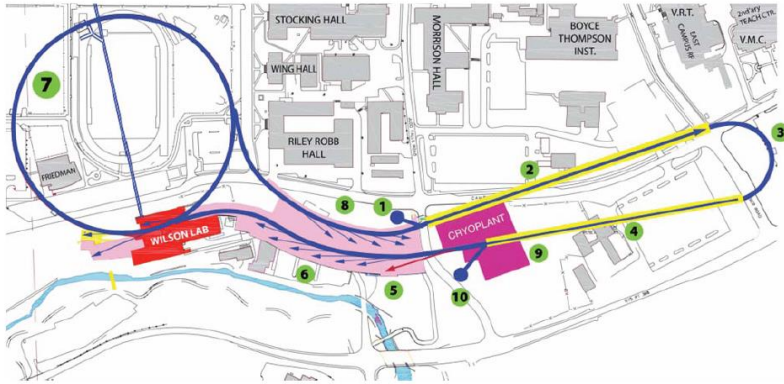

**5 GeV, 100mA,  $\epsilon = 8$  pm rad**

( $\epsilon_{\text{norm}} = 0.08 \mu\text{m}$  (@77pC), 2ps)

## KEK ERL

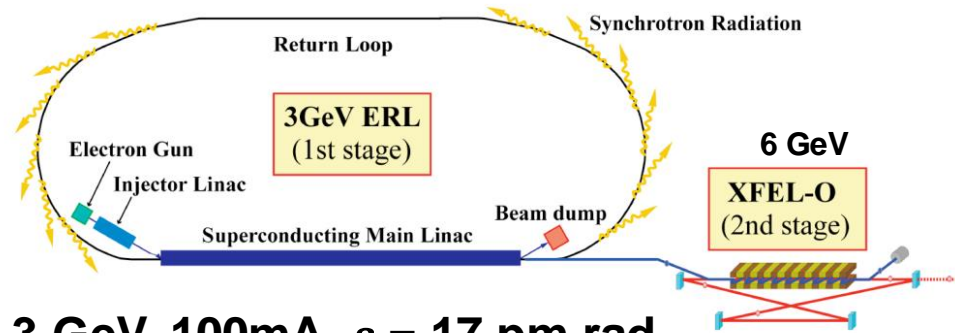

**3 GeV, 100mA,  $\epsilon = 17$  pm rad**

( $\epsilon_{\text{norm}} = 0.1 \mu\text{m}$  (@77pC), 2ps)

## Femto Science Facility (FSF)

(multi turn, split linac), A. Matveenko et al.

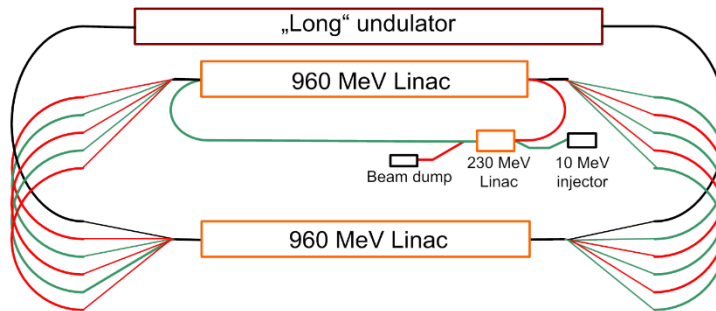

**6 GeV, 20/5 mA,  $\epsilon = 8/40$  pm rad**

( $\epsilon_{\text{norm}} = 0.1/0.5 \mu\text{m}$  (@15/4 pC), < 1 ps / 10 fs)

# ELR as electron part of Electron Ion Collider

e.g. eRHIC: addition of a ERL to RHIC / BNL = Electron Ion Collider

250 GeV polarised protons  $\leftrightarrow$  20GeV polarised electrons,  $L=10^{33-34} \text{ cm}^{-2} \text{ s}^{-1}$   
 (415 mA) (10 mA) ( $\beta^*=5\text{cm}, 6\mu\text{m}$  spot size @ IP)

## ERL compared to storage ring

- electron beam needs to pass the interaction zone only once
- disturbance of electron beam by proton beam can be up to 20x stronger
- higher number of protons with high density possible  
 → drastic increase in luminosity
- higher flexibility in interaction region design
- spin transparency (free choice to arrange spin orientation at IP)

Why ERL and not storage ring?

### Luminosity

$$L = f_{\text{coll}} \cdot \frac{n_{\text{Ion}} \cdot n_e}{4 \cdot \pi \cdot \epsilon \cdot \beta} \cdot F_{\text{HGR}}$$

Limit: beam-beam parameter electrons (!)

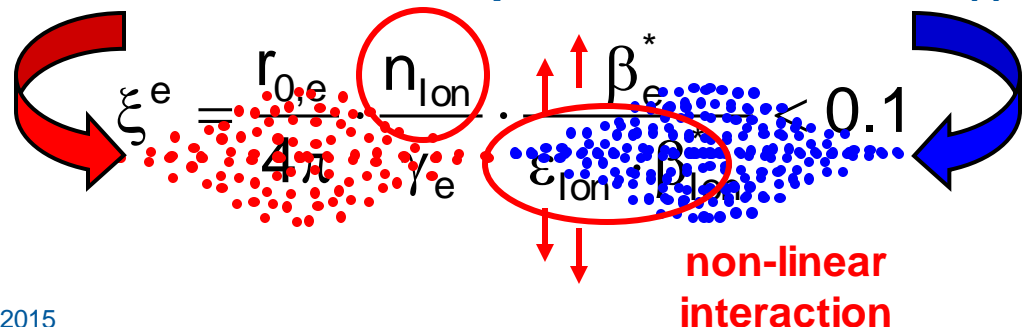



# ELR as electron part of Electron Ion Collider

60 GeV (e) x 7 TeV (p)

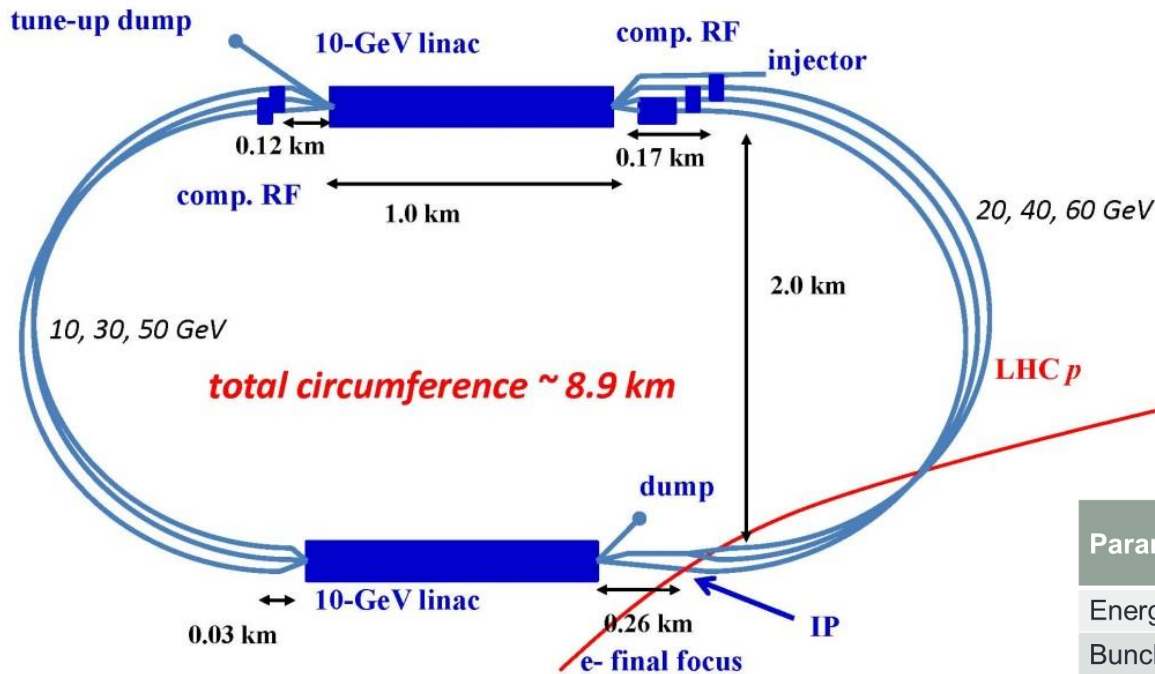

Parameters	LHeC	
	e	p
Energy (GeV)	60	7000
Bunch spacing (ns)	25	
Intensity, $10^{11}$	0.01	1.7
Current (mA)	6.4	860
rms norm. emit. (mm-mrad)	50	3.75
$\beta_{x/y}^*$ (cm)	12	10
rms bunch length (cm)	0.06	7.6
IP rms spot size ( $\mu\text{m}$ )	7.2	
Beam-beam parameter	0.0001	
Disruption parameter	6	
Polarization, %	90	None
Luminosity, $10^{33}\text{cm}^{-2}\text{s}^{-1}$	1.3	

# ELR as electron cooler



e.g. RHIC  
Cooling of 100GeV/u Au

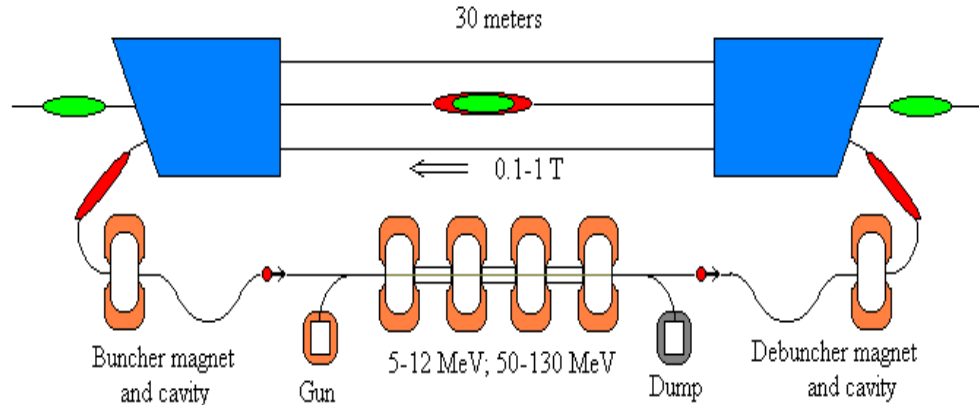

## Efficient cooling needs

- $\gamma_{ion} = \gamma_{electron}$ , e.g. 100 GeV protons needs 54.5 MeV electrons
- low emittance of electron beam ( $\epsilon_{norm} \sim \mu\text{m rad}$ )
- low energy spread of electron beam ( $\delta_{E,rel} \sim 0.05\%$ )
- high electron beam current

54.5 MV and A class currents not feasible with electrostatic accelerators

## ERL cooler needs overlap of (many “short”) electron bunches with (“long”) ion bunches

(LEReC Phase-I project@BNL, up to 2 MeV, gun2dump approved)

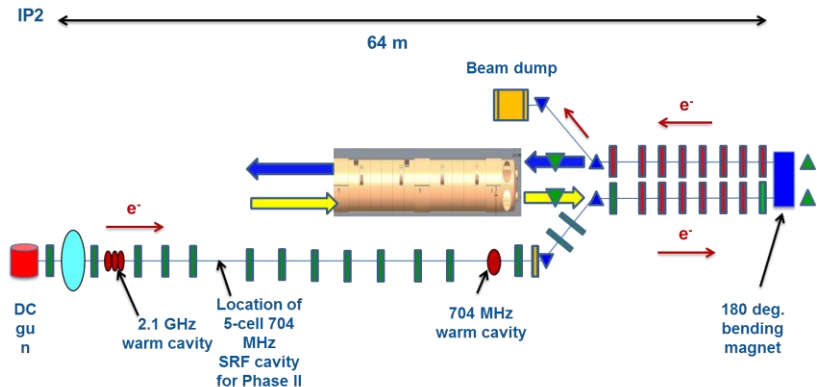

for ultra high ion energies  
**Coherent Electron Cooling**  
 (“stochastic cooling”)

- ion beam imprints modulation on electron beam
- modulation on electron beam amplified by FEL
- electron beam acts back on ion beam



# Compact ERL for high luminosity, low energy internal targets

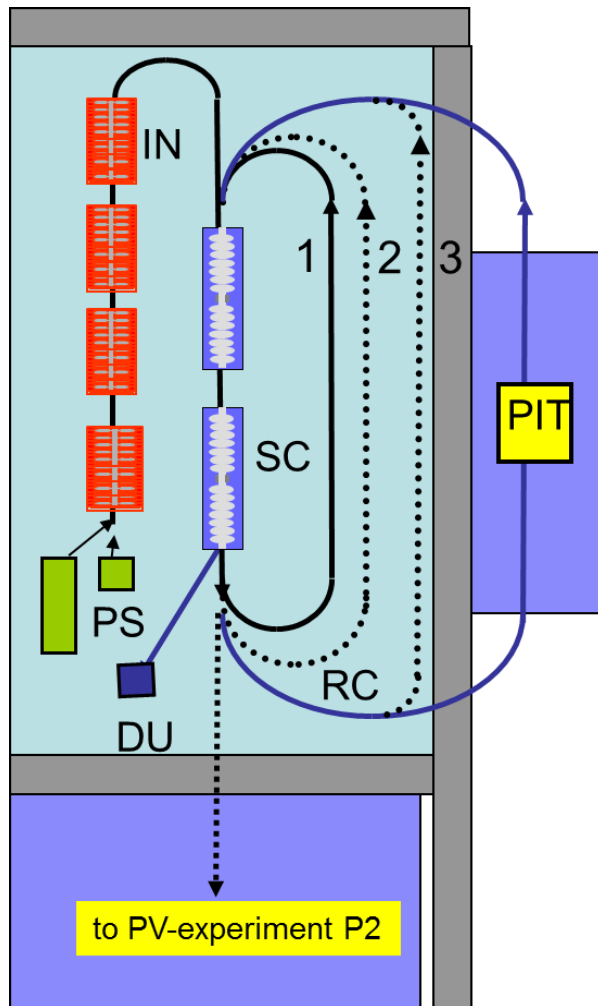

## MESA @ Mainz University

Multi turn ERL for

1) External beams for precision measurements  
(weak mixing angle)

$E=155 \text{ MeV}$  @  $150 \mu\text{A}$ , polarized  $e^-$ ,  $L=10^{39} \text{ cm}^{-2} \text{ s}^{-1}$

2) Pseudo Internal Target (PIT) experiments in  
Energy Recovery mode  
(dark photon search)

$E=105 \text{ MeV}$  @  $10 \text{ mA}$ ,  $L=10^{35} \text{ cm}^{-2} \text{ s}^{-1}$

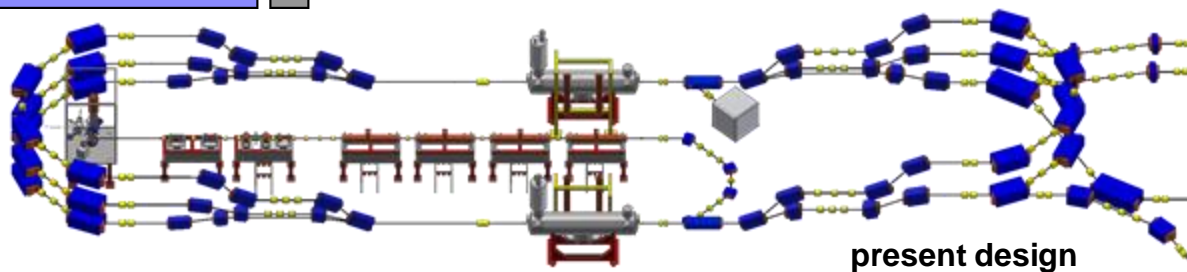

Experiments →

present design  
(e.g. ERL2015)

## **Next generation multi-user light source**

(diffraction limited, short pulses, ID tailored beam parameters)

## **High energy electron cooling of bunched proton/ion beams**

(Energy  $\sim 100$  MeV + high current  $\rightarrow$  rules out VdG or SR)

## **Ultra high luminosity electron – ion collider (EIC, LHeC)**

(overcoming beam-beam effect electron ring)

## **Compact radiation sources**

(FEL, Compton sources,  
next generation lithography)

**and more ...**

## Electron source:

high current, low emittance (100 mA – A cw with  $\varepsilon_{\text{norm}} < \mu\text{m rad}$ ) not yet demonstrated  
**(big step forward: Cornell's 80 mA)**

## Injector/Booster:

100 mA @ 5 – 15 MeV = 500 – 1500 kW beam loading (coupler, HOM damper, beam dump)

## Main-Linac:

100 mA recirculating beam → beam break up (BBU), higher order modes (HOM),  
highest cw-gradients (>15 MV/m) with quality factor  $> 10^{10}$  → reduce cryo costs

## Beam dynamics / optics:

recirculation, flexible optics, bunch compression schemes = flexibility

## Control of beam loss

unwanted beam = dark current from cathode, gun, cavities due to field emission, stray light laser  
beam halo, collimation schemes !?

### Storage ring:

nearly Gaussian  
~ pA losses typical  
~ 10 nA maximum

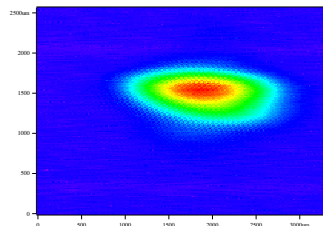

### ERL:

no dead mathematician  
~ 100  $\mu\text{A}$  losses possible

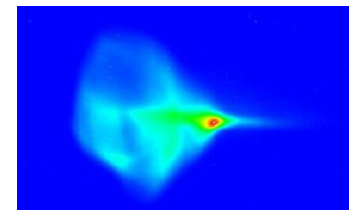

The “hummingbird”  
P. Evtushenko, JLAB

# demonstrator projects world-wide

## cERL, KEK + JAEA

35 MeV, 10 mA

- 80  $\mu$ A reached 2015 -



## ERL Injector, Cornell

5 – 15 MeV, 100 mA

- 80 mA max. demonstrated -

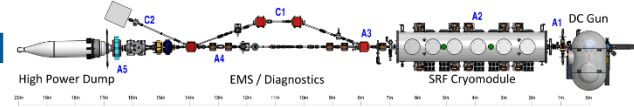

## BNL ERL

20 MeV, 30 mA

- first electrons from gun 2014 -



## FFAG ERL, Cornell/BNL

286 MeV (4 turns), 40 mA

- "white paper" issued, to be approved -

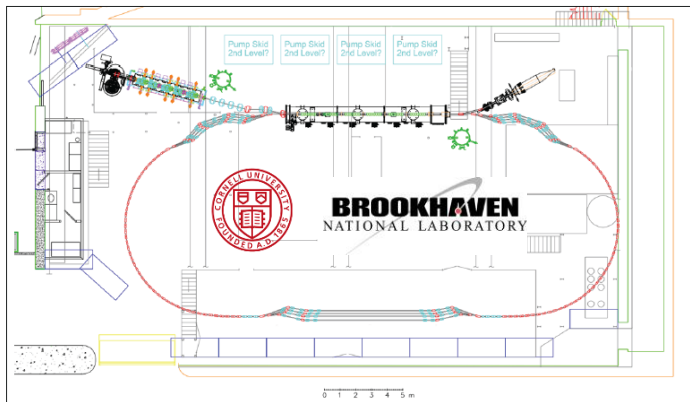

## CERN ERL

max. 900 MeV

staged

- study -



Stage 1 – 2 CMs, test installation – injector, cavities, beam dump.



Stage 2 – 2 CMs, set up for energy recovery, 2...3 passes

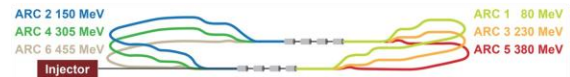

Stage 3 – 4 CMs, set up arcs for higher energies – reach up to 900 MeV



all based on DC photo electron sources

# bERLinPro – Berlin Energy Recovery Linac Project

**bERLinPro = Berlin Energy Recovery Linac Project**

**100 mA / low emittance technology demonstrator (covering key aspects of large scale ERL)**

**bERLinPro**

Helmholtz-Zentrum Berlin

**test and diagnostic line**

(5 mA@10 MeV dump,  
energy & slice diag.)

**merger  
dogleg**

**linac module**

3 x 7 cell srf cavities  
44 MeV

**beam dump**

6.5 MeV, 100 mA  
= 650 kW

**modified Cornell booster**

3 x 2 cell srf cavities  
4.5 MeV

**srf-photo gun**

1.5-2.3 MeV,  
single solenoid,

	Basic Parameter
max. beam energy	50 MeV
max. current	100 mA (77 pC/bunch)
normalized emittance	1 $\mu\text{m}$ ( <b>0.5 <math>\mu\text{m}</math></b> )
bunch length (straight)	2 ps or smaller ( <b>100 fs</b> )
rep. rate	1.3 GHz
losses	< 10 <sup>-5</sup>

**project started 2011, fully funded**

**building ready 2016**

**first electrons 2018**

**recirculation 2019**



# bERLinPro – Technological challenges I

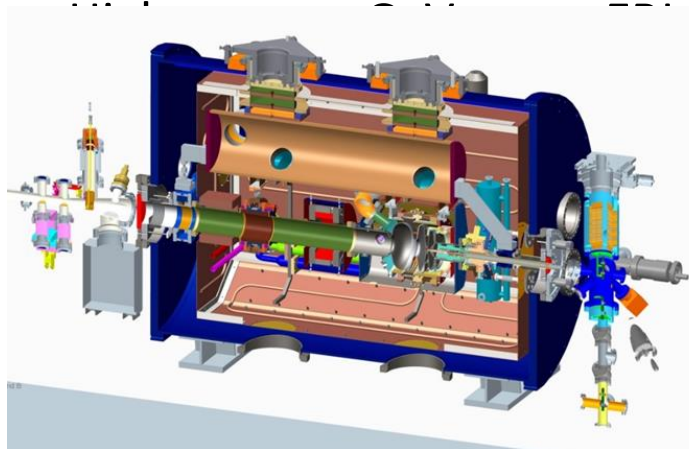

## ■ sc technology

■ high fields / gradients, high Q(quality)

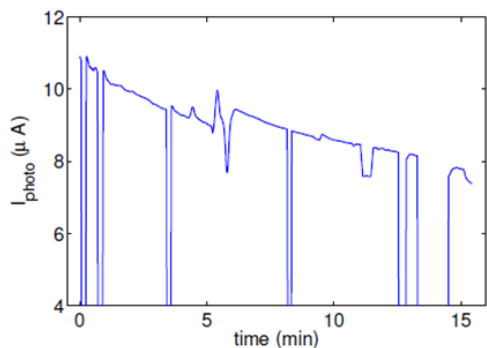
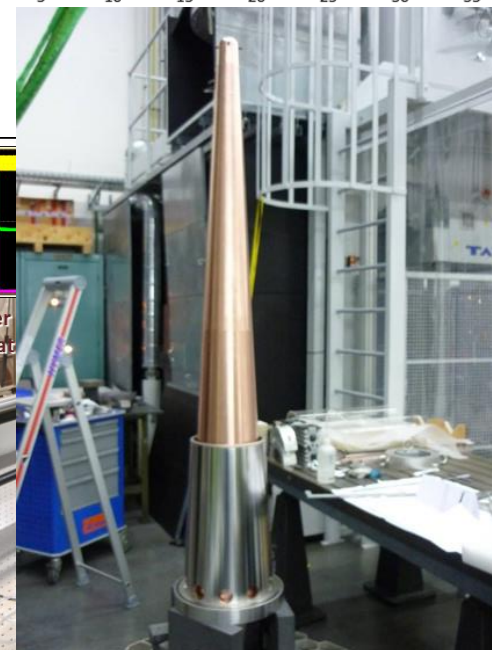
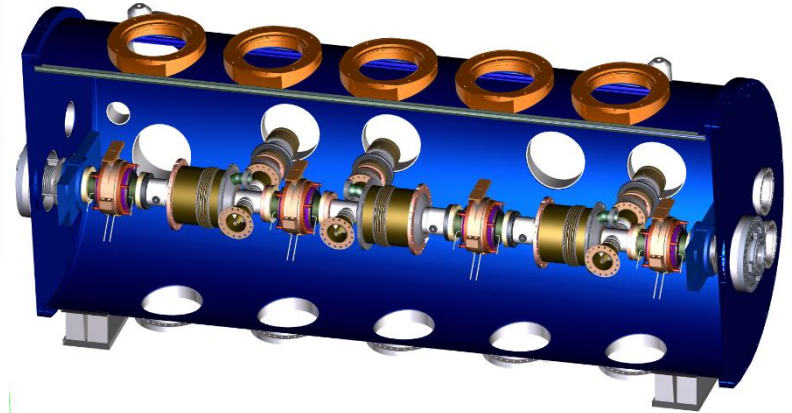

Figure 3: Photocurrent from the Cs<sub>3</sub>Sb photocathode under illumination by a 5 mW green laser (532nm) over time. The drops in the signal are from manually blocking the laser light. The wiggle at about 5 minutes is due to a movement of the laser spot on the sample surface.



## Booster cavities and module are based on the Cornell design

(3 x 2 cell, 1.8 K, 4 MeV@100 mA = 400 kW real beam power, 2 x 230 kW klystron)



## Linac cavities and module (HZB design)

(3 x 7 cell, 1.8 K, 44 MeV@2x100 mA, zero net beam-loading, 3 x 10 kW SSA)

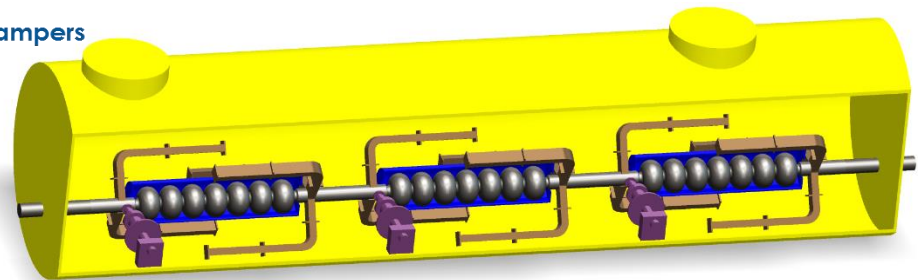
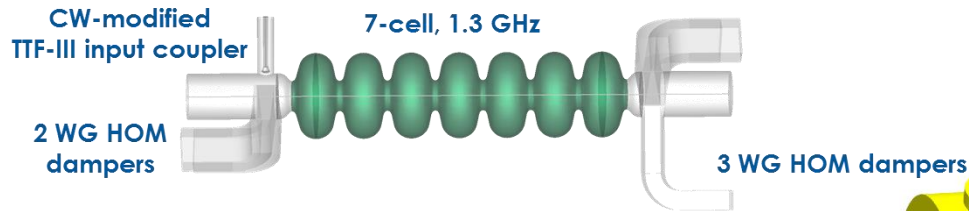

# Radiation protection for ERL – shielding

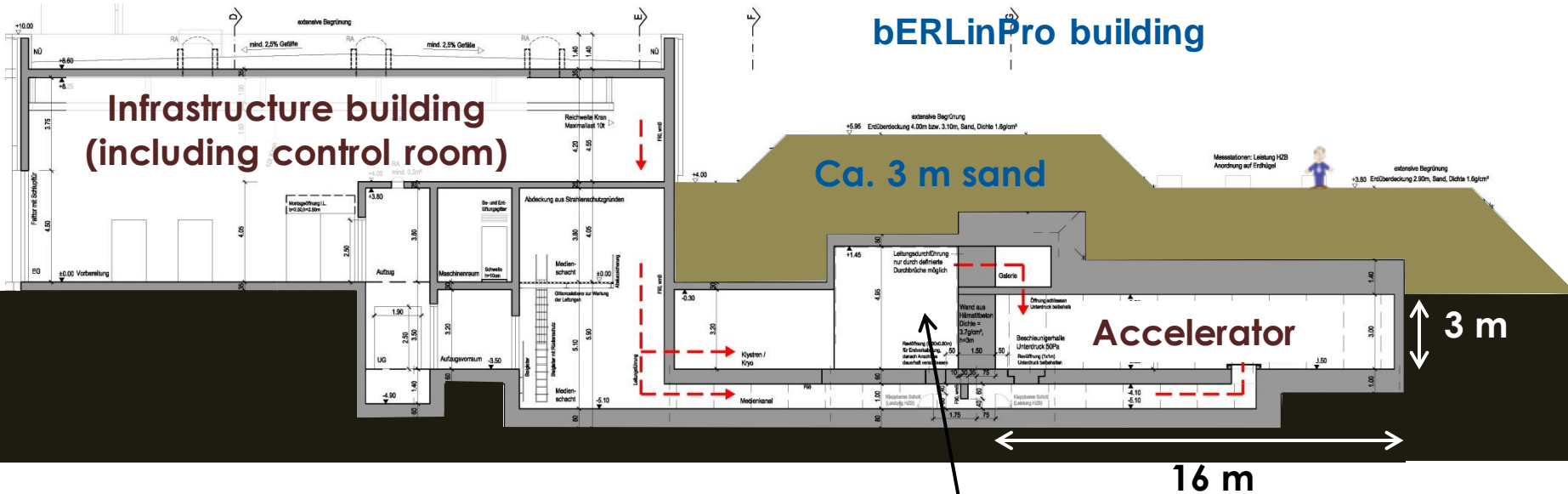

**Partially shielded ante-room for equipment close to the accelerator (klystron, cold-compressor for cryogenics)**

## Fluka calculations (K. Ott, HZB)

**50 MeV, 100 mA = 5 MW**  
→ kW losses easily possible

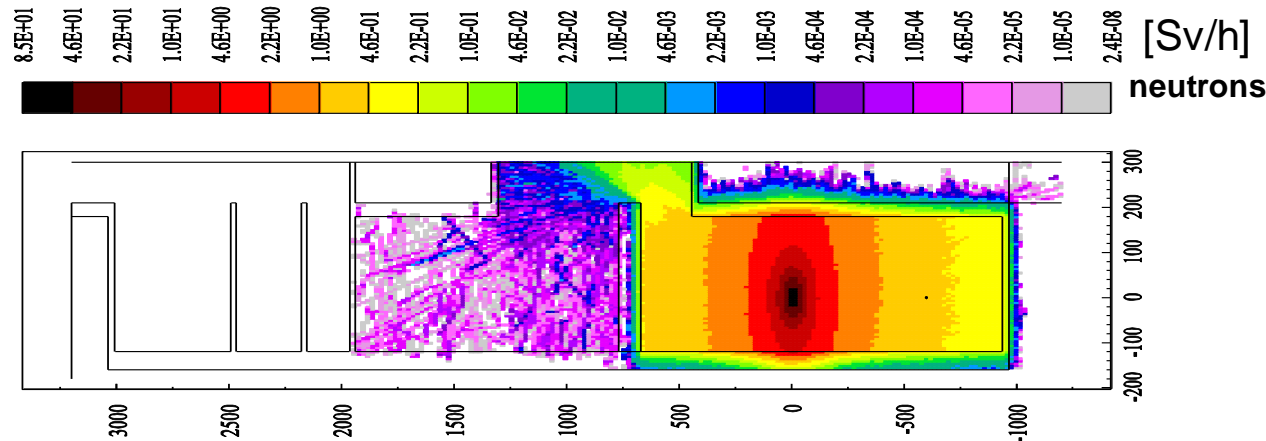



# bERLinPro – building construction started 02/2015



# bERLinPro – performance parameter (simulations)

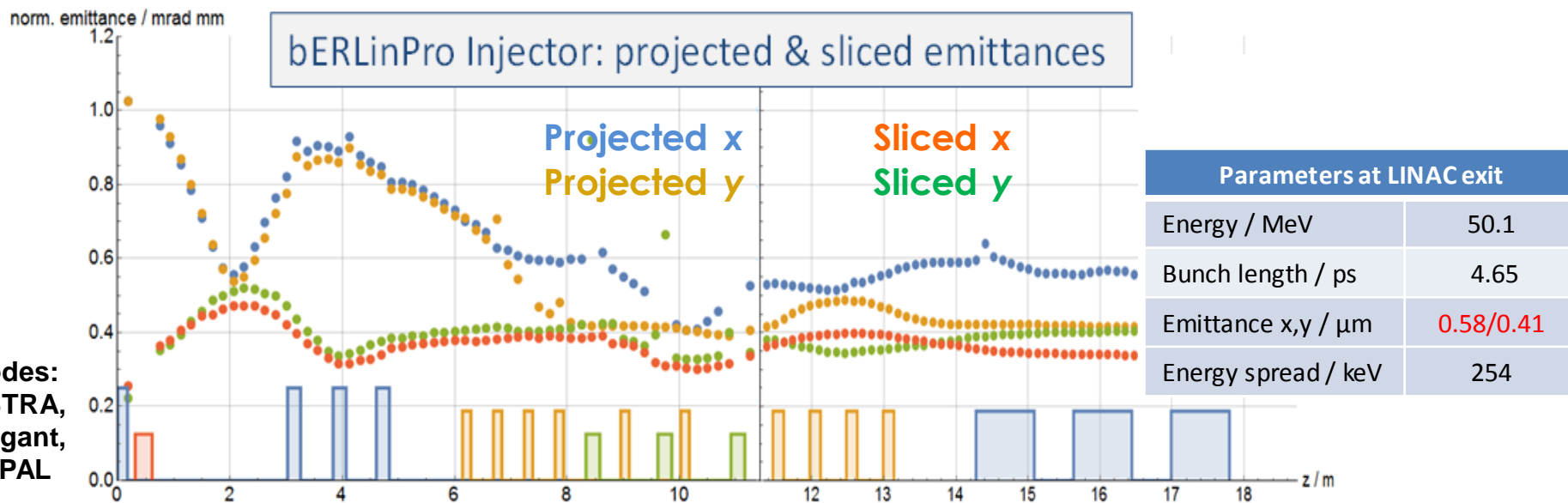

Optics (Short Bunch Mode, 10 pC): Bunch size & Emittance

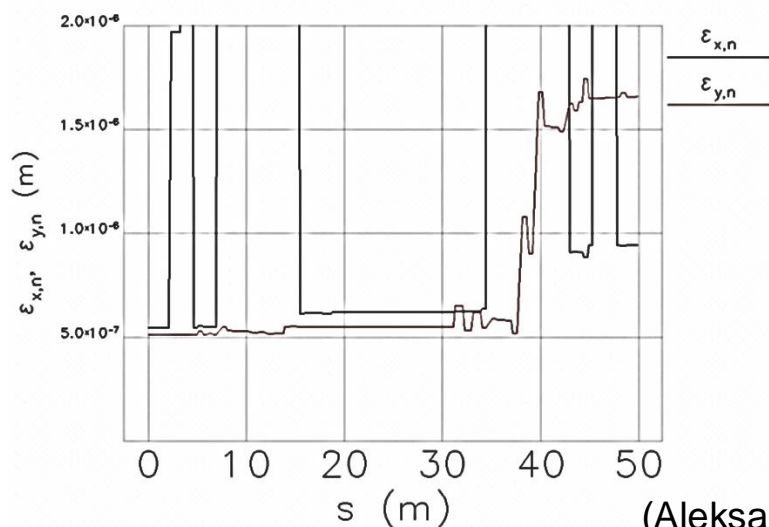

(Aleksandr Matveenko)

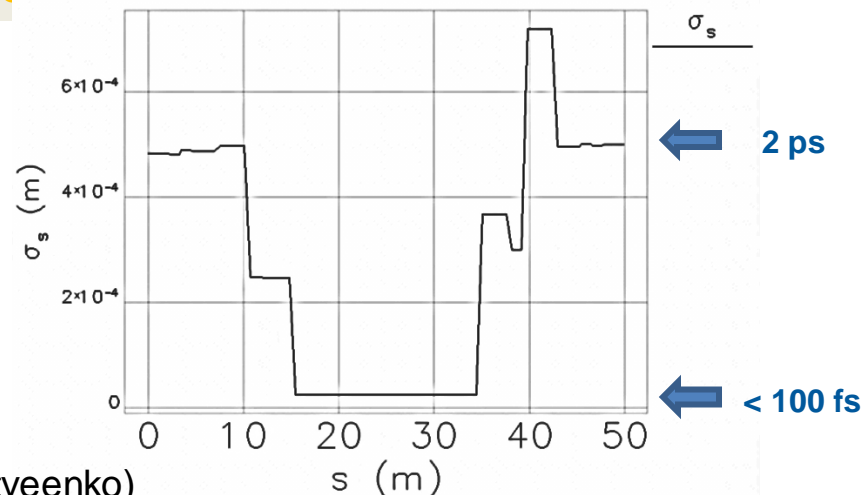

sigma matrix--input: recirc.ele lattice: recirc\_ff.lte

sigma matrix--input: recirc.ele lattice: recirc\_ff.lte

**Beam Break Up:** resonant interaction of short & long range cavity wake fields with the generating bunch or subsequent bunches → **instability & beam loss**

e.g. **Multibunch BBU:** many flavours: cumulative / regenerative, transverse / longitudinal, single-/multi-cavity, single-/multiple-turn

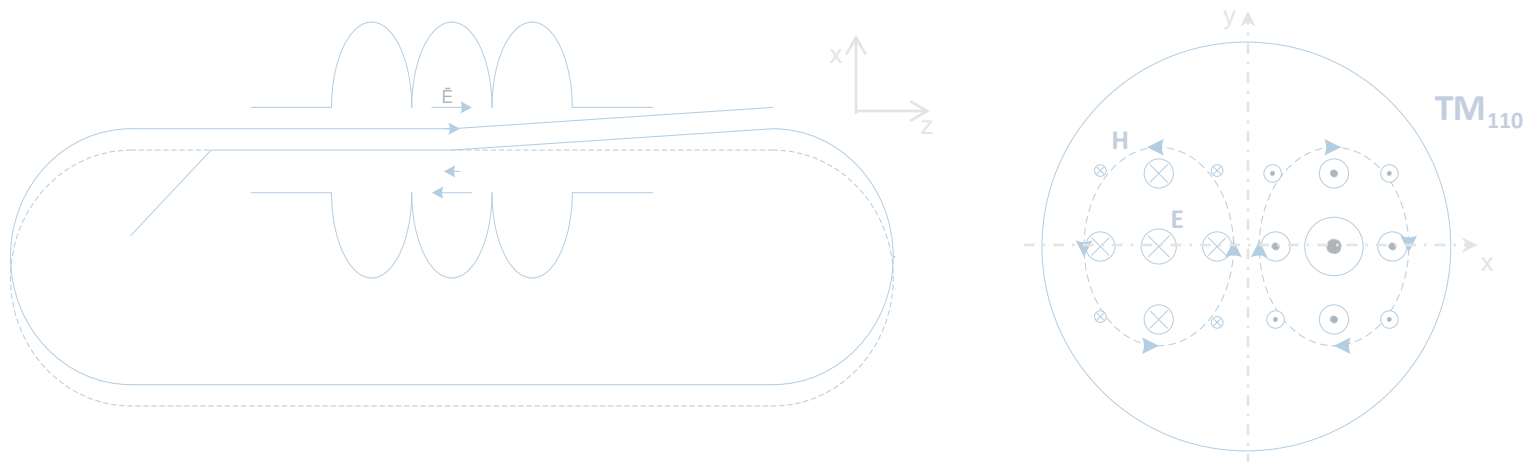

**regenerative transverse BBU (single cavity, single turn, one mode):**

1. bunch passes cavity “off axis” during accelerating passage → induce HOM voltage & transverse kick due to HOM
2. after recirculation kick transforms to an offset & HOM damp according to its Q
3. bunch passes cavity with varied offset on decelerating passage → induce HOM voltage & transverse kick due to HOM

**BBU: HOM excitation exceeds HOM damping → kick strength growth up to loss**

$$I_{th} = \frac{2pc^2}{e\omega_\lambda \left(\frac{R}{Q}\right)_\lambda Q_\lambda m^* \sin(\omega_\lambda T_{rec})}$$

**BBU threshold current**

## Countermeasures

### 1. cavity design:

- HOMs: small R/Q, varying  $\omega_\lambda$  at fixed  $\omega_0 \rightarrow$  multi cavity BBU thresholds increase
- no HOM on a fundamental's harmonics:  $\omega_\lambda \neq n^* \omega_{rf}$
- low Q for HOM  $\rightarrow$  HOM dampers (ferrites, waveguides, ...)

### 2. recirculator beam optics:

- for  $\alpha=0$  & uncoupled beam transport  $\rightarrow m^* = m_{12} = (\beta_1 \beta_2)^{1/2} \sin(\Delta\phi_x)$   
 $\rightarrow$  stable for  $\Delta\phi = n\pi$
- adjust  $\sin(\omega_\lambda T_{rec}) = 0$  for worst HOM  
 large path length change  $\rightarrow$  impractical ☹️

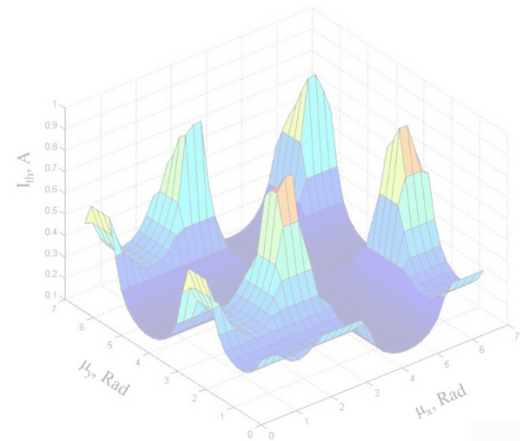

Y. Petenev

E. Pozdeyev et al.: Multipass beam breakup in energy recovery linacs, NIM-A 557 (2006) 176–188

G. Hoffstaetter et al.: Beam-breakup instability theory for energy recovery linacs, PRST-AB 7, 054401 (2004)

G. Hoffstaetter et al.: Recirculating beam-breakup thresholds for polarized higher-order modes with optical coupling, PRST-AB 10, 044401 (2007)



$$I_{th} = \frac{2pc^2}{e\omega_\lambda \left(\frac{R}{Q}\right)_\lambda Q_\lambda m^* \sin(\omega_\lambda T_{rec})}$$

**BBU threshold current**

## Countermeasures

### 2. recirculator beam optics (continued):

- coupled beam transport: switching of planes  $M=((M_x,0),(0,M_y)) \rightarrow M=((0,M_{yx},0),(0,M_{xy}))$   
 $m_{12}=0 \rightarrow$  horizontal HOM kick transforms to vertical offset  $\rightarrow$  HOM not further excited by the oscillatory part of  $x_2$   
 $\rightarrow$  two options: solenoid (low energy), rotator

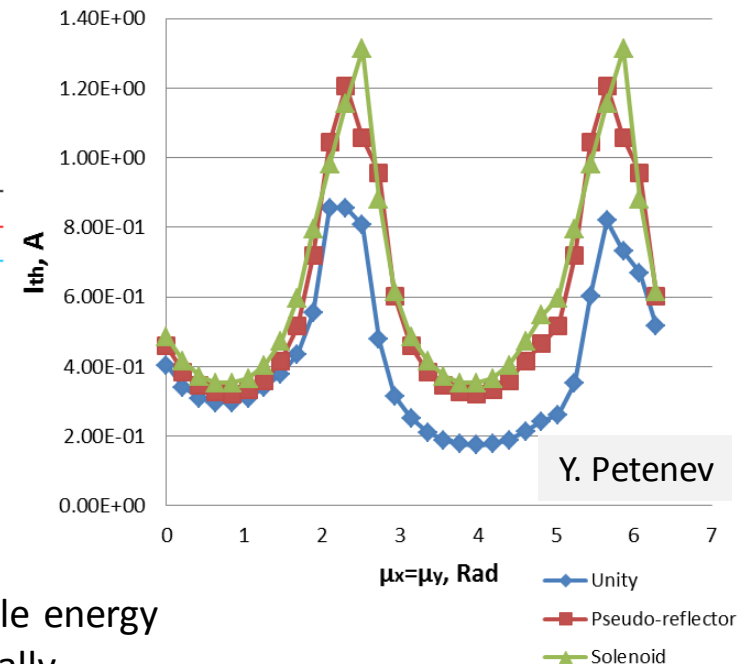
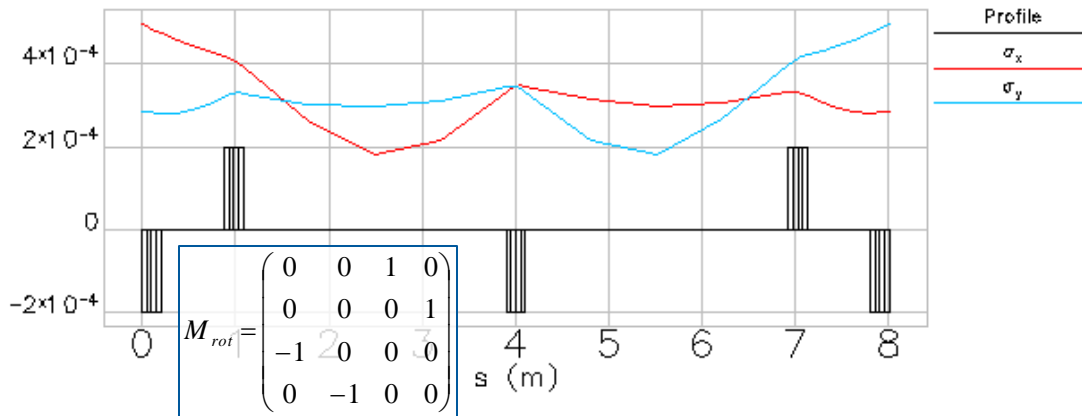

- chromaticity of the arcs, together with reasonable energy spread, can raise the threshold current dramatically  
 - kick smears out, de-phasing - (V. Litvinenko, PRST-AB 15, 074401 (2012))

## Unwanted Beam

### Halo

generated by / together with wanted beam

- scattered particles (residual gas, IBS)
- laser stray light on cathode
- laser: limited extinction ratio
- ... (?)

**moving together with wanted beam at design rf phases → same energy, no dispersive separation**

### Dark Current

generated independently of wanted beam (laser off)

- field emission in rf cavities
- ghost pulses from laser
- ... (?)

beside Dark Current from the gun → lower energy than wanted beam → lost in dispersive regions









## Unwanted Beam

Amount:

- not reliably predictable for most sources

Loss positions:

- with initial beam parameter (place of origin, momenta) loss position along the machine can be calculated for the various generation processes → loss probability (to be weighted with unknown loss current ☹)

source	generating process	loss positions	amount
Halo	scattered Particles		
	stray light – laser halo		
Dark Current	field emission gun cath & plug		
	field emission booster & linac		

UBW 2012: <https://indico.helmholtz-berlin.de/conferenceDisplay.py?confId=2>

- Halo:**
1. residual gas scattering
  2. intra beam scattering  $\rightarrow$  Touschek losses
  3. laser stray light from cathode

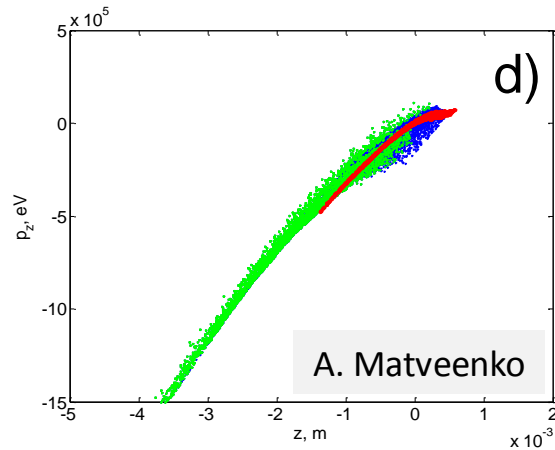
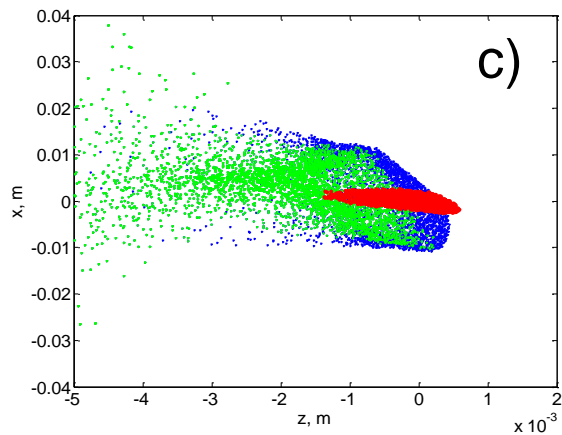
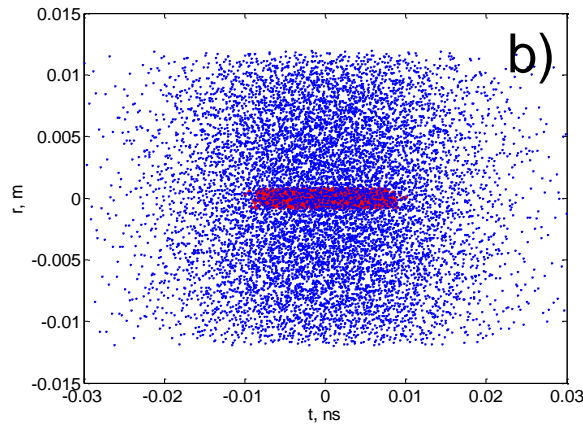
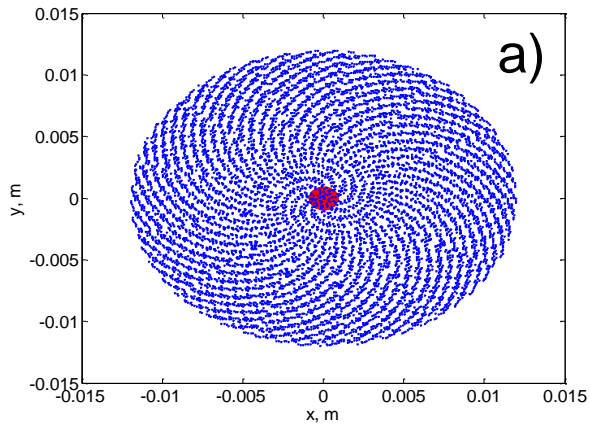

## **Beam halo modeling:**

particle distribution from ASTRA.

red – active beam particles,

blue – passive halo particles,

green – particles lost in collimators.

Initial distribution on the cathode in

a)  $x$ - $y$  plane,

b)  $x$ - $t$  plane.

Particle distribution after the merger section in

c)  $x$ - $z$  plane,

d)  $p_z$ - $z$  plane.

$\rightarrow$  Collimation of large fraction of halo particles, **but not 100%**.

**bERLinpro:** one testing collimator in the merger section



## Dark Current: field emission from gun cathode

### Field Emission from gun cathode

- Fowler Nordheim:  $\varphi = 1.9$  eV,  $\beta = 200$ ,  $E_{\max} = 30$  MV/m
- tracking trough merger incl. SC of reference bunch
- x-y apertures in booster & merger  $\rightarrow$  loss distribution

$$j(E) = \frac{A_{FN}(\beta_{FN}E)^2}{\varphi} \exp\left(-\frac{B_{FN}\varphi^2}{\beta_{FN}E}\right)$$

*E – electric field,  $\varphi$  – work function*

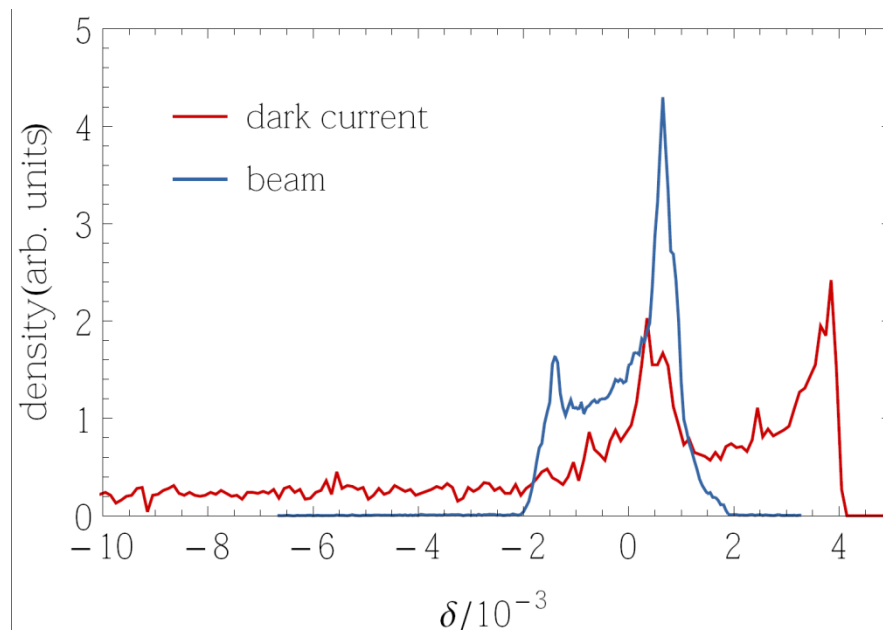
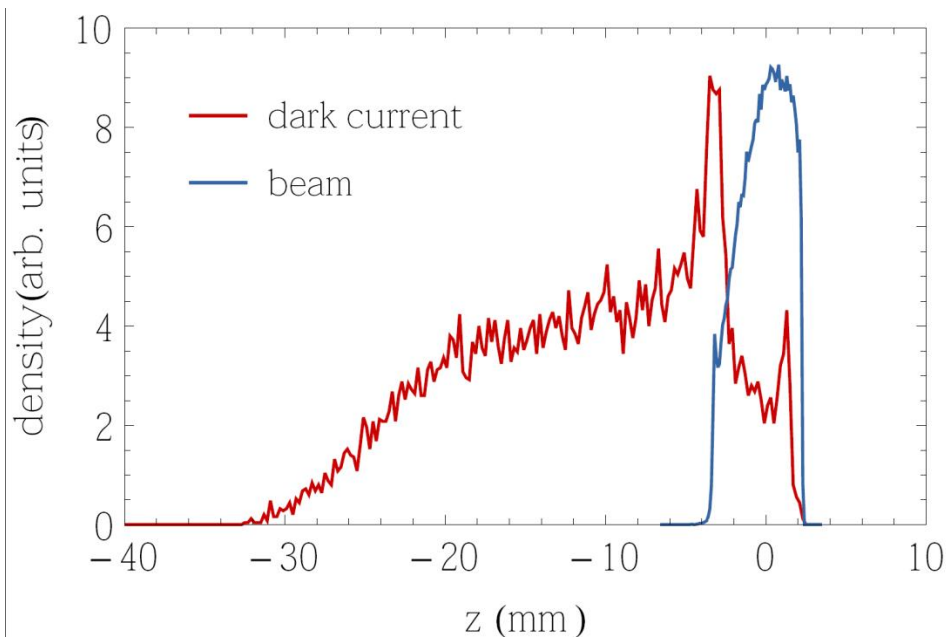

S. Wesch

# ERL Beam Dynamics – Unwanted Beam / field emission

- Dark Current:**
- consuming rf power (linac)
  - MPS relevant:  $\mu\text{A}$  @ tens of MeV  $\rightarrow 10^2 \dots 10^3 \text{ W}/??$
  - radiation safety issue

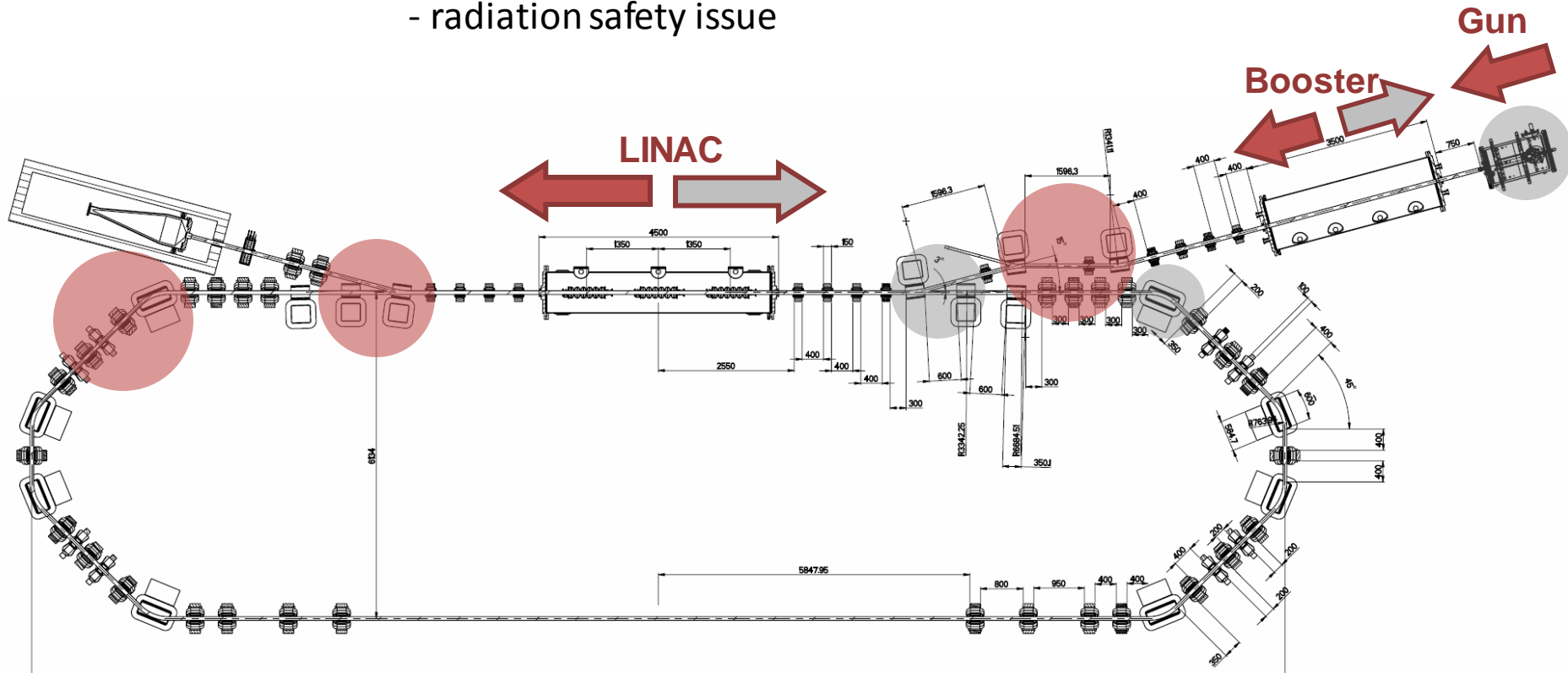

- dark current from booster ( $E_{\text{max}} = 4.5 \text{ MeV} \rightarrow \Delta E > 30\%$ ) will be lost in merger
- dark current from linac ( $E_{\text{max}} = 44 \text{ MeV} \rightarrow \Delta E > 13\%$ ) will be lost in the 1<sup>st</sup> arc bend

**Only dark current from gun will potentially reach the recirculator!**

Energy Recovery Linacs can provide high current, high quality beams for single pass experiments in flexible setups

multi user light sources, collider, cooler, compact sources, ...

cw superconducting RF is the enabling technology

high gradient, large apertures

many challenges to be addressed

low emittance/high current sources, HOM damped cavities (BBU), flexible bunch compression, control of unwanted beam, optimising SRF efficiency (high gradient, high  $Q_0$ )

ongoing, worldwide effort to push ERL technology

bERLinPro, cERL, BNL ERL, Cornell Injector + FFAG ERL, CERN Test ERL, JLAB ERL-FEL, Beijing University & IHEP, ALICE, NovoERL, MESA, S-DALINAC

Thanks to many of my colleagues providing me data and information and to Michael Abo-Bakr for transparencies on bERLinPro beam dynamic issues.