

# Injection and extraction

- Kickers and septa
- Injection methods
  - Single-turn hadron injection
  - Injection errors, filamentation and blow-up
  - Multi-turn hadron injection
  - Charge-exchange H<sup>-</sup> injection
  - Lepton injection
- Extraction methods
  - Single-turn (fast) extraction
  - Non-resonant multi-turn extraction
  - Resonant multi-turn (slow) extraction

Brennan Goddard  
CERN

# Injection, extraction and transfer

- An accelerator has limited dynamic range.
- Chain of stages needed to reach high energy
- Periodic re-filling of storage rings, like LHC
- External experiments, like CNGS

Beam transfer (into, out of, and between machines) is necessary.

LHC:	Large Hadron Collider
SPS:	Super Proton Synchrotron
AD:	Antiproton Decelerator
ISOLDE:	Isotope Separator Online Device
PSB:	Proton Synchrotron Booster
PS:	Proton Synchrotron
LINAC:	LINear Accelerator
LEIR:	Low Energy Ring
CNGS:	CERN Neutrino to Gran Sasso

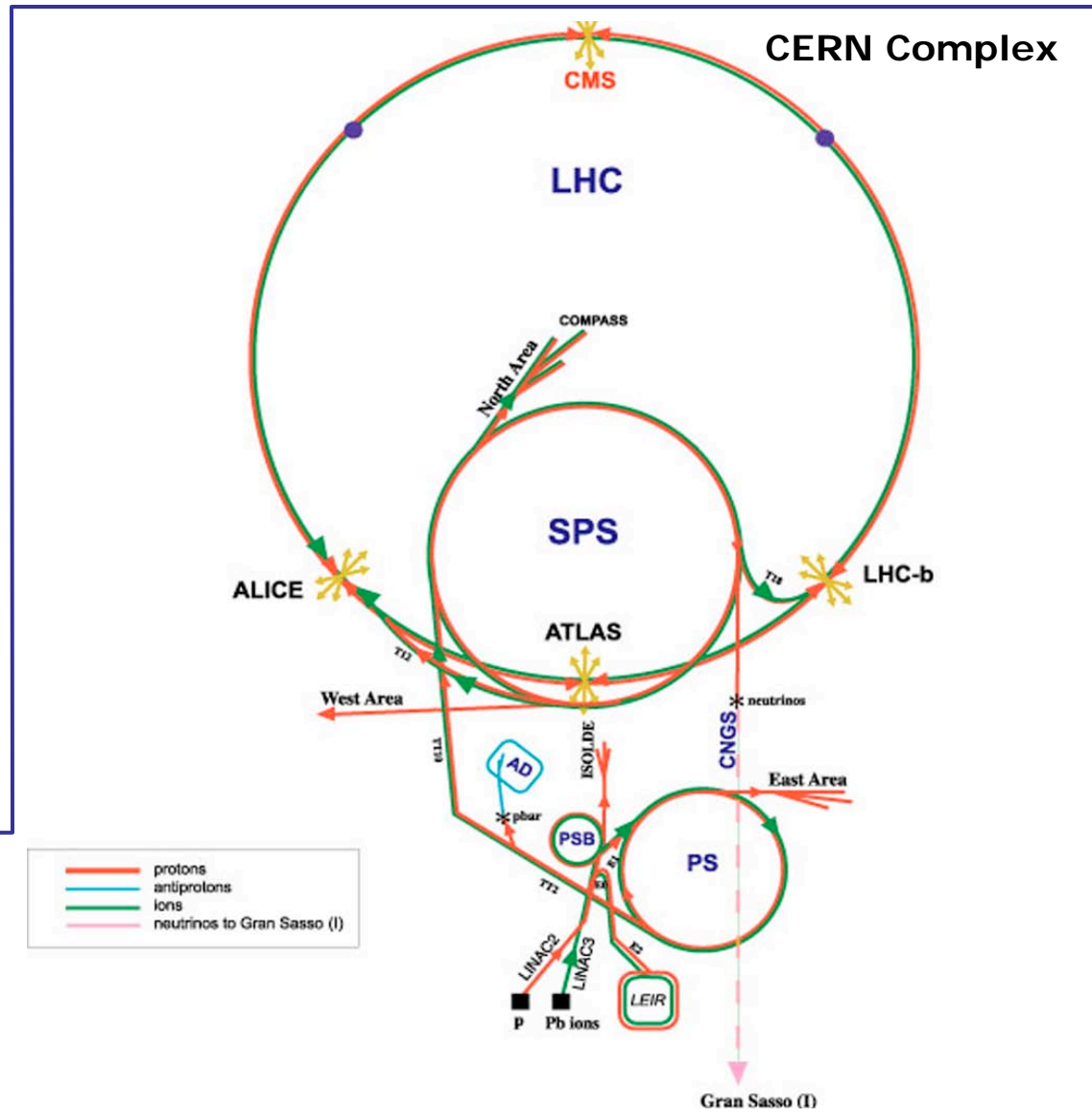

# Kicker magnet

Pulsed magnet with very fast rise time  
(100ns – few  $\mu$ s)

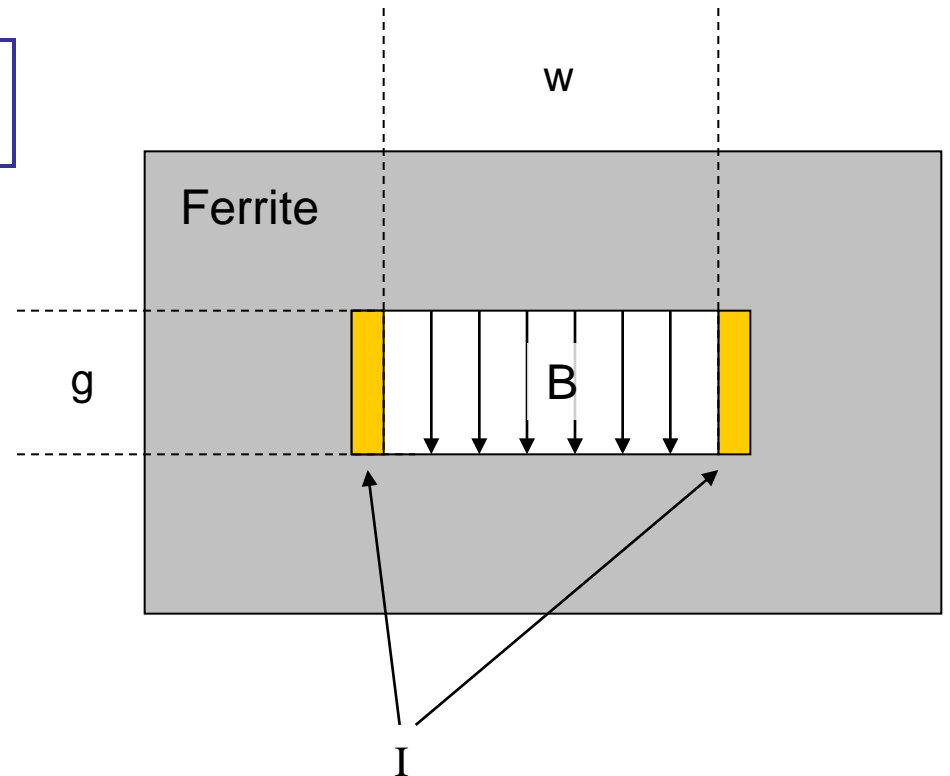

$$B = \mu_0 I / g$$

$$L = \mu_0 w l / g \quad (\text{magnet length } l)$$

$$dI/dt = V/L$$

Typically 3 kA in 1  $\mu$ s rise time

# Magnetic septum

Pulsed or DC magnet with thin (2-20mm) septum between zero field and high field region

Septum coil

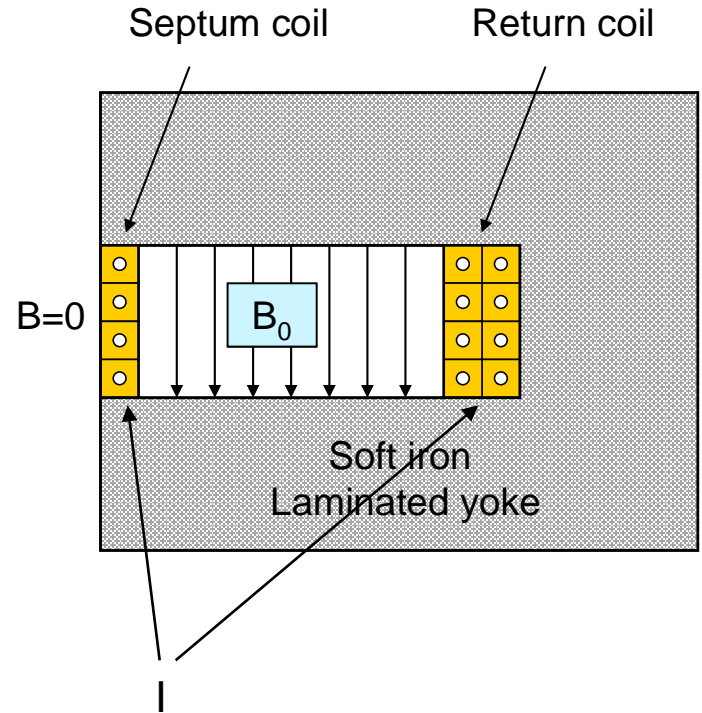
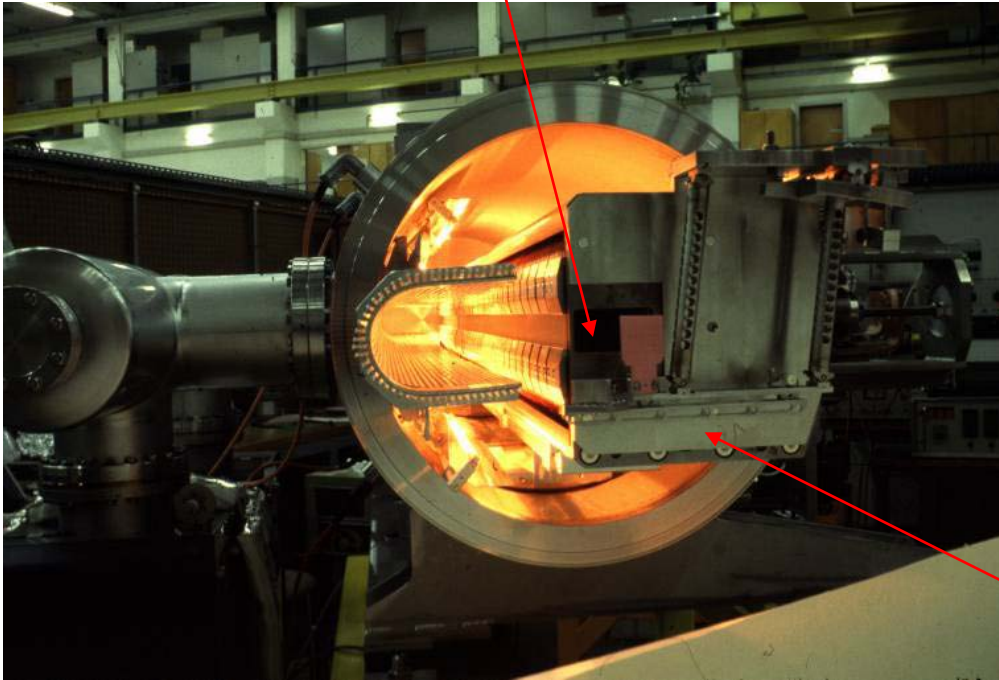

$$B_0 = \mu_0 I / g$$

Typically  $I$  5-25 kA

Yoke

# Electrostatic septum

DC electrostatic device with very thin ( $\sim 0.1$  mm) septum between zero field and high field region

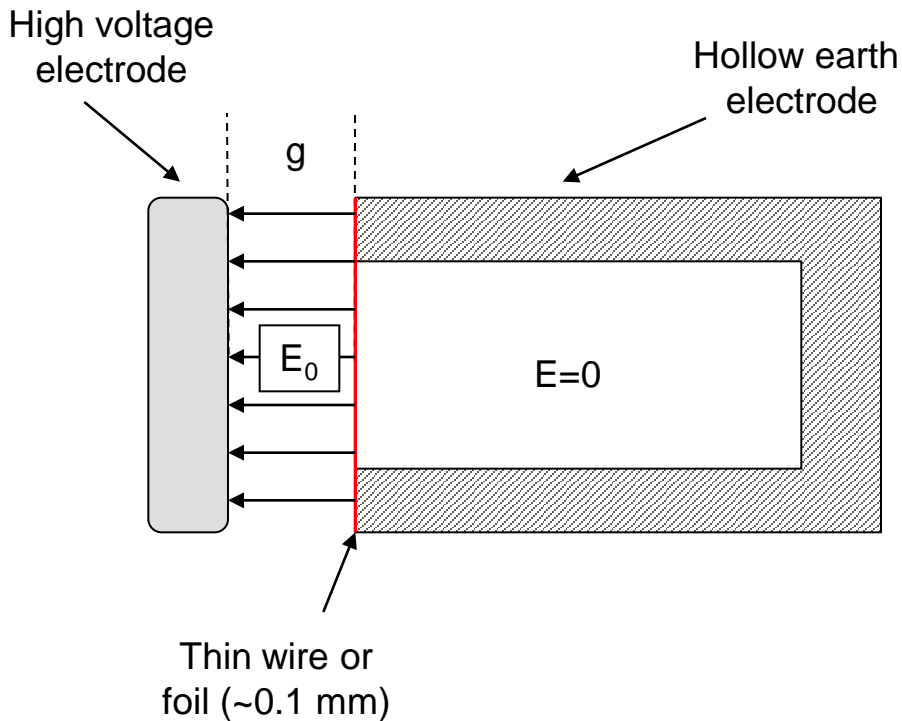

$$E = V / g$$

Typically  $V = 200$  kV

$$E = 100$$
 kV/cm

High Voltage Electrode

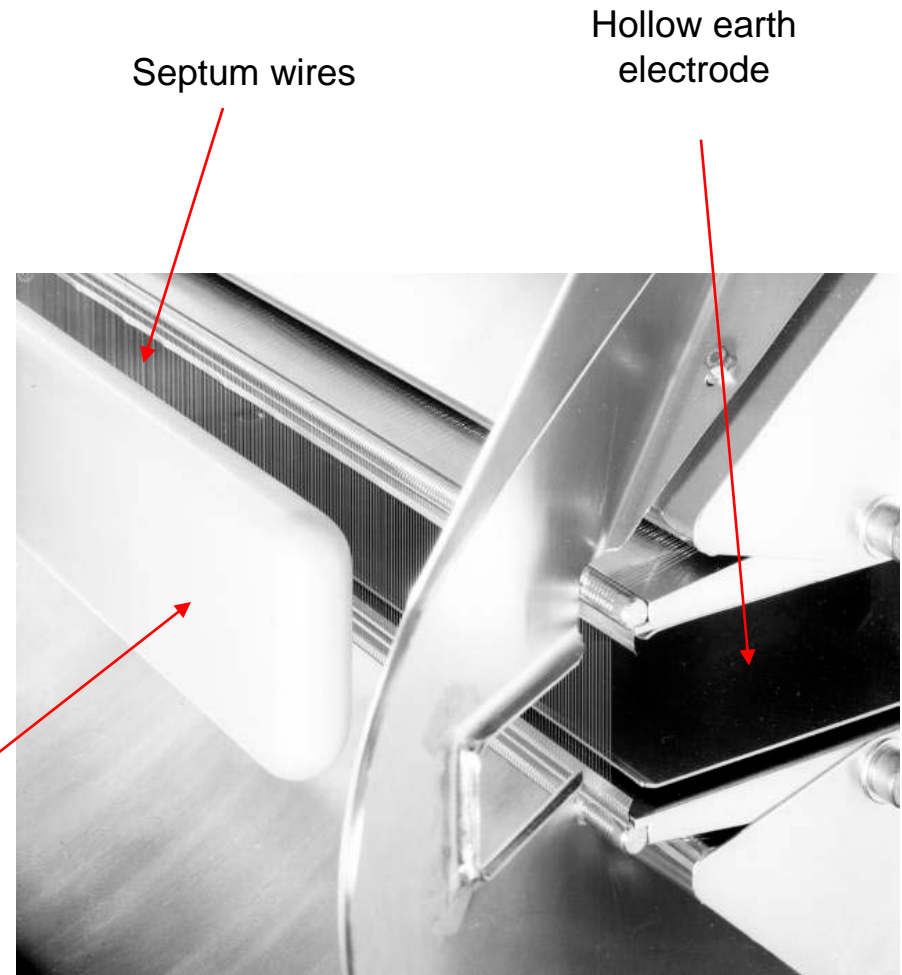

# Normalised phase space

- Transform real transverse coordinates  $x, x'$  by

$$\begin{bmatrix} \bar{X} \\ \bar{X}' \end{bmatrix} = \mathbf{N} \cdot \begin{bmatrix} x \\ x' \end{bmatrix} = \sqrt{\frac{1}{\beta_s}} \cdot \begin{bmatrix} 1 & 0 \\ \alpha_s & \beta_s \end{bmatrix} \cdot \begin{bmatrix} x \\ x' \end{bmatrix}$$

$$\bar{X} = \sqrt{\frac{1}{\beta_s}} \cdot x$$

$$\bar{X}' = \sqrt{\frac{1}{\beta_s}} \cdot \alpha_s x + \sqrt{\beta_s} x'$$

# Normalised phase space

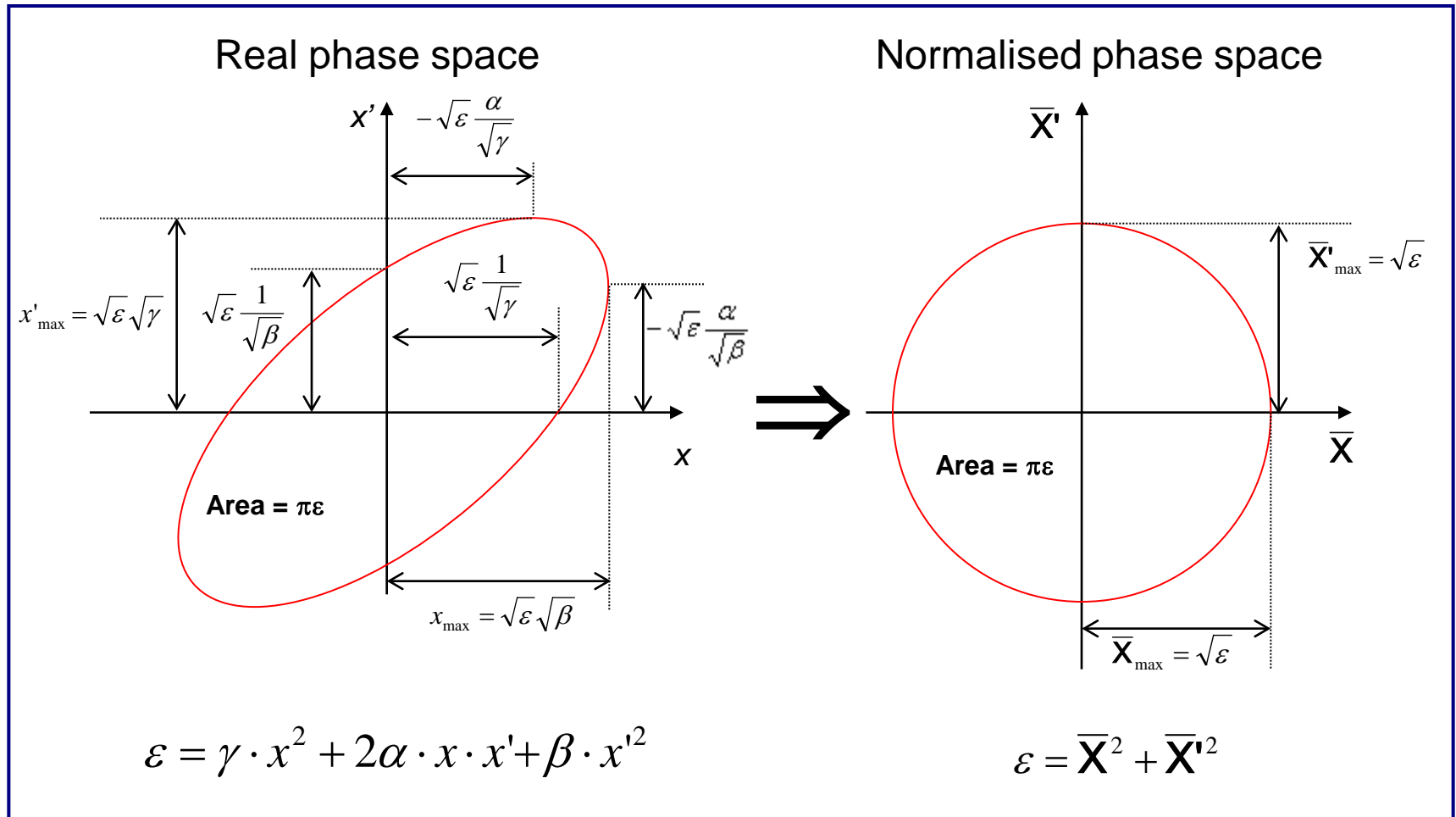

# Single-turn injection – same plane

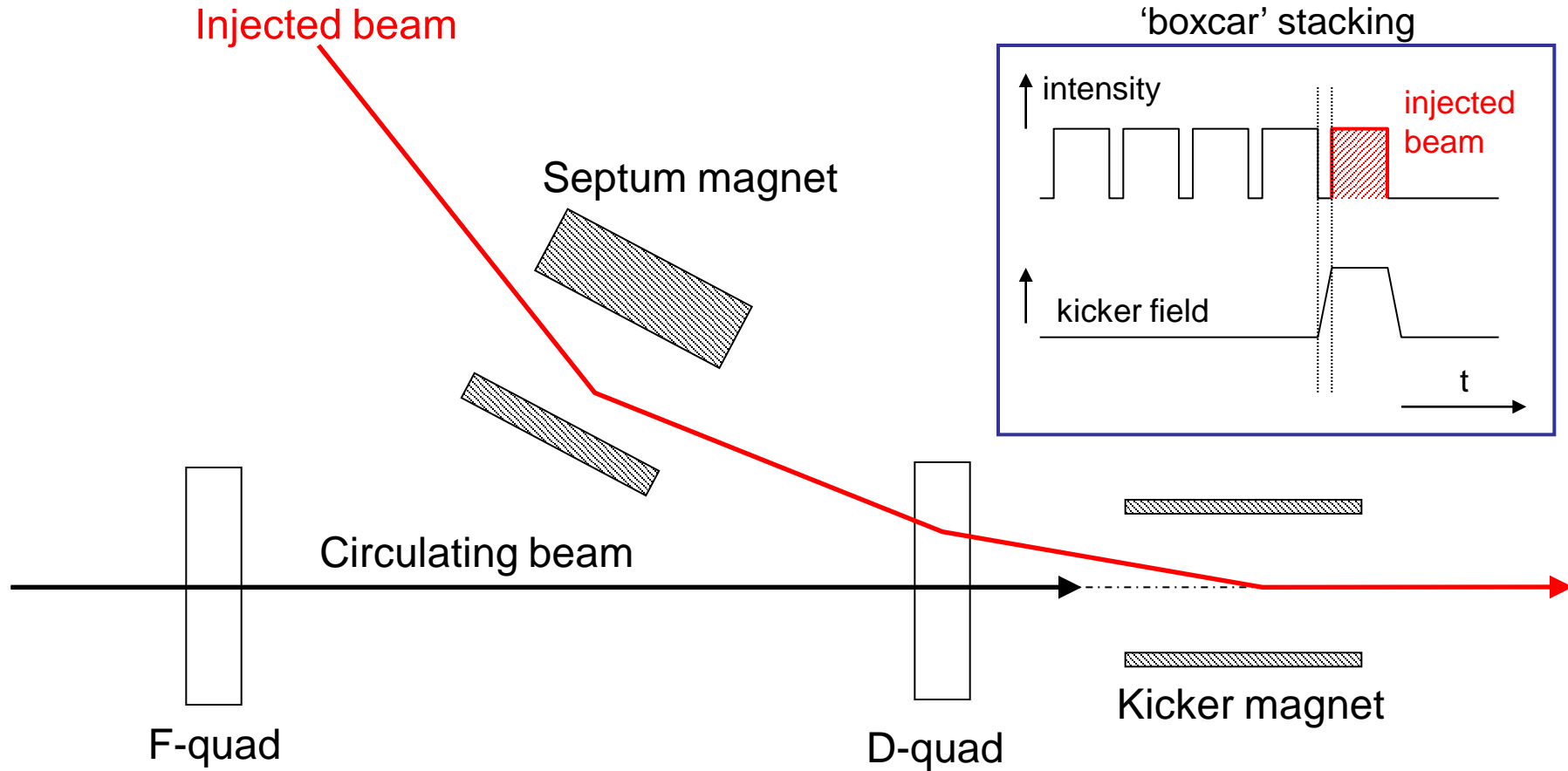

- Septum deflects the beam onto the closed orbit at the centre of the kicker
- Kicker compensates for the remaining angle
- Septum and kicker either side of D quad to minimise kicker strength



# Single-turn injection

Normalised phase space at centre of idealised septum

Large deflection by septum

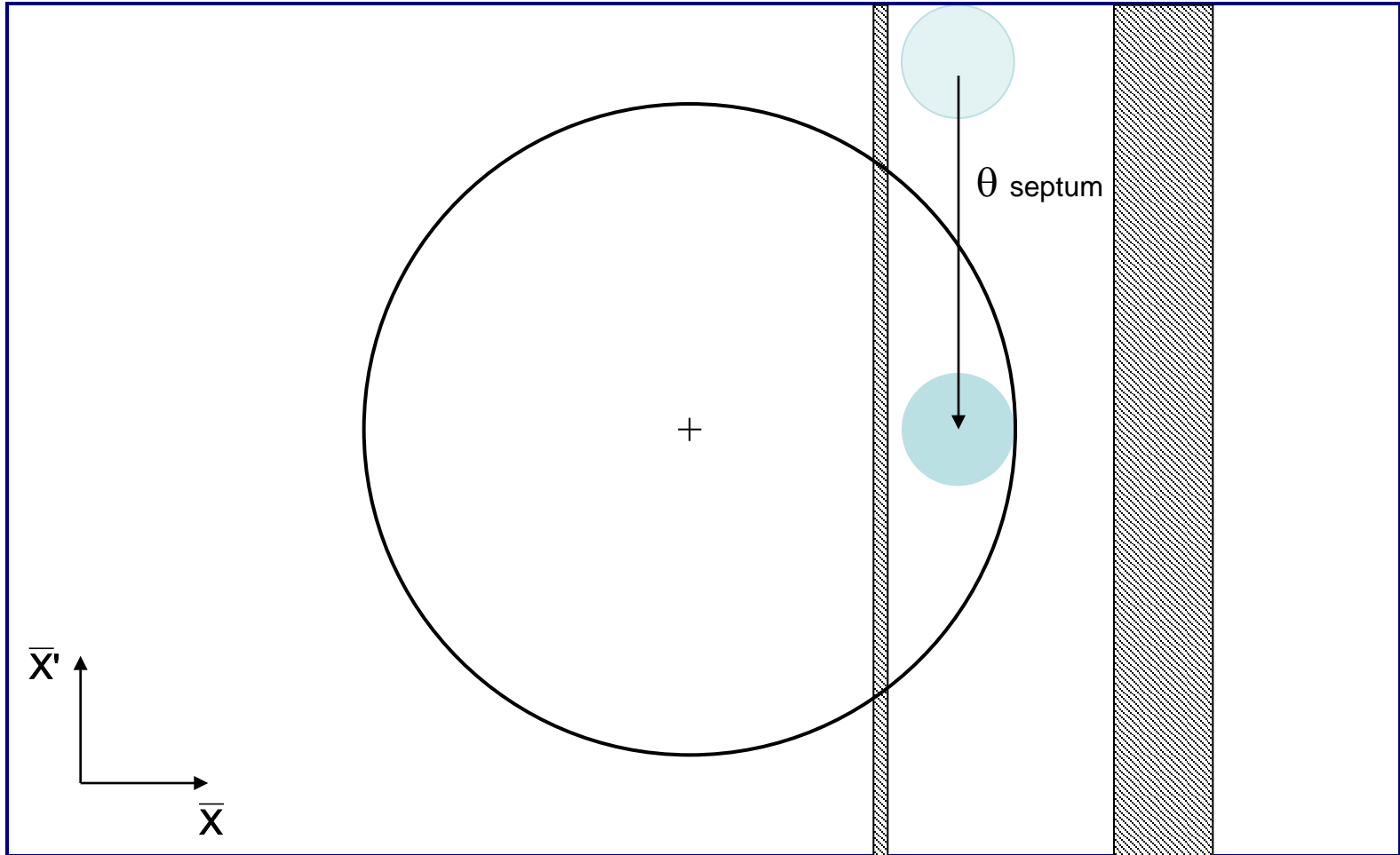

# Single-turn injection

$\pi/2$  phase advance to kicker location

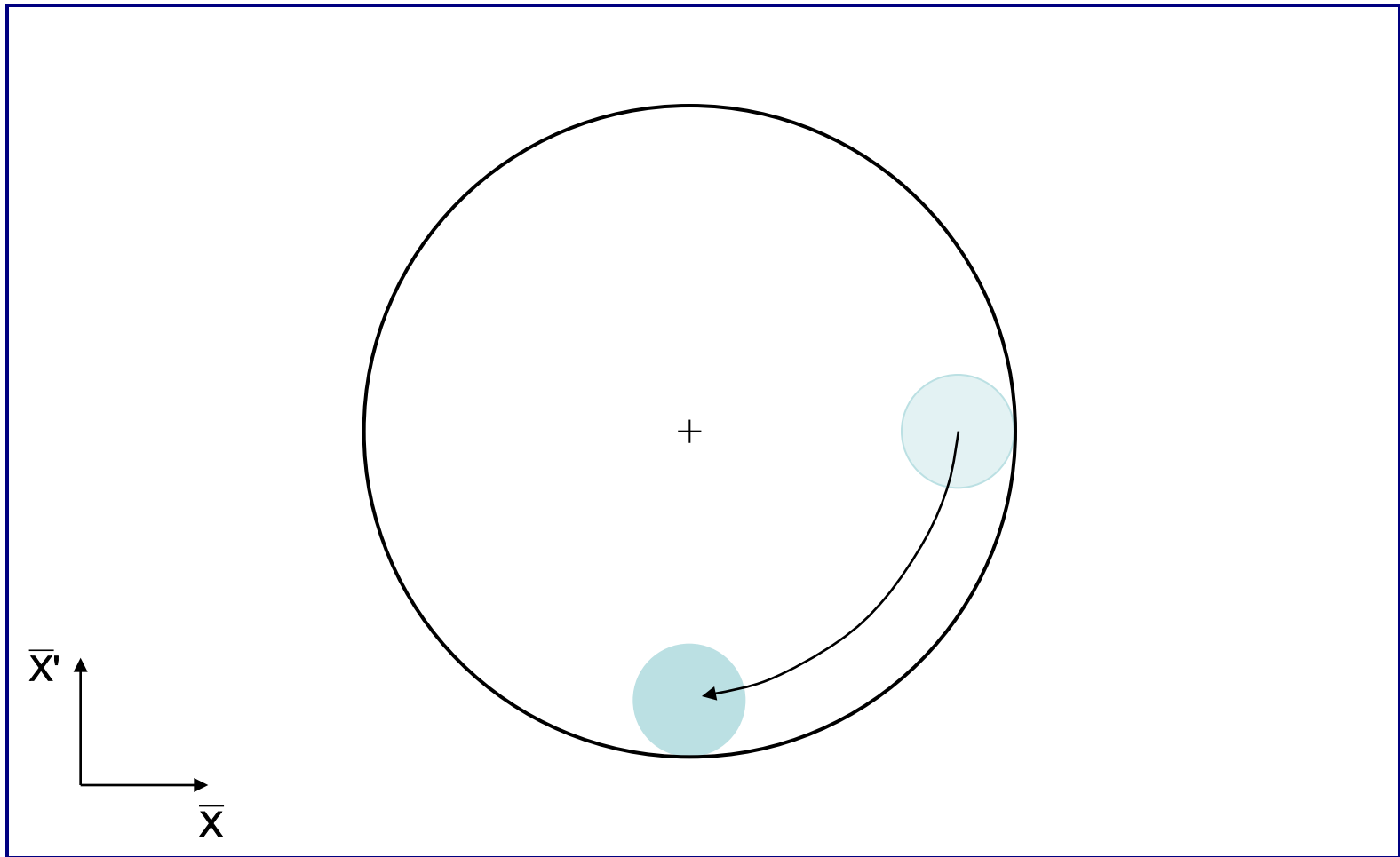

# Single-turn injection

Normalised phase space at centre of idealised kicker

Kicker deflection places beam on central orbit

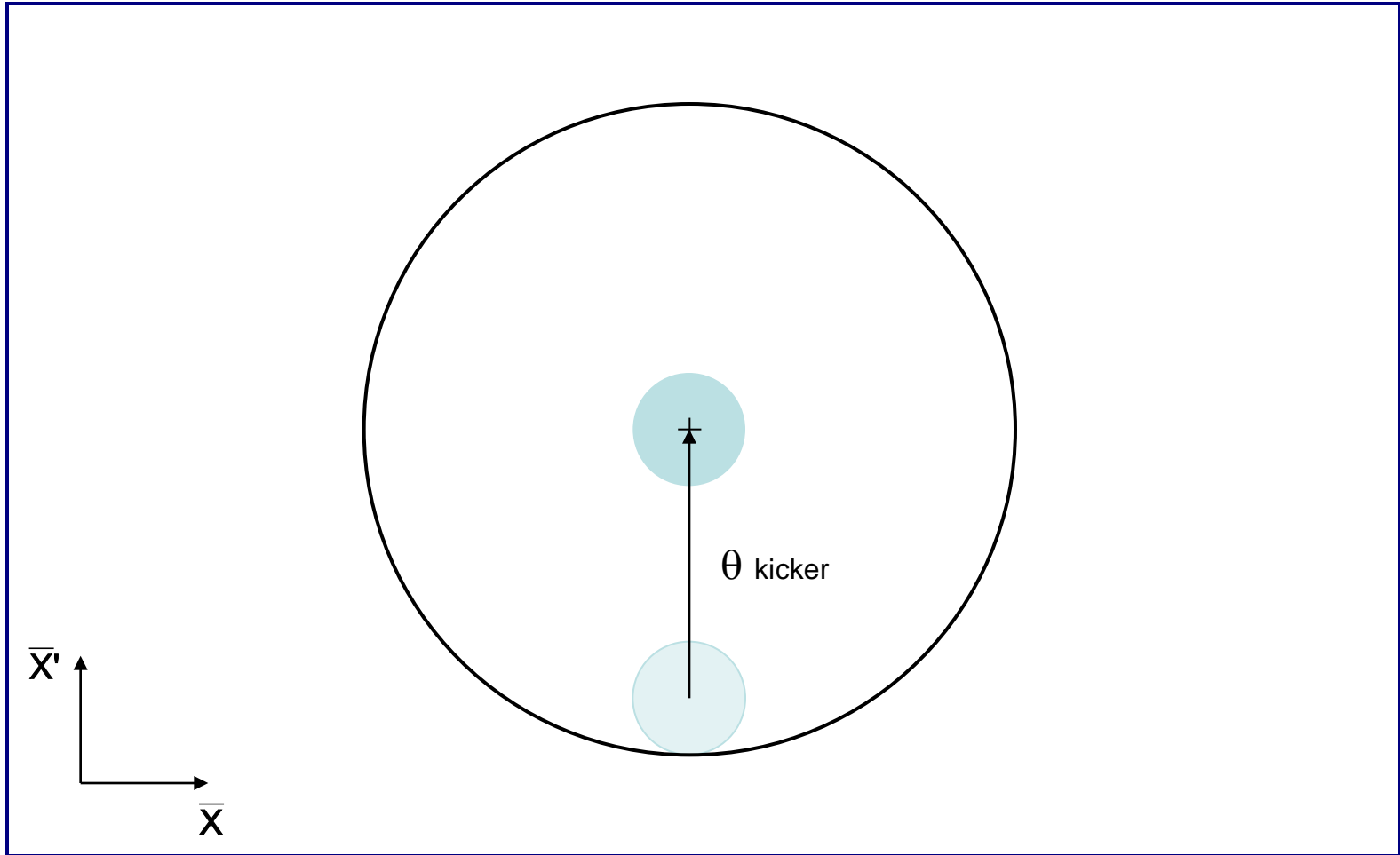

# Injection oscillations

For imperfect injection the beam oscillates around the central orbit. 1

kicker  $\theta$  error

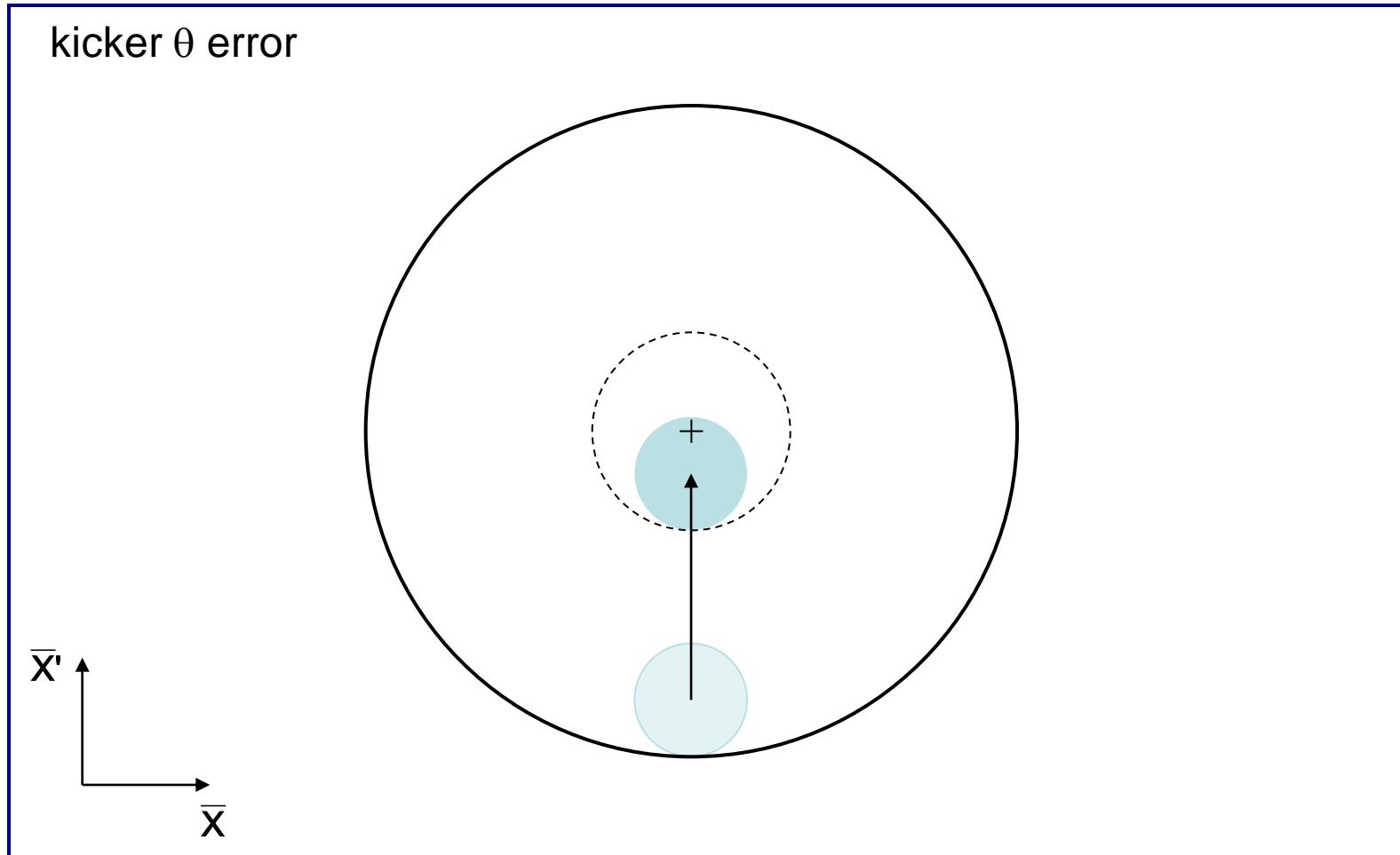

# Injection oscillations

For imperfect injection the beam oscillates around the central orbit. 2

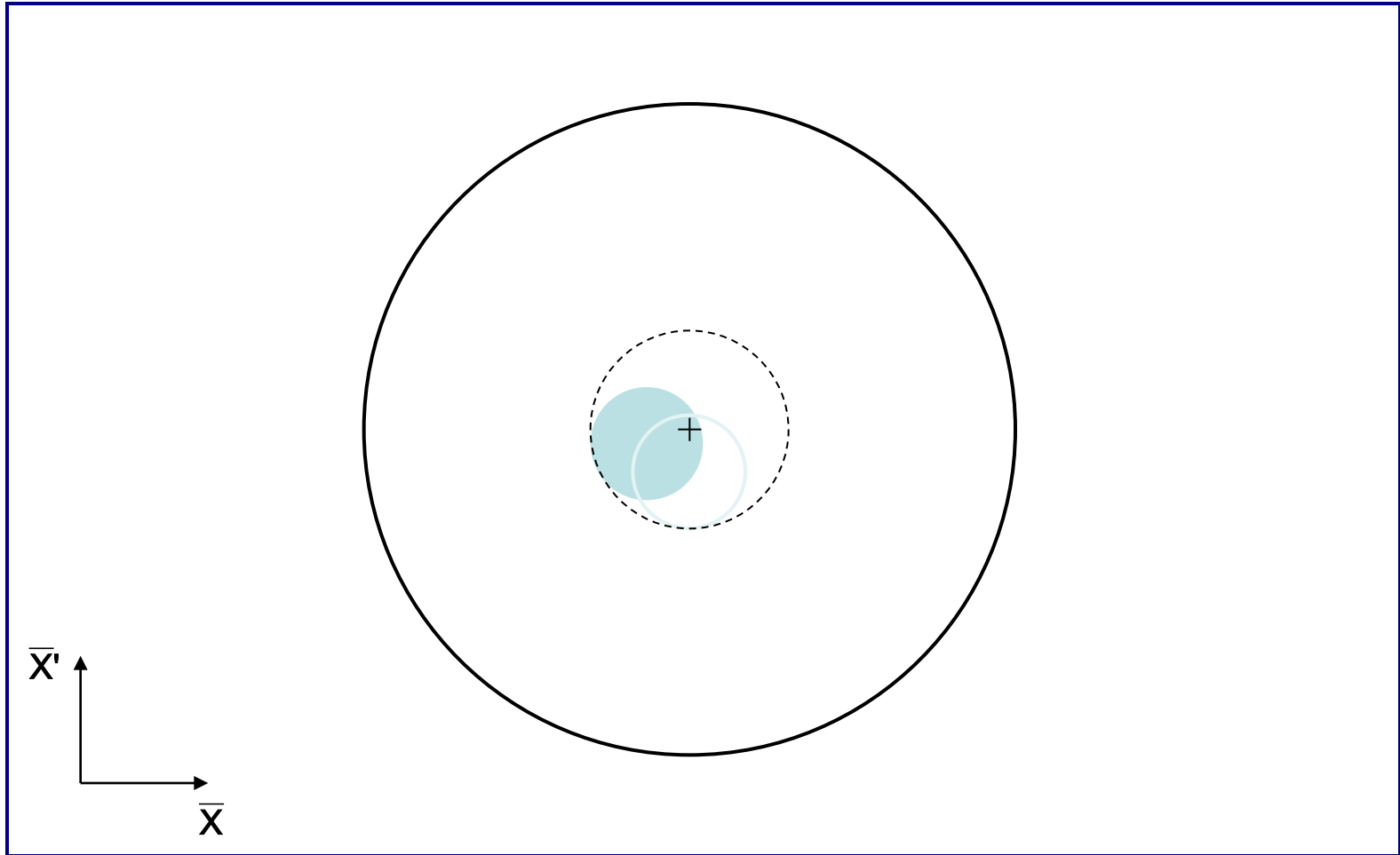

# Injection oscillations

For imperfect injection the beam oscillates around the central orbit. 3

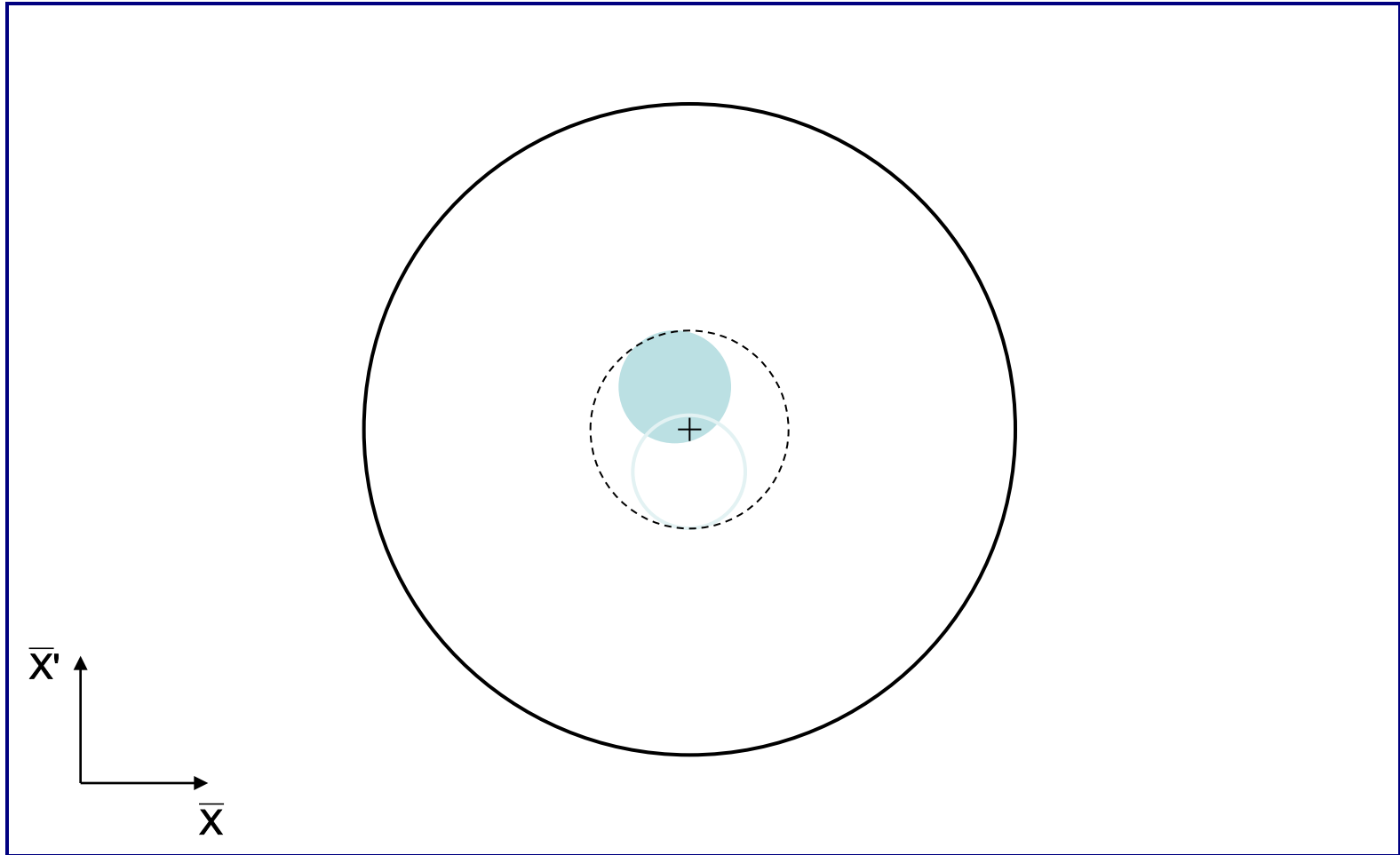

# Injection oscillations

For imperfect injection the beam oscillates around the central orbit. 4

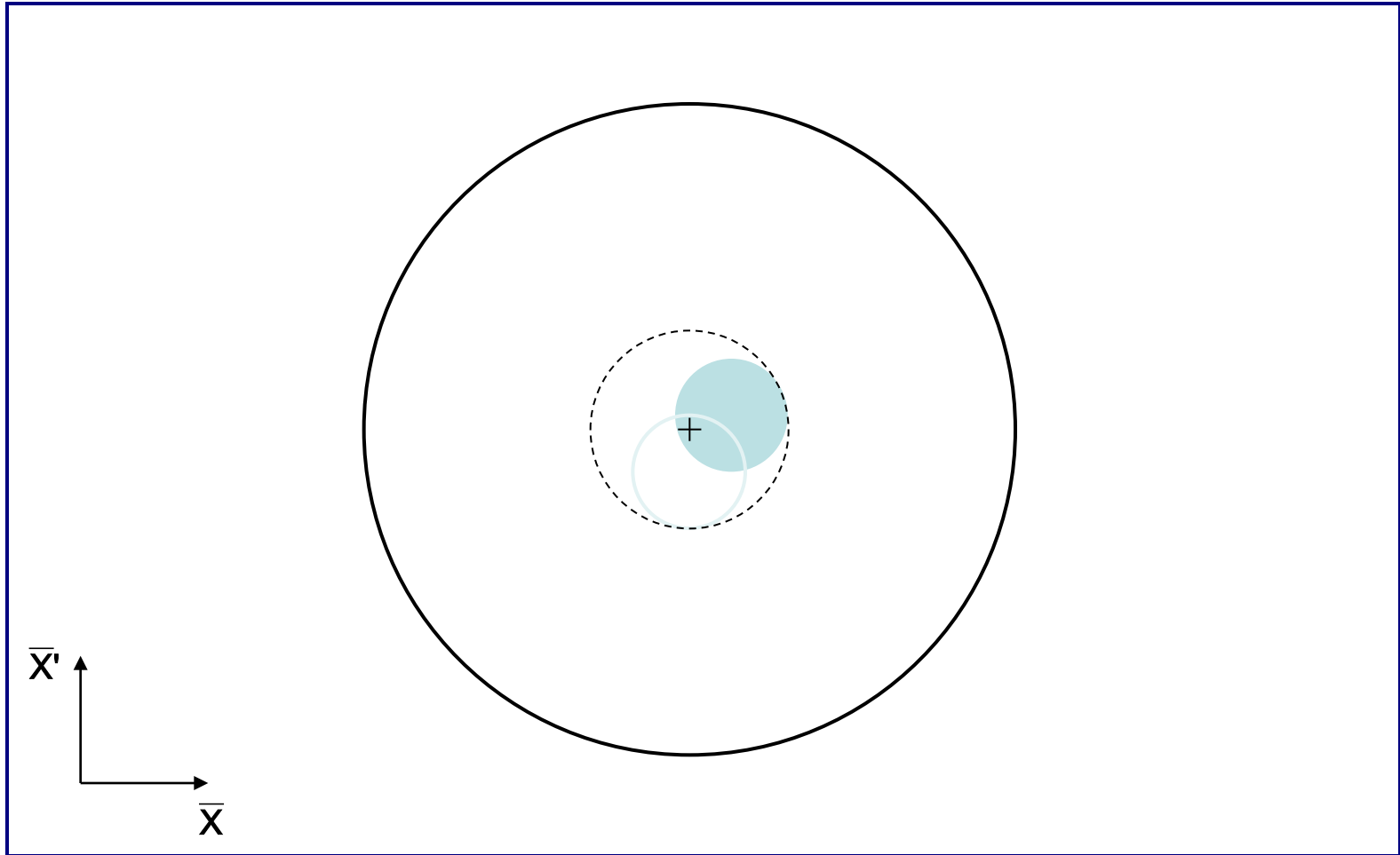

# Injection oscillations

- Betatron oscillations with respect to the Closed Orbit

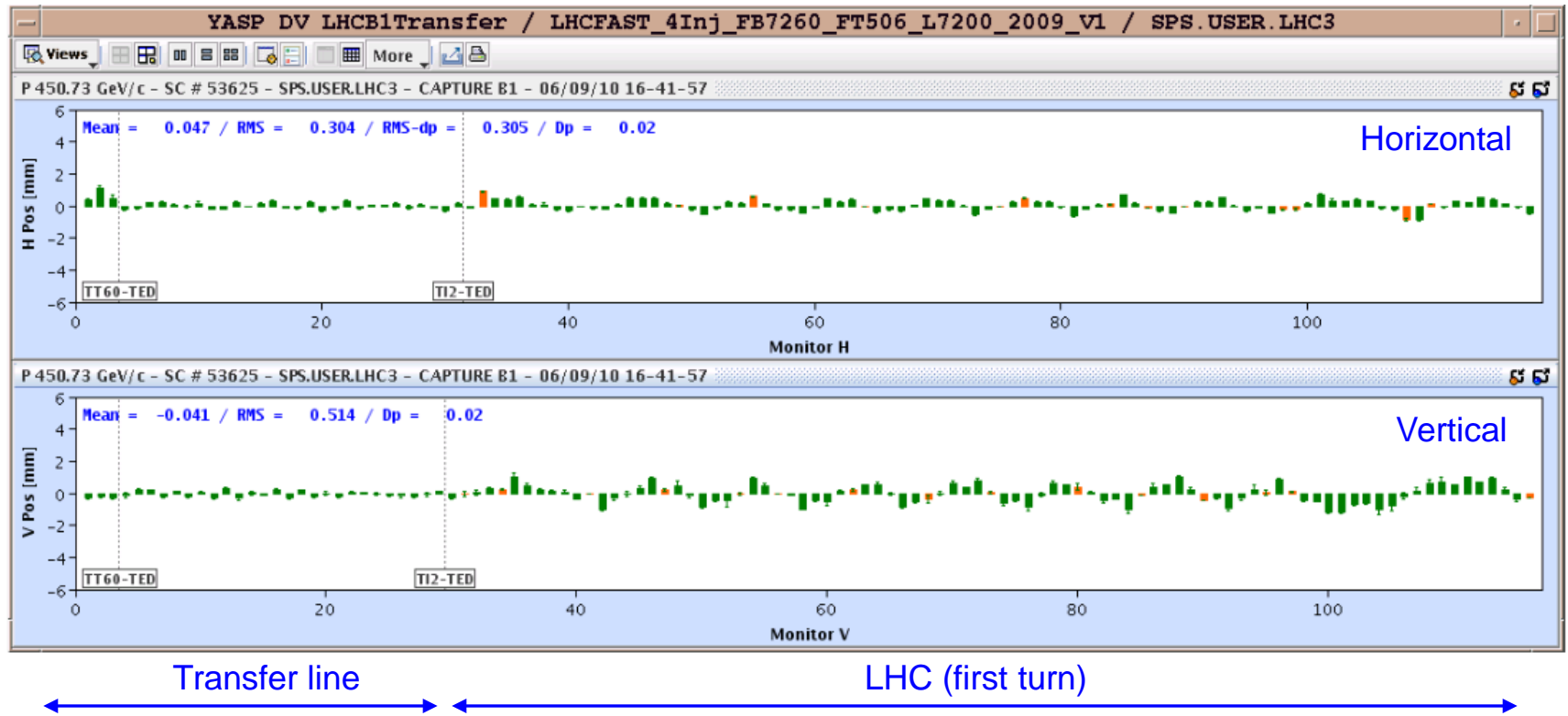



# Injection errors

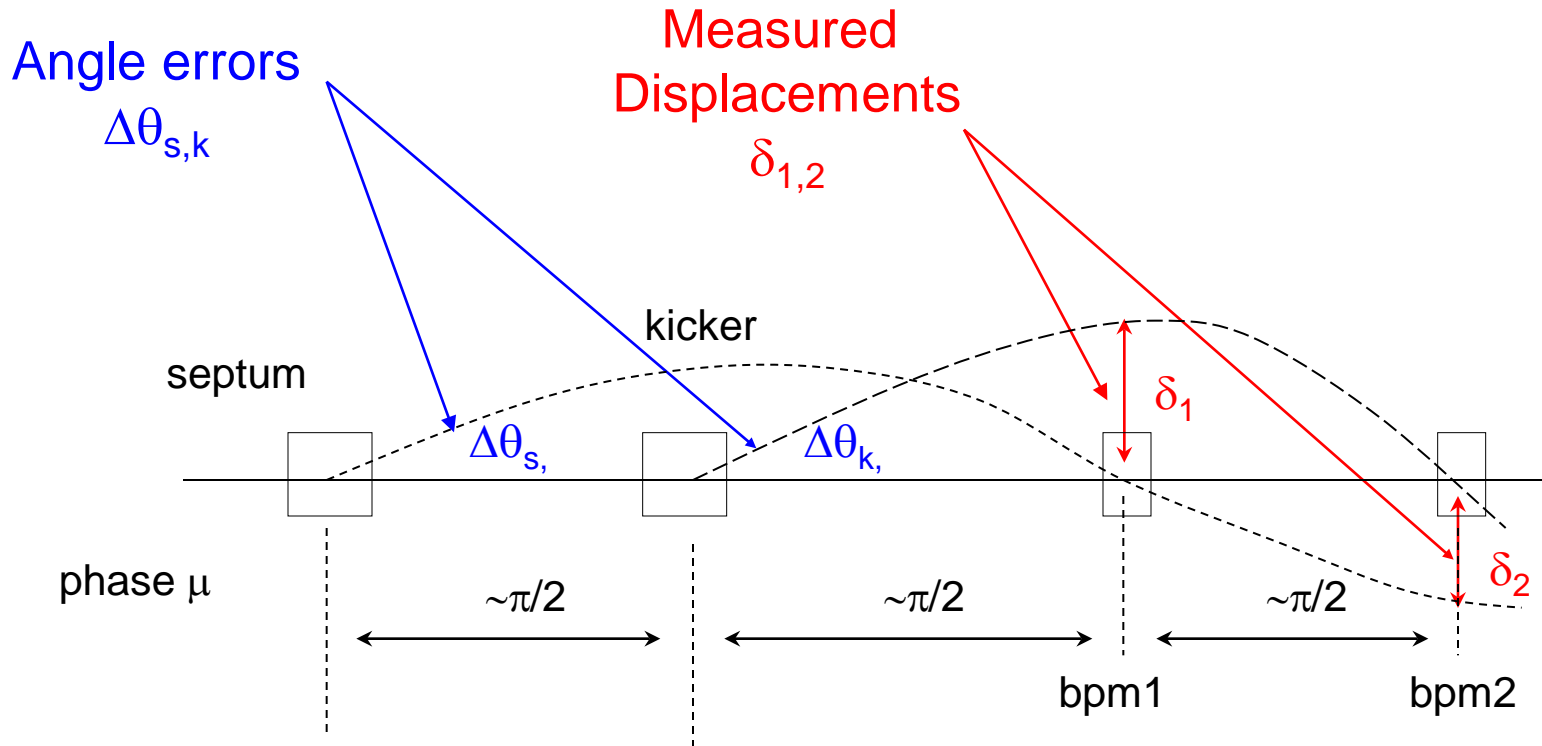

$$\delta_1 = \Delta\theta_s \sqrt{(\beta_s\beta_1)} \sin(\mu_1 - \mu_s) + \Delta\theta_k \sqrt{(\beta_k\beta_1)} \sin(\mu_1 - \mu_k)$$

$$\approx \Delta\theta_k \sqrt{(\beta_k\beta_1)}$$

$$\delta_2 = \Delta\theta_s \sqrt{(\beta_s\beta_2)} \sin(\mu_2 - \mu_s) + \Delta\theta_k \sqrt{(\beta_k\beta_2)} \sin(\mu_2 - \mu_k)$$

$$\approx -\Delta\theta_s \sqrt{(\beta_s\beta_2)}$$

# Filamentation

- Non-linear effects (e.g. magnetic field multipoles ) present which introduce amplitude dependent effects into particle motion.
- Over many turns, a phase-space oscillation is transformed into an emittance increase.
- So any residual transverse oscillation will lead to an emittance blow-up through filamentation
  - “Transverse damper” systems used to damp injection oscillations - bunch position measured by a pick-up, which is linked to a kicker

# Filamentation

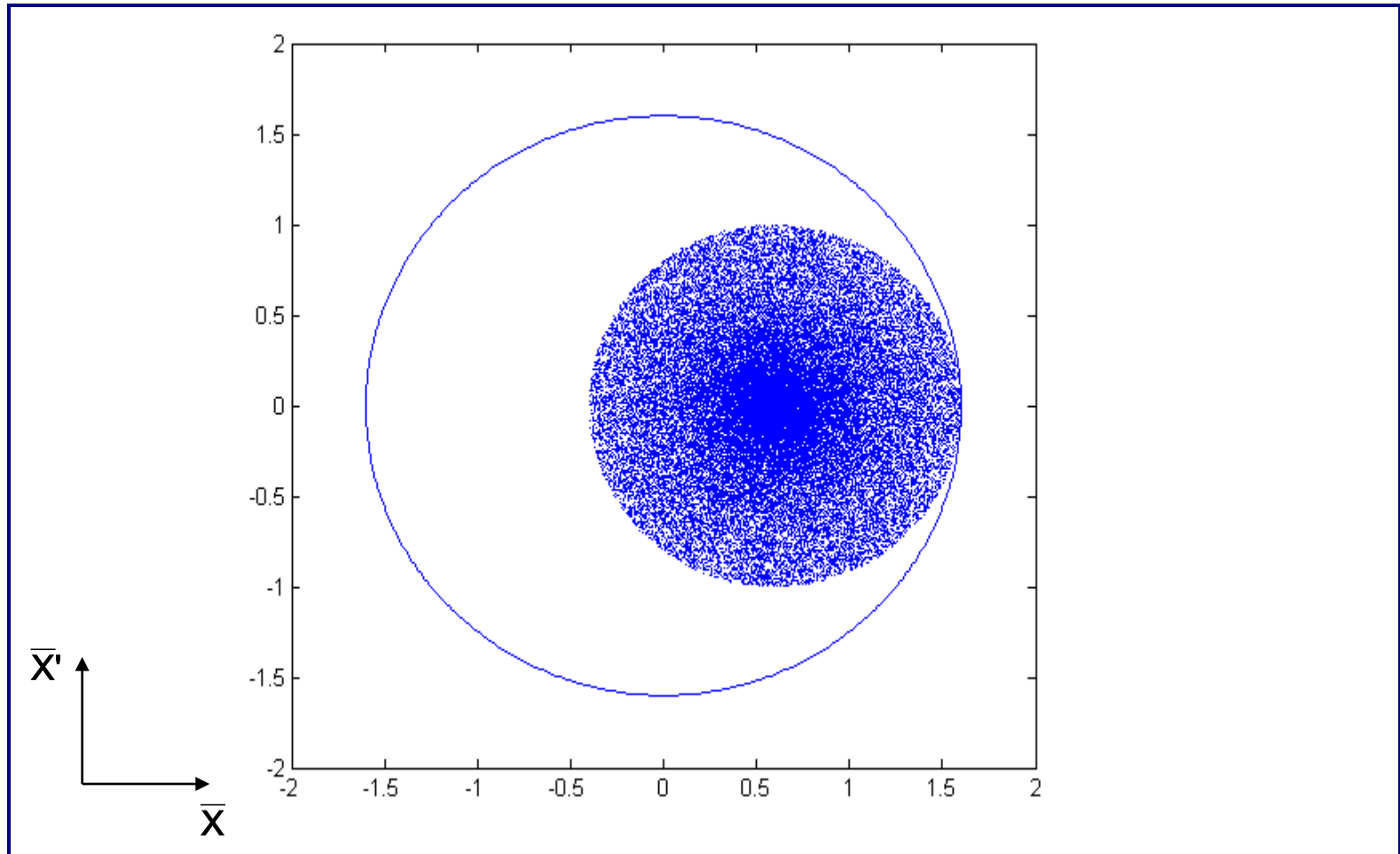

# Filamentation

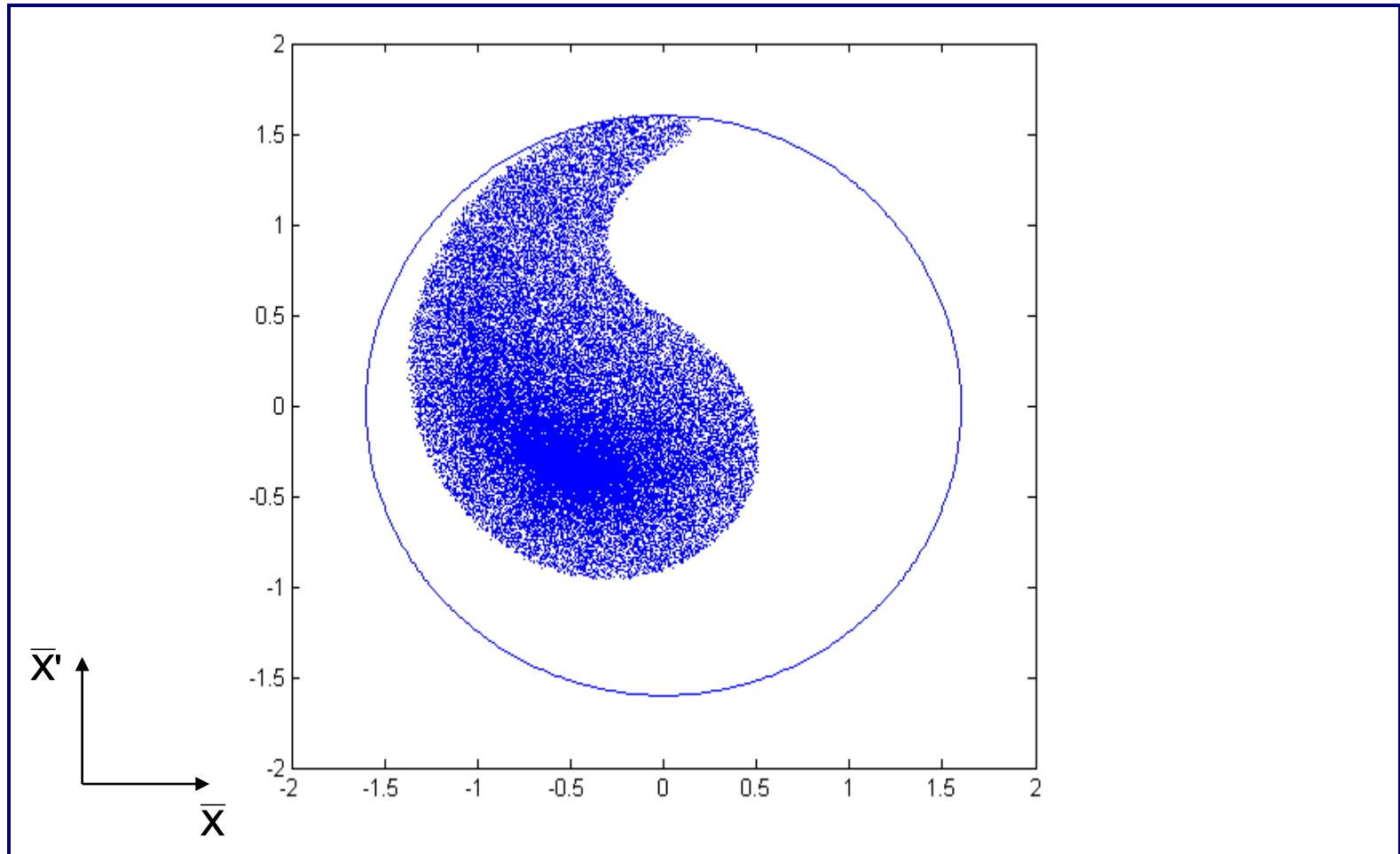

# Filamentation

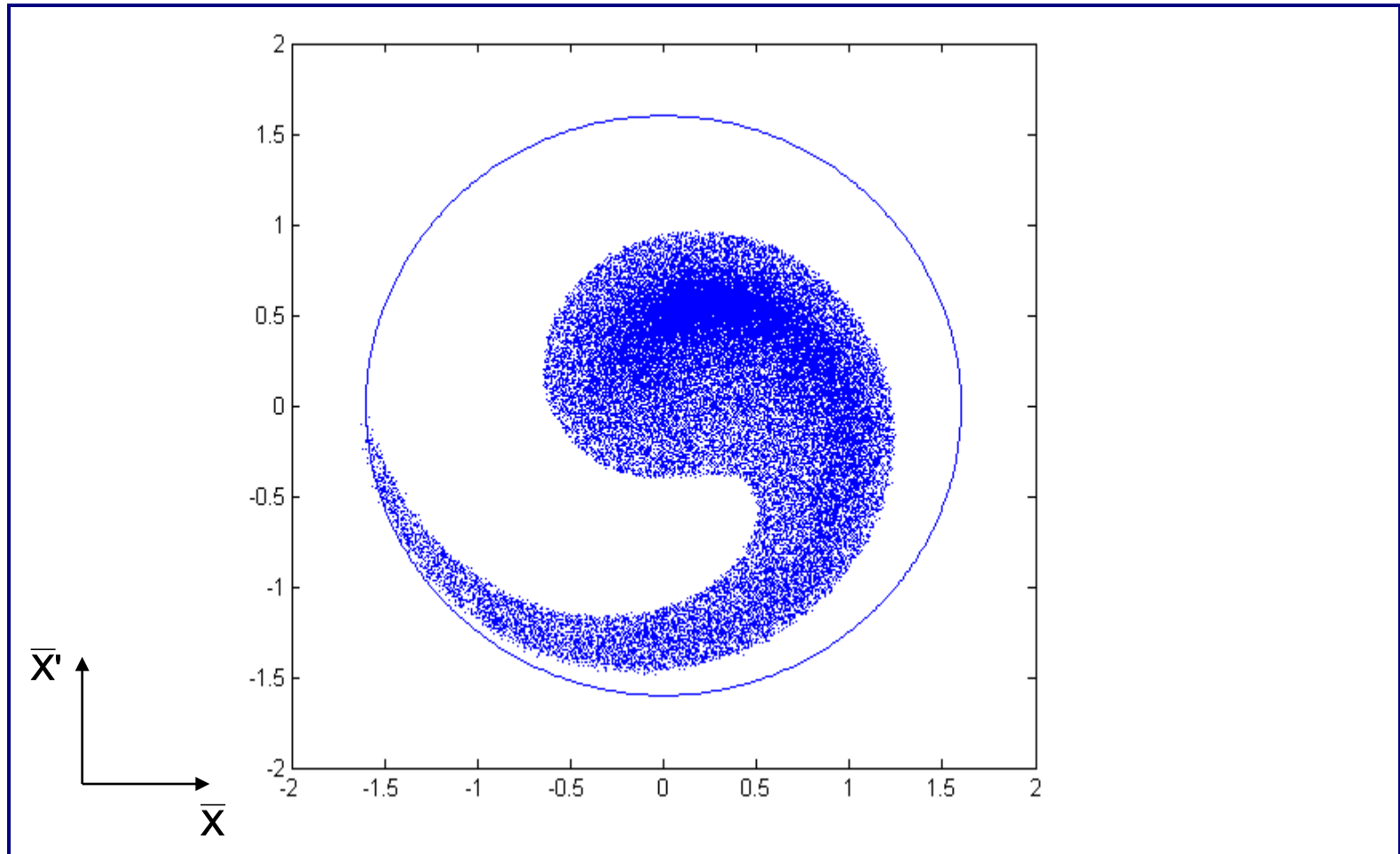

# Filamentation

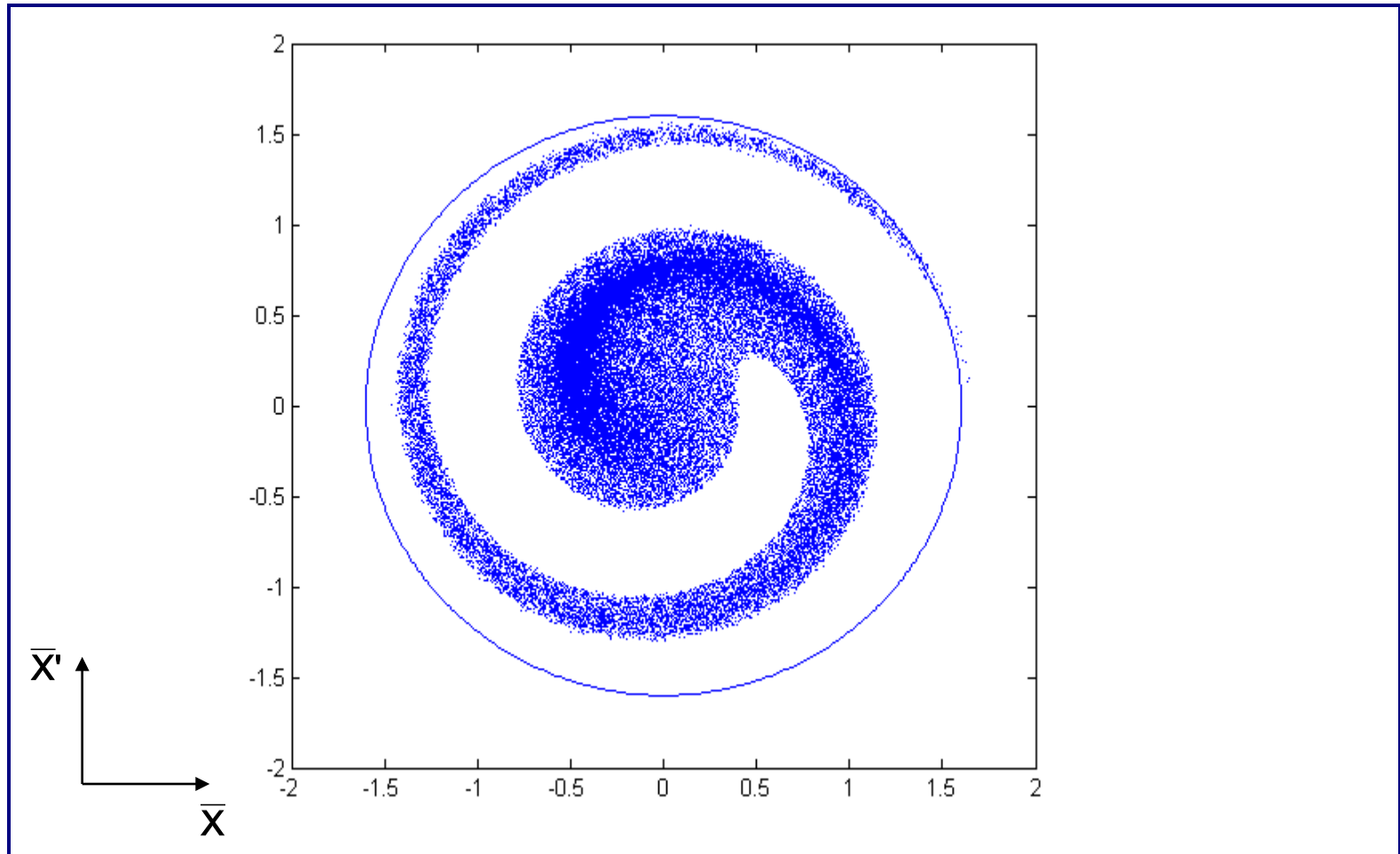

# Filamentation

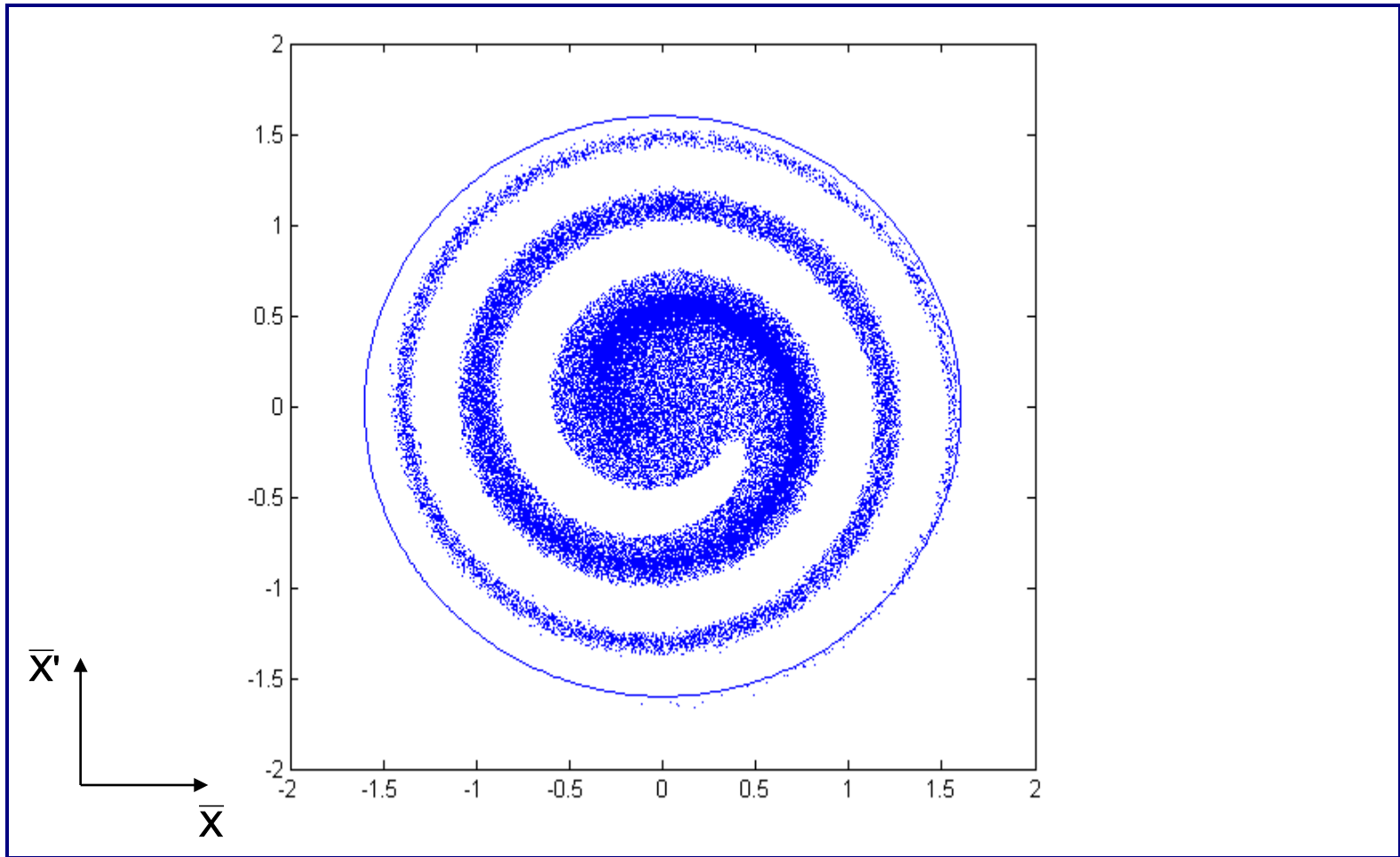

# Filamentation

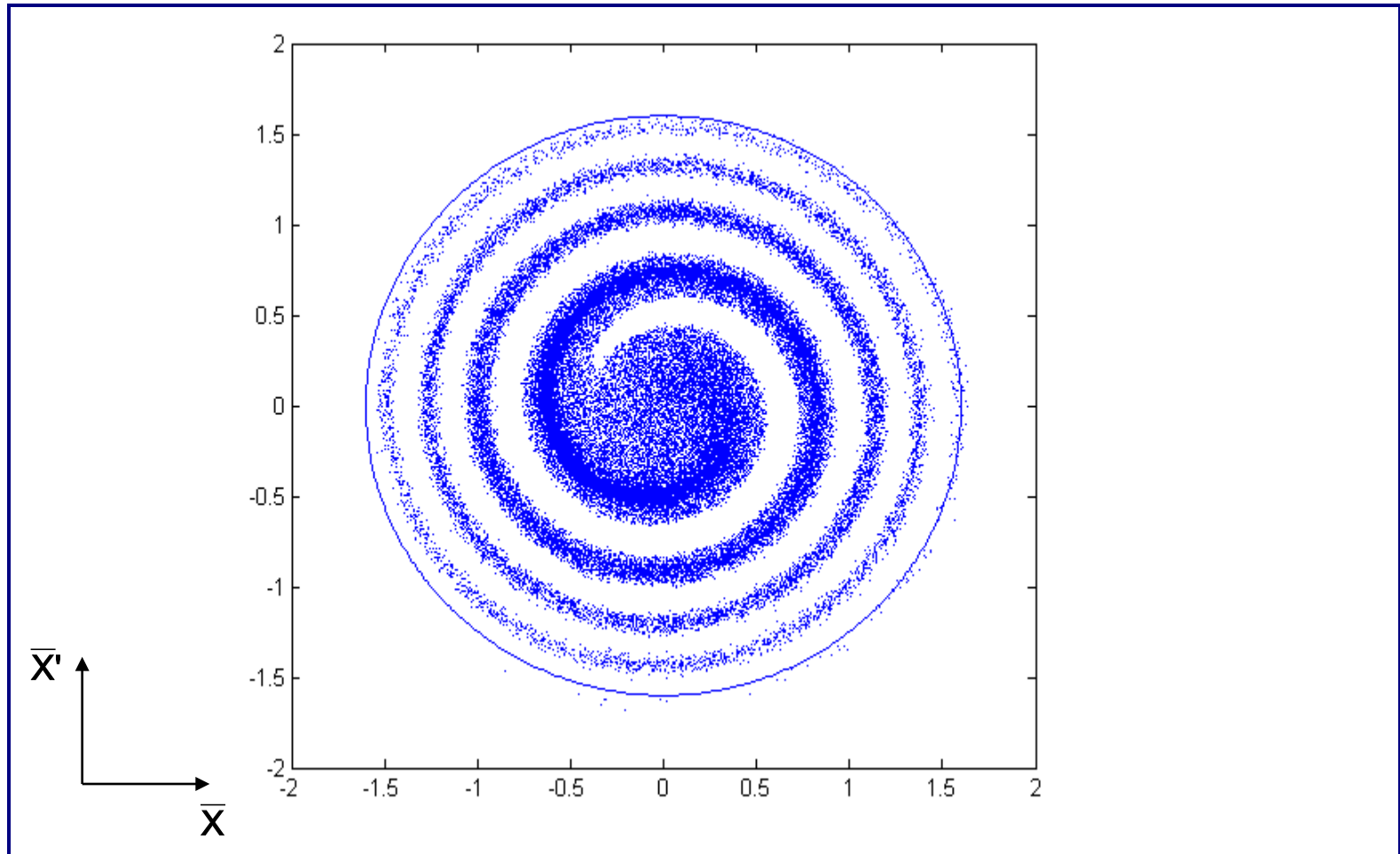



# Filamentation

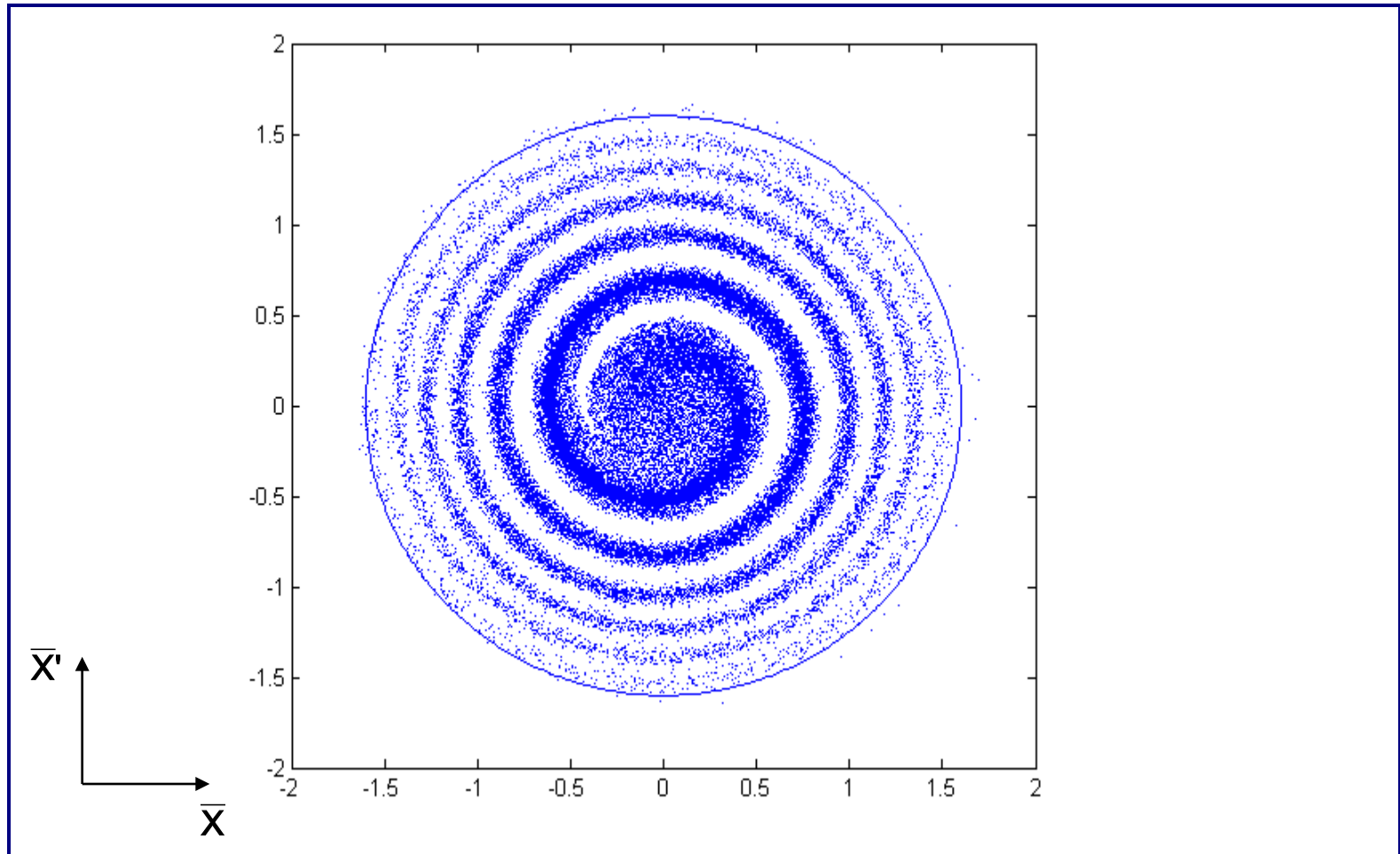

# Filamentation

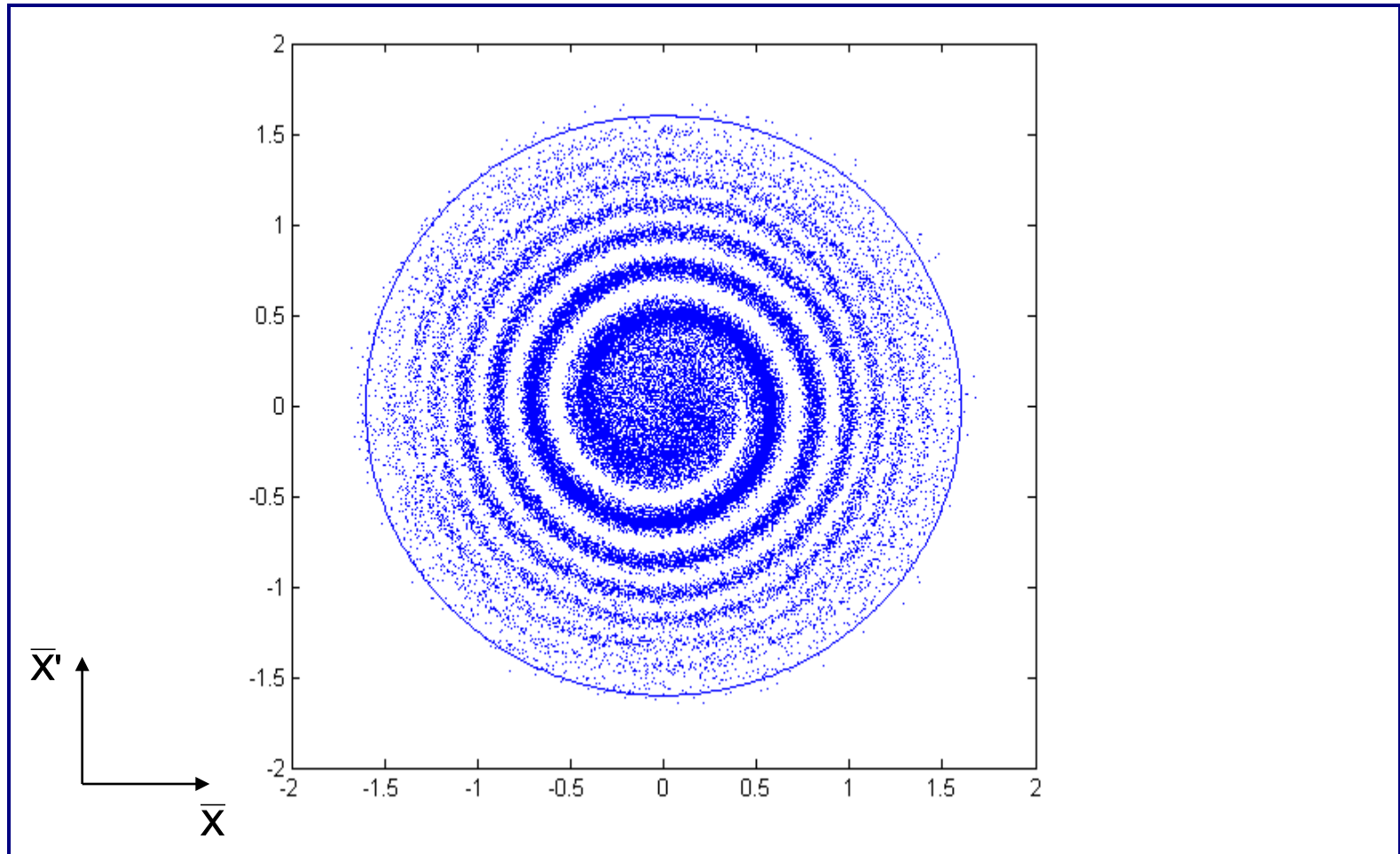

# Filamentation

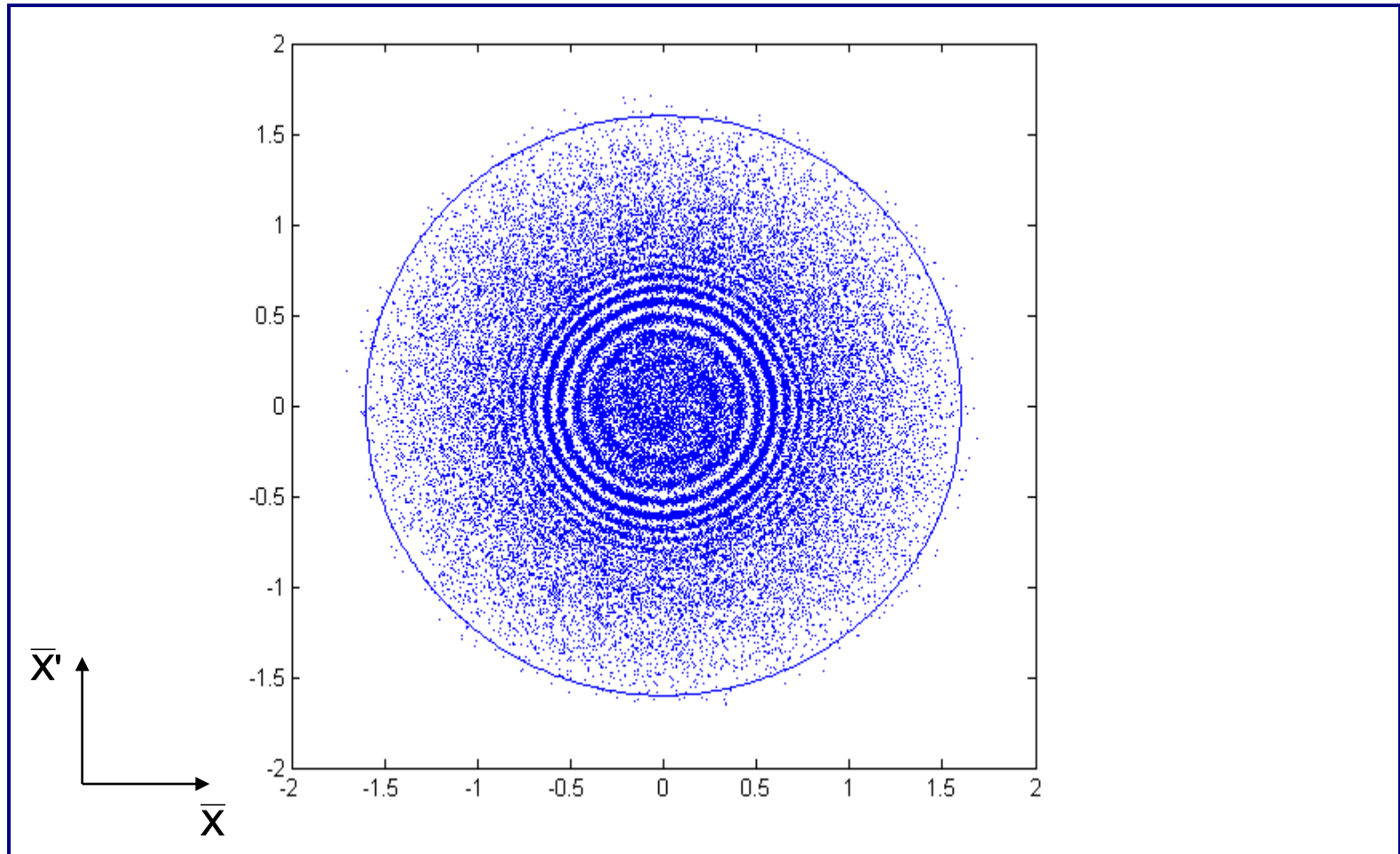

# Filamentation

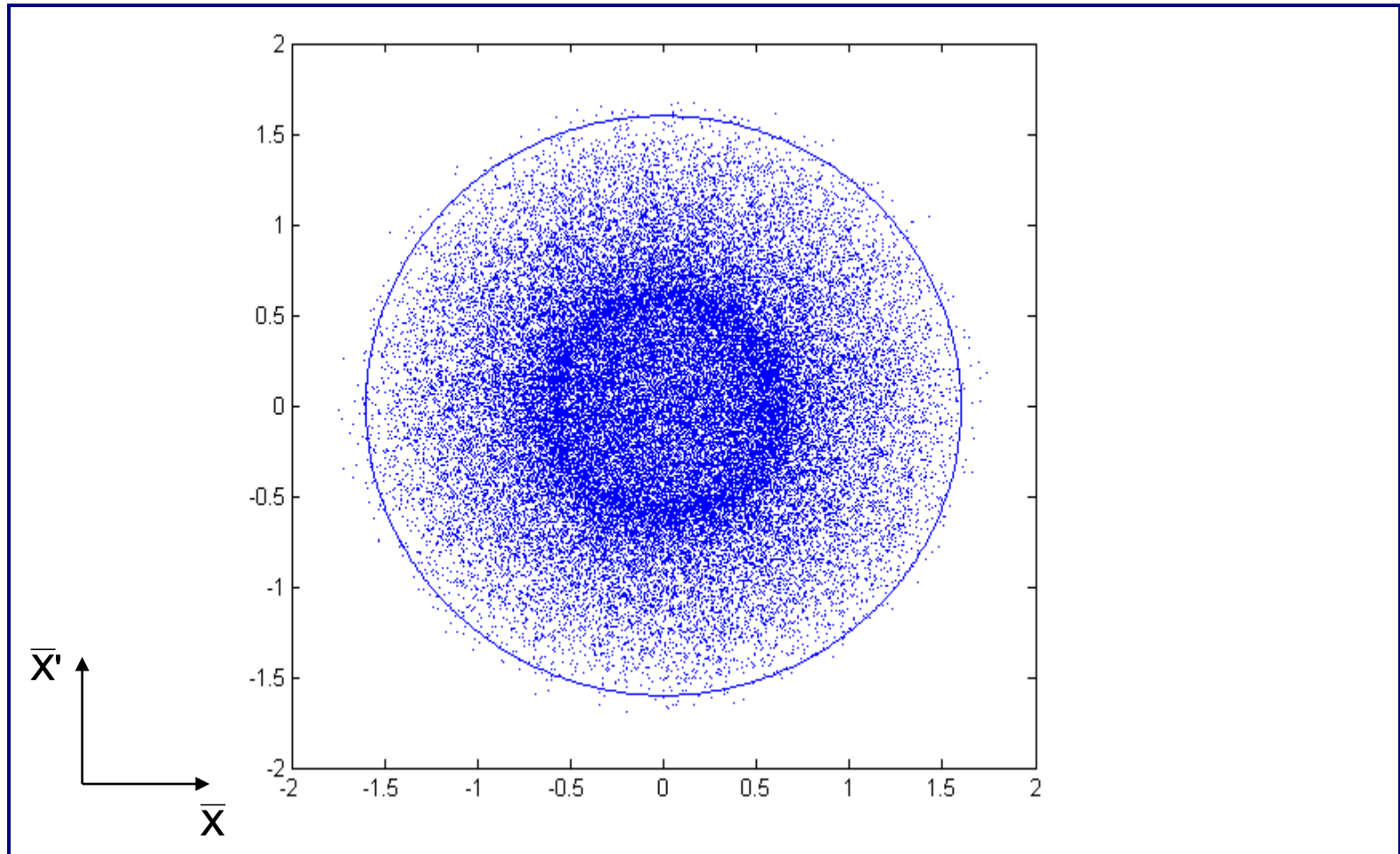

# Damping of injection oscillations

- Residual transverse oscillations lead to an emittance blow-up through filamentation
- “Transverse damper” systems used to damp injection oscillations - bunch position measured by a pick-up, which is linked to a kicker
- Damper measures offset of bunch on one turn, then kicks the bunch on a subsequent turn to reduce the oscillation amplitude

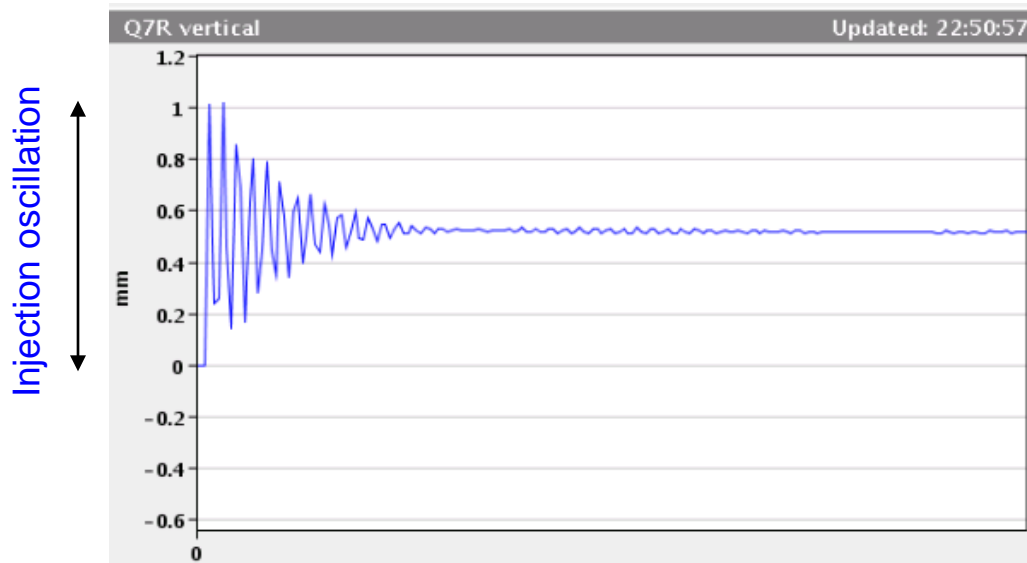

# Optical Mismatch at Injection

- Can also have an emittance blow-up through optical mismatch
- Individual particles oscillate with conserved CS invariant:

$$a_x = \gamma x^2 + 2\alpha xx' + \beta x'^2$$

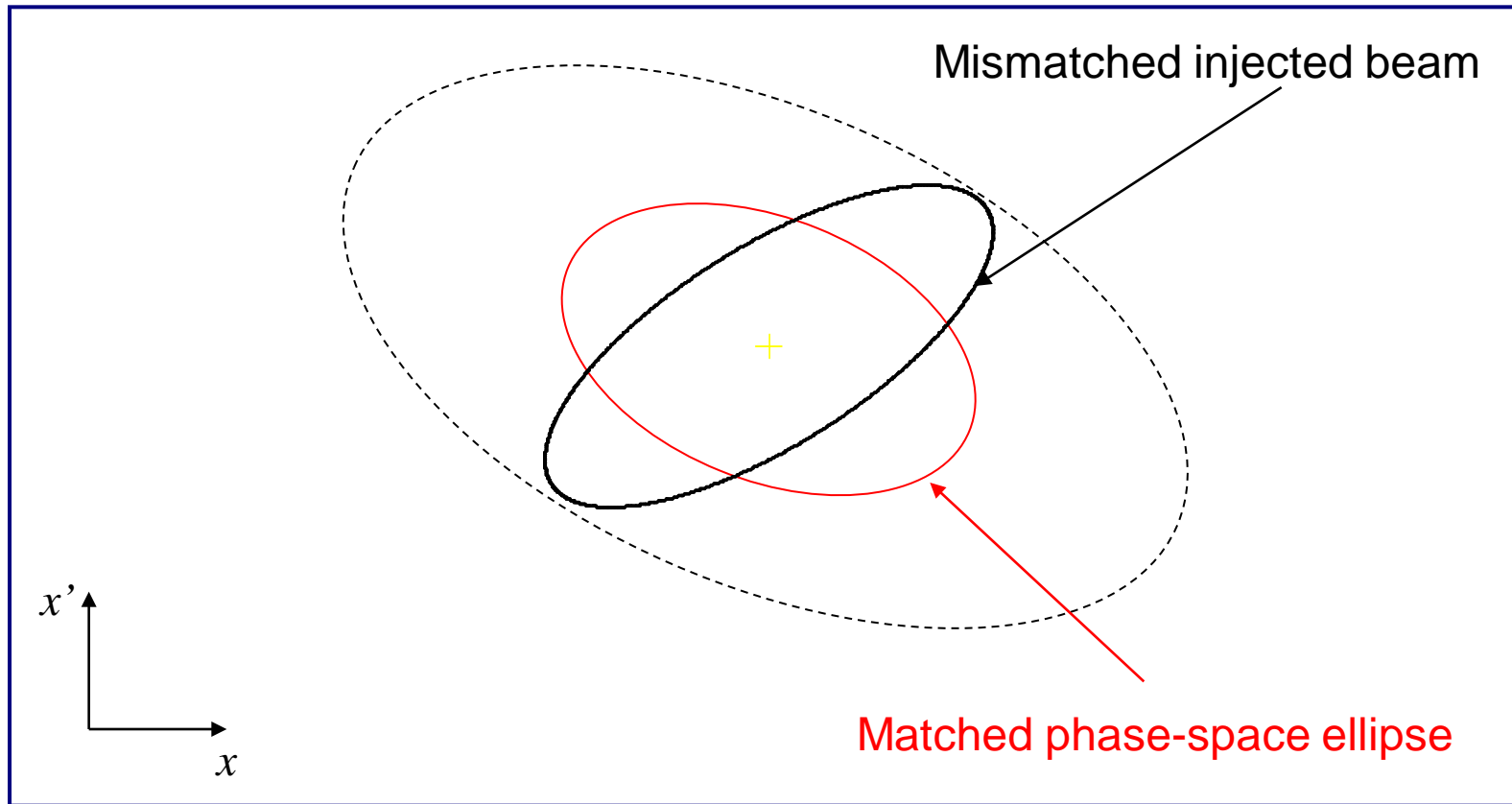

# Optical Mismatch at Injection

- Filamentation fills larger ellipse with same shape as matched ellipse

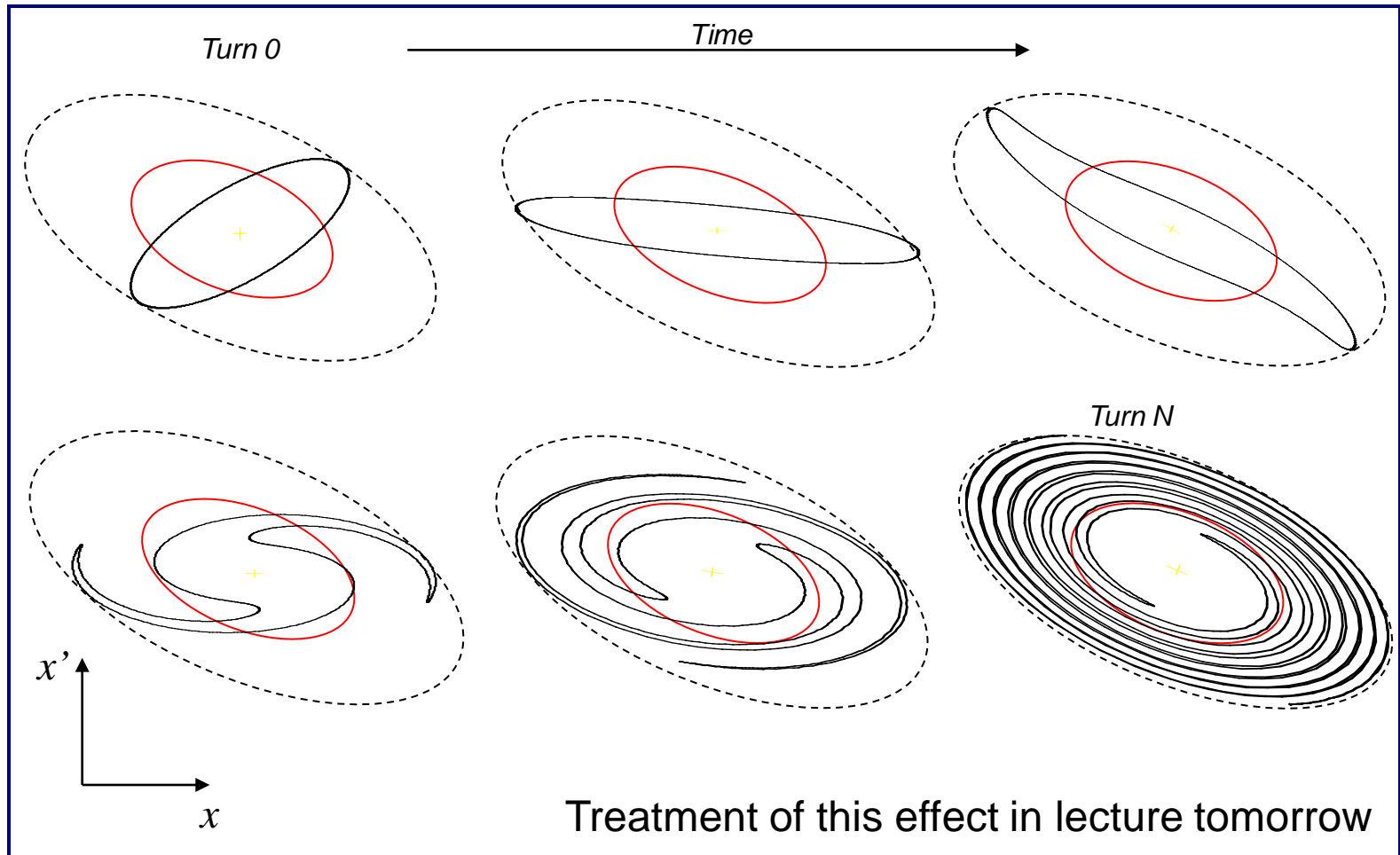

# Multi-turn injection

- For hadrons the beam density at injection can be limited either by space charge effects or by the injector capacity
- If we cannot increase charge density, we can sometimes fill the horizontal phase space to increase overall injected intensity.
  - Condition that the acceptance of receiving machine is larger than the delivered beam emittance



# Multi-turn injection for hadrons

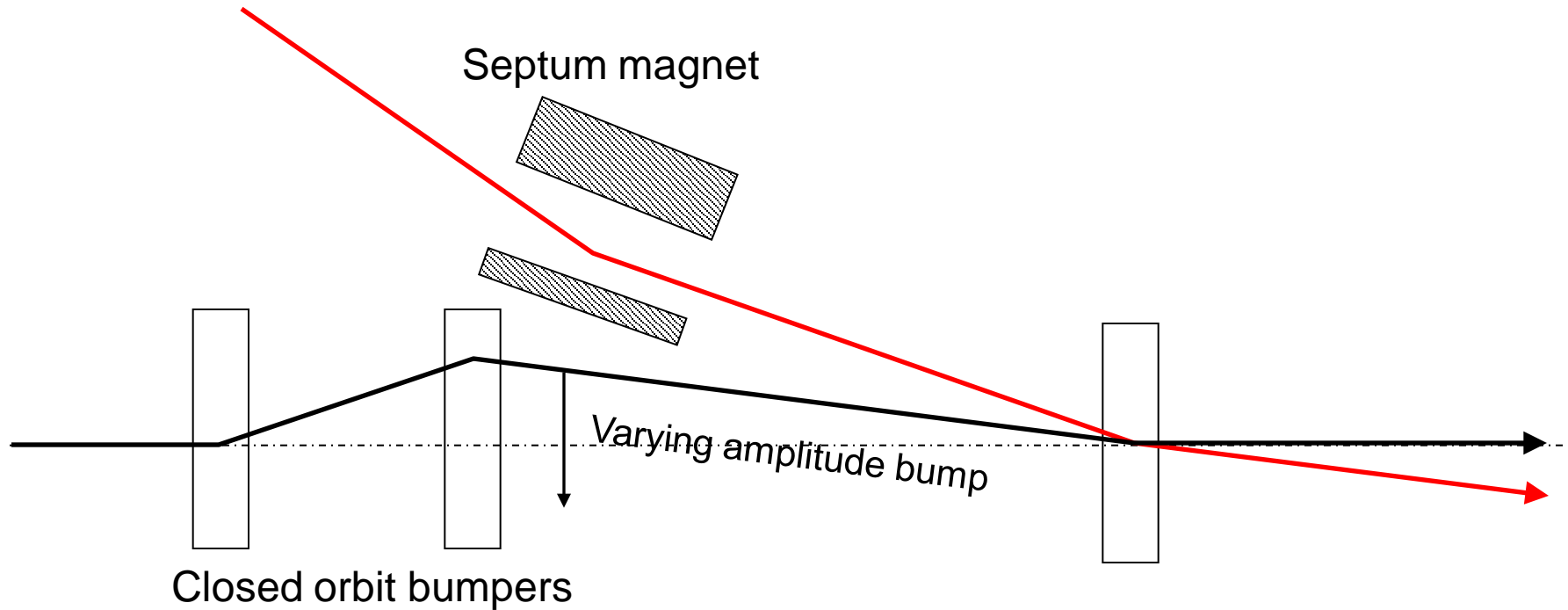

- No kicker
- Bump amplitude decreases and inject a new bunch at each turn
- Phase-space “painting”

# Multi-turn injection for hadrons

Example: CERN PSB injection, fractional tune  $Q_h = 0.25$   
Beam rotates  $\pi/2$  per turn in phase space

Turn 1

On each turn inject a  
new batch and reduce  
the bump amplitude

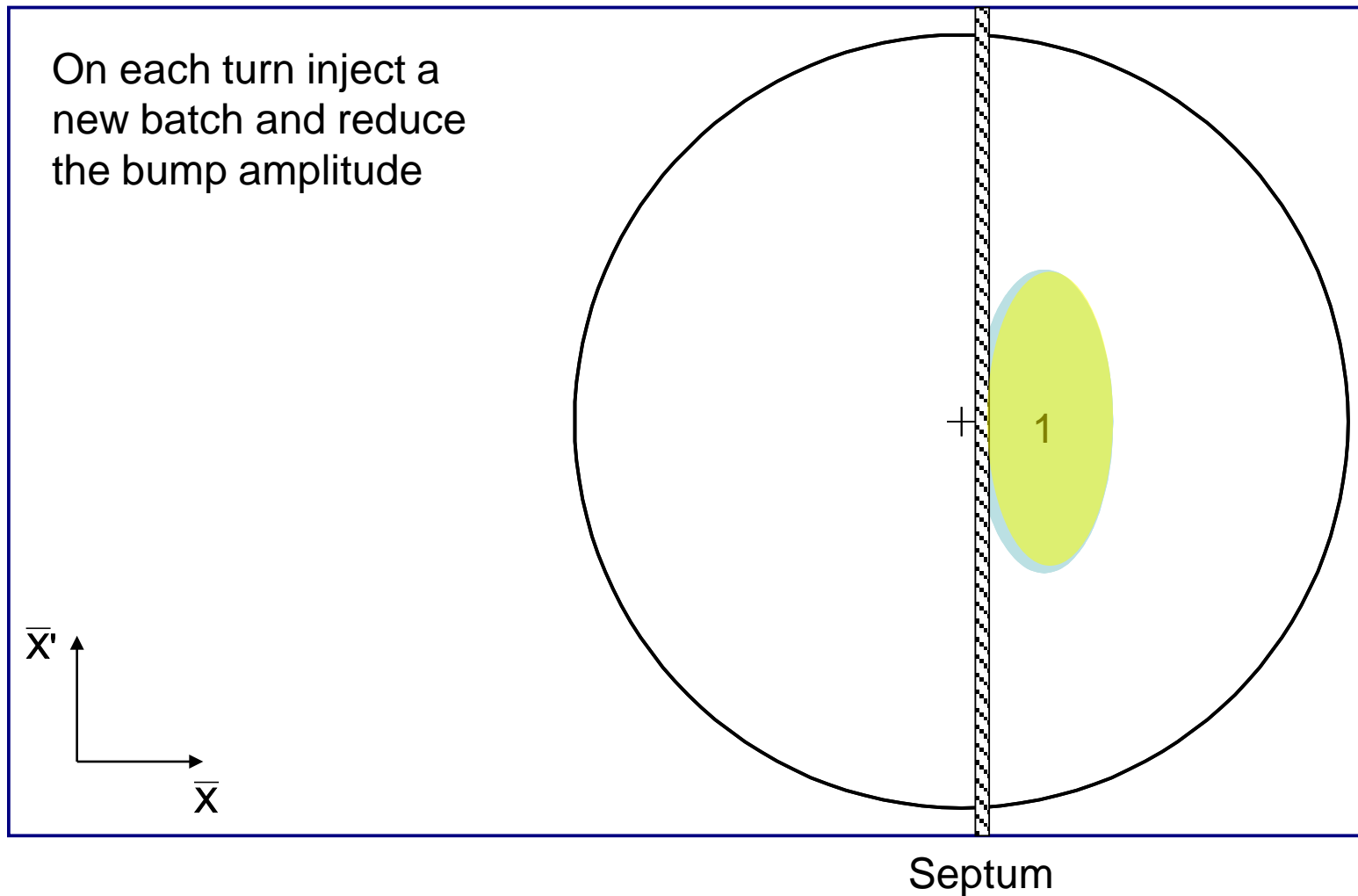

# Multi-turn injection for hadrons

Turn 2

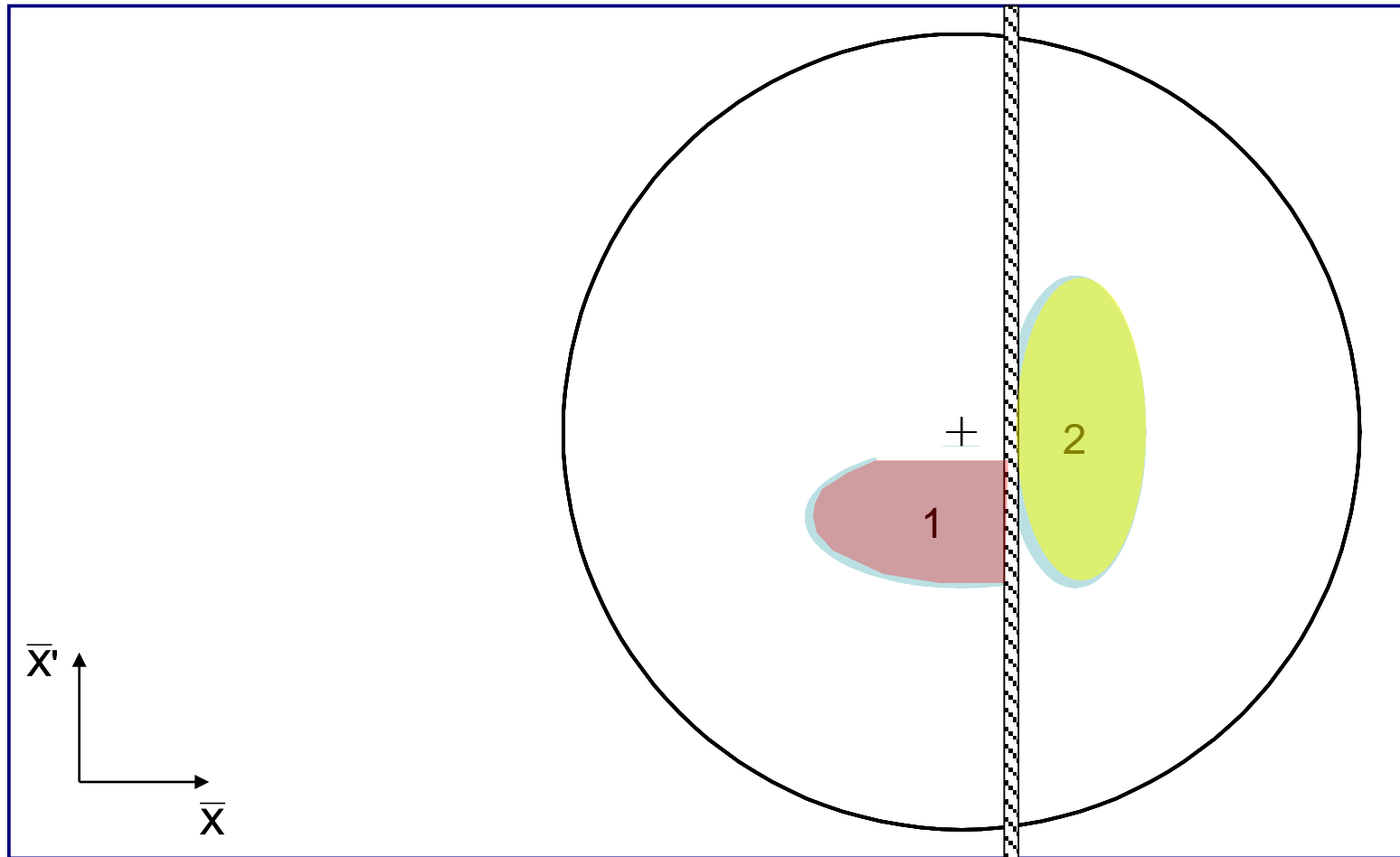

# Multi-turn injection for hadrons

Turn 3

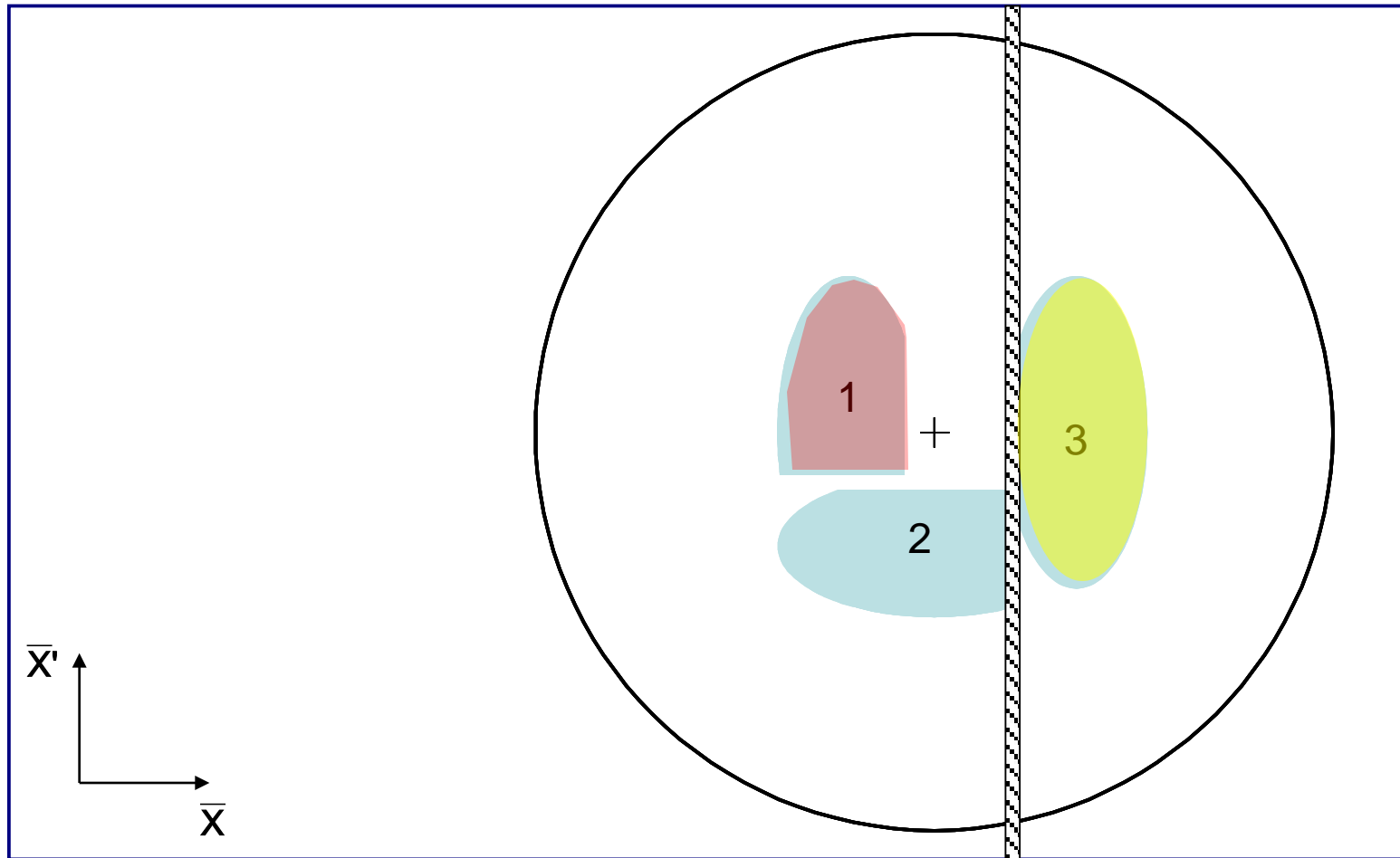

# Multi-turn injection for hadrons

Turn 4

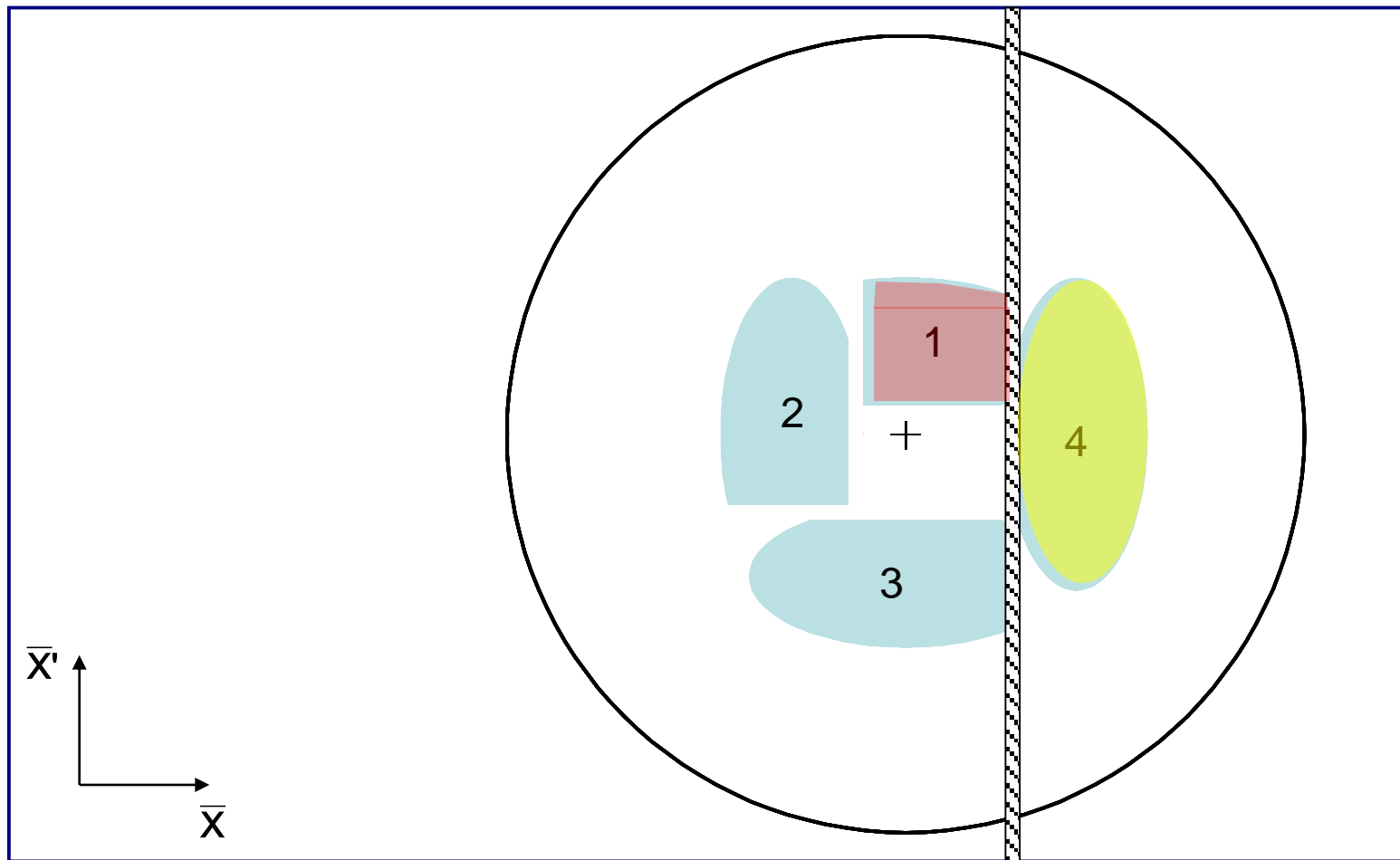

# Multi-turn injection for hadrons

Turn 5

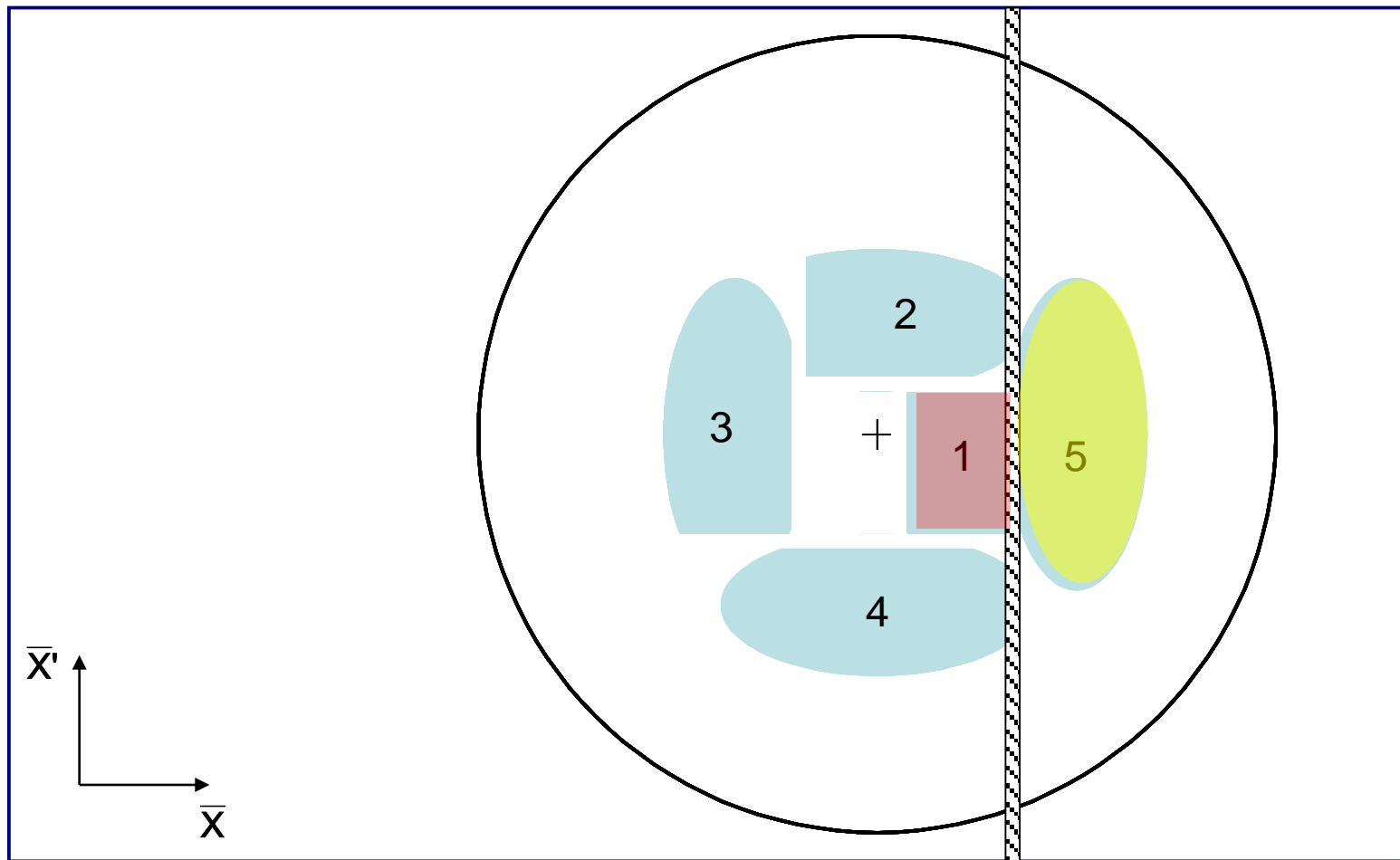

# Multi-turn injection for hadrons

Turn 6

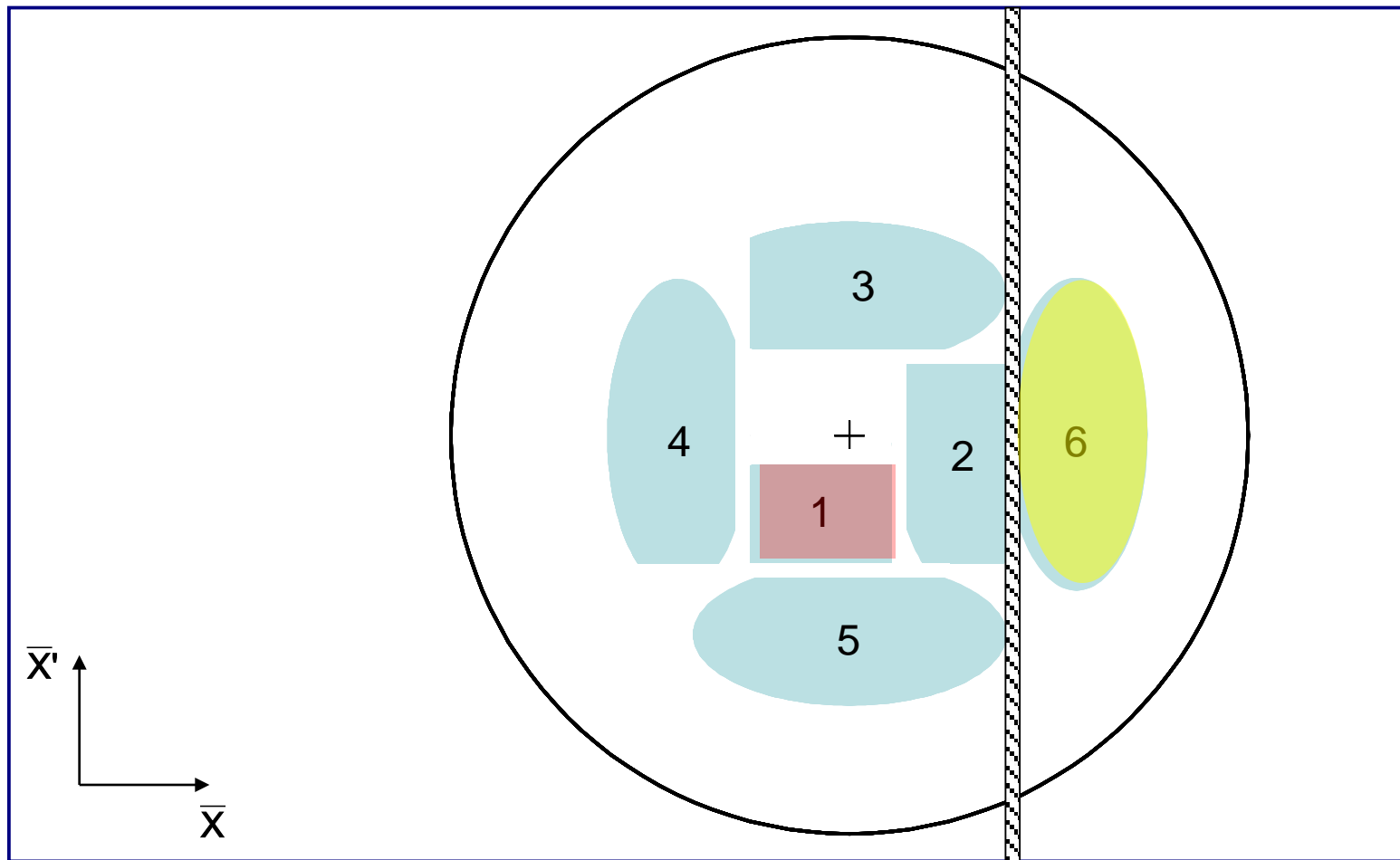

# Multi-turn injection for hadrons

Turn 7

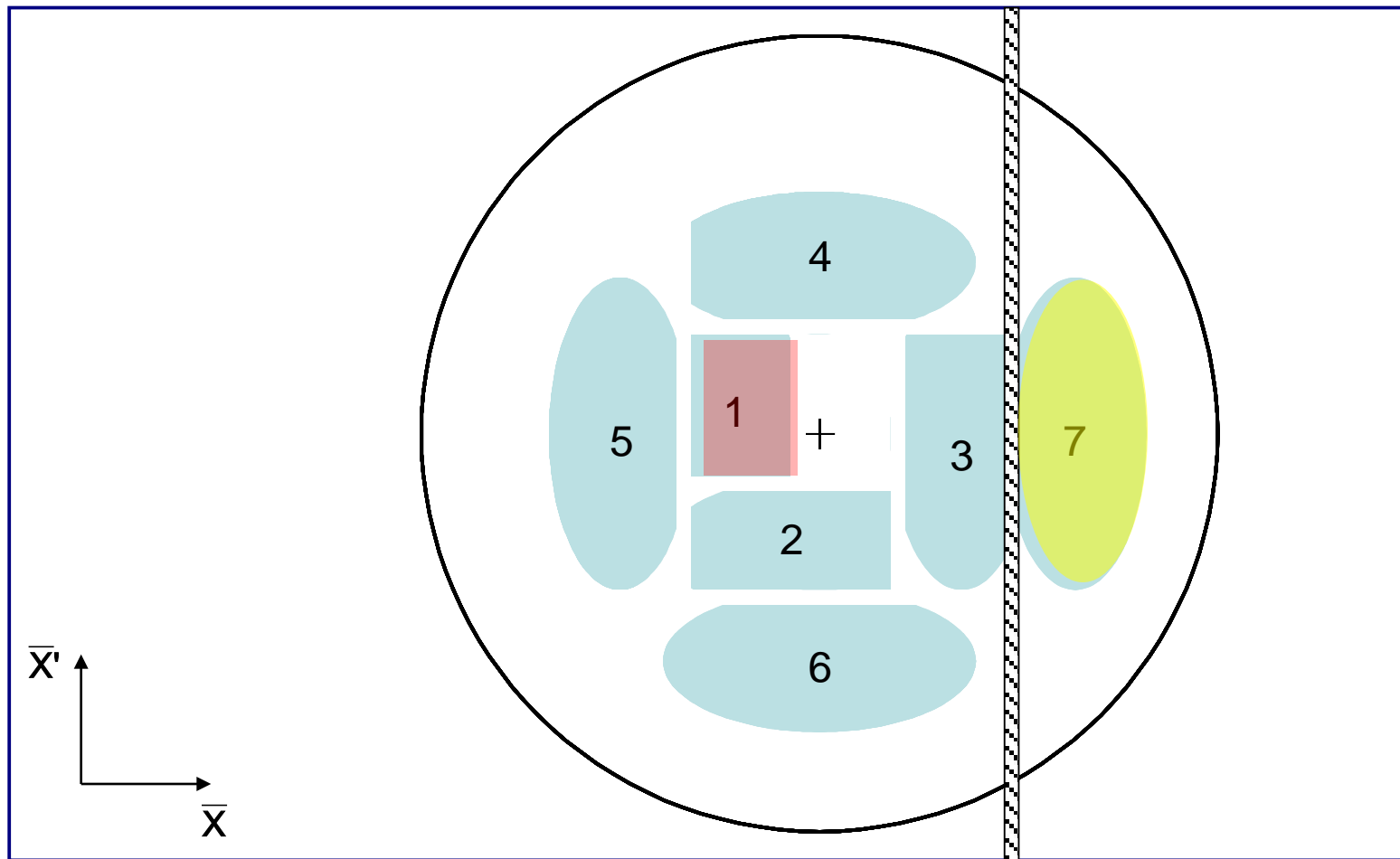



# Multi-turn injection for hadrons

Turn 8

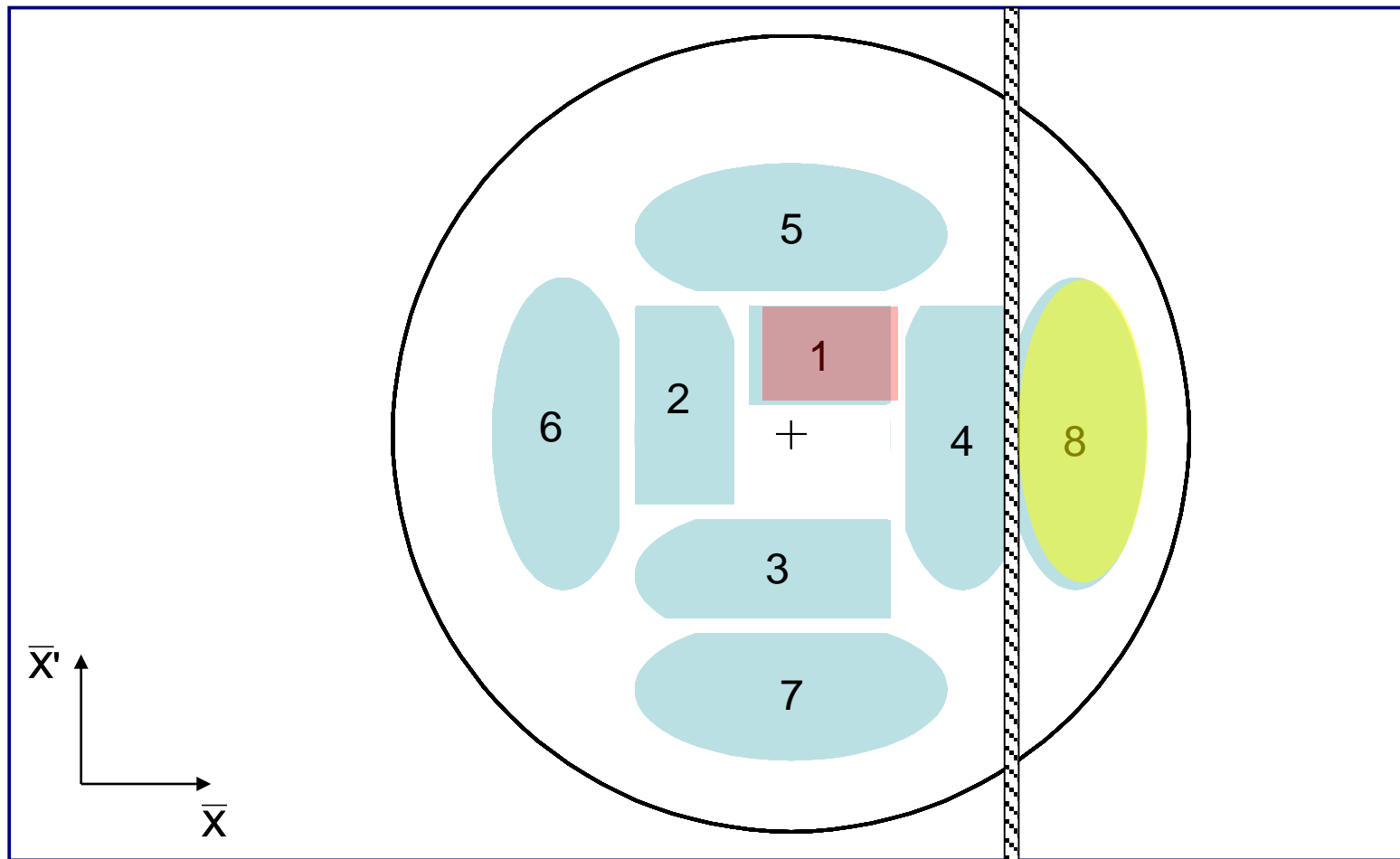

# Multi-turn injection for hadrons

Turn 9

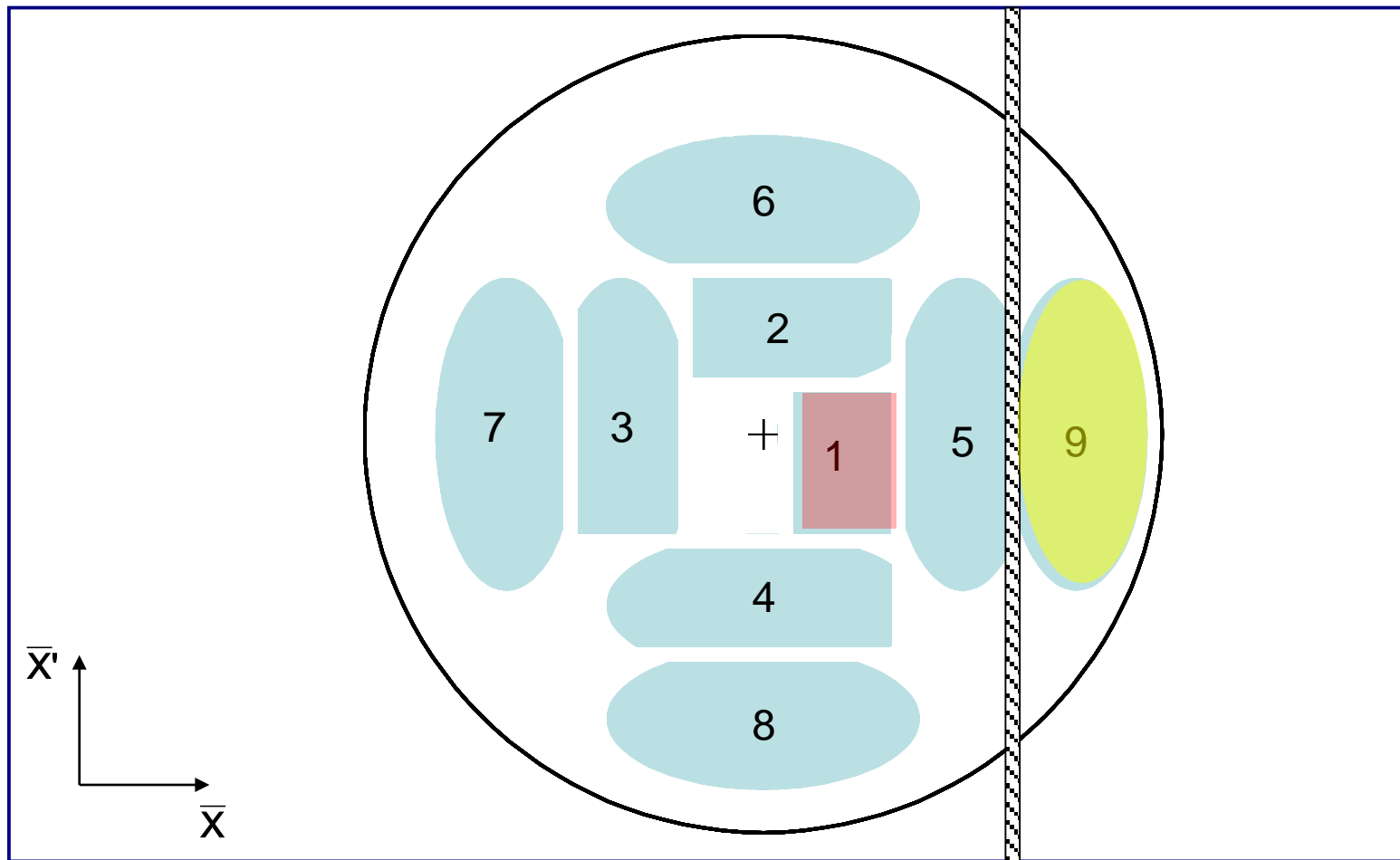

# Multi-turn injection for hadrons

Turn 10

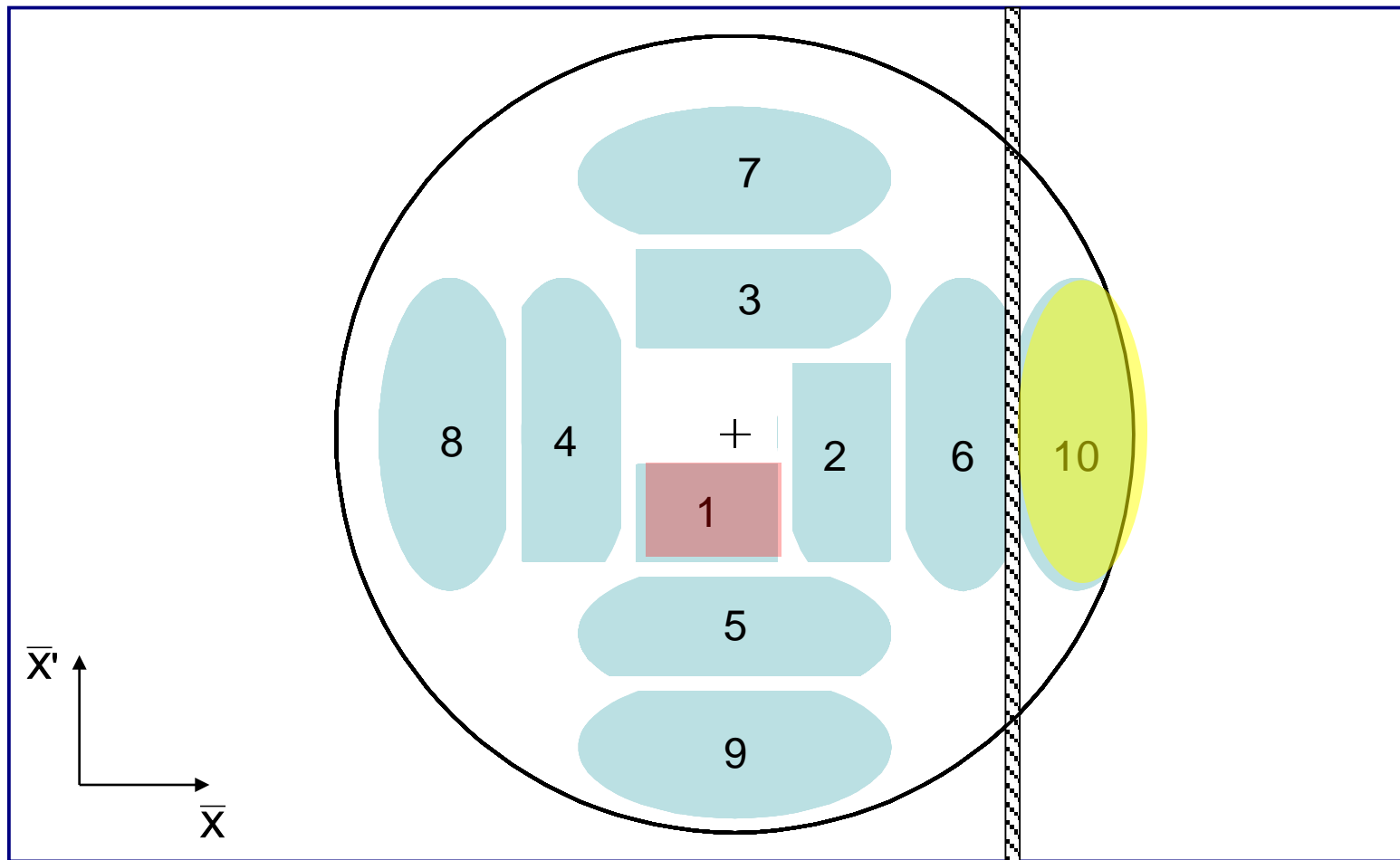

# Multi-turn injection for hadrons

Turn 11

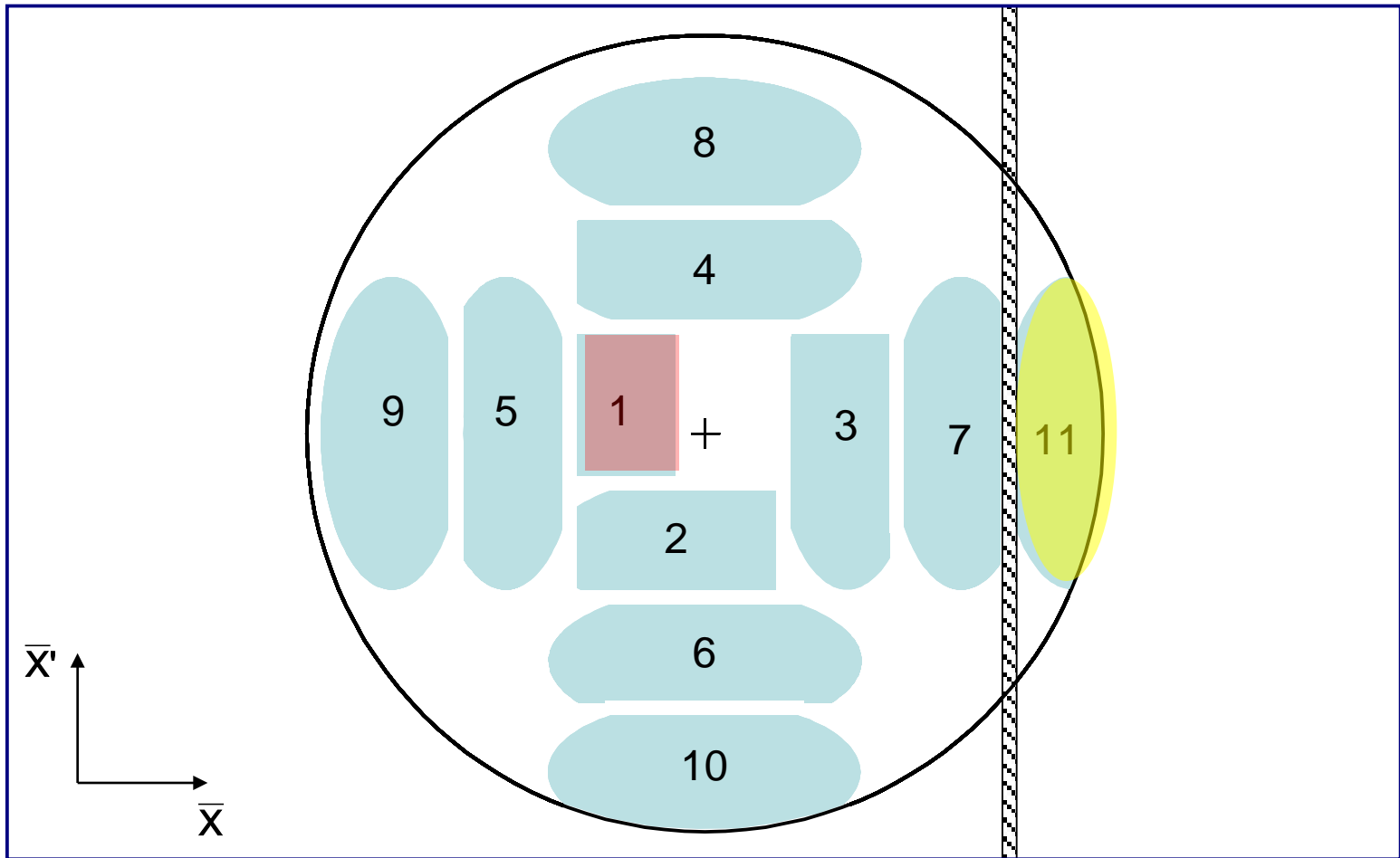

# Multi-turn injection for hadrons

Turn 12

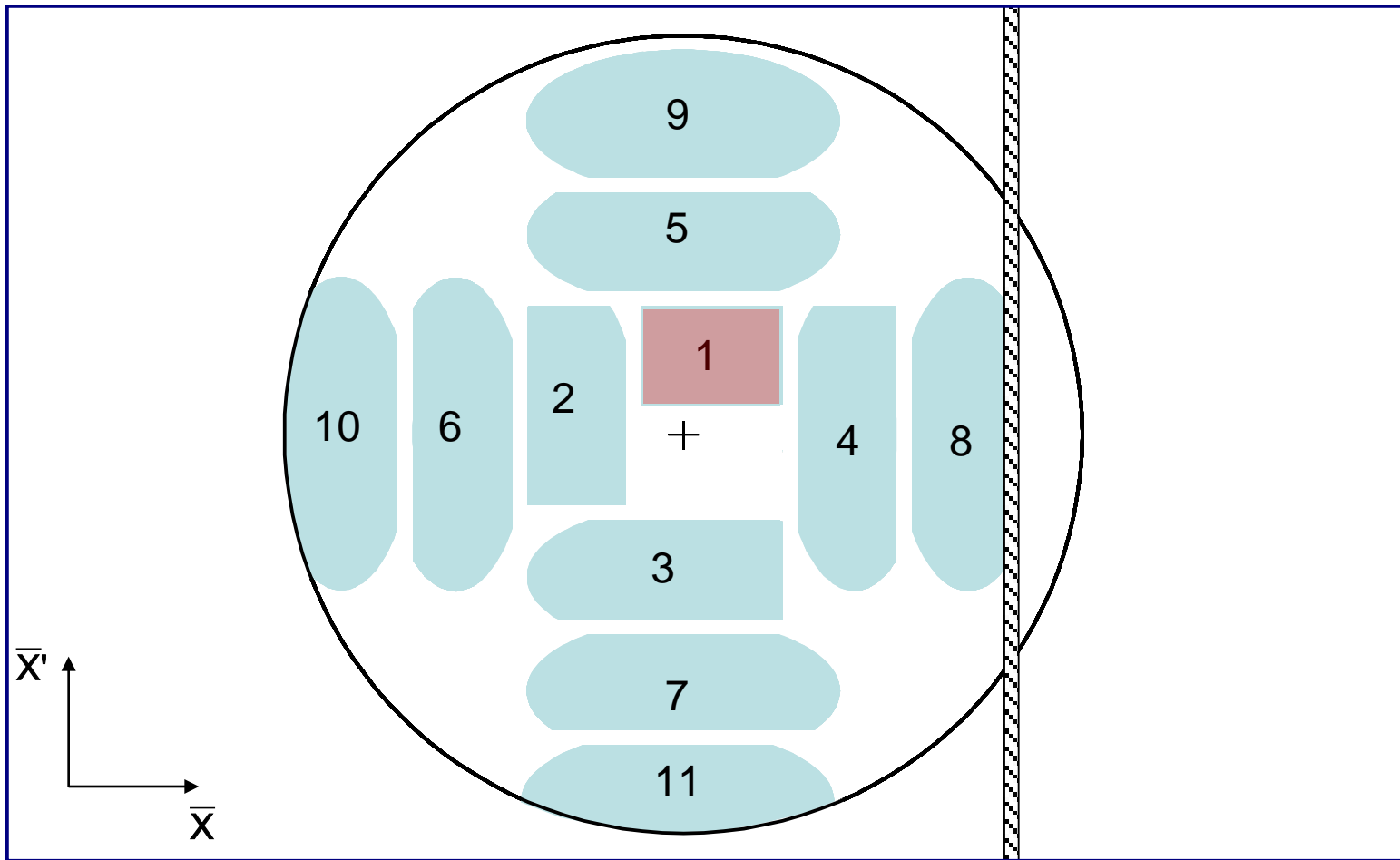

# Multi-turn injection for hadrons

Turn 13

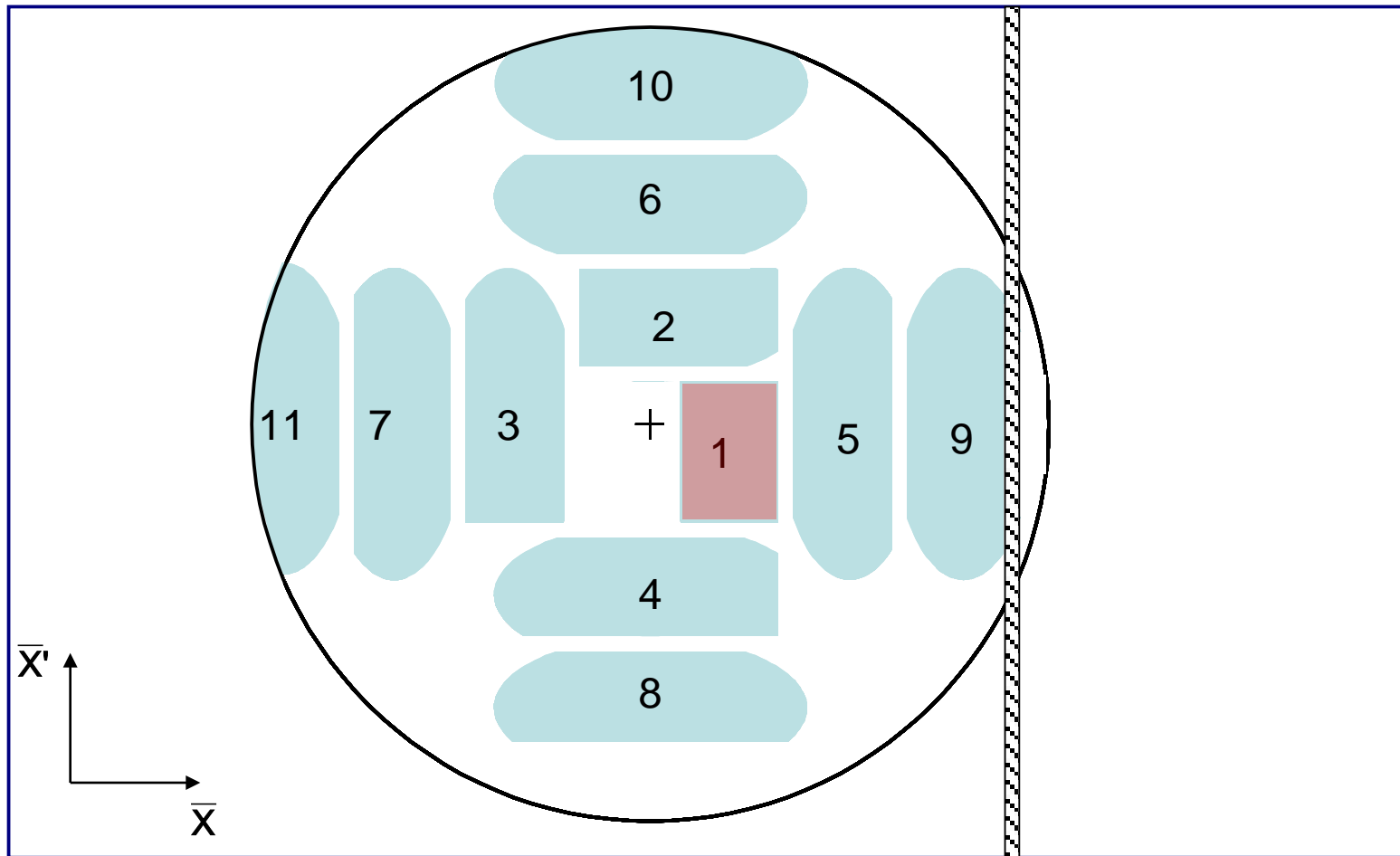

# Multi-turn injection for hadrons

Turn 14

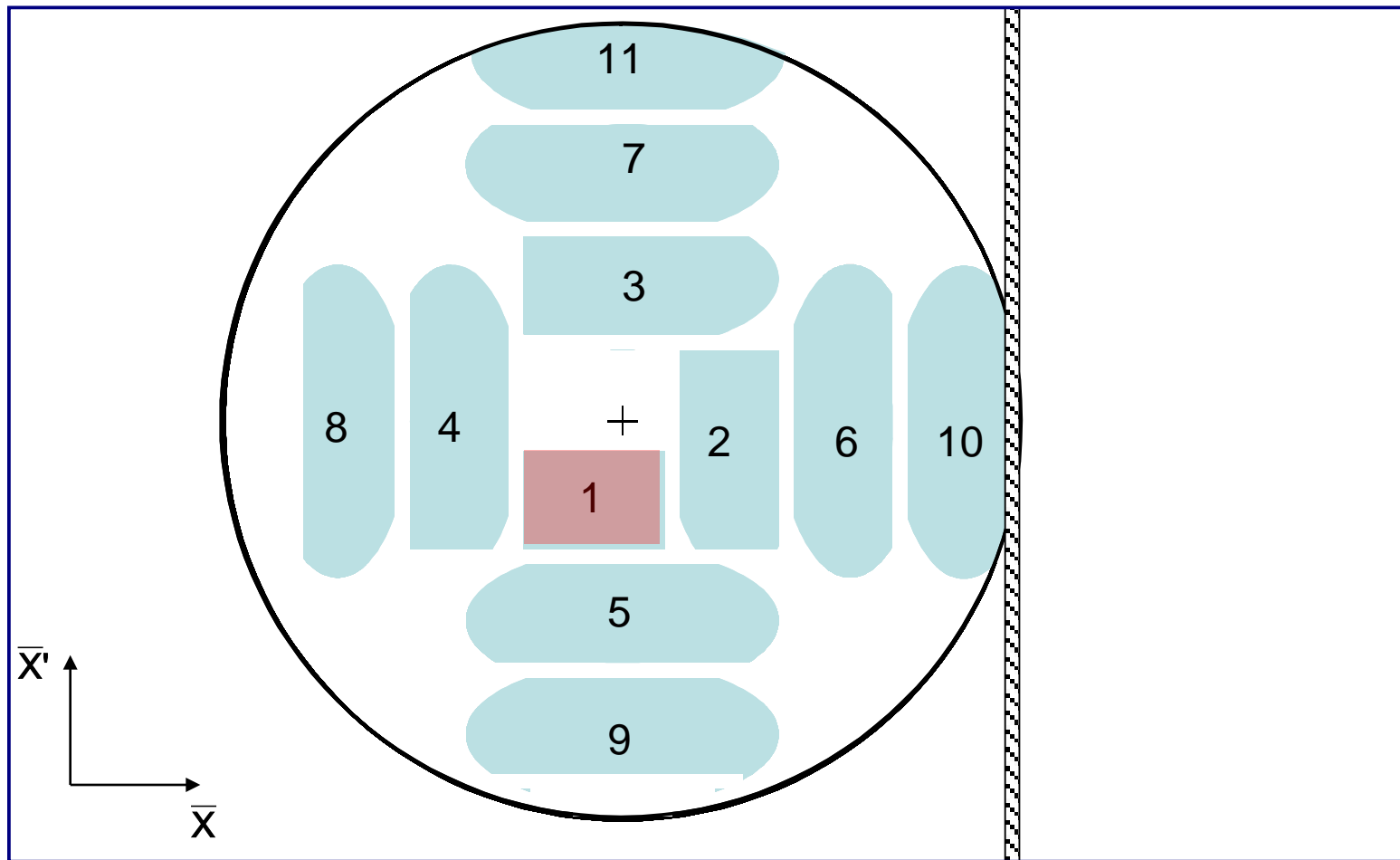

# Multi-turn injection for hadrons

Phase space has been “painted”

Turn 15

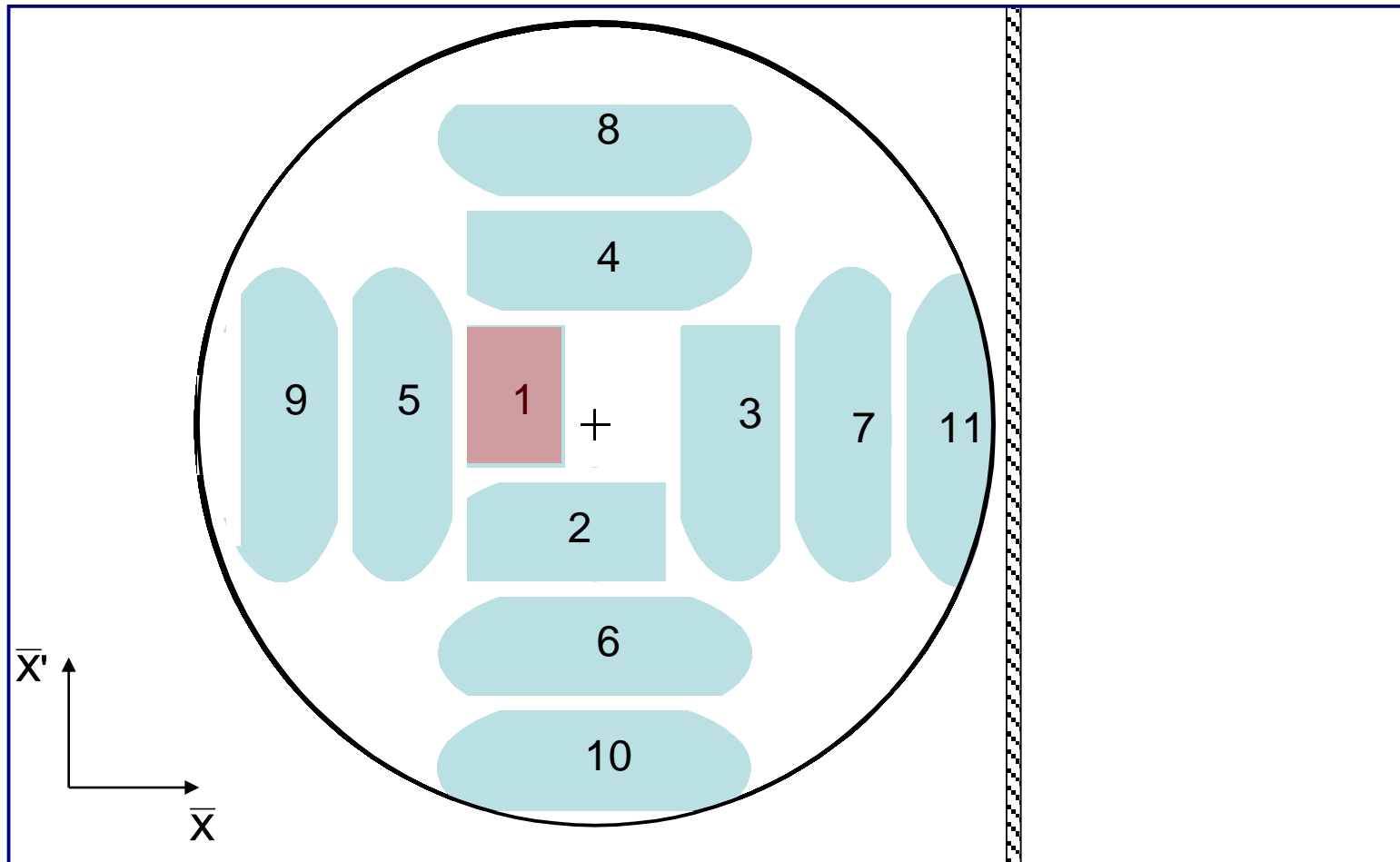

In reality filamentation occurs to produce a quasi-uniform beam



# Injection mismatch

- For multiturn injection over  $n$  turns, injected beam ellipse is deliberately mismatched to circulating beam ellipse to reduce losses

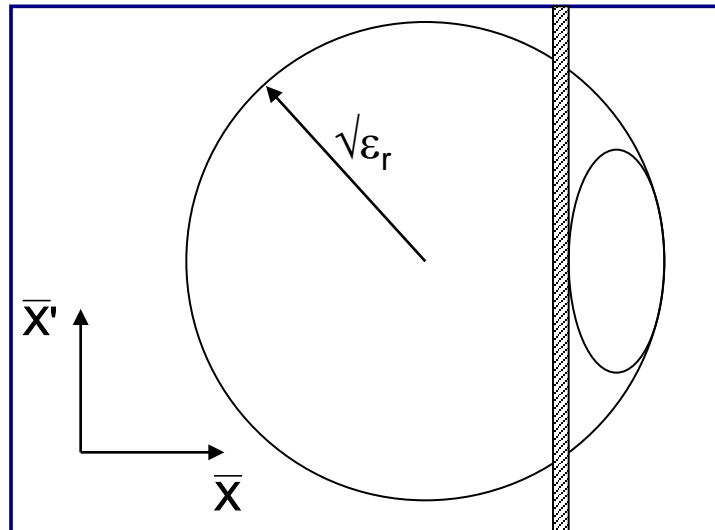

- Optimum for  $\frac{\beta_i}{\beta_r} \approx \frac{\alpha_i}{\alpha_r} \approx \left(\frac{\epsilon_i}{\epsilon_r}\right)^{1/3}$ ,  $\frac{\alpha_r}{\beta_r} = \frac{\alpha_i}{\beta_i} = -\frac{x'_r}{x_r}$ ,  $n = 0.5 - 0.7 \frac{\epsilon_r}{\epsilon_i}$

# Charge exchange H- injection

- Multiturn injection is essential to accumulate high intensity
- Disadvantages inherent in using an injection septum
  - Width of several mm reduces aperture
  - Beam losses from circulating beam hitting septum
  - Limits number of injected turns to 10-20
- Charge-exchange injection provides elegant alternative
  - Possible to “beat” Liouville’s theorem, which says that emittance is conserved....
  - Convert  $H^-$  to  $p^+$  using a thin stripping foil, allowing injection into the same phase space area

# Charge exchange H- injection

Start of injection process

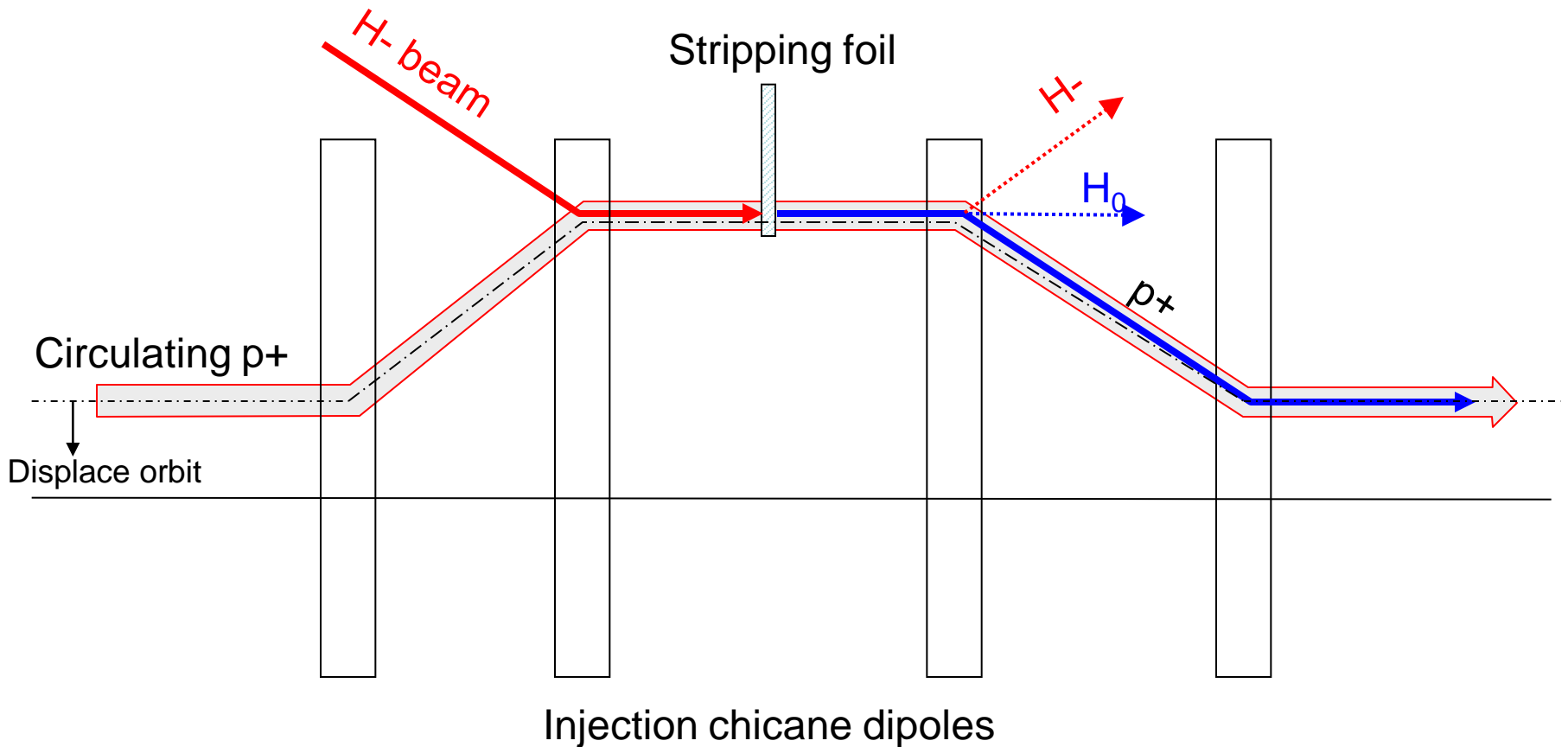

# Charge exchange H- injection

End of injection process

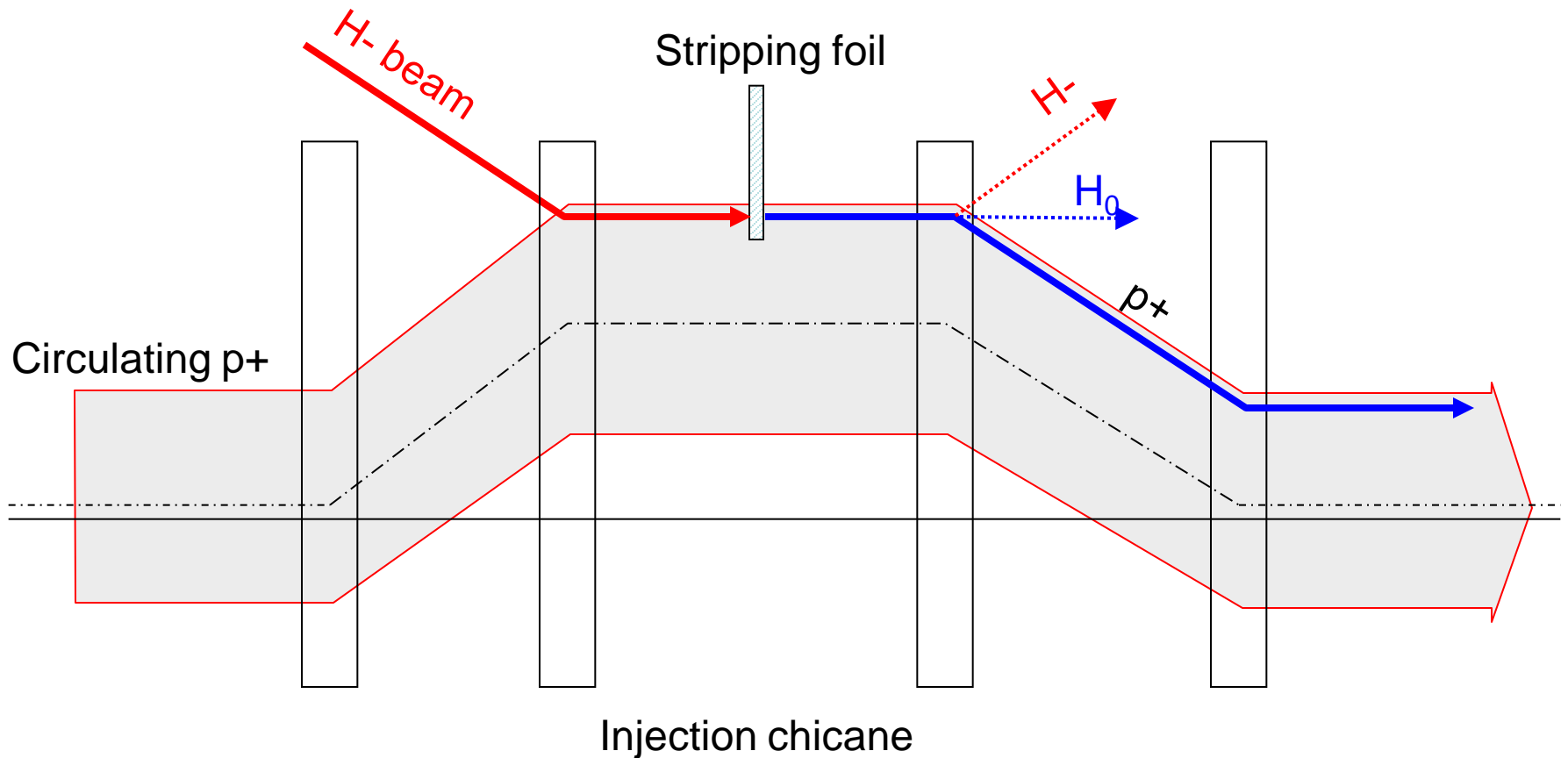

# Charge exchange H- injection

- Paint uniform transverse phase space density by modifying closed orbit bump and steering injected beam
- Foil thickness calculated to double-strip most ions (>99%)
  - 50 MeV - 50  $\mu\text{g.cm}^{-2}$
  - 800 MeV - 200  $\mu\text{g.cm}^{-2}$  ( $\sim 1\mu\text{m}$  of C!)
- Carbon foils generally used – very fragile
- Injection chicane reduced or switched off after injection, to avoid excessive foil heating and beam blow up

# H- injection - painting

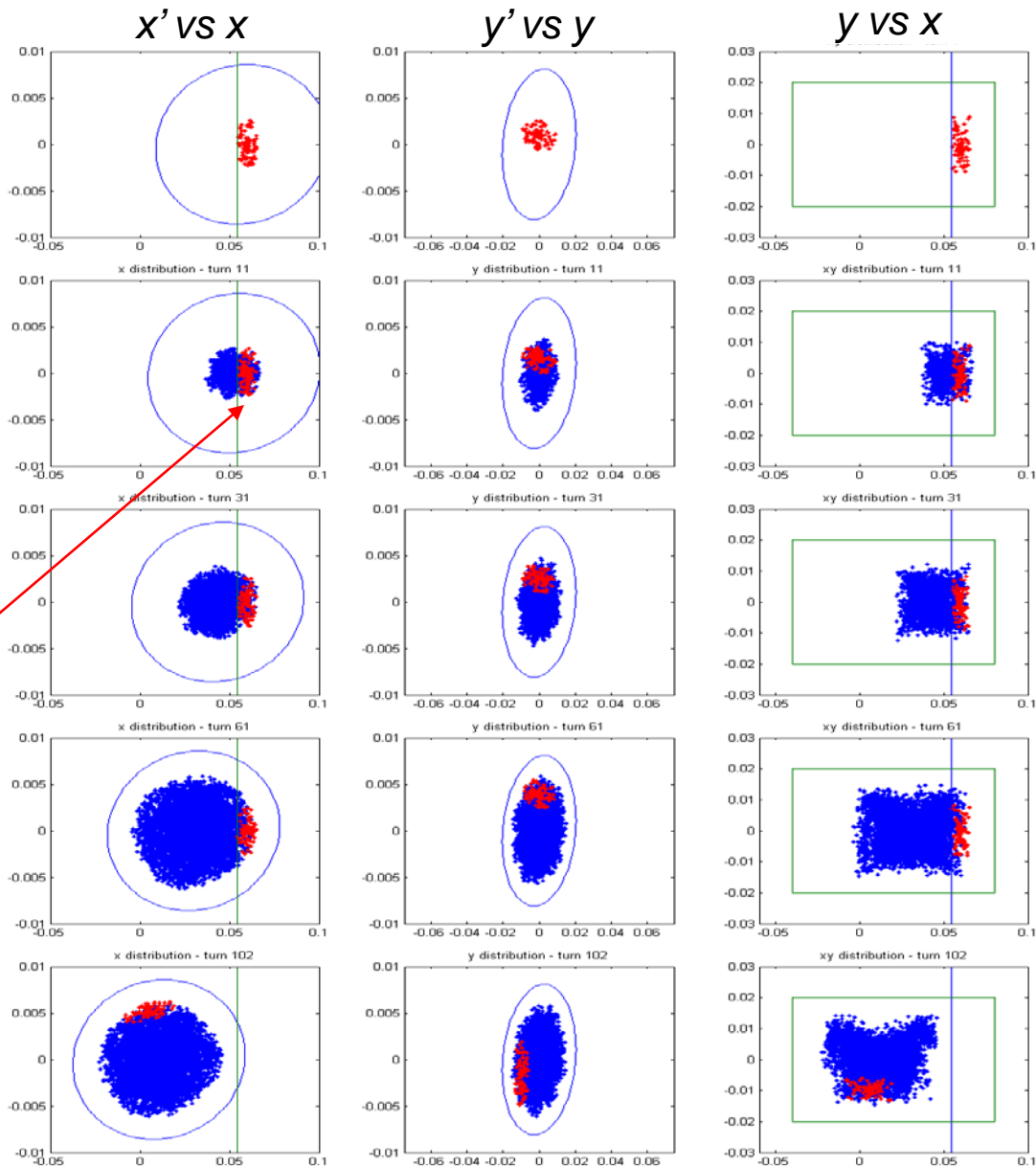

Time

Note injection into same phase space area as circulating beam

~100 turns

# Lepton injection

- Single-turn injection can be used as for hadrons; however, lepton motion is strongly damped (different with respect to proton or ion injection).
  - Synchrotron radiation
- Can use transverse or longitudinal damping:
  - Transverse - Betatron accumulation
  - Longitudinal - Synchrotron accumulation

# Betatron lepton injection

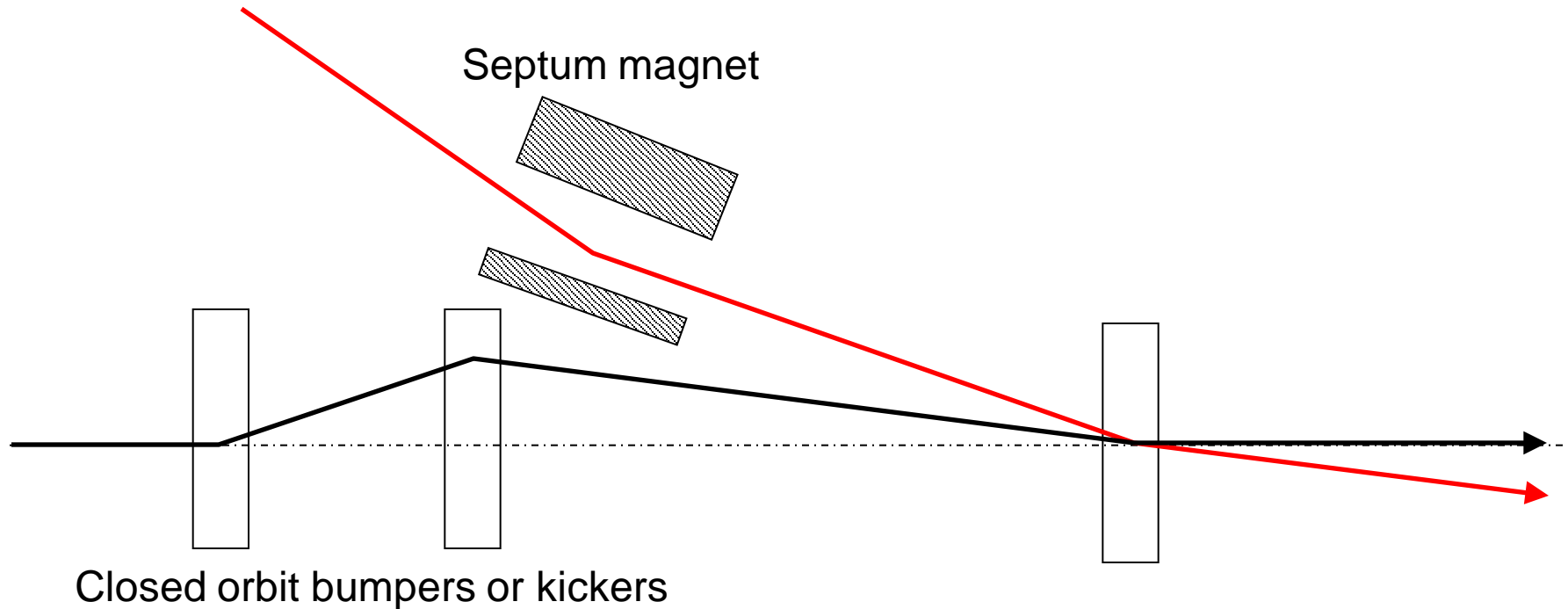

- Beam is injected with an angle with respect to the closed orbit
- Injected beam performs damped betatron oscillations about the closed orbit



# Betatron lepton injection

Injected bunch performs damped betatron oscillations

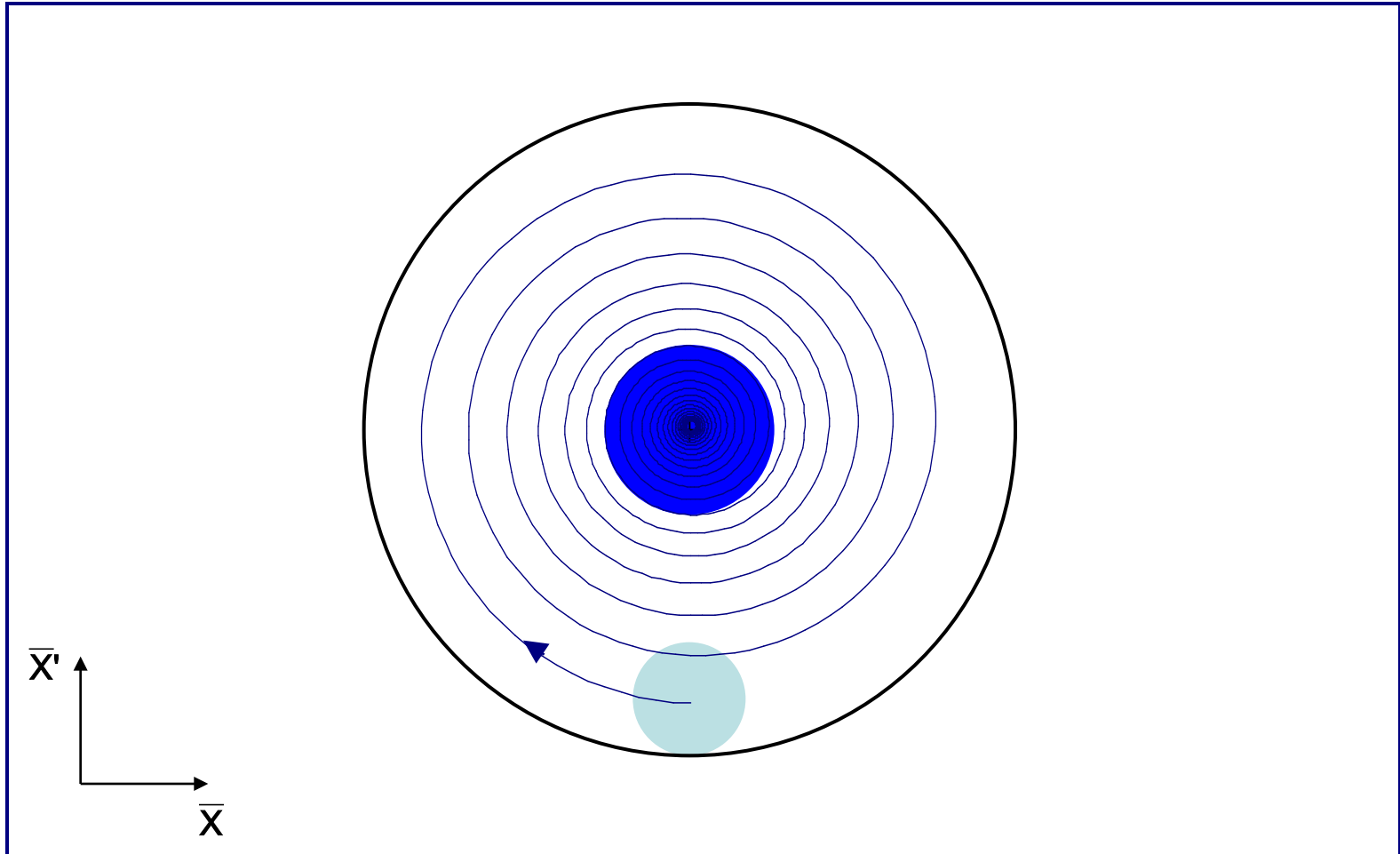

In LEP at 20 GeV, the damping time was about 6'000 turns (0.6 seconds)

# Synchrotron lepton injection

Inject an off-momentum beam

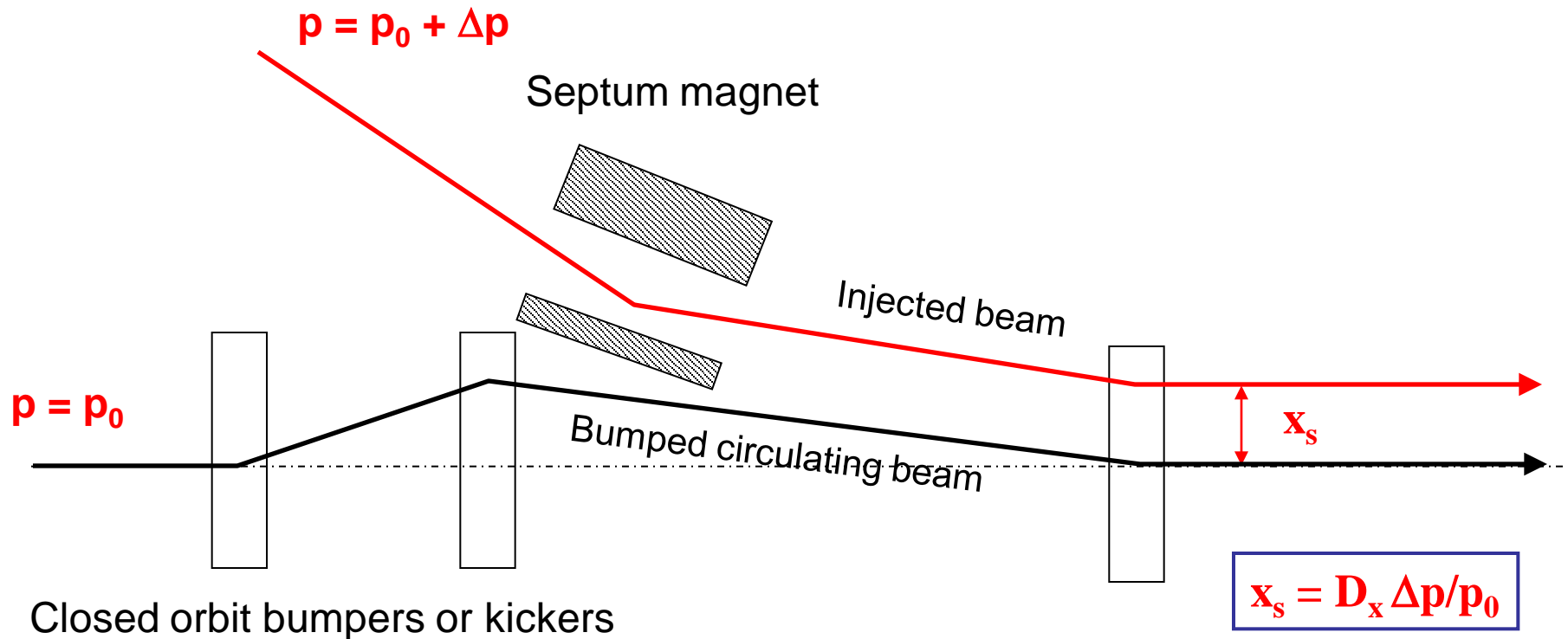

- Beam injected parallel to circulating beam, onto dispersion orbit of a particle having the same momentum offset  $\Delta p/p$ .
- Injected beam makes damped *synchrotron oscillations* at  $Q_s$  but does not perform betatron oscillations.

# Synchrotron lepton injection

Double batch injection possible....

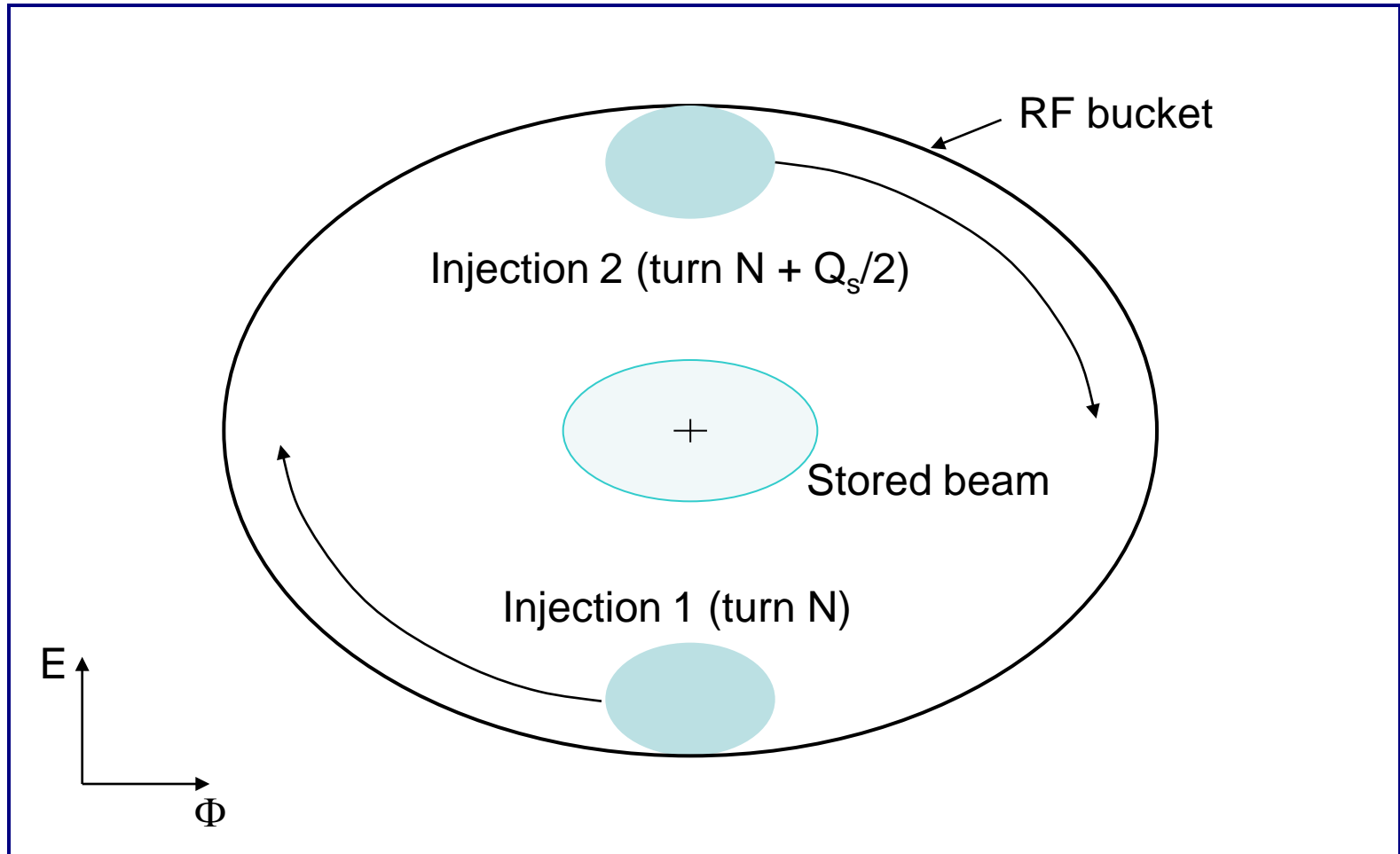

Longitudinal damping time in LEP was  $\sim 3'000$  turns (2 x faster than transverse)

# Synchrotron lepton injection in LEP

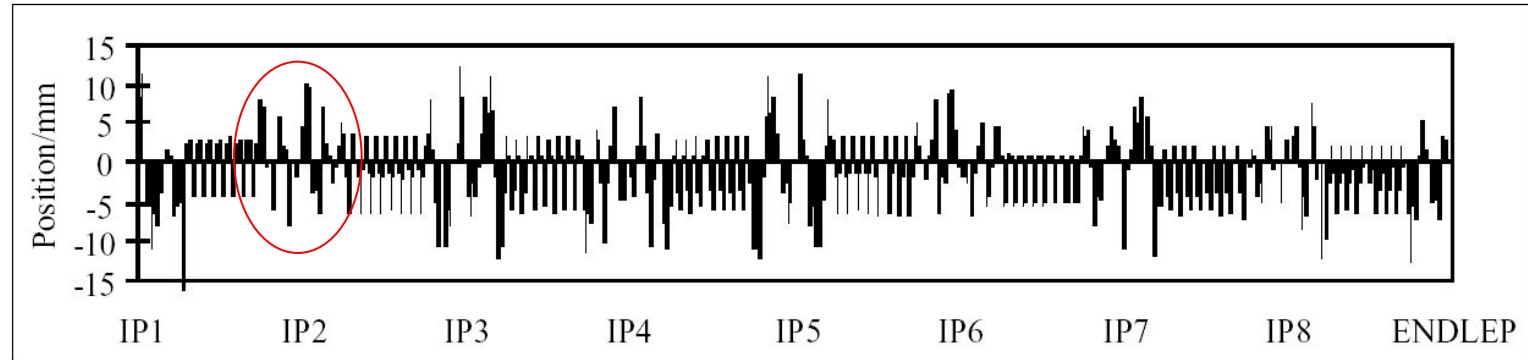

Optimized Horizontal First Turn Trajectory for Betatron Injection of Positrons into LEP.

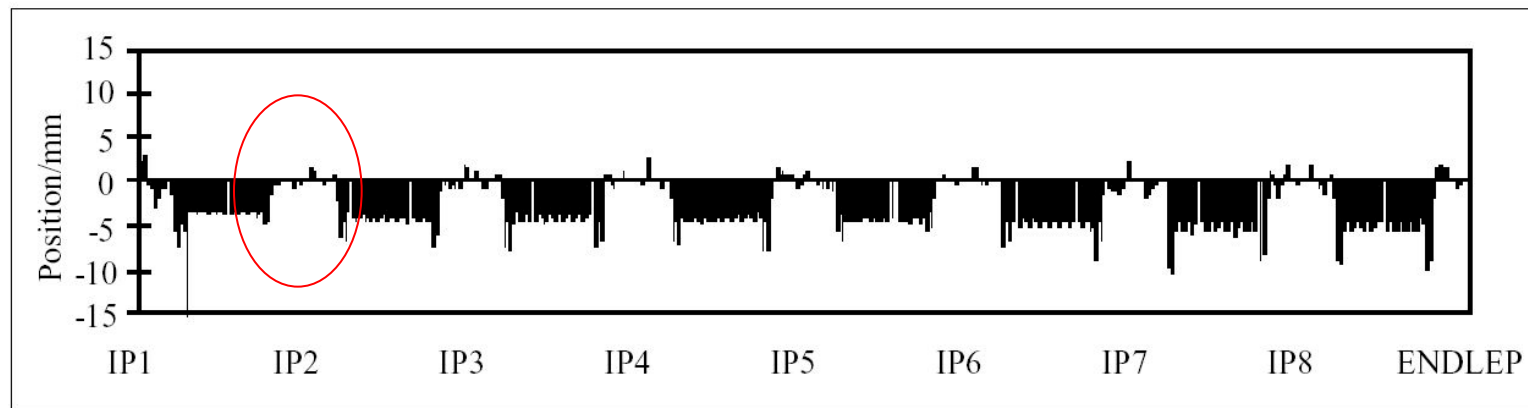

Optimized Horizontal First Turn Trajectory for Synchrotron Injection of Positrons with  $\Delta P/P$  at -0.6%

Synchrotron Injection in LEP gave improved background for LEP experiments due to small orbit offsets in zero dispersion straight sections

# Injection - summary

- Several different techniques
  - Single-turn injection for hadrons
    - Boxcar stacking: transfer between machines in accelerator chain
    - Angle / position errors  $\Rightarrow$  injection oscillations
    - Optics errors  $\Rightarrow$  betatron mismatch oscillations
    - Oscillations  $\Rightarrow$  filamentation  $\Rightarrow$  emittance increase
  - Multi-turn injection for hadrons
    - Phase space painting to increase intensity
    - H- injection allows injection into same phase space area
  - Lepton injection: take advantage of damping
    - Less concerned about injection precision and matching

# Extraction

- Different extraction techniques exist, depending on requirements
  - Fast extraction:  $\leq 1$  turn
  - Non-resonant multi-turn extraction: few turns
  - Resonant multi-turn extraction: many thousands of turns
  - Resonant low-loss multi-turn extraction: few turns
- Usually higher energy than injection  $\Rightarrow$  stronger elements ( $\int B \cdot dl$ )
  - At high energies many kicker and septum modules may be required
  - To reduce kicker and septum strength, beam can be moved near to septum by closed orbit bump

# Fast single turn extraction

Whole beam kicked into septum gap and extracted.

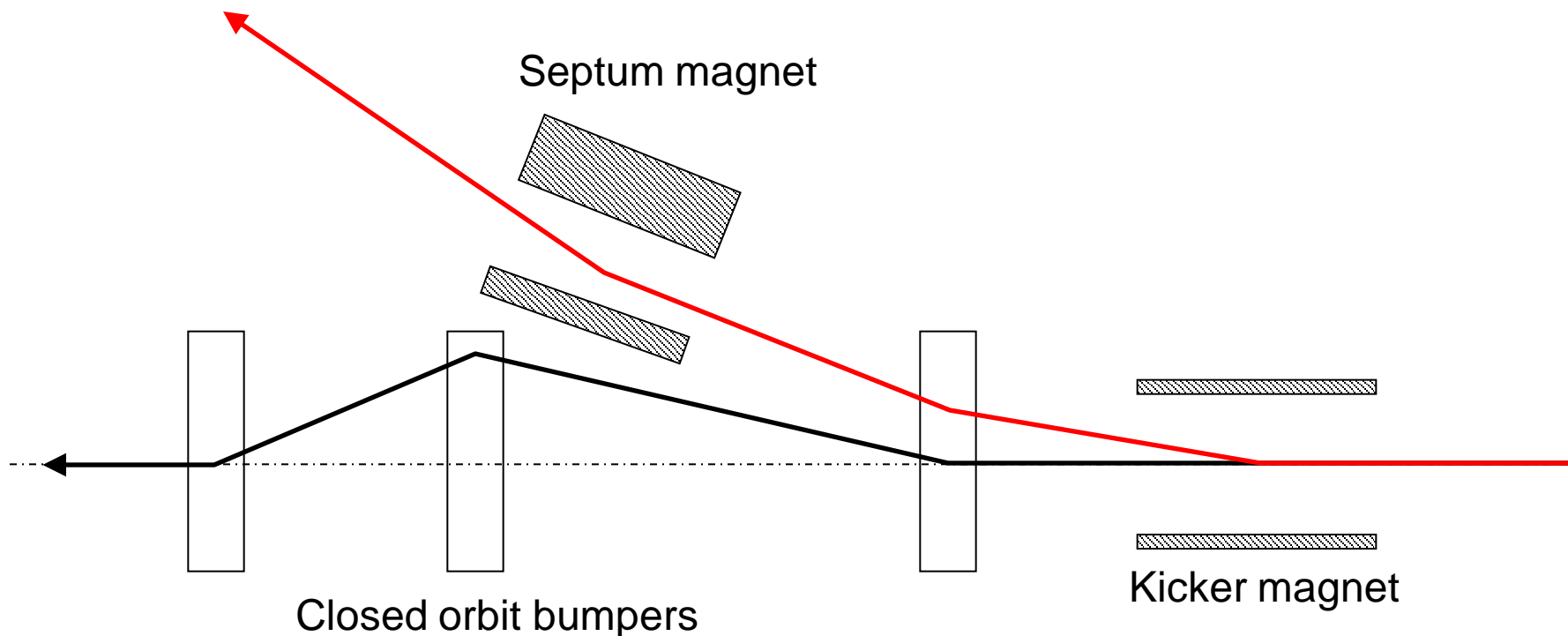

- Kicker deflects the entire beam into the septum in a single turn
- Septum deflects the beam entire into the transfer line
- Most efficient (lowest deflection angles required) for  $\pi/2$  phase advance between kicker and septum

# Fast single turn extraction

- For transfer of beams between accelerators in an injector chain.
- For secondary particle production (e.g. neutrinos)
- Septum deflection may be in the other plane to the kicker deflection.
- Losses from transverse scraping or from particles in extraction gap

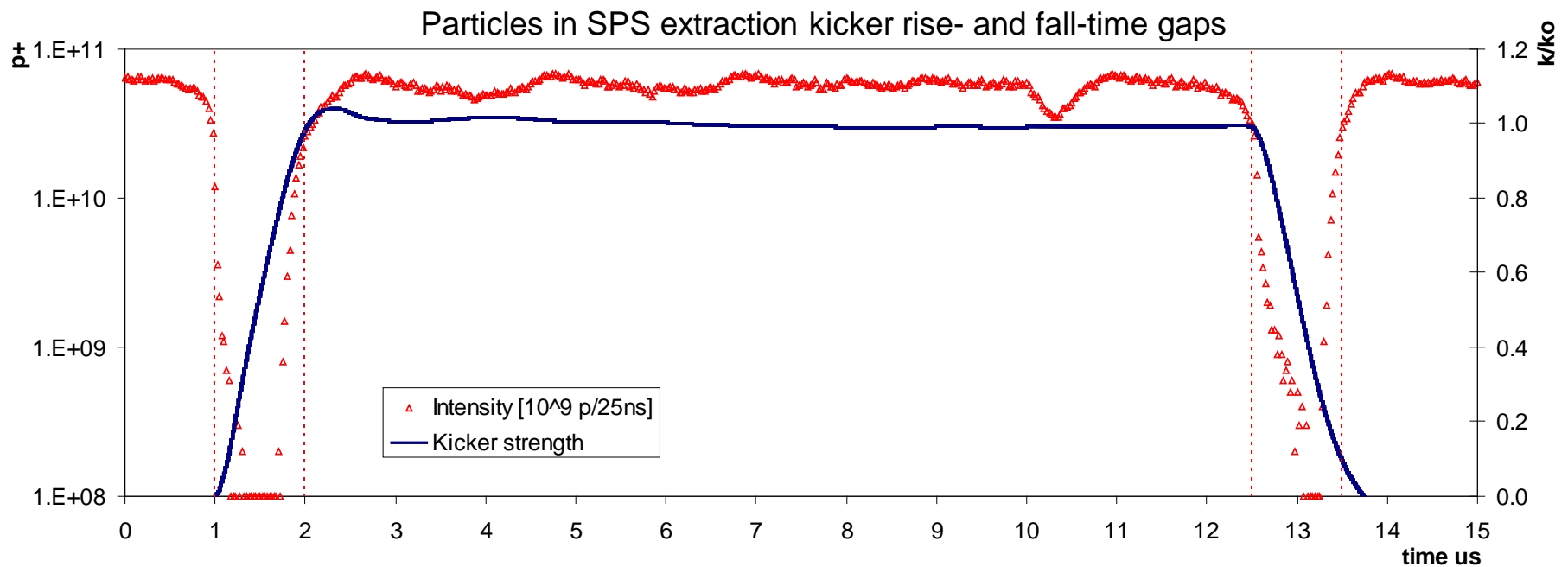



# Multi-turn extraction

- Some filling schemes require a beam to be injected in several turns to a larger machine...
- And very commonly Fixed Target physics experiments and medical accelerators often need a quasi-continuous flux of particles...
- Multi-turn extraction...
  - Non-Resonant multi-turn ejection (few turns) for filling e.g. PS to SPS at CERN for high intensity proton beams ( $>2.5 \cdot 10^{13}$  protons)
  - Resonant extraction (ms to hours) for experiments

# Non-resonant multi-turn extraction

Beam bumped to septum; part of beam 'shaved' off each turn.

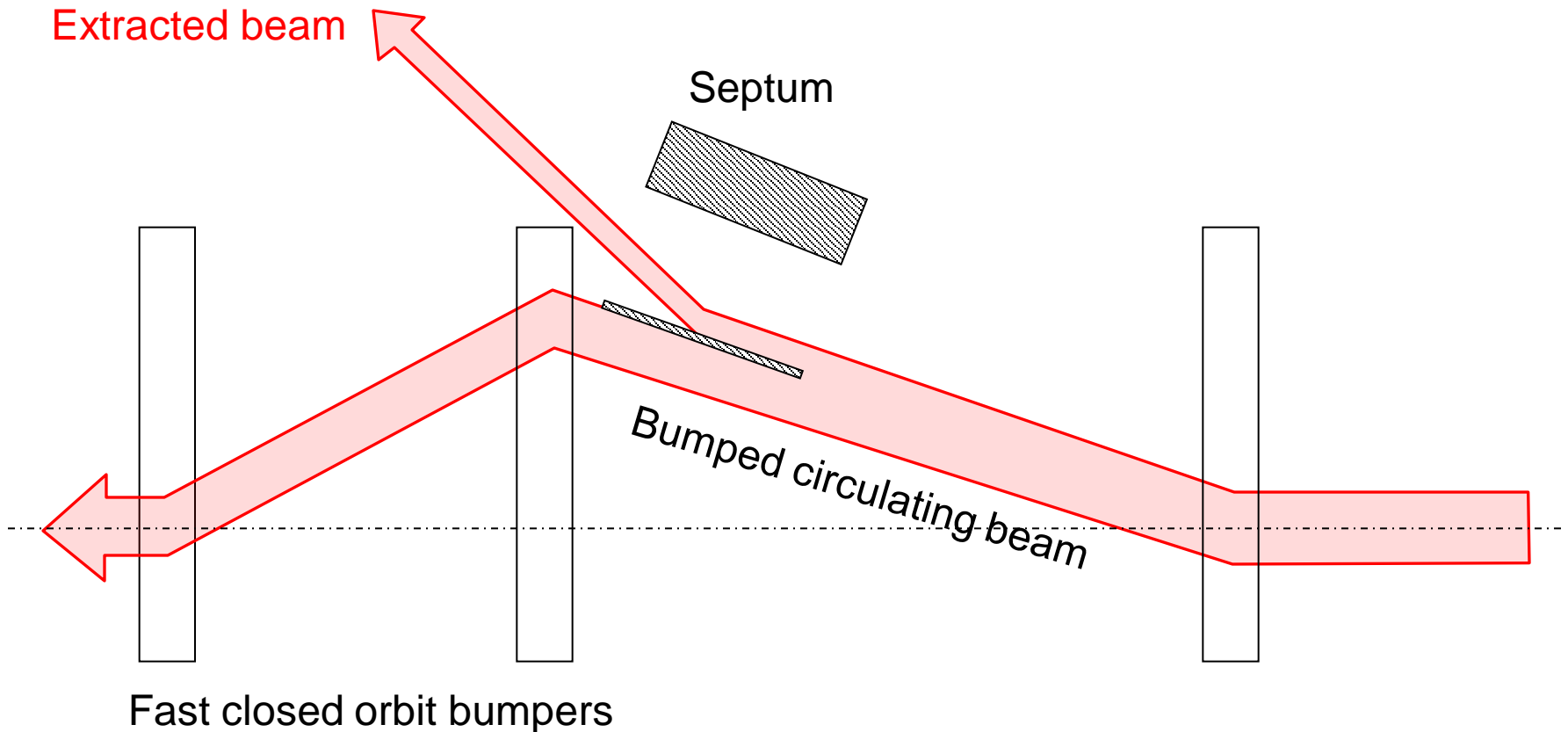

- Fast bumper deflects the whole beam onto the septum
- Beam extracted in a few turns, with the machine tune rotating the beam
- Inherently a high-loss process – thin septum essential

# Non-resonant multi-turn extraction

- Example system: CERN PS to SPS Fixed-Target 'continuous transfer'.
  - Accelerate beam in PS to 14 GeV/c
  - Empty PS machine (2.1  $\mu\text{s}$  long) in 5 turns into SPS
  - Do it again
  - Fill SPS machine (23  $\mu\text{s}$  long)
  - Quasi-continuous beam in SPS (2 x 1  $\mu\text{s}$  gaps)
  - Total intensity per PS extraction  $\approx 3 \times 10^{13}$  p+
  - Total intensity in SPS  $\approx 5 \times 10^{13}$  p+

# Non-resonant multi-turn extraction

CERN PS to SPS: 5-turn continuous transfer

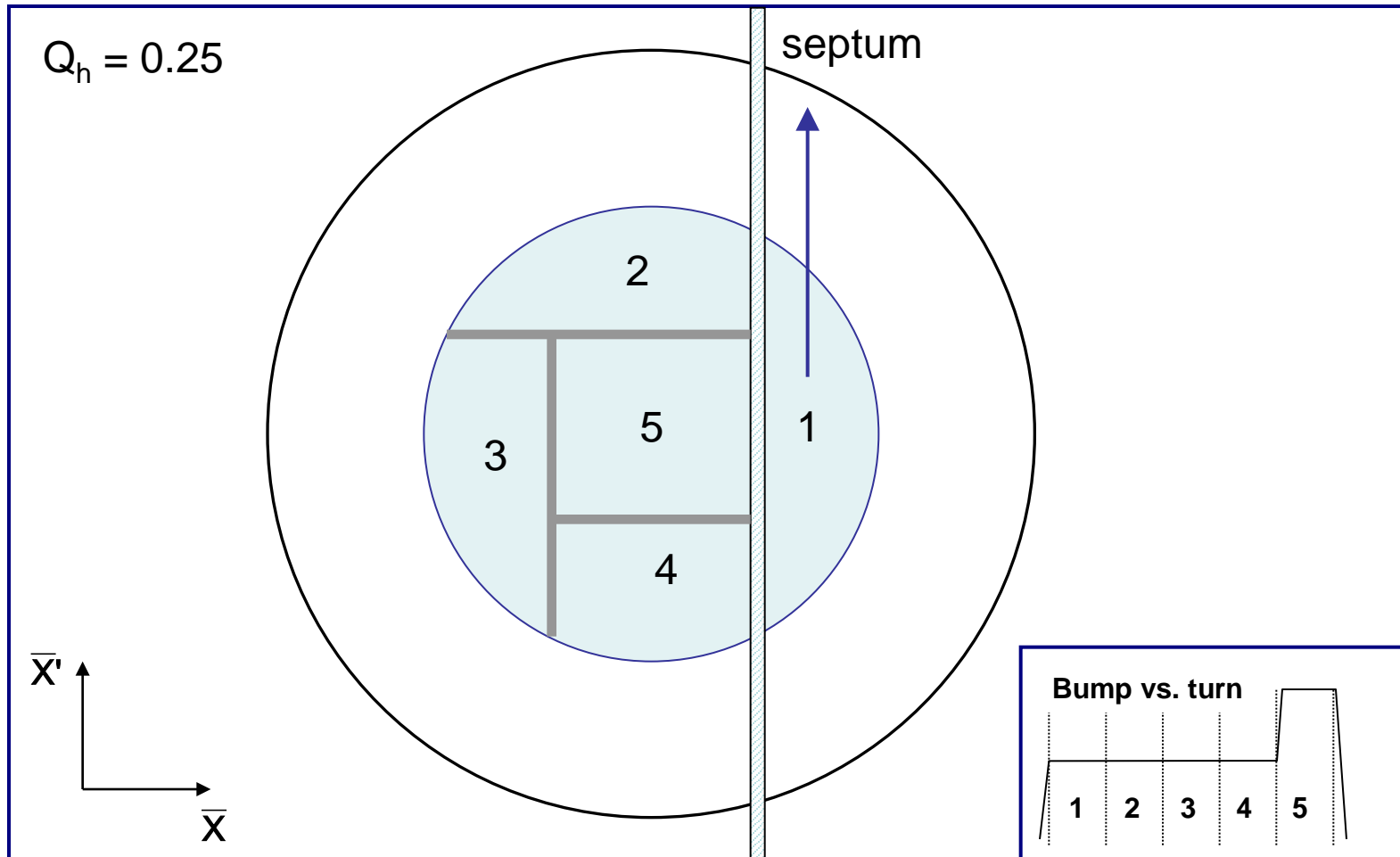

# Non-resonant multi-turn extraction

CERN PS to SPS: 5-turn continuous transfer – 5<sup>th</sup> turn

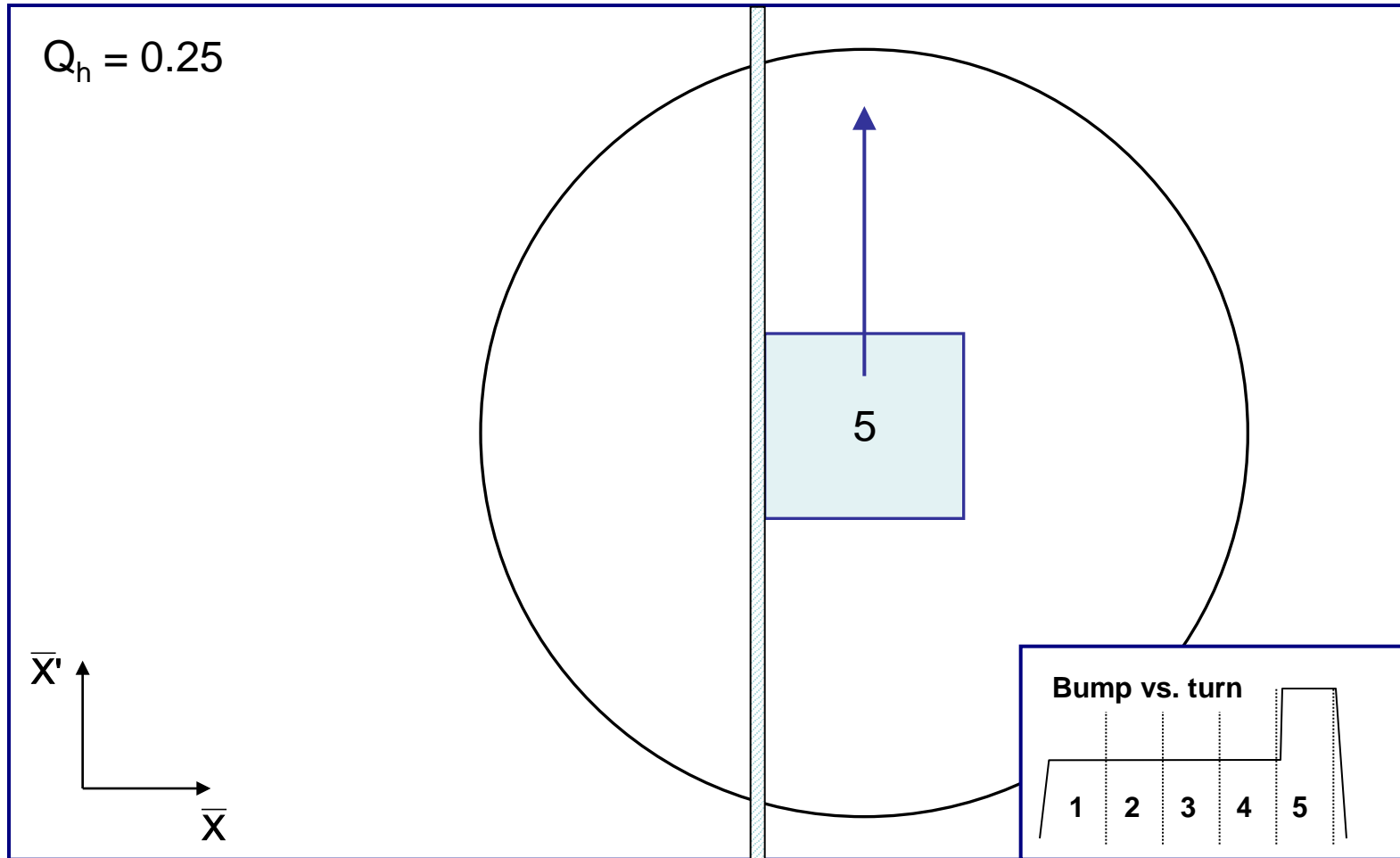

# Non-resonant multi-turn extraction

- CERN PS to SPS: 5-turn continuous transfer
  - Losses impose thin (ES) septum... second septum needed
  - Still about 15 % of beam lost in PS-SPS CT
  - Difficult to get equal intensities per turn
  - Different trajectories for each turn
  - Different emittances for each turn

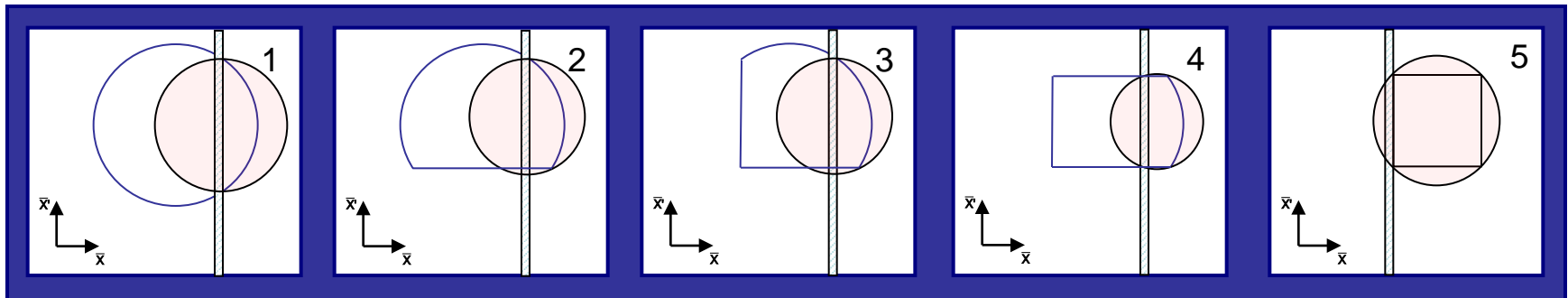
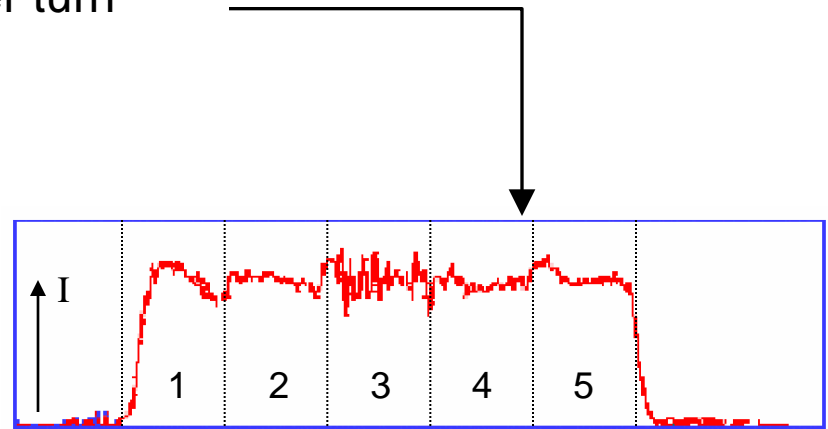

# Resonant multi-turn extraction

Non-linear fields excite resonances which drive the beam slowly across the septum.

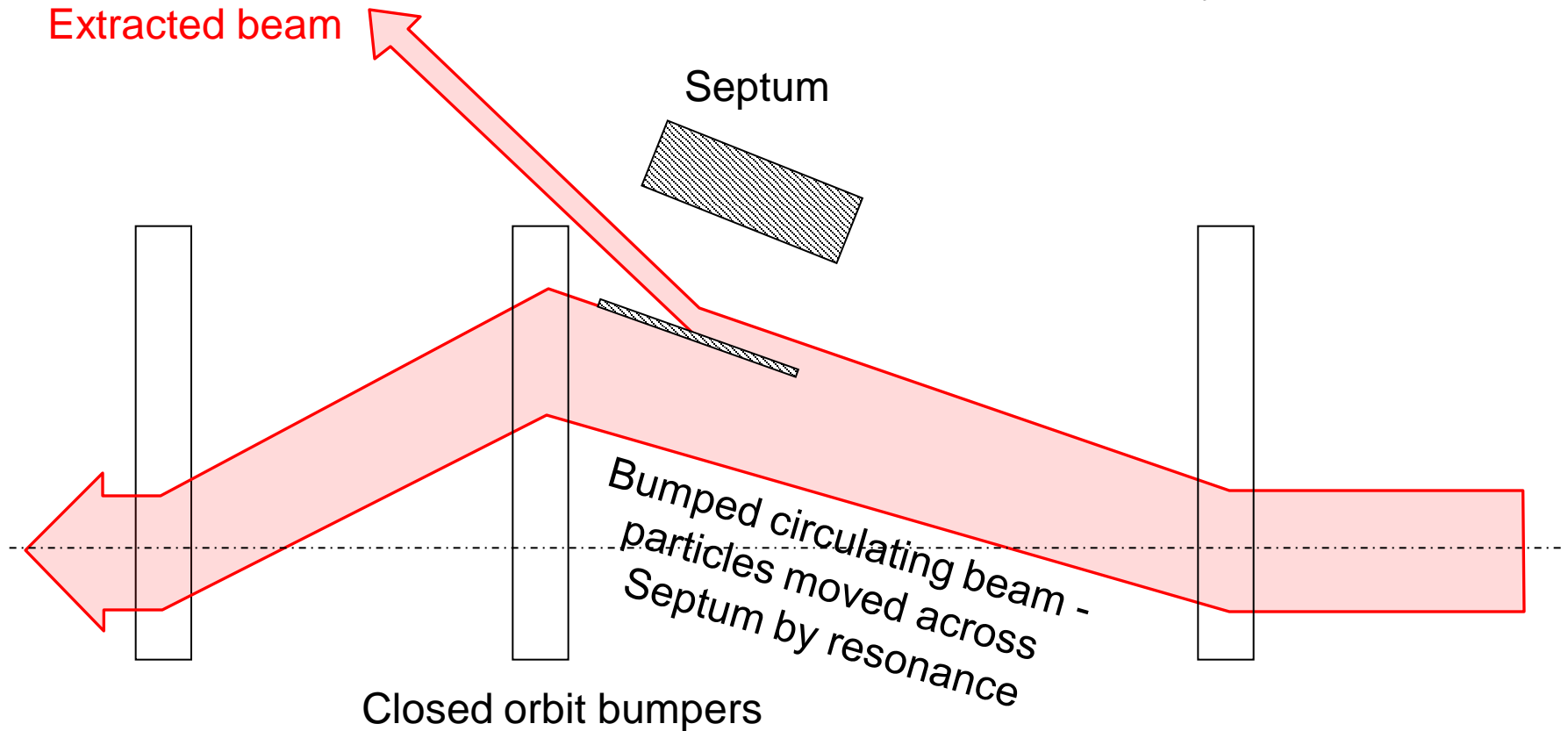

- Slow bumpers move the beam near the septum
- Tune adjusted close to  $n^{\text{th}}$  order betatron resonance
- Multipole magnets excited to define stable area in phase space, size depends on  $\Delta Q = Q - Q_r$

# Resonant multi-turn extraction

- 3<sup>rd</sup> order resonances – Lecture from O.B.
  - Sextupole fields distort the circular normalised phase space particle trajectories.
  - Stable area defined, delimited by unstable Fixed Points.

$$R_{fp}^{1/2} \propto \Delta Q \cdot \frac{1}{k_2}$$

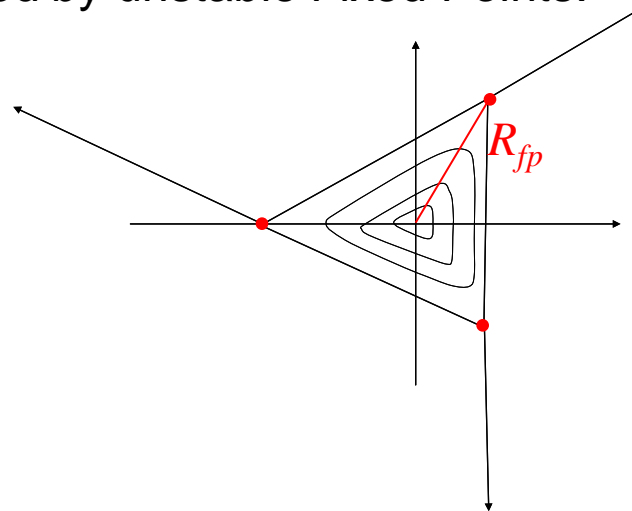

- Sextupoles families arranged to produce suitable phase space orientation of the stable triangle at thin electrostatic septum
- Stable area can be reduced by increasing the sextupole strength, or (easier) by approaching machine tune  $Q_h$  to resonant 1/3 integer tune
- Reducing  $\Delta Q$  with main machine quadrupoles can be augmented with a ‘servo’ quadrupole, which can modulate  $\Delta Q$  in a servo loop, acting on a measurement of the spill intensity



# Third-order resonant extraction

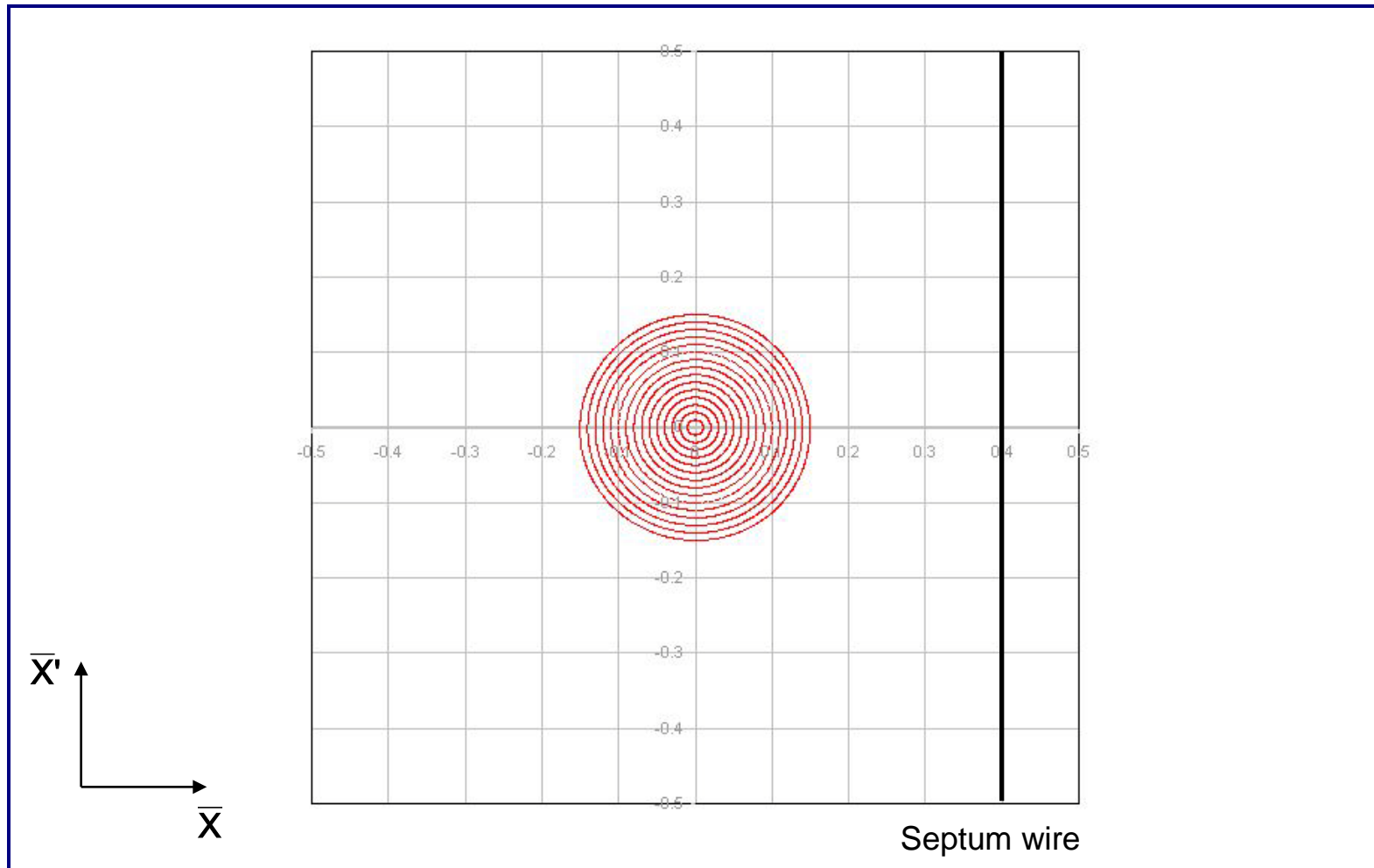

- Particles distributed on emittance contours
- $\Delta Q$  large – no phase space distortion

# Third-order resonant extraction

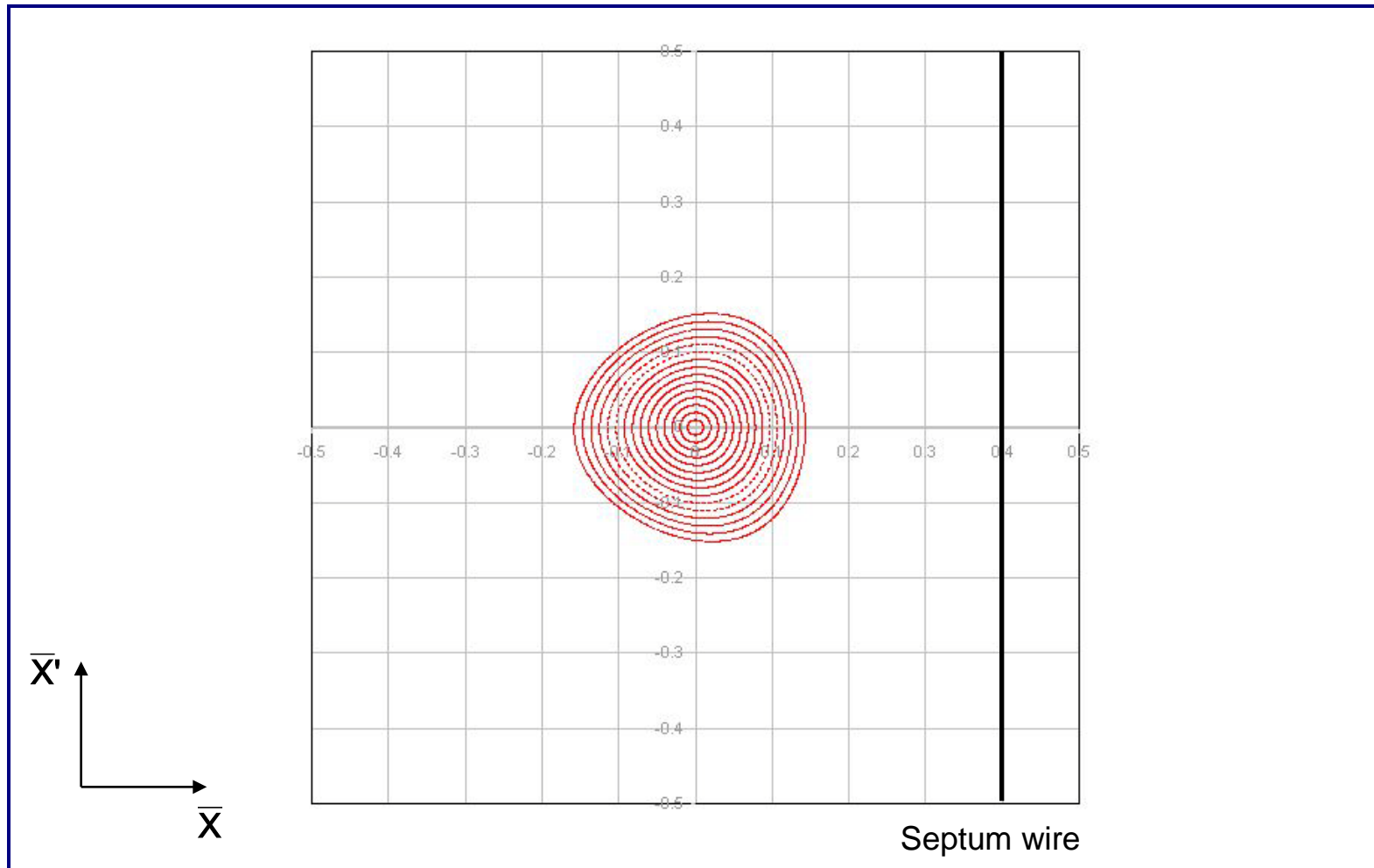

- Dedicated sextupole magnets produce a triangular stable area in phase space
- $\Delta Q$  decreasing – phase space distortion for largest amplitudes

# Third-order resonant extraction

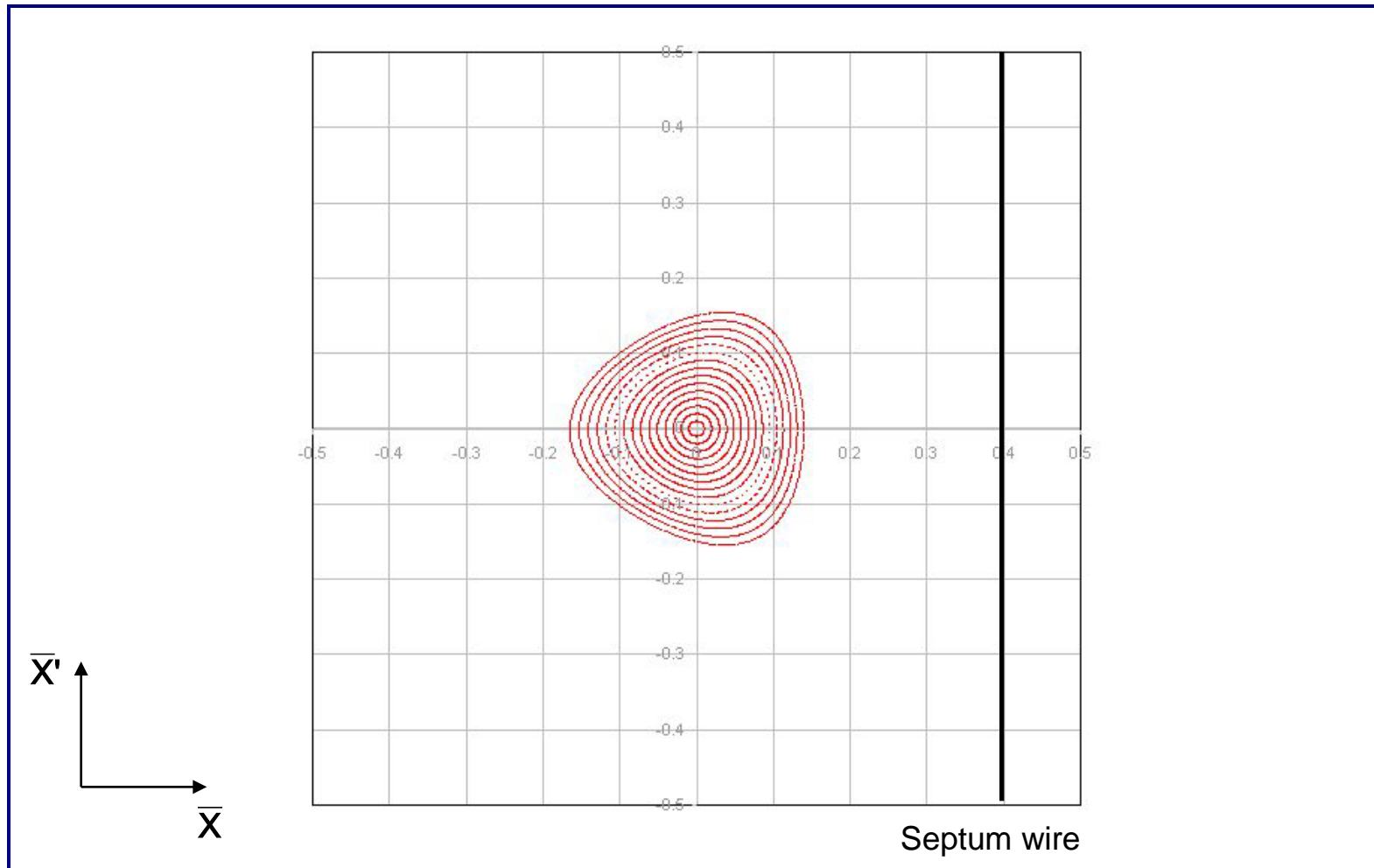

# Third-order resonant extraction

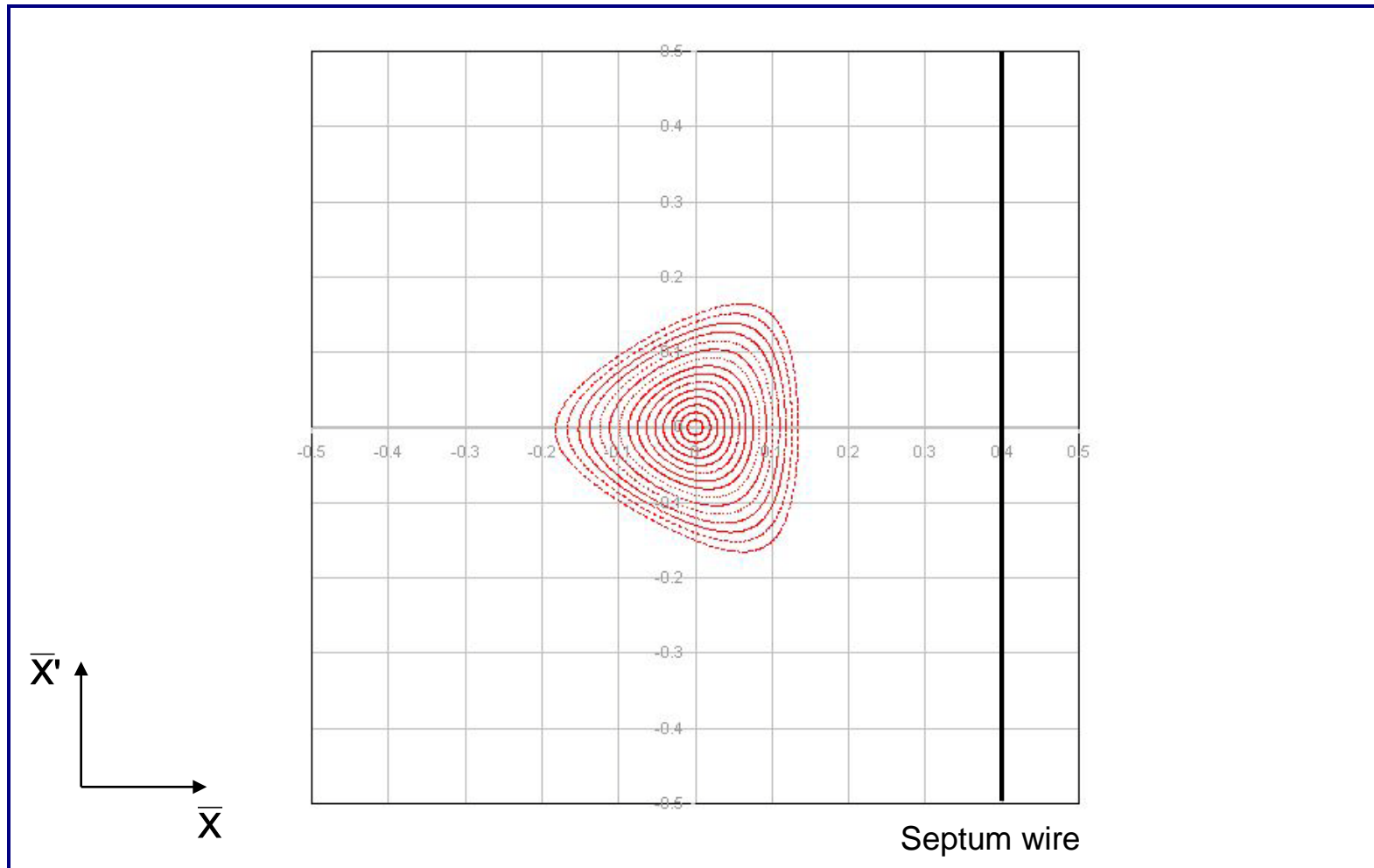

# Third-order resonant extraction

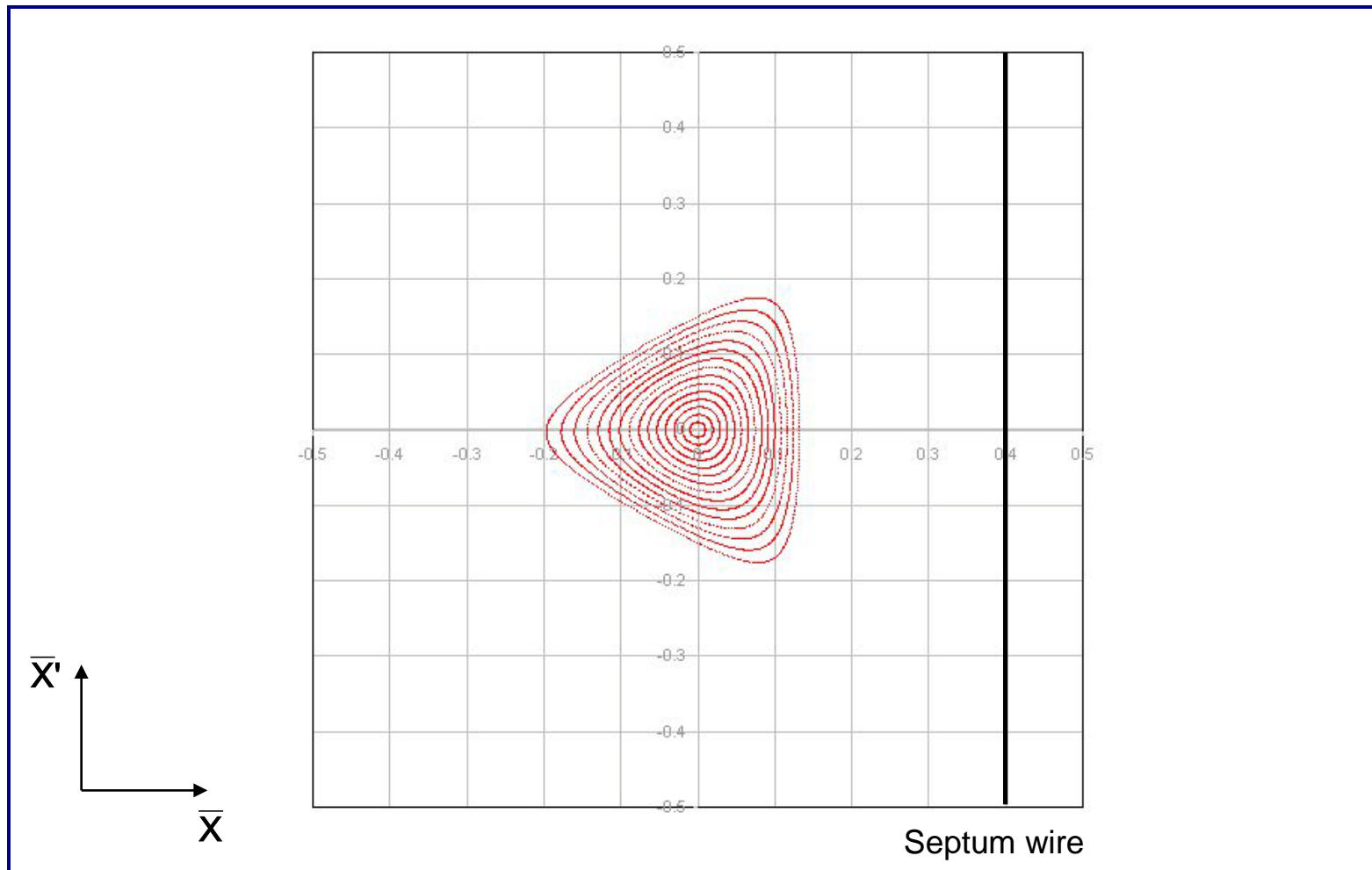

# Third-order resonant extraction

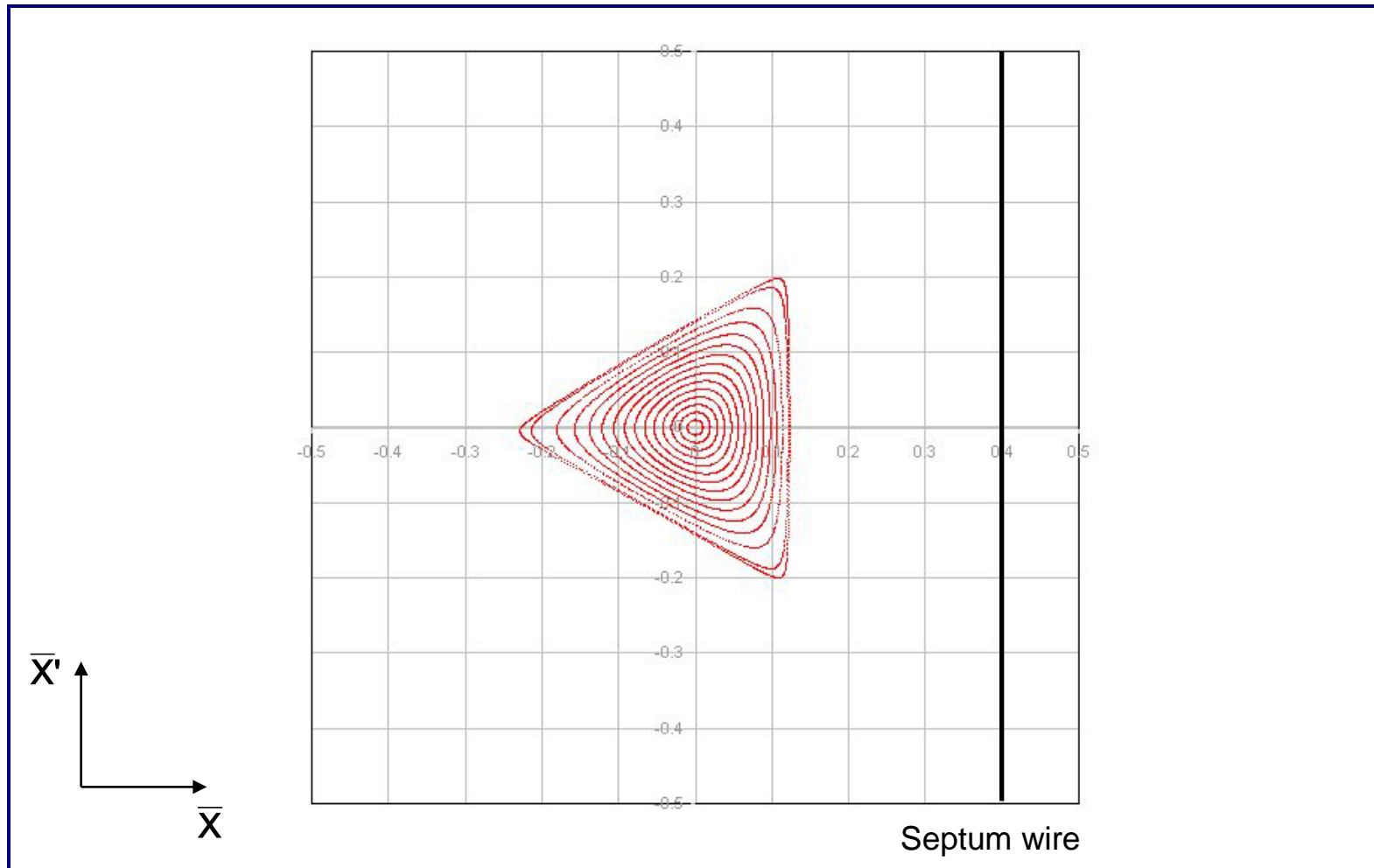

- $\Delta Q$  small enough that largest amplitude particles are close to the separatrices
- Fixed points locations discernable at extremities of phase space triangle

# Third-order resonant extraction

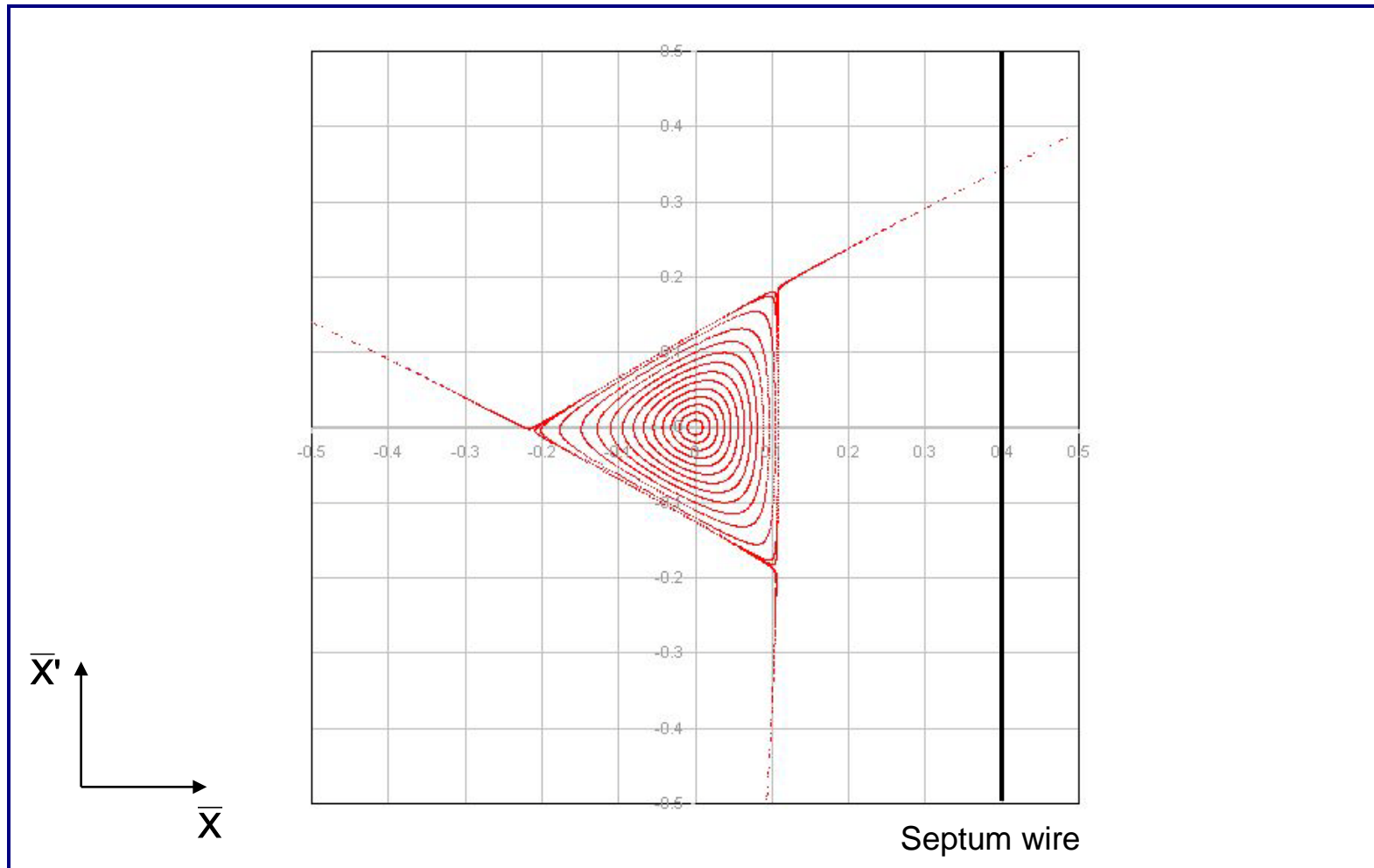

- $\Delta Q$  now small enough that largest amplitude particles are unstable
- Unstable particles follow separatrix branches as they increase in amplitude

# Third-order resonant extraction

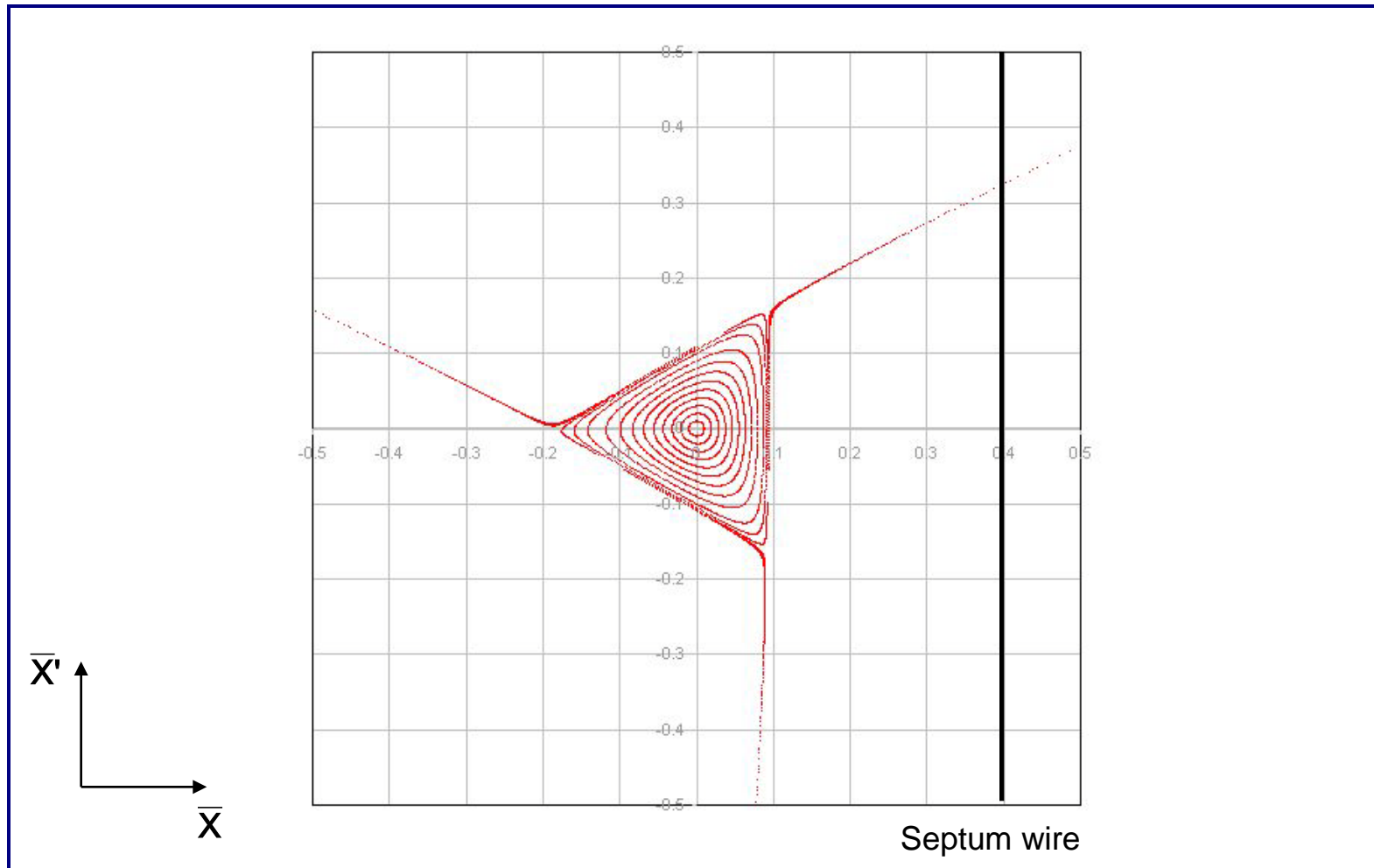

- Stable phase area shrinks as  $\Delta Q$  gets smaller



# Third-order resonant extraction

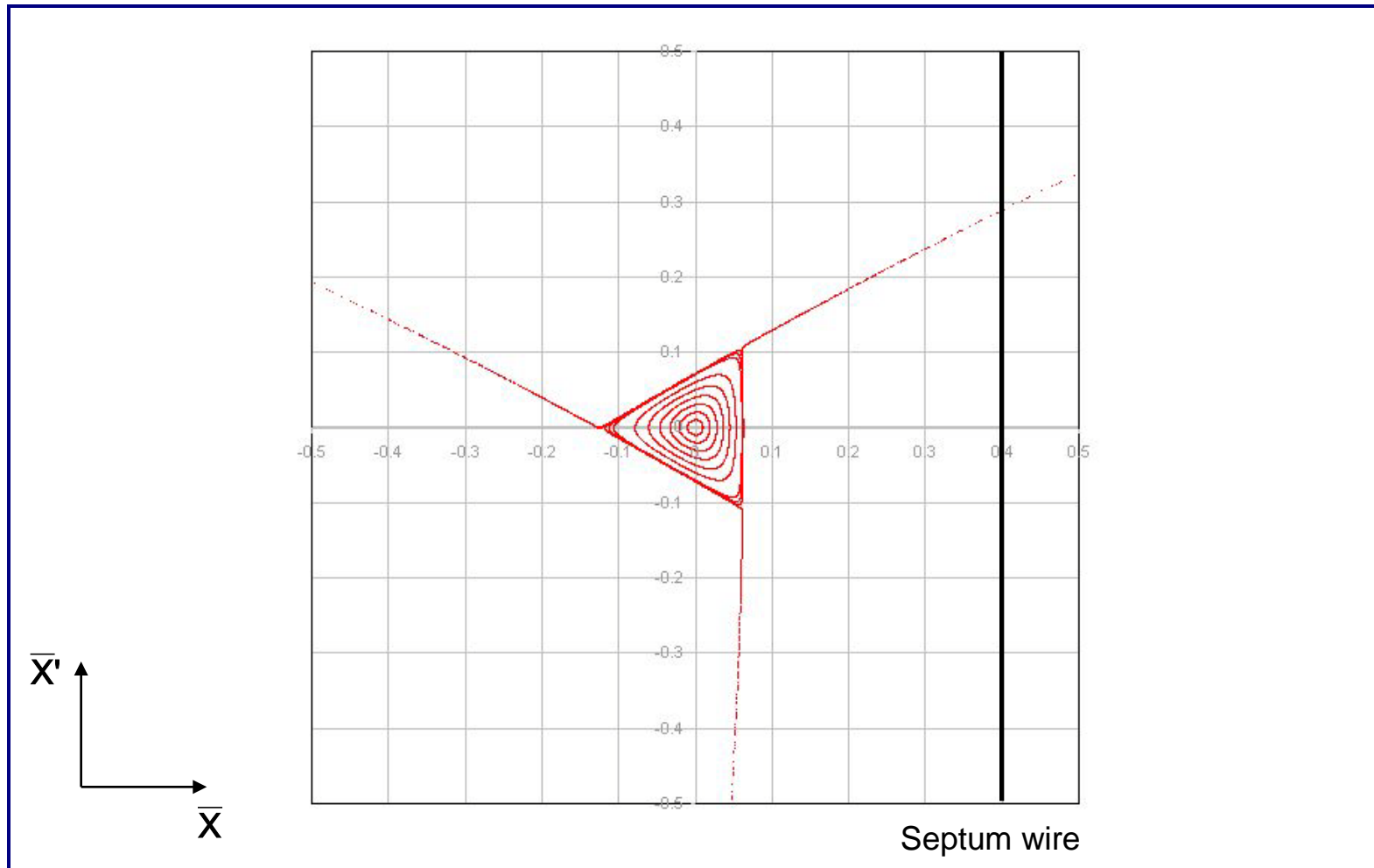

- Separatrix position in phase space shifts as the stable area shrinks

# Third-order resonant extraction

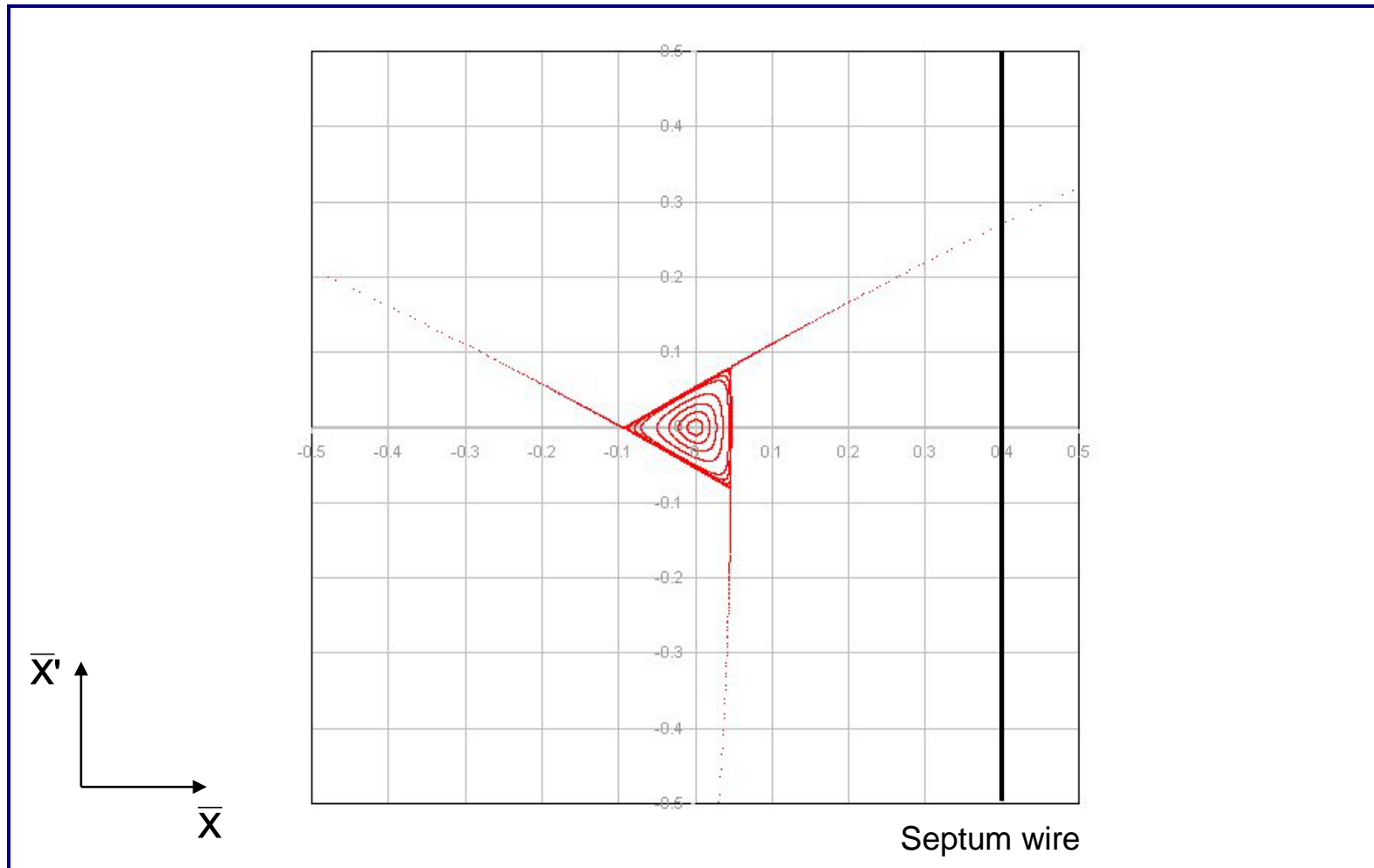

- As the stable area shrinks, the beam intensity drops since particles are being continuously extracted

# Third-order resonant extraction

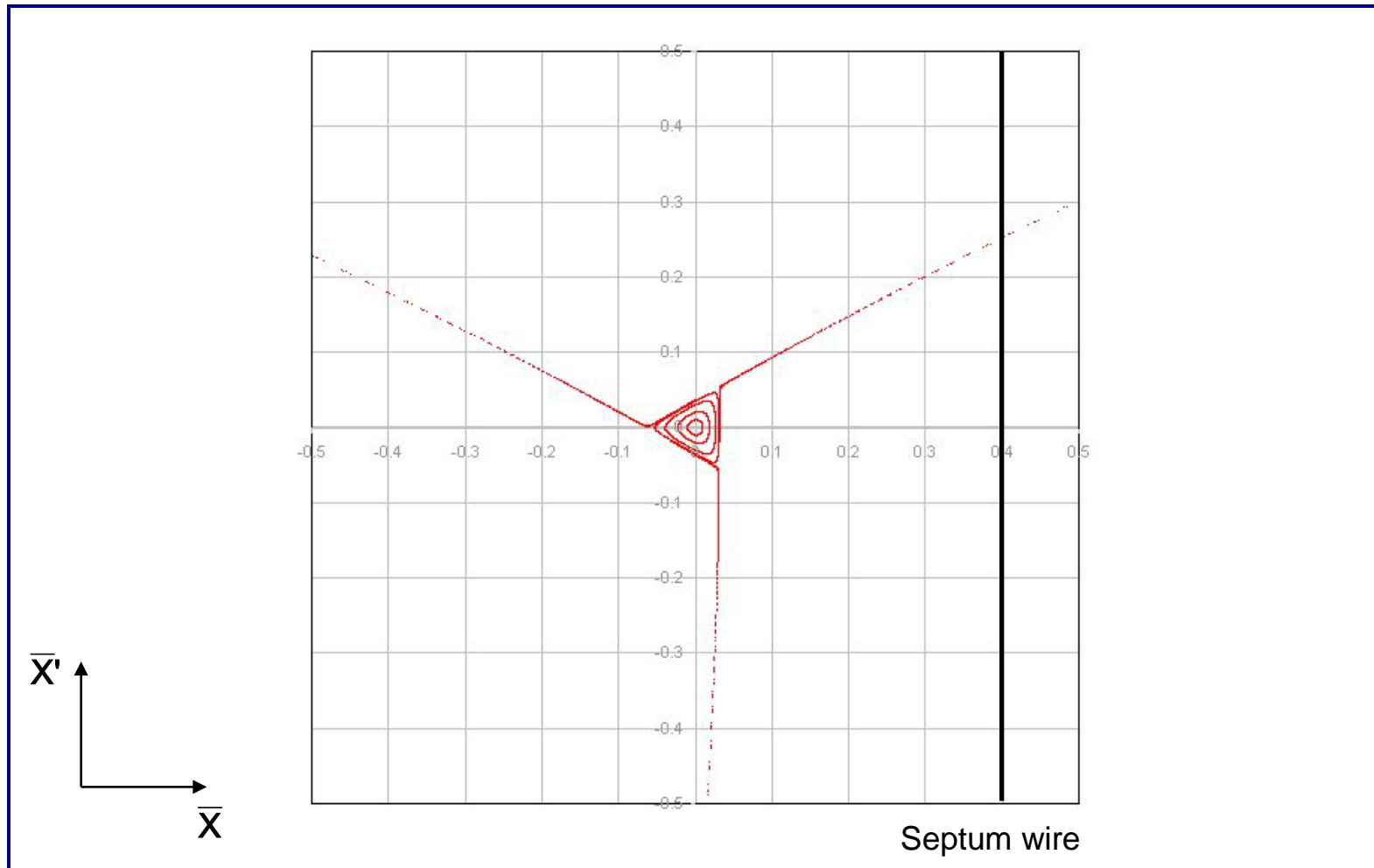

# Third-order resonant extraction

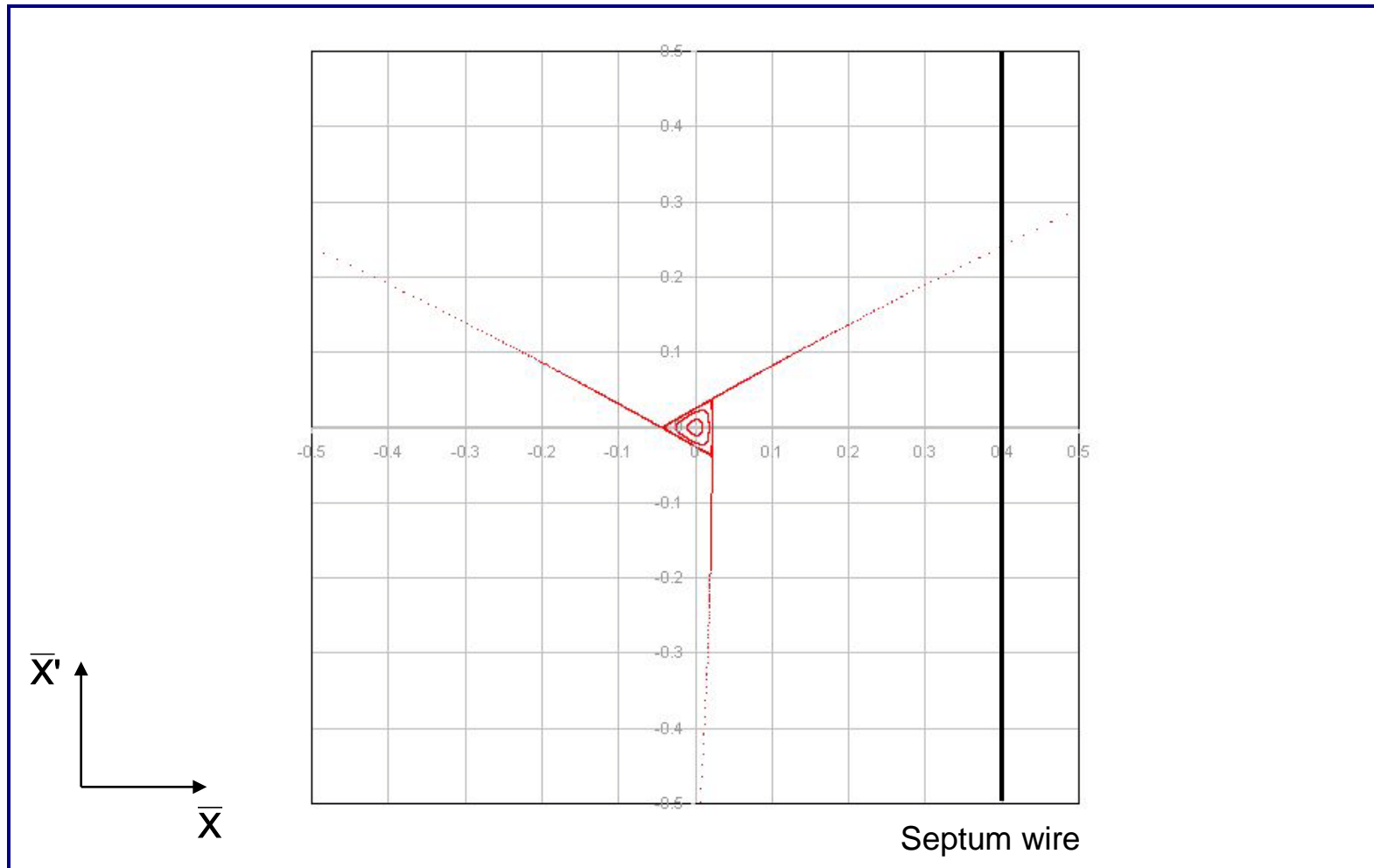

# Third-order resonant extraction

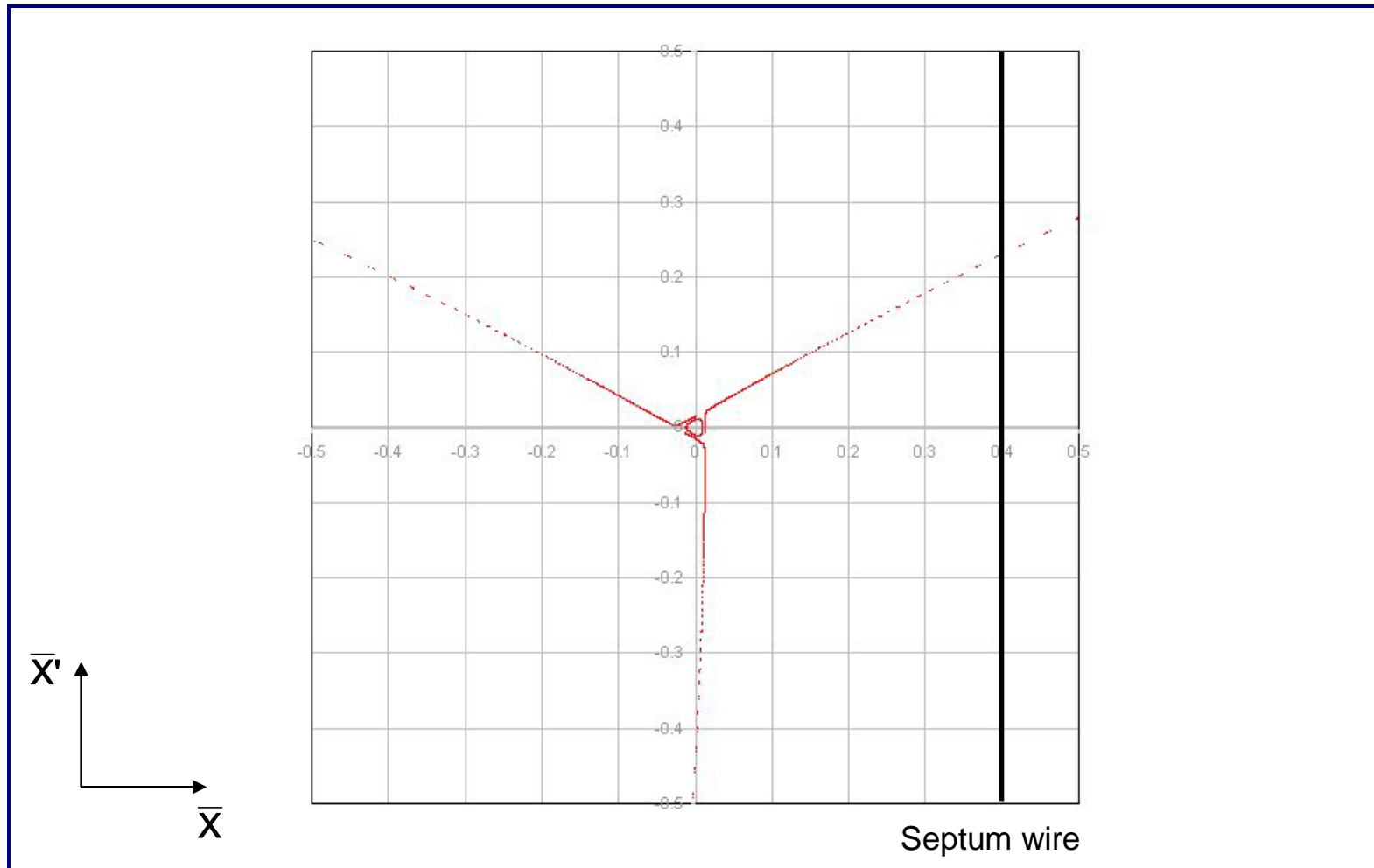

# Third-order resonant extraction

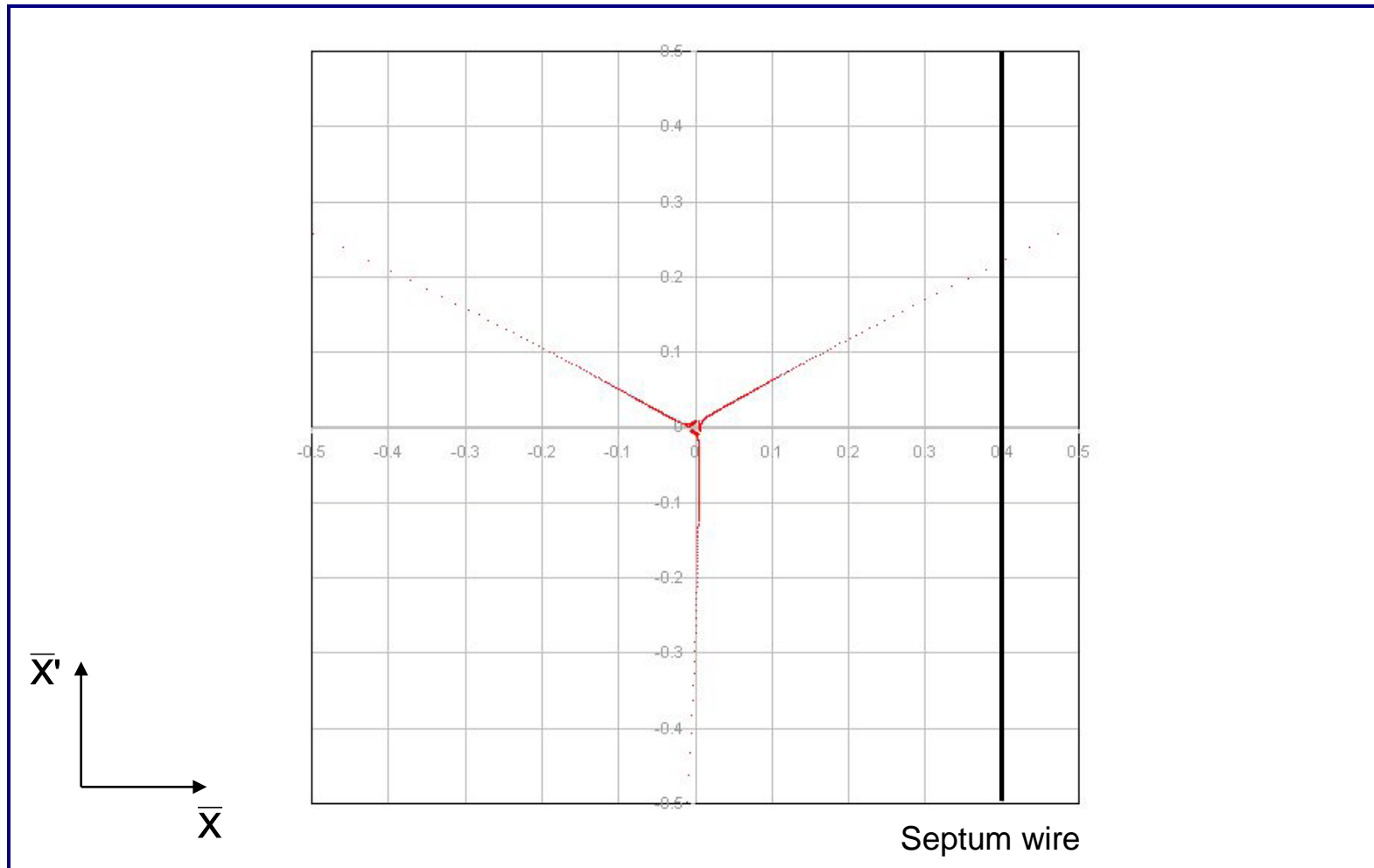

- As  $\Delta Q$  approaches zero, the particles with very small amplitude are extracted.

# Third-order resonant extraction

Example – SPS slow extraction at 450 GeV/c.

$\sim 3 \times 10^{13}$  p+ extracted in a 2-4 second long spill ( $\sim 200,000$  turns)

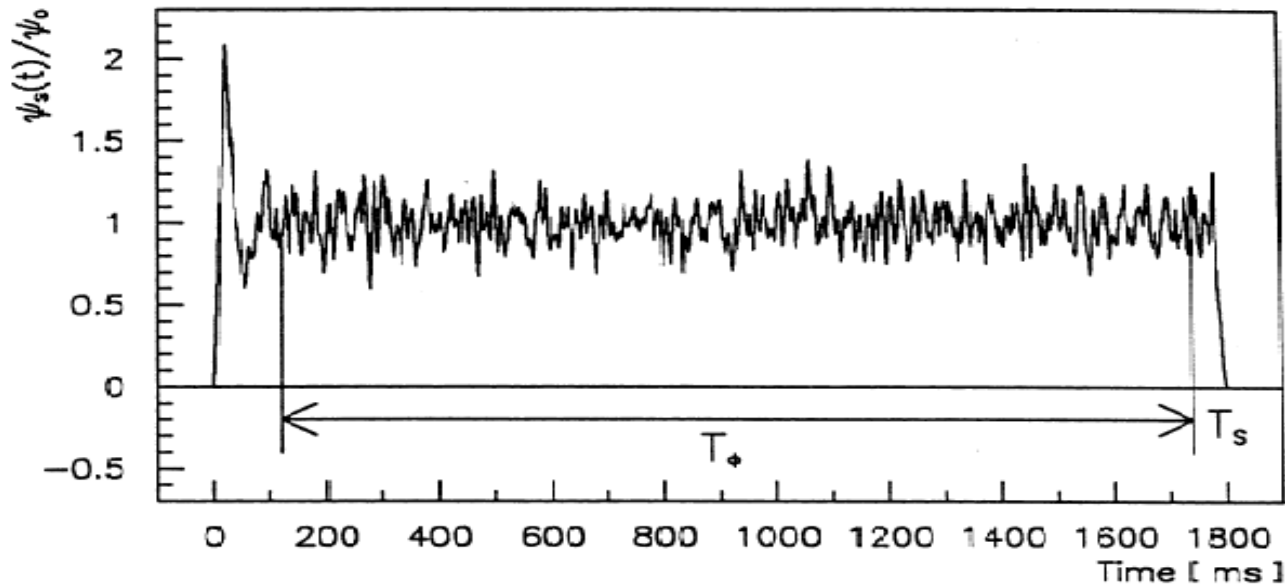

Intensity vs time:  
 $\sim 10^8$  p+ extracted per turn

# Second-order resonant extraction

- An extraction can also be made over a few hundred turns
- 2<sup>nd</sup> and 4<sup>th</sup> order resonances
  - Octupole fields distort the regular phase space particle trajectories.
  - Stable area defined, delimited by two unstable Fixed Points.
  - Beam tune brought across a 2<sup>nd</sup> order resonance ( $Q \rightarrow 0.5$ )
  - Particle amplitudes quickly grow and beam is extracted in a few hundred turns.



# Resonant extraction separatrices

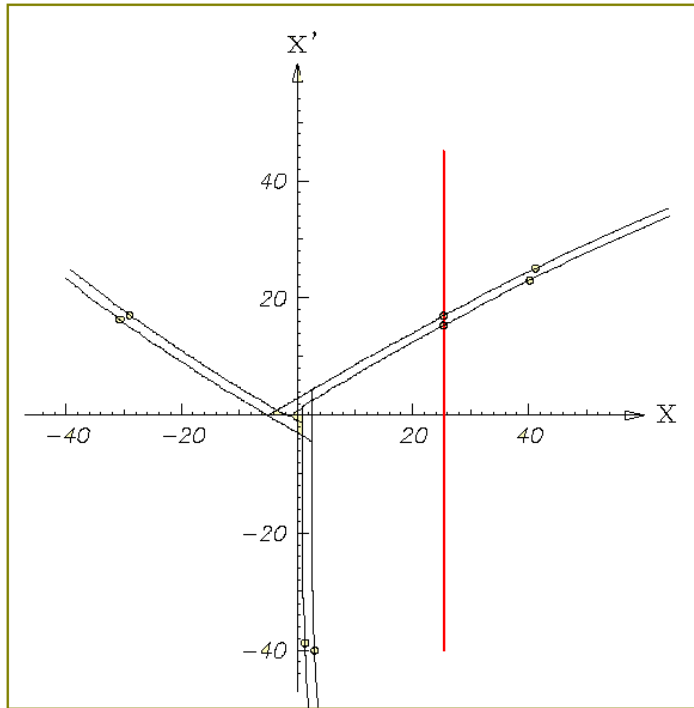

$\bar{X}'$  3<sup>rd</sup> order resonant extraction

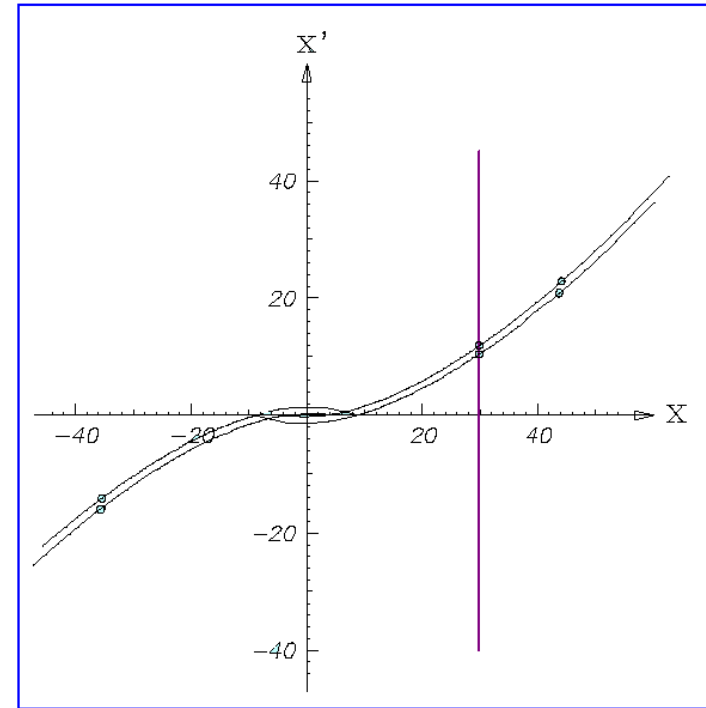
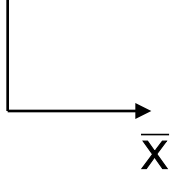

2<sup>nd</sup> order resonant extraction

- Amplitude growth for 2<sup>nd</sup> order resonance much faster than 3<sup>rd</sup> – shorter spill
- Used where intense pulses are required on target – e.g. neutrino production

# Resonant low-loss multi-turn extraction

- Adiabatic capture of beam in stable “islands”
  - Use non-linear fields (sextupoles and octupoles) to create islands of stability in phase space
  - A slow (adiabatic) tune variation to cross a resonance and to drive particles into the islands (capture)
  - Variation of field strengths to separate the islands in phase space
- Several big advantages
  - Losses reduced virtually to zero (no particles at the septum)
  - Phase space matching improved with respect to existing non-resonant multi-turn extraction - all ‘beamlets’ have same emittance and optical parameters

# Resonant low-loss multi-turn extraction

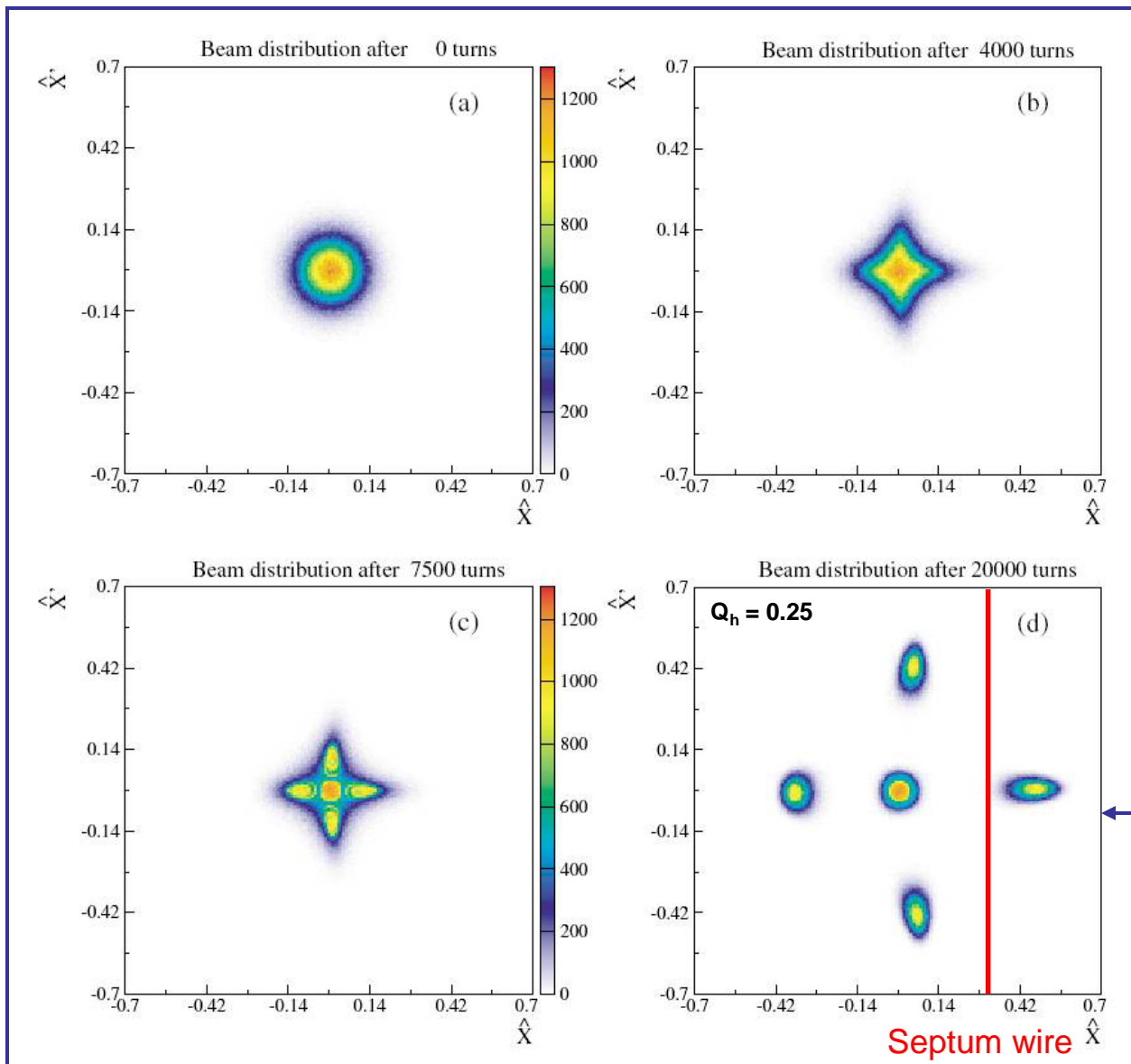

- Unperturbed beam
- Increasing non-linear fields
- Beam captured in stable islands
- Islands separated and beam bumped across septum – extracted in 5 turns

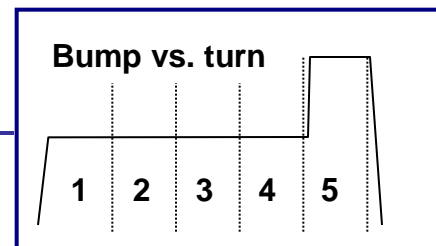

# Extraction - summary

- Several different techniques:
  - Single-turn fast extraction:
    - for Boxcar stacking (transfer between machines in accelerator chain), beam abort
  - Non-resonant multi-turn extraction
    - slice beam into equal parts for transfer between machine over a few turns.
  - Resonant multi-turn extraction
    - create stable area in phase space  $\Rightarrow$  slowly drive particles into resonance  $\Rightarrow$  long spill over many thousand turns.
  - Resonant low-loss multi-turn extraction
    - create stable islands in phase space: slice off over a few turns.