

Multi-Bunch Feedback Systems



H. Schmickler, CERN, CAS 2018 Tuusula (FI)

Special thanks to Marco Lonza for leaving most of his slides and animations

- What is feedback?
- What are the applications in accelerators?
- Coupled-bunch instabilities
- Basics of feedback systems
- Feedback system components
- Digital signal processing
- Using feedbacks for beam diagnostics

What means feedback?

open loop
(simple)

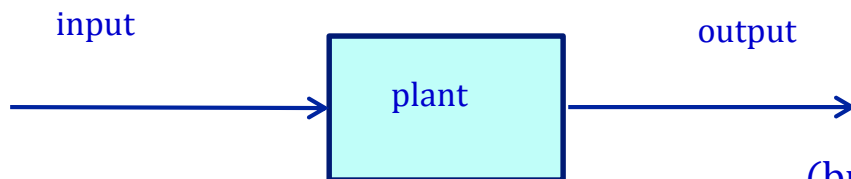

(but) requires
precise knowledge of plant

feed forward

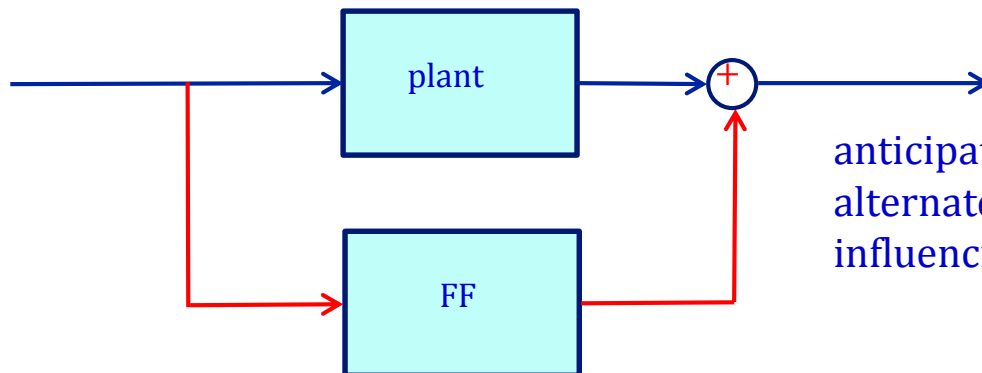

anticipate, requires
alternate means of
influencing output

feedback

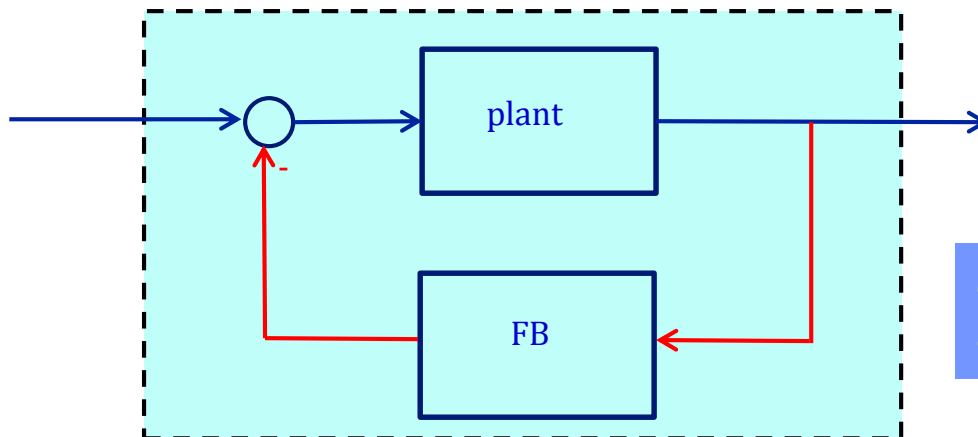

feed back means
influencing the system
output by acting back on
the input

→ new system
→ some new properties

- An accelerator, which relies on active beam feedback to get basic performance, is based on a questionable concept.
Feedbacks should not be used to fix equipment, that can be fixed or redesigned.
- Typically feedbacks are employed to achieve ultimate performance and long term stability.
- Feedbacks are used in the transverse and longitudinal plane.
- We concentrate on feedback systems based **on beam signals** (almost every technical equipment has internal feedback controllers ...power converters, RF systems, instrumentation...)
- Beam feedbacks:
 - 1) Transverse and/or longitudinal damping against beam instabilities
 - 2) Injection damping
 - 3) Slow control of machine parameters (orbit, tune, chromaticity)1 + 2 have hard real time constraints (turn by turn), 3 has lower bandwidth
- Apart from showing one example, we focus on feedback **types 1** and 2

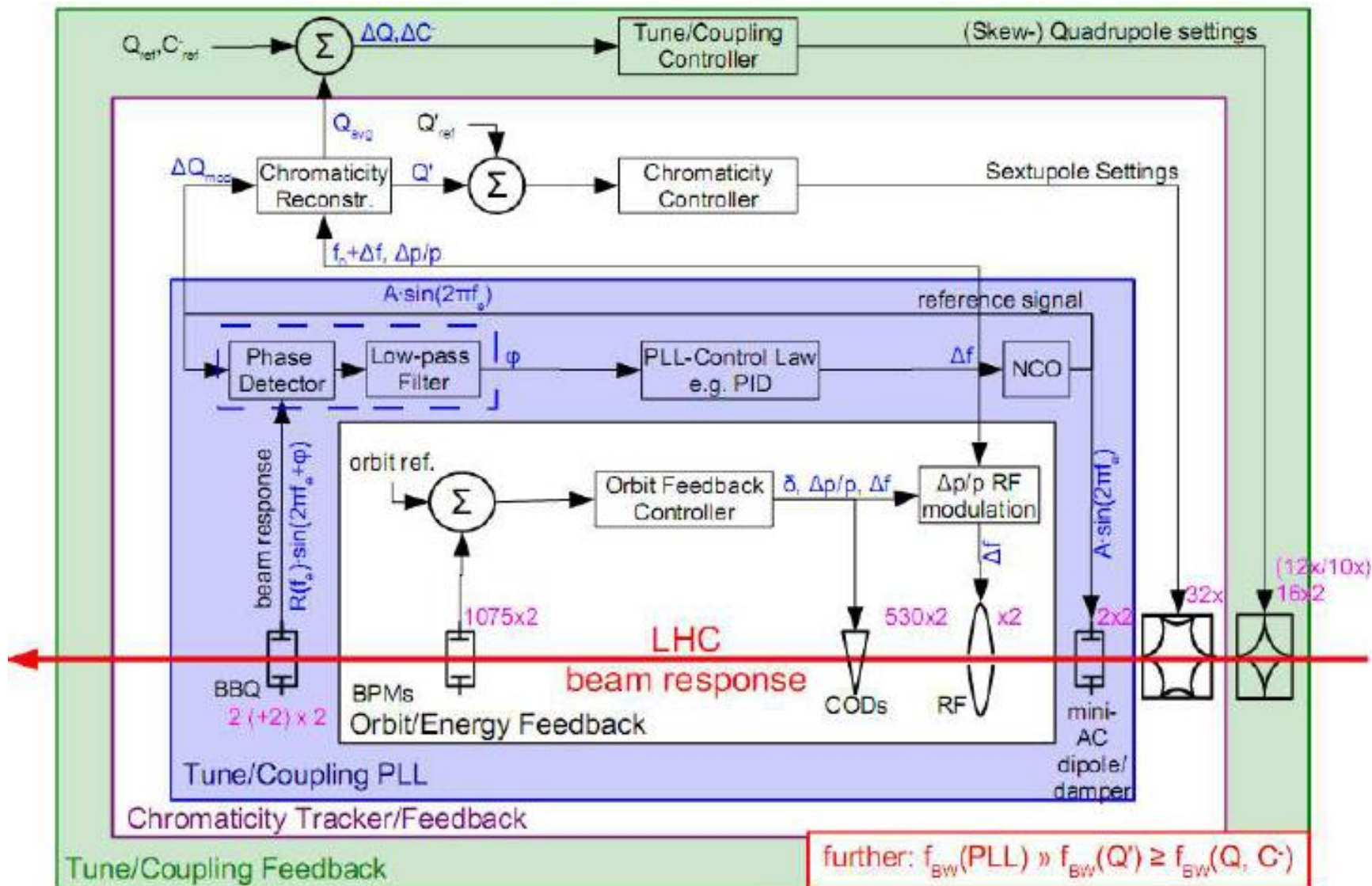

- ▶ Transverse (betatron) and longitudinal (synchrotron) oscillations
 - strongly damped by radiation damping in lepton accelerators (lightsources)
 - undamped in proton accelerators (disregarding 100 TeV designs)
- ▶ Interaction of the electromagnetic field with metallic surroundings ("wake fields")
- ▶ Wake fields act back on the beam and produces growth of oscillations
- ▶ If the growth rate is stronger than the natural damping the oscillation gets unstable
- ▶ Consequences are **emittance increase or particle loss**.
- ▶ Since wake fields are proportional to the bunch charge, the onset of instabilities and their amplitude are normally **current dependent**
- ▶ Another "instability", i.e. large beam oscillation is due to errors at the moment of injection:
 - rather uncritical for lepton machines (radiation damping)
 - vital for hadron machines (filamentation and emittance increase → loss in luminosity)
- ▶ People always aim at higher brightness beams or higher luminosity collisions, which means
 - maximum beam/bunch intensity
 - minimum beam emittance
- ▶ **Sooner or later feedbacks are employed to gain the last factors of performance.**

High intensity proton beam injected into the SPS:

3 ms growth rate
0.5 ms damping time

injection with
damper off

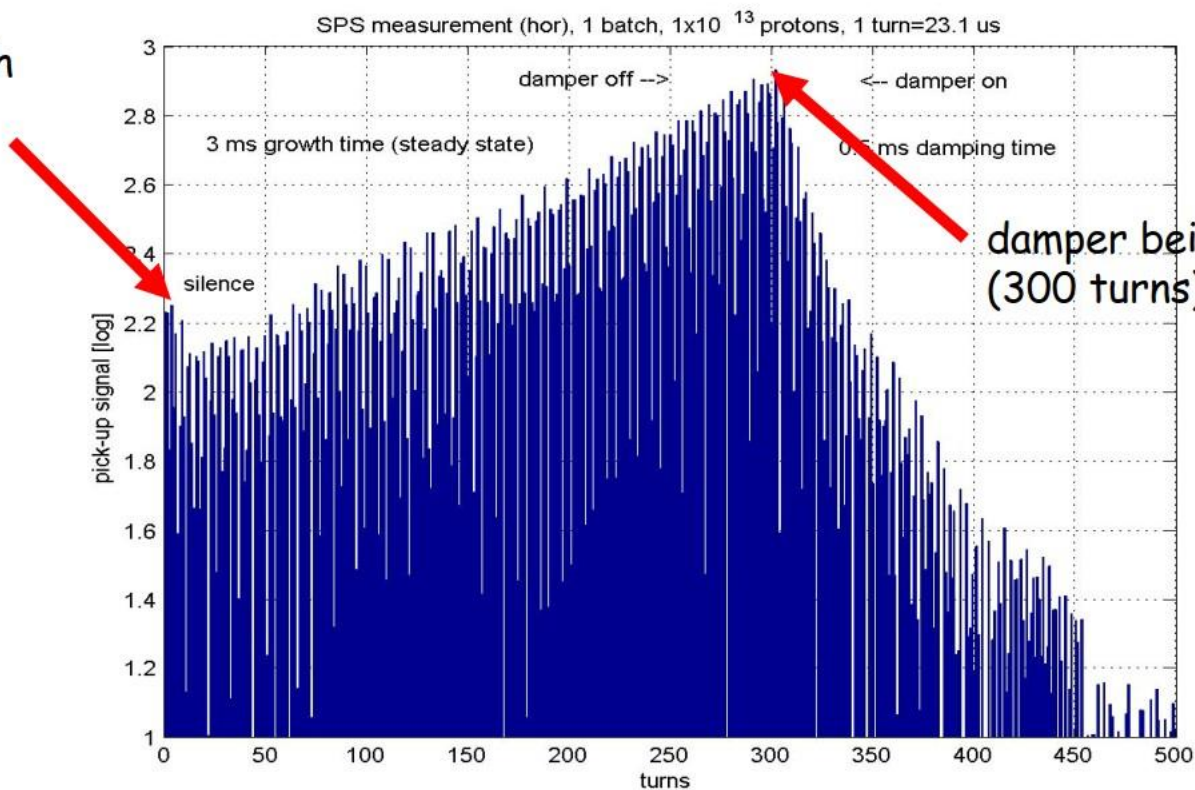

Steering error – non-linear machine

- What will happen to particle distribution and hence emittance?

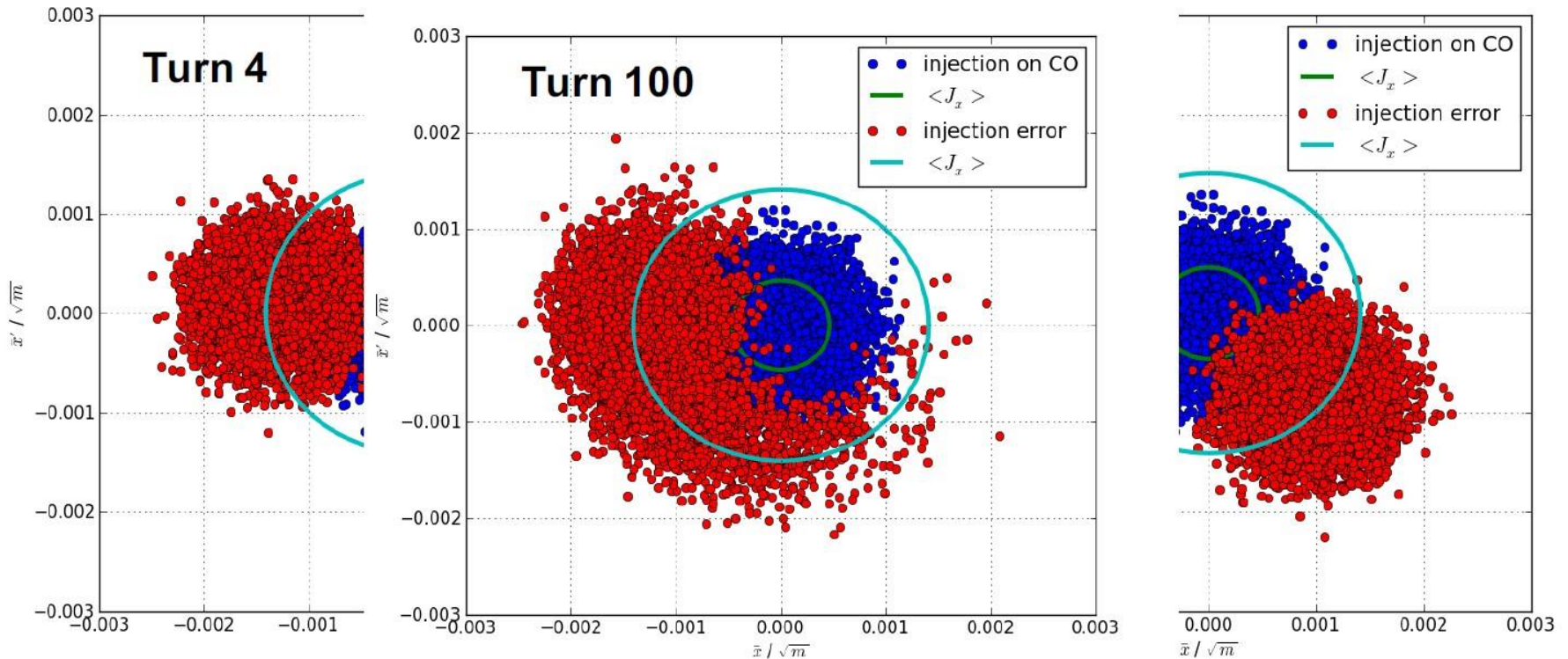

- The beam is filamenting....

Steering error – non-linear machine

- Phase-space after an even longer time

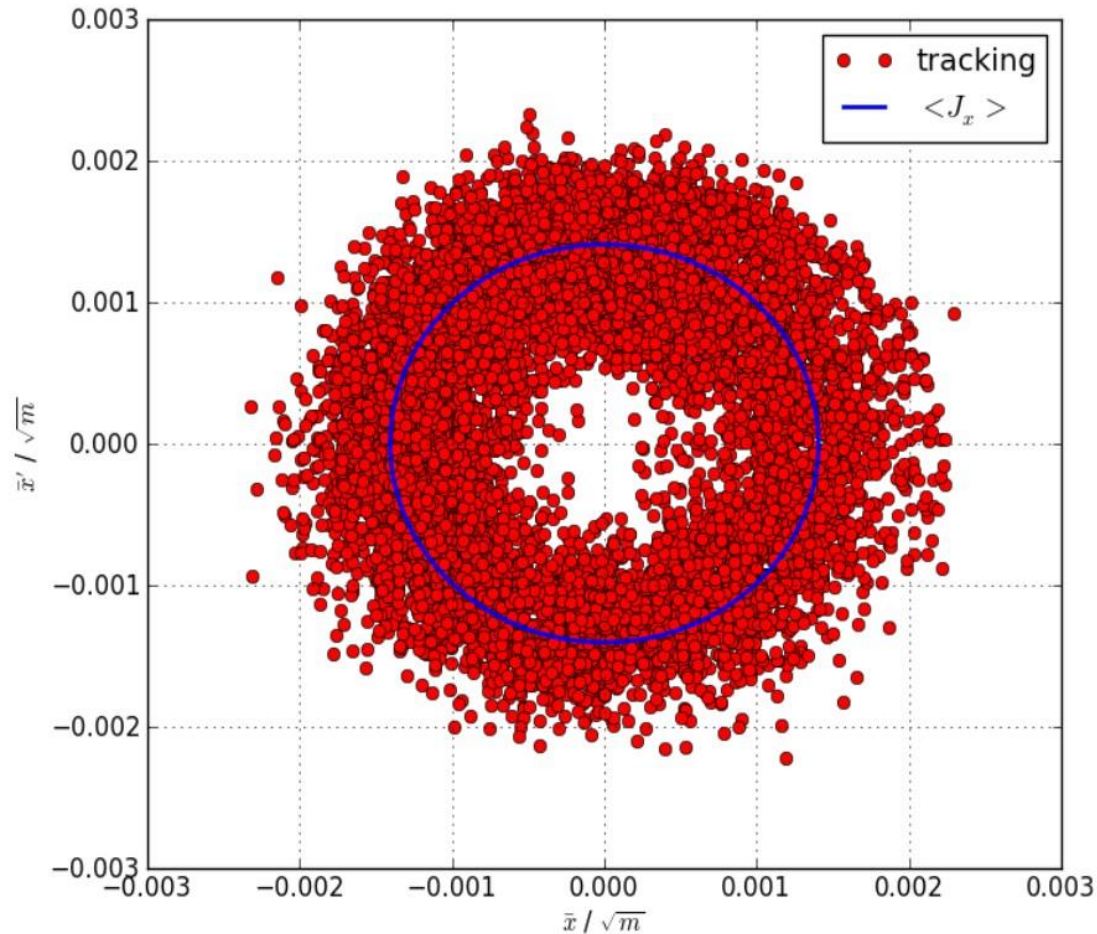

→ Much shorter than the filamentation time, the injection oscillation must be damped.

The feedback action adds a damping term D_{fb} to the equation of motion

$$X''(t) + 2(D-G+D_{fb}) X'(t) + \omega^2 X(t) = 0$$

Such that $D-G+D_{fb} > 0$

A multi-bunch feedback detects an instability by means of one or more Beam Position Monitors (BPM) and acts back on the beam by applying electromagnetic 'kicks' to the bunches

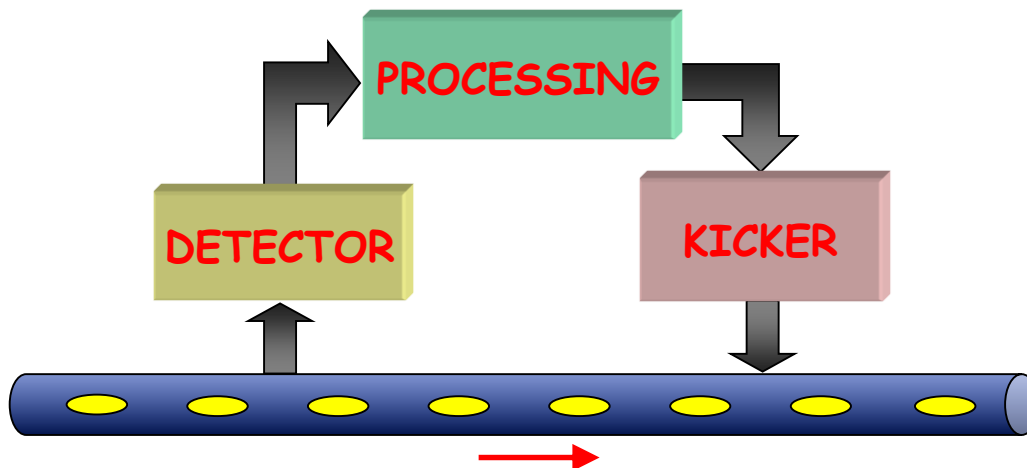

In order to introduce damping, the feedback must provide a kick proportional to the derivative of the bunch oscillation

Since the oscillation is sinusoidal, the kick signal for each bunch can be generated by shifting by $\pi/2$ the oscillation signal of the same bunch when it passes through the kicker

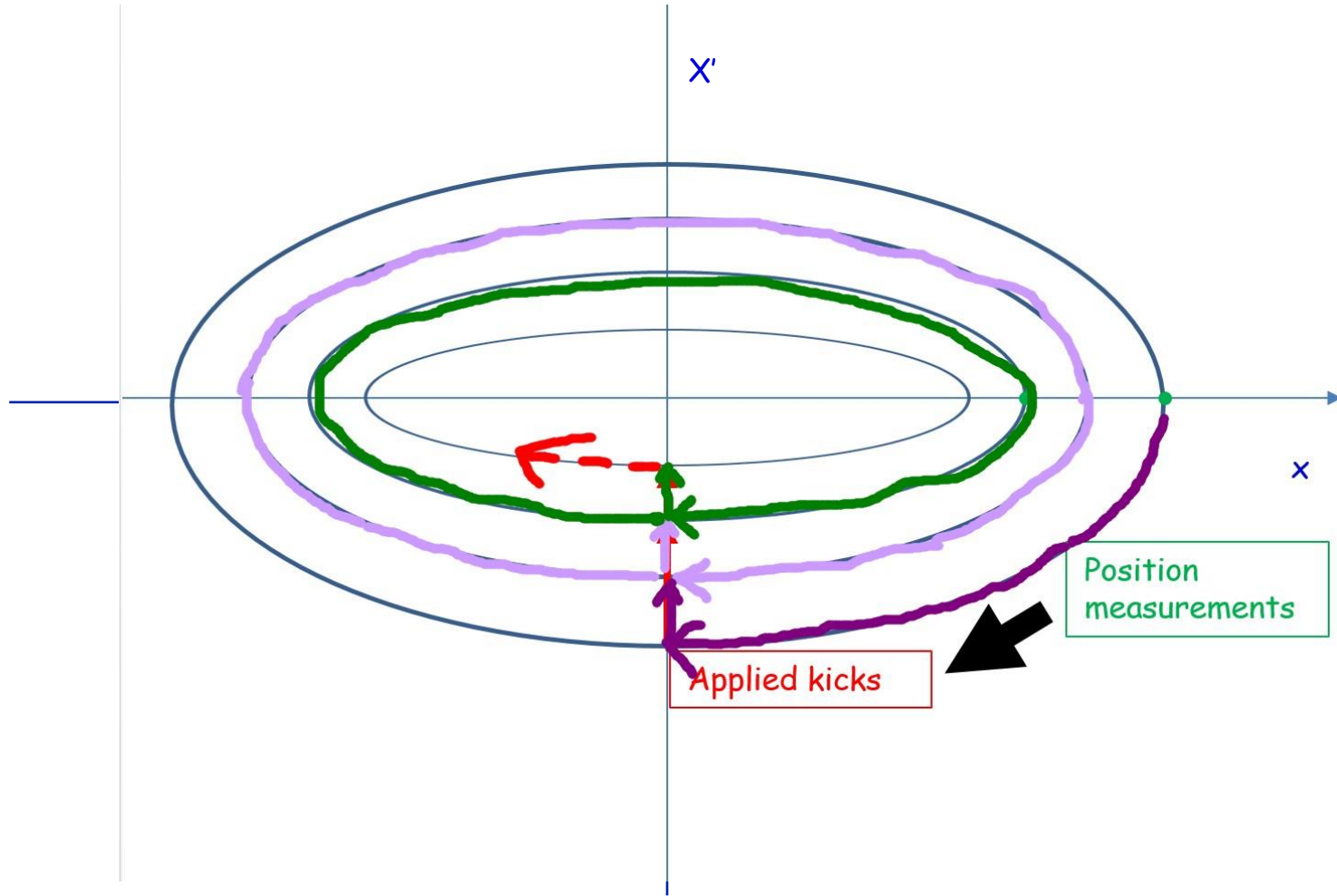

- Why do we distinguish between
 - 1) transverse (multibunch) feedback
 - 2) injection damping
 - 3) intrabunch feedback
- → Identical concept, but
 - Large differences for the required dynamic ranges of components (ADC, DAC, digital processing, actuator strength, bandwidth):
 - 1) assumption that a stable bunch is kept stable; No large position excursions, use ADC range for high resolution position measurements down to small fractions of a beam sigma; moderate actuator power requirements in CW mode
 - 2) Almost inverse requirements to 1) : Large initial amplitudes (exceeding one sigma), Huge peak power on actuator, then no power requirements
 - 3) as 1) but with at least a factor 10 higher bandwidth

Typically, betatron tune frequencies (horizontal and vertical) are higher than the revolution frequency, while the synchrotron tune frequency (longitudinal) is lower than the revolution frequency

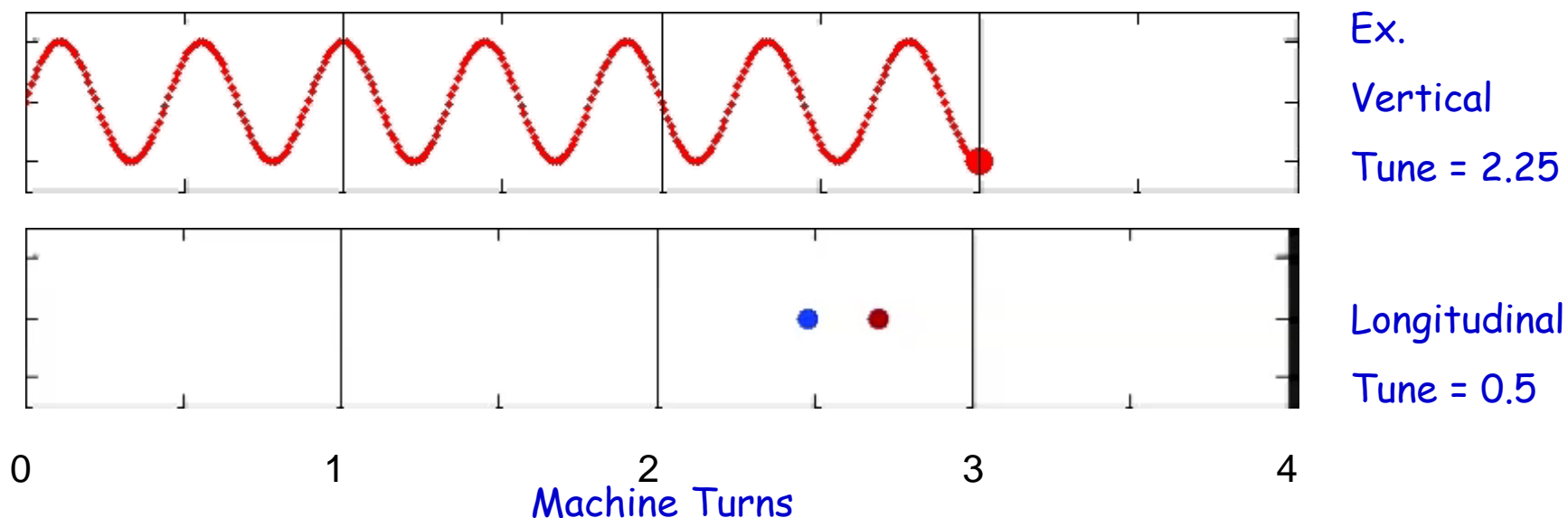

Although each bunch oscillates at the tune frequency, there can be different modes of oscillation, called **multi-bunch modes** depending on how each bunch oscillates with respect to the other bunches

Let us consider M bunches equally spaced around the ring

Each multi-bunch mode is characterized by a bunch-to-bunch phase difference of:

$$\Delta\Phi = m \frac{2\pi}{M} \quad m = \text{multi-bunch mode number } (0, 1, \dots, M-1)$$

Each multi-bunch mode is associated to a characteristic set of frequencies:

$$\omega = pM\omega_0 \pm (m+\nu)\omega_0$$

Where:

p is an integer number $-\infty < p < \infty$

ω_0 is the **revolution frequency**

$M\omega_0 = \omega_{rf}$ is the RF frequency (bunch repetition frequency)

ν is the **tune**

Two sidebands at $\pm(m+\nu)\omega_0$ for each multiple of the RF frequency

The spectrum is a repetition of frequency lines at multiples of the bunch repetition frequency with sidebands at $\pm v\omega_0$: $\omega = p\omega_{rf} \pm v\omega_0 \quad -\infty < p < \infty \quad (v = 0.25)$

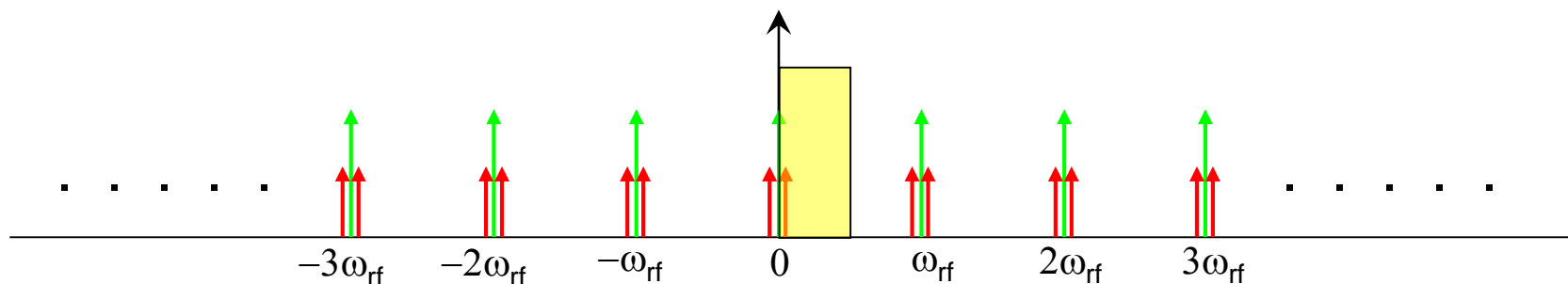

Since the spectrum is periodic and each mode appears twice (upper and lower side band) in a ω_{rf} frequency span, we can limit the spectrum analysis to a $0-\omega_{rf}/2$ frequency range

The inverse statement is also true:

Since we 'sample' the continuous motion of the beam with only one pickup, any other frequency component above half the 'sampling frequency' (i.e the bunch frequency ω_{rf}) is not accessible (Nyquist or Shannon Theorem)

Vertical plane. One single stable bunch

Pickup position

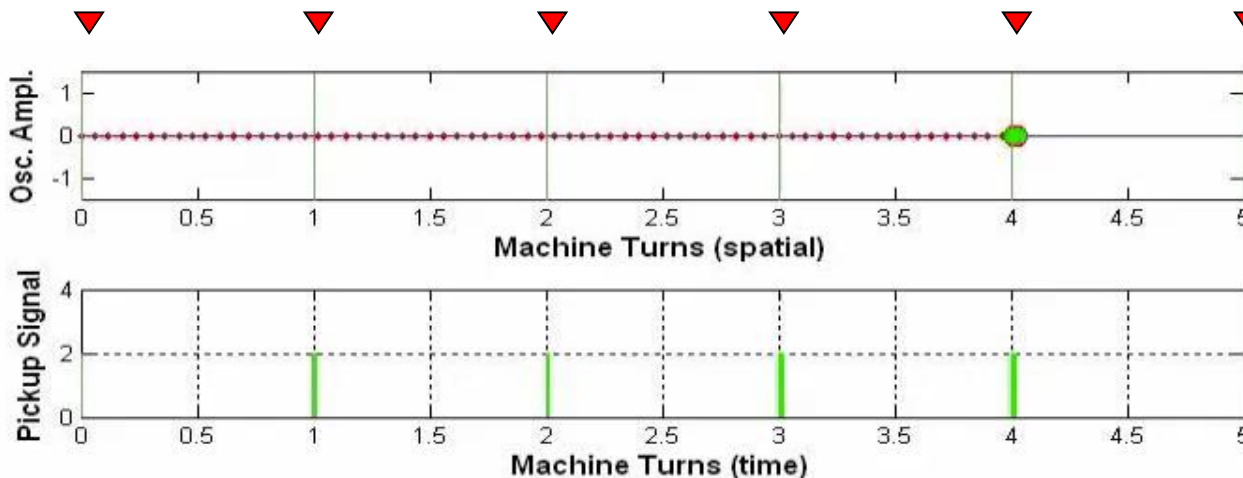

Every time the bunch passes through the pickup (\blacktriangledown) placed at coordinate 0, a pulse with constant amplitude is generated. If we think it as a Dirac impulse, the spectrum of the pickup signal is a repetition of frequency lines at multiple of the revolution frequency: $p\omega_0$ for $-\infty < p < \infty$

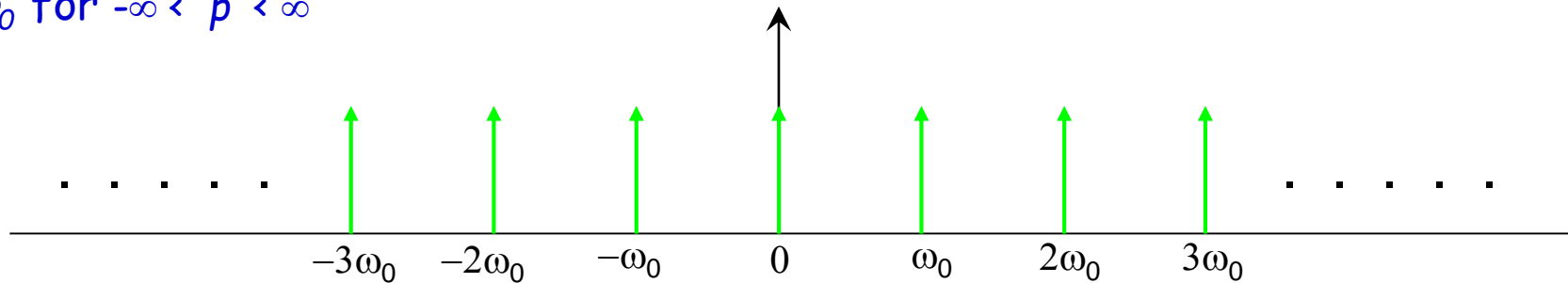

Multi-bunch modes: example2

One single unstable bunch oscillating at the tune frequency $\nu\omega_0$: for simplicity we consider a vertical tune $\nu < 1$, ex. $\nu = 0.25$. $M = 1 \rightarrow$ only mode #0 exists

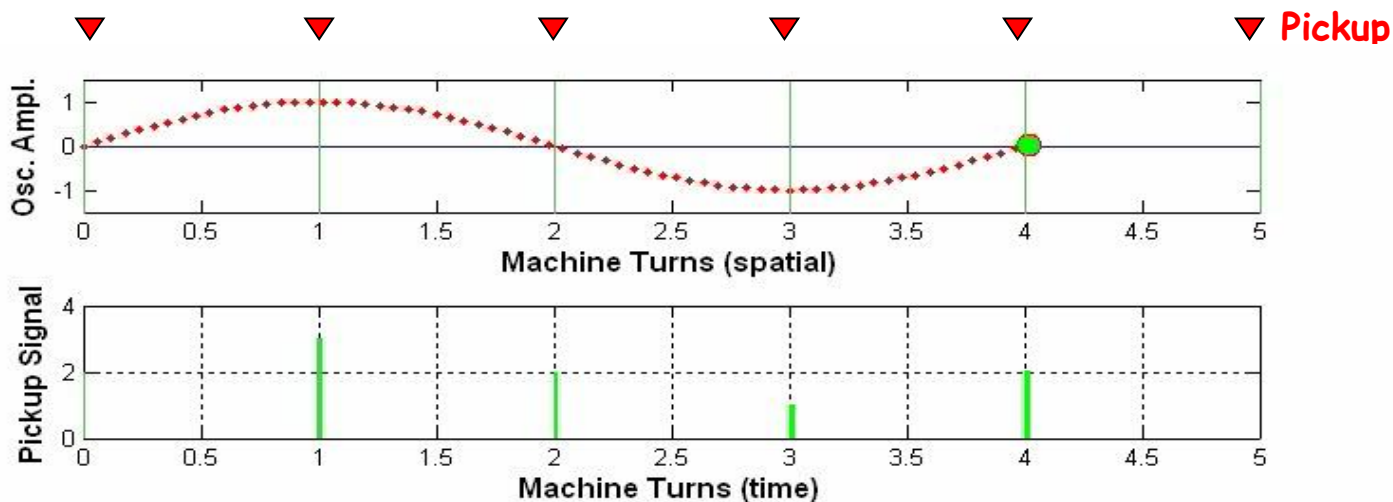

The pickup signal is a sequence of pulses modulated in amplitude with frequency $\nu\omega_0$
 Two sidebands at $\pm\nu\omega_0$ appear at each of the revolution harmonics

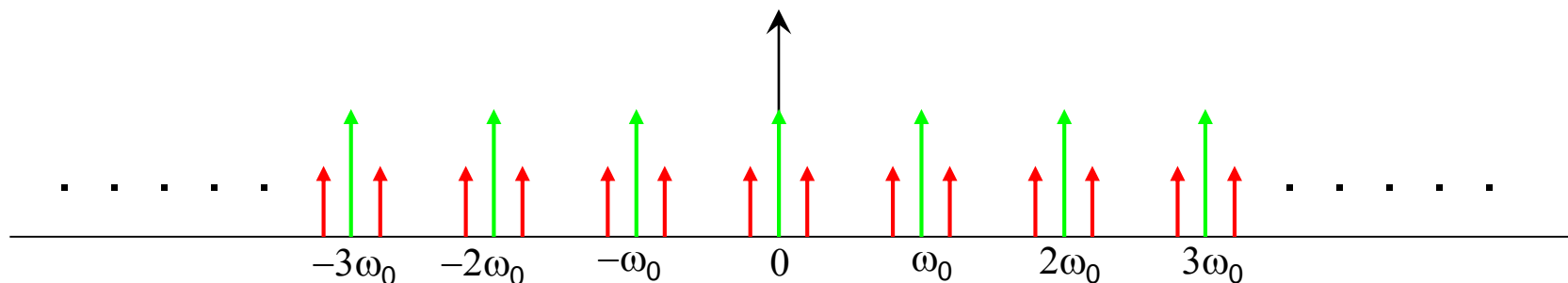

Multi-bunch modes: example3

Ten identical equally-spaced stable bunches filling all the ring buckets ($M = 10$)

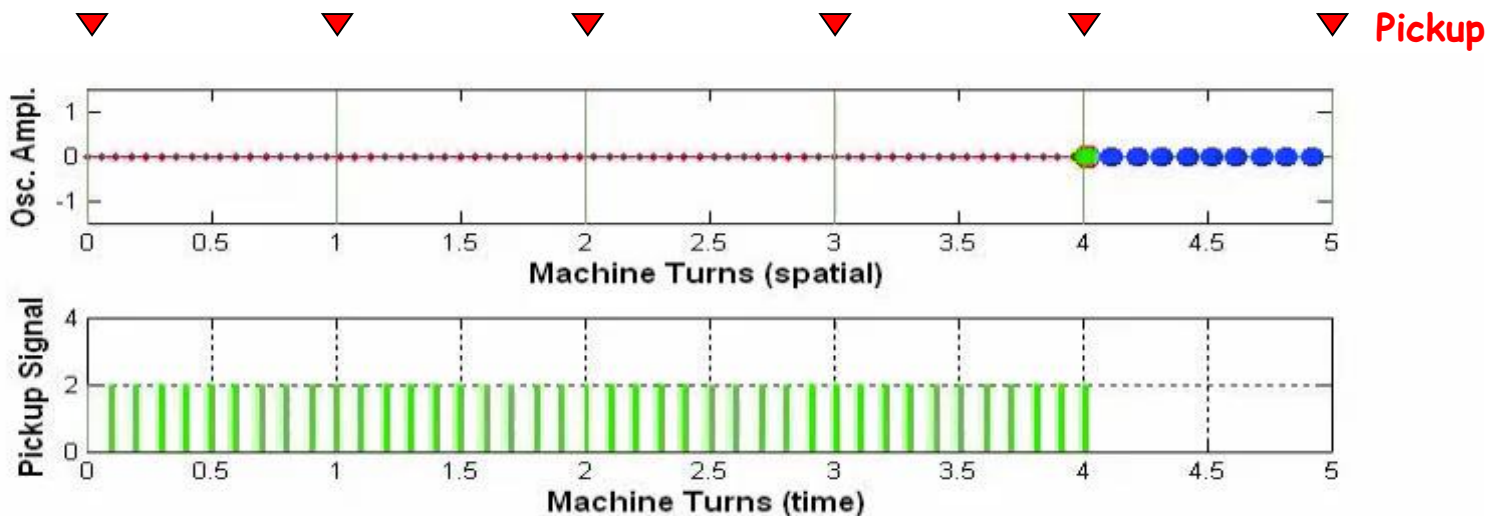

The spectrum is a repetition of frequency lines at multiples of the bunch repetition frequency:
 $\omega_{rf} = 10 \omega_0$ (RF frequency)

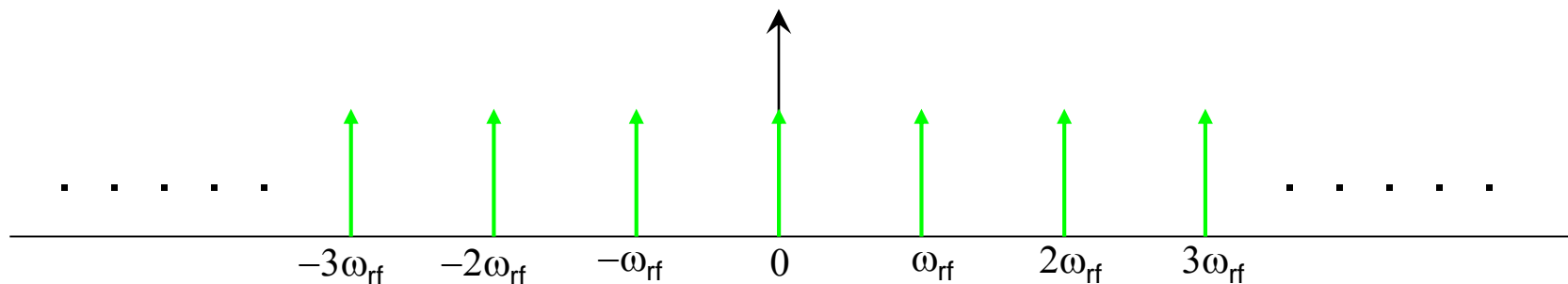

Multi-bunch modes: example4

Ten identical equally-spaced unstable bunches oscillating at the tune frequency $\nu\omega_0$ ($\nu = 0.25$)

$M = 10 \rightarrow$ there are 10 possible modes of oscillation

$$\Delta\Phi = m \frac{2\pi}{M} \quad m = 0, 1, \dots, M-1$$

Ex.: mode #0 ($m = 0$) $\Delta\Phi=0$ all bunches oscillate with the same phase

Pickup

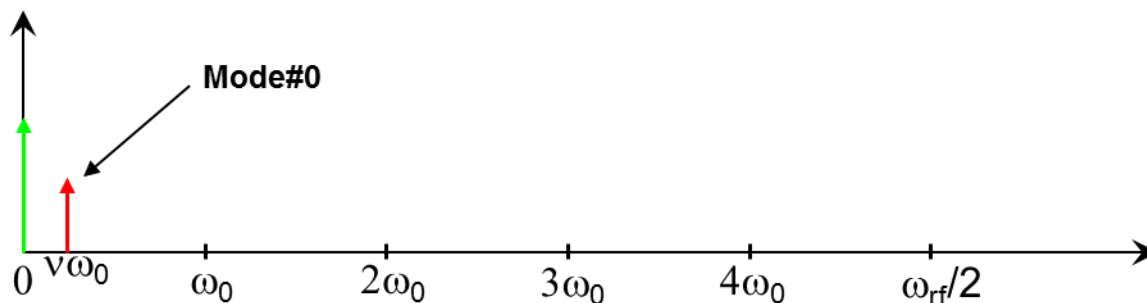
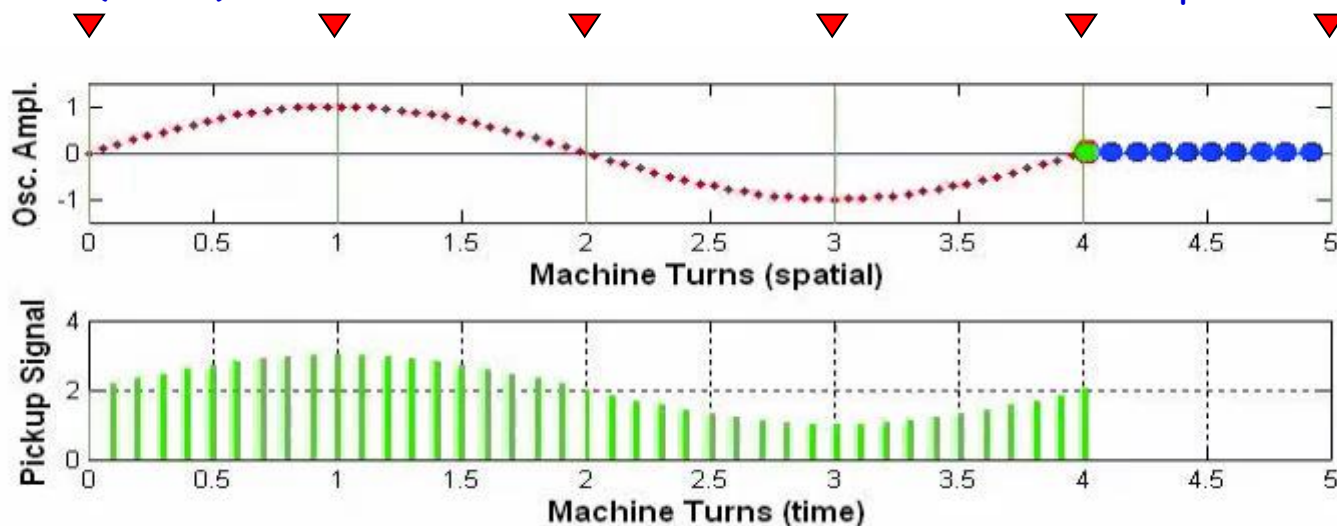

Multi-bunch modes: example5

Ex.: mode #1 ($m = 1$) $\Delta\Phi = 2\pi/10$ ($\nu = 0.25$)

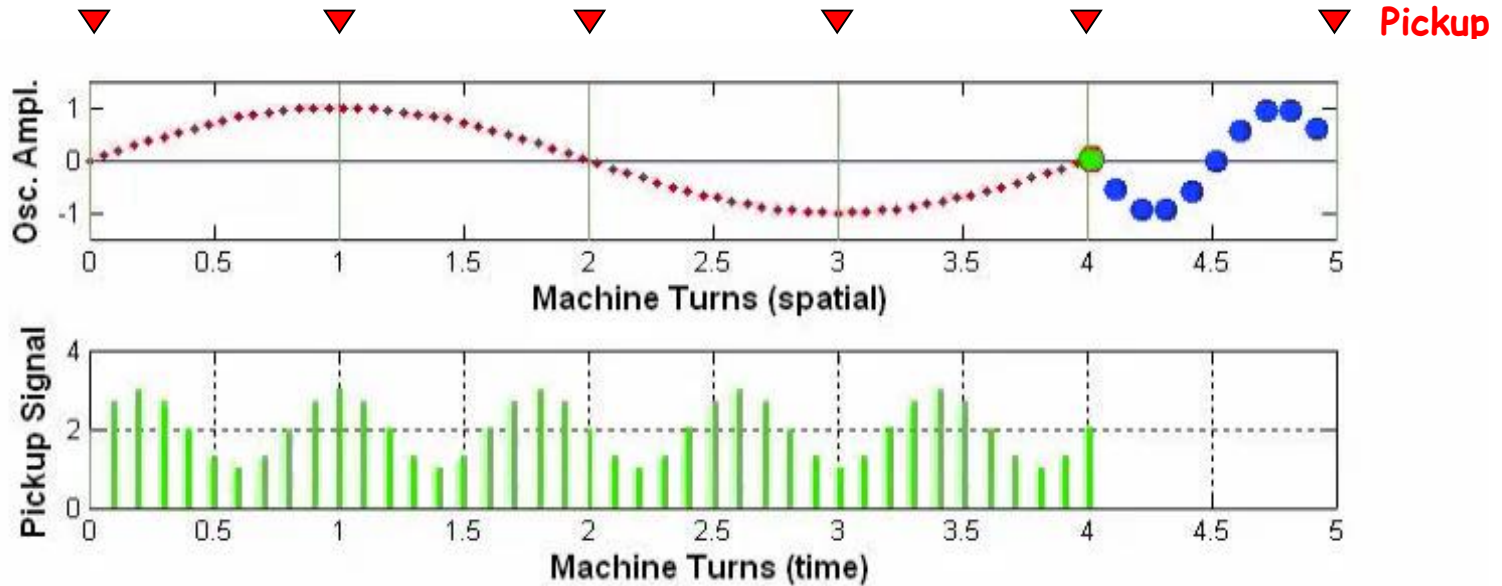

$$\omega = p\omega_{rf} \pm (\nu+1)\omega_0 \quad -\infty < p < \infty$$

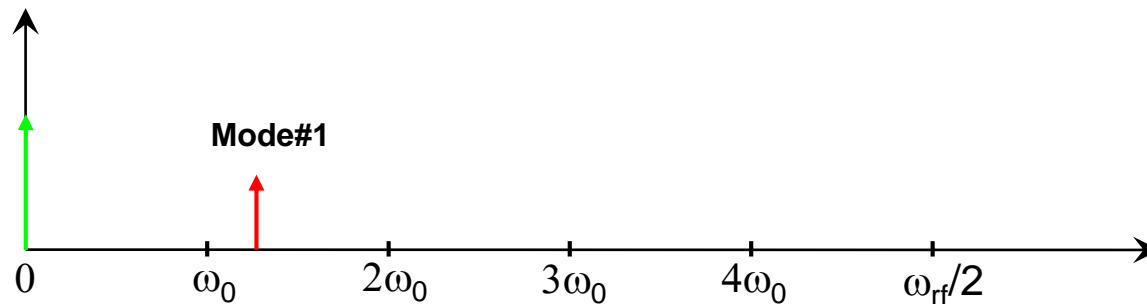

Multi-bunch modes: example 6

Ex.: mode #2 ($m = 2$) $\Delta\Phi = 4\pi/10$ ($\nu = 0.25$)

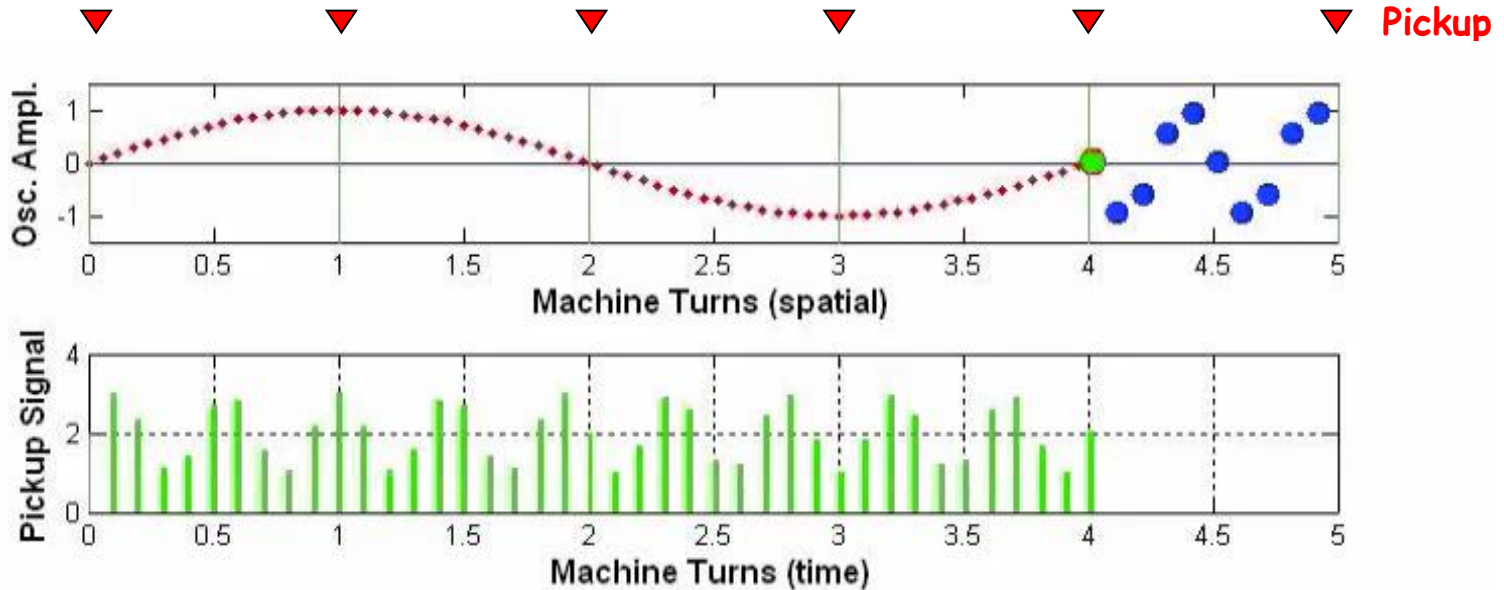

$$\omega = p\omega_{rf} \pm (\nu+2)\omega_0 \quad -\infty < p < \infty$$

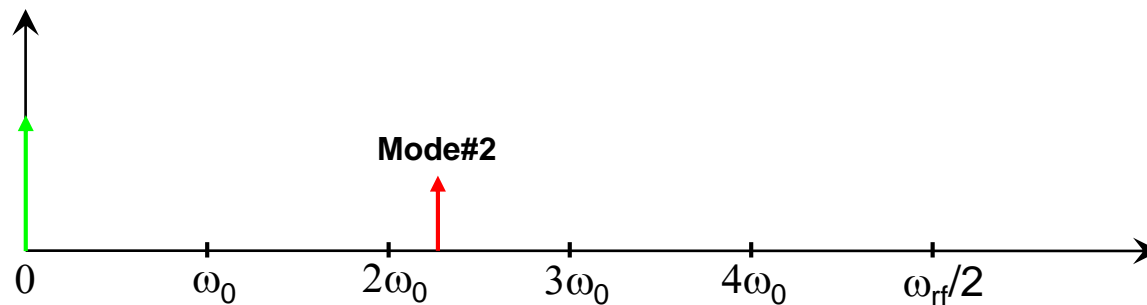

Multi-bunch modes: example7

Ex.: mode #3 ($m = 3$) $\Delta\Phi = 6\pi/10$ ($\nu = 0.25$)

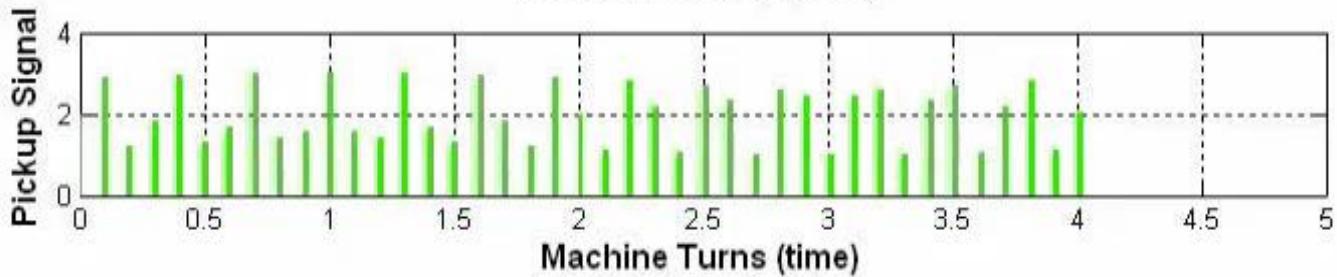
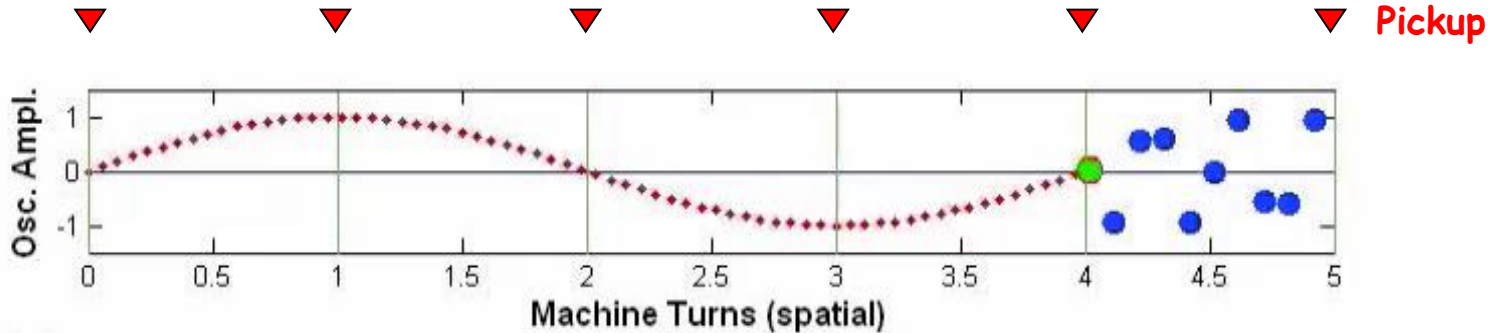

$$\omega = p\omega_{rf} \pm (\nu+3)\omega_0 \quad -\infty < p < \infty$$

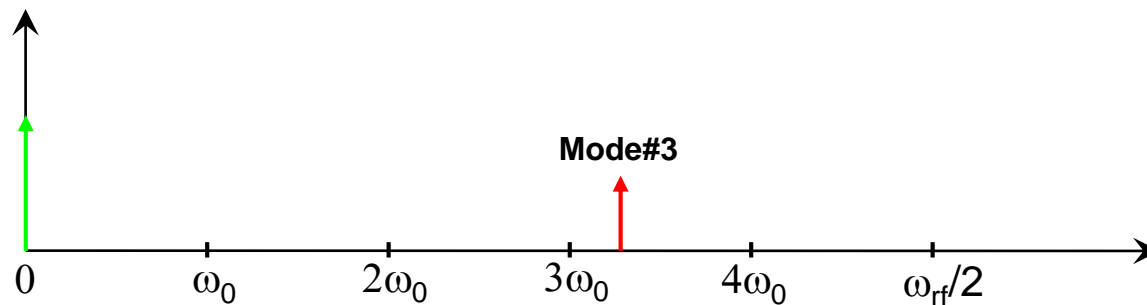

Multi-bunch modes: example8

Ex.: mode #4 ($m = 4$) $\Delta\Phi = 8\pi/10$ ($\nu = 0.25$)

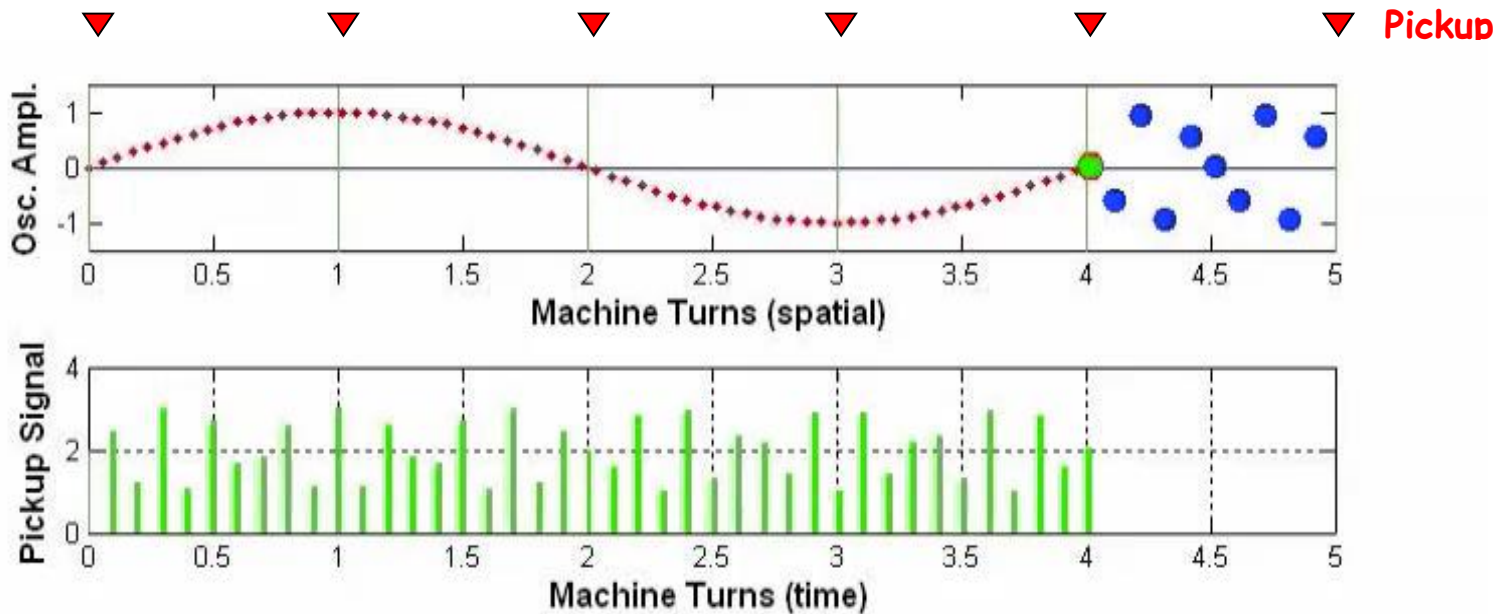

$$\omega = p\omega_{rf} \pm (\nu+4)\omega_0 \quad -\infty < p < \infty$$

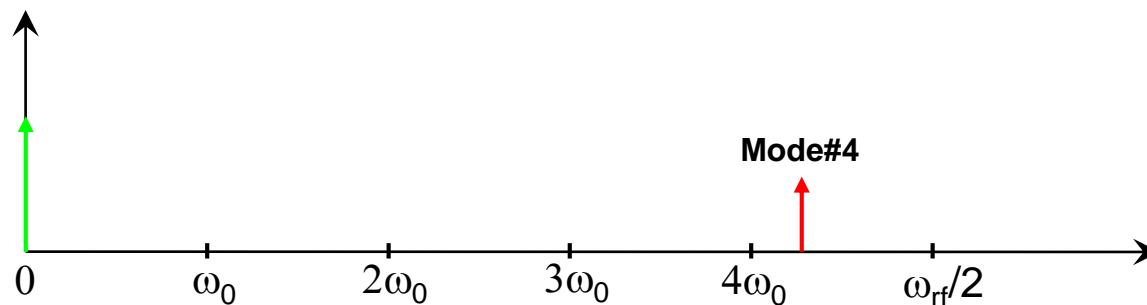

Multi-bunch modes: example9

Ex.: mode #5 ($m = 5$) $\Delta\Phi = \pi$ ($\nu = 0.25$)

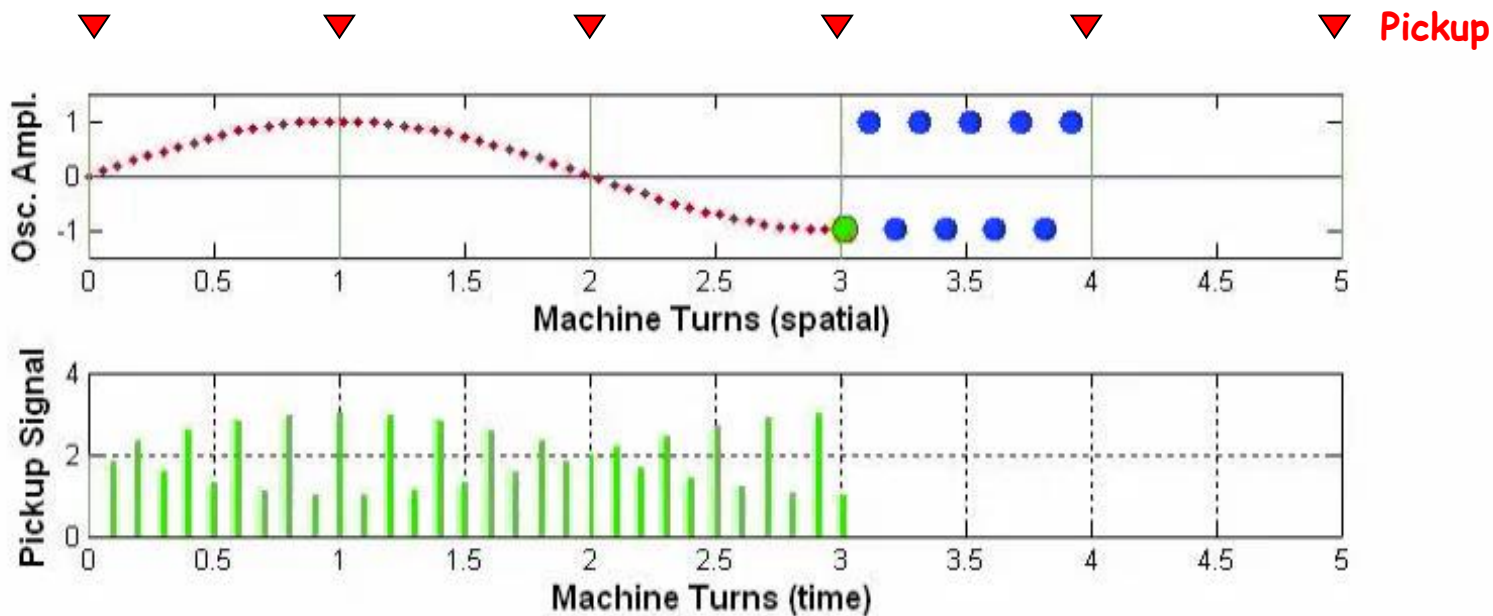

$$\omega = p\omega_{rf} \pm (\nu+5)\omega_0 \quad -\infty < p < \infty$$

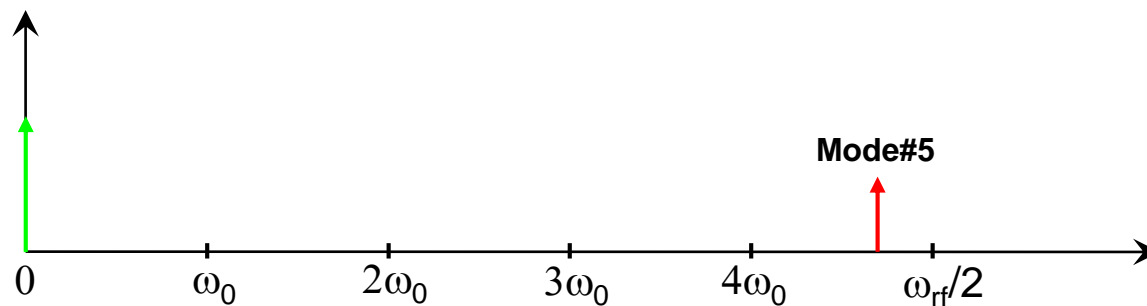

Multi-bunch modes: example10

Ex.: mode #6 ($m = 6$) $\Delta\Phi = 12\pi/10$ ($\nu = 0.25$)

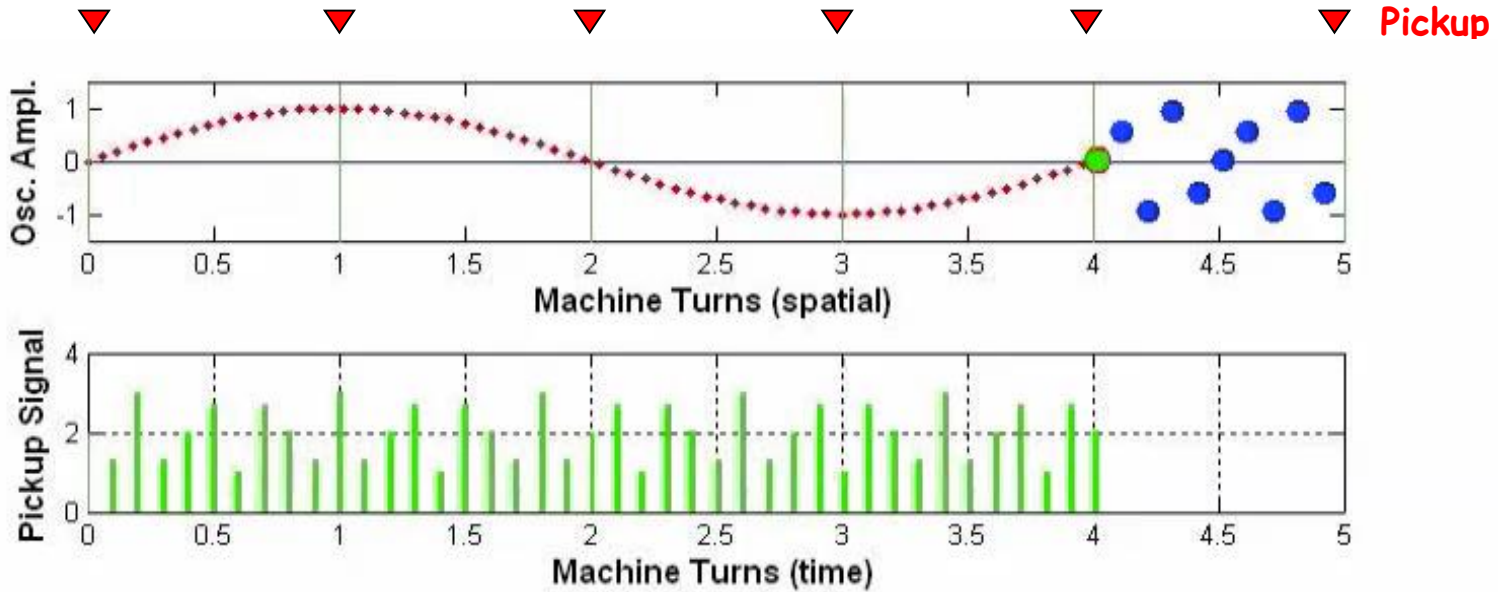

$$\omega = p\omega_{rf} \pm (\nu+6)\omega_0 \quad -\infty < p < \infty$$

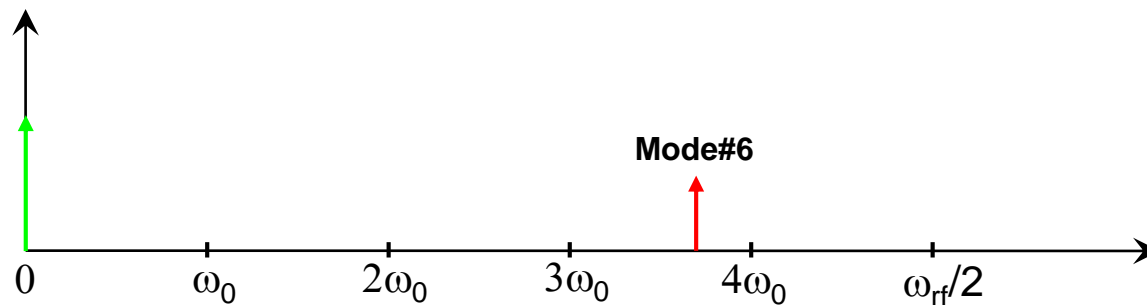

Multi-bunch modes: example11

Ex.: mode #7 ($m = 7$) $\Delta\Phi = 14\pi/10$ ($\nu = 0.25$)

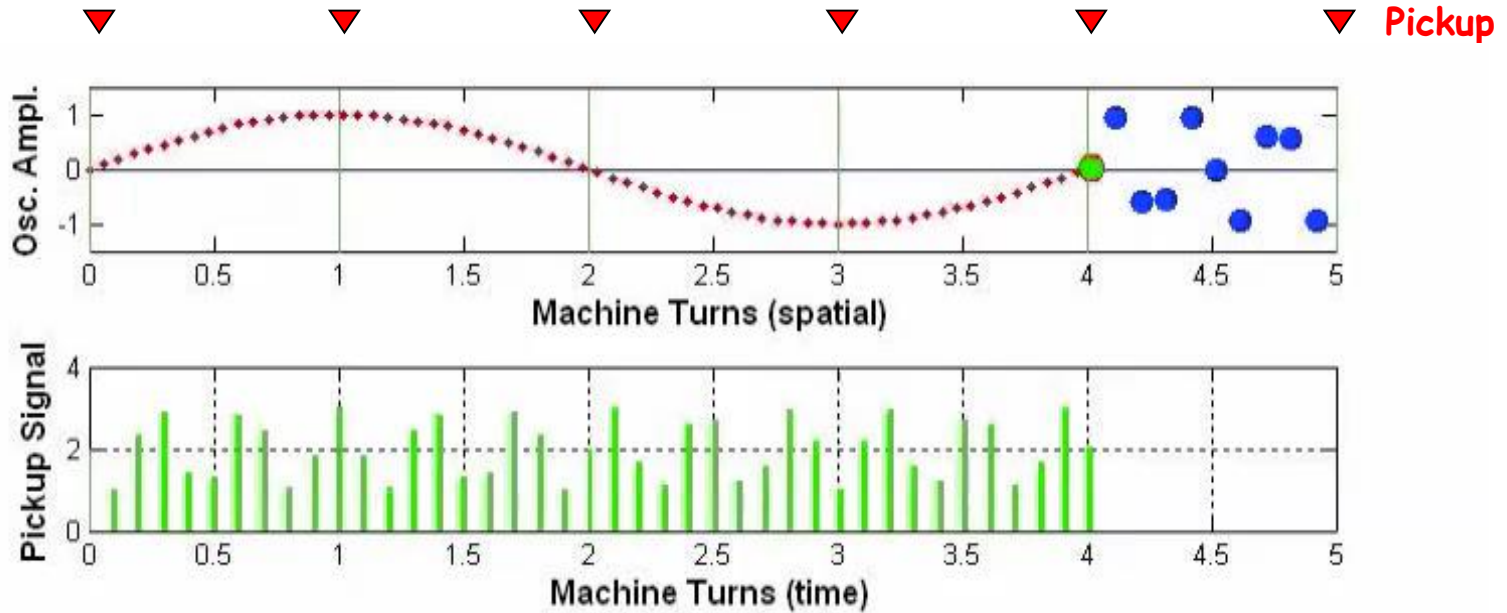

$$\omega = p\omega_{rf} \pm (\nu+7)\omega_0 \quad -\infty < p < \infty$$

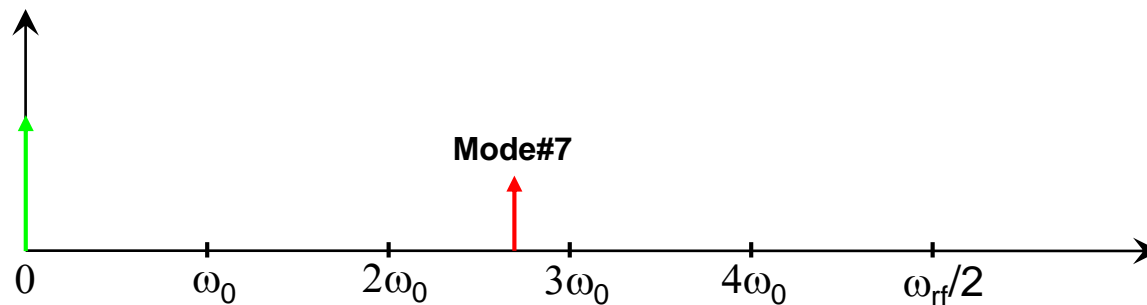

Multi-bunch modes: example12

Ex.: mode #8 ($m = 8$) $\Delta\Phi = 16\pi/10$ ($\nu = 0.25$)

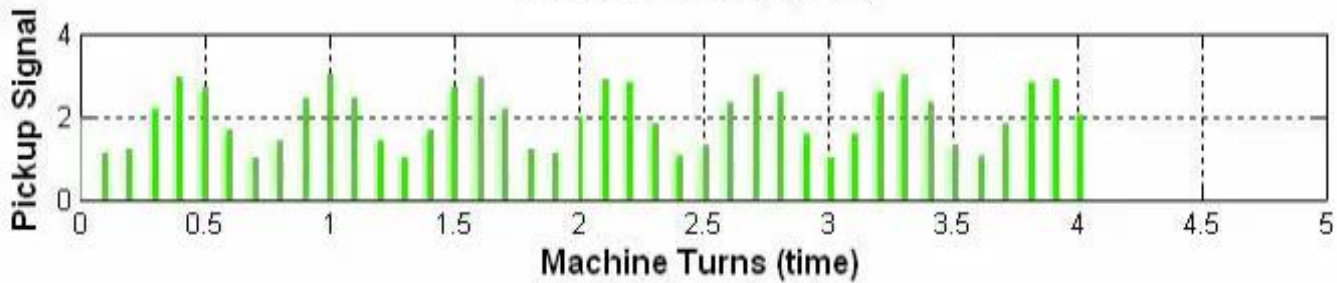
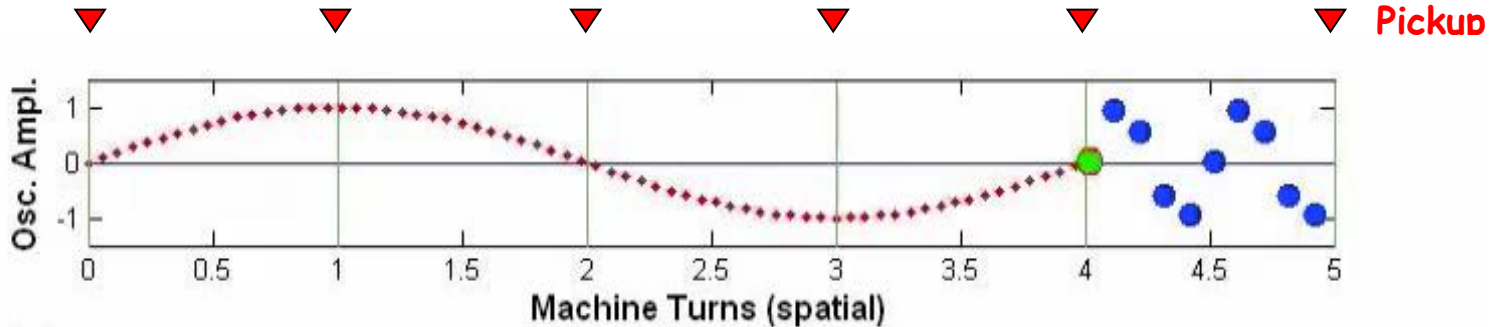

$$\omega = p\omega_{rf} \pm (\nu+8)\omega_0 \quad -\infty < p < \infty$$

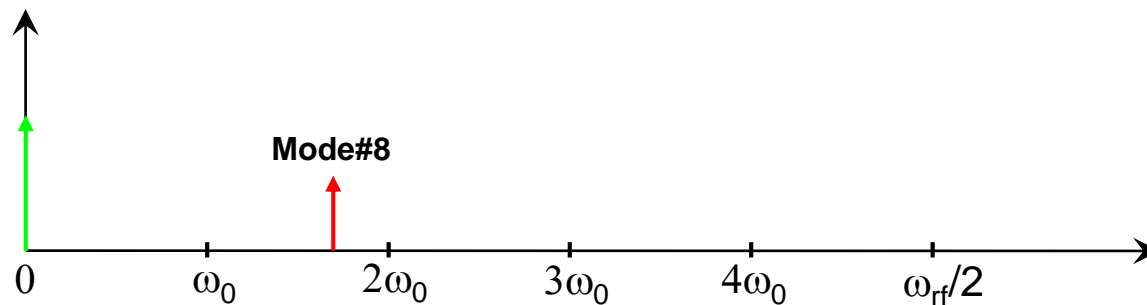

Multi-bunch modes: example13

Ex.: mode #9 ($m = 9$) $\Delta\Phi = 18\pi/10$ ($\nu = 0.25$)

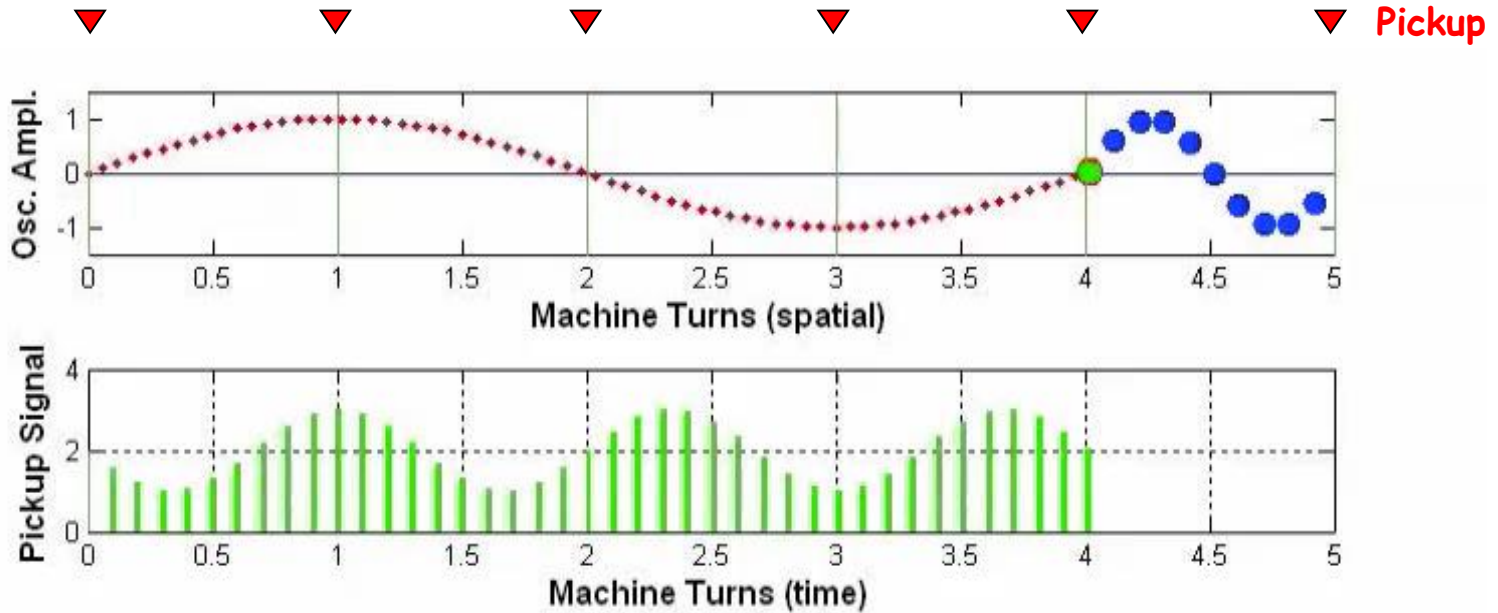

$$\omega = p\omega_{rf} \pm (\nu+9)\omega_0 \quad -\infty < p < \infty$$

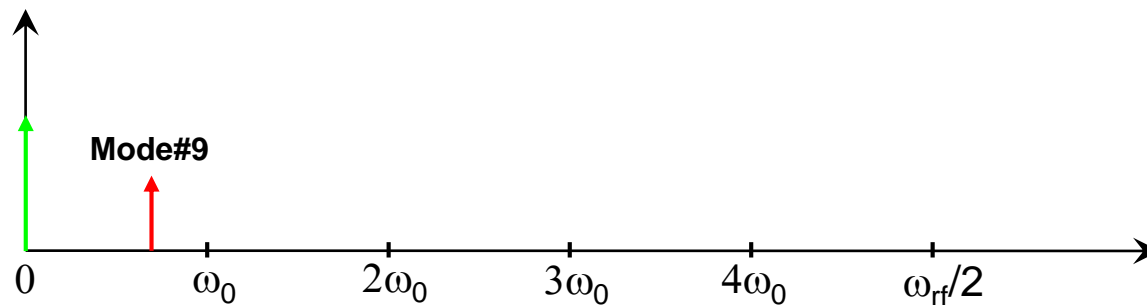

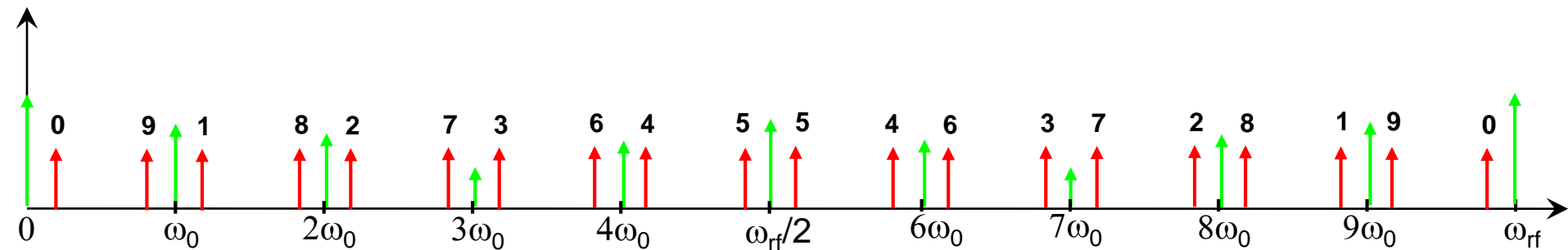

If the bunches have **not the same charge**, i.e. the buckets are not equally filled (uneven filling), the spectrum has frequency **components also at the revolution harmonics** (multiples of ω_0). The amplitude of each revolution harmonic depends on the filling pattern of one machine turn

ELETTRA Synchrotron: $f_{rf}=499.654$ MHz, bunch spacing ≈ 2 ns, 432 bunches, $f_0 = 1.15$ MHz

$\nu_{hor} = 12.30$ (fractional tune frequency = 345 kHz),

$\nu_{vert} = 8.17$ (fractional tune frequency = 200 kHz)

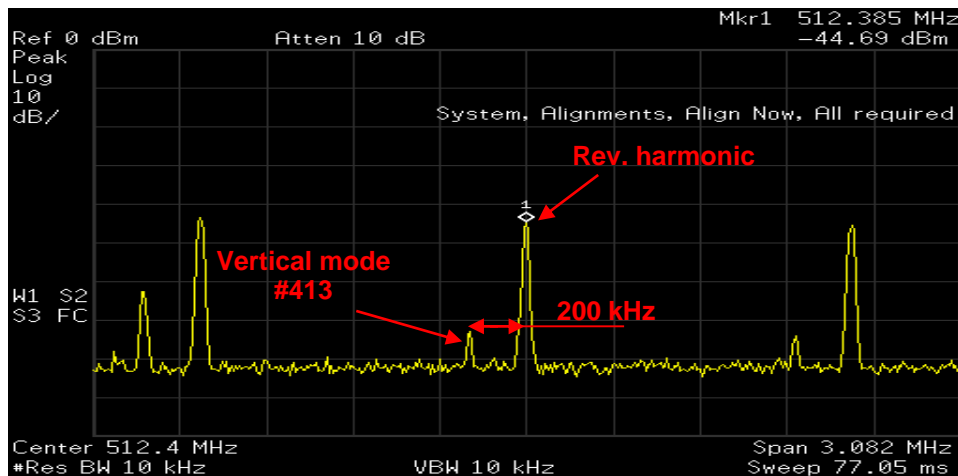

$$\omega = pM\omega_0 \pm (m+\nu)\omega_0$$

Spectral line at 512.185 MHz

Lower sideband of $2f_{rf}$, 200 kHz apart from the 443rd revolution harmonic

→ vertical mode #413

A multi-bunch feedback system detects the instability using one or more Beam Position Monitors (BPM) and acts back on the beam to damp the oscillation through an electromagnetic actuator called **kicker**

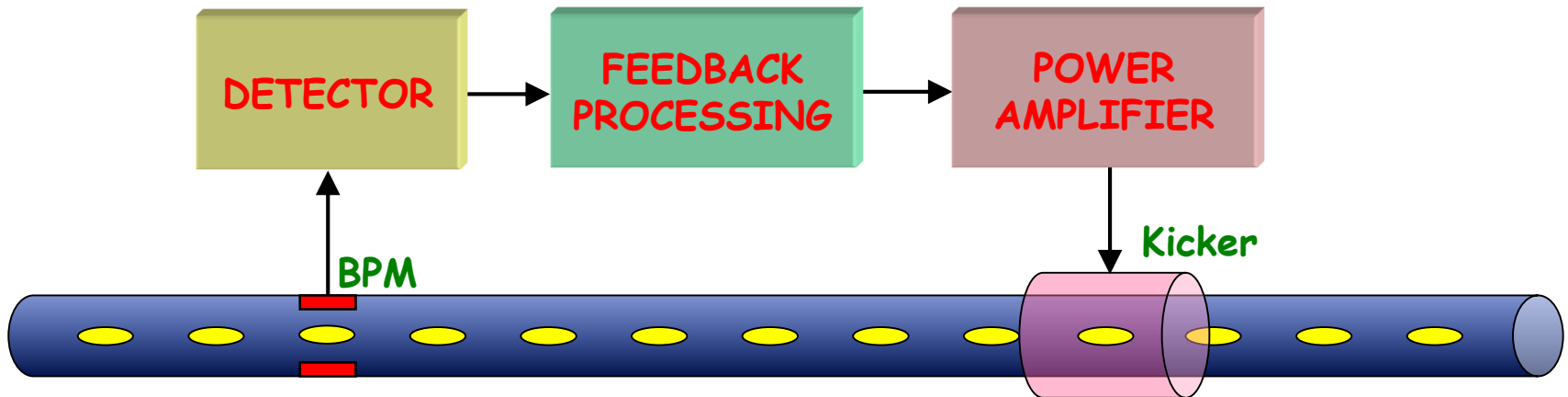

BPM and detector measure the beam oscillations

The feedback processing unit generates the correction signal

The RF power amplifier amplifies the signal

The kicker generates the electromagnetic field

A **mode-by-mode** (frequency domain) feedback acts separately on each unstable mode

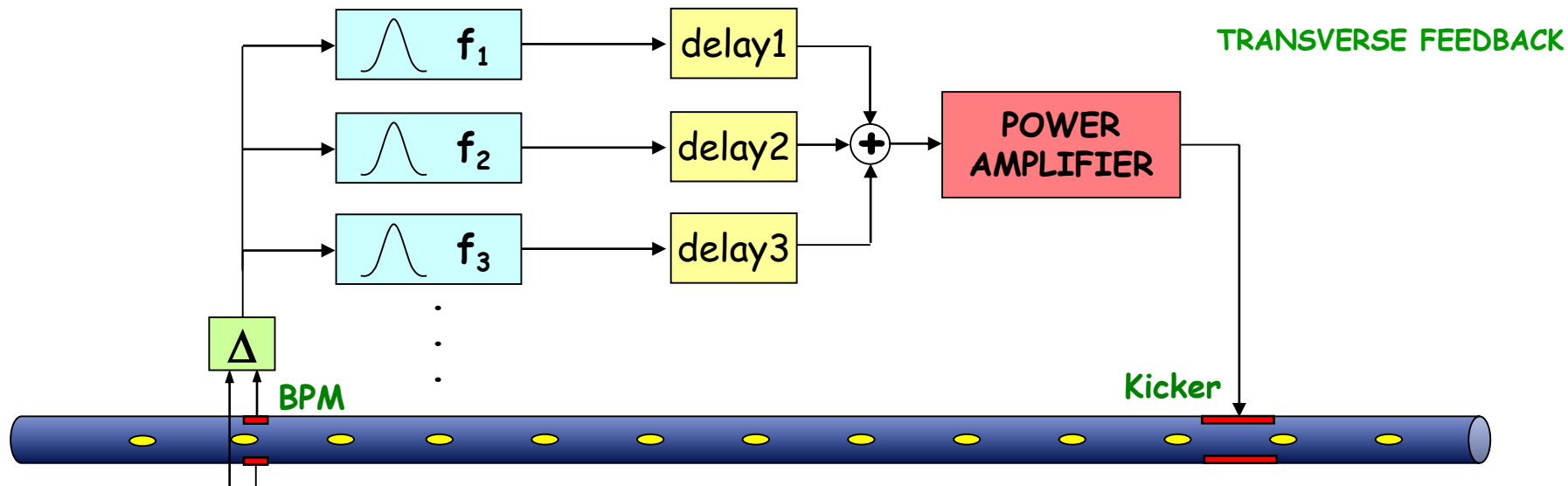

An analog electronics generates the position error signal from the BPM buttons

A number of processing channels working in parallel each dedicated to one of the controlled modes

The signals are band-pass filtered, phase shifted by an adjustable delay line to produce a negative feedback and recombined

A **bunch-by-bunch** (time domain) feedback individually steers each bunch by applying small electromagnetic kicks every time the bunch passes through the kicker: the result is a damped oscillation lasting several turns

The correction signal for a given bunch is generated based on the motion of the same bunch

Example of implementation using a time division scheme

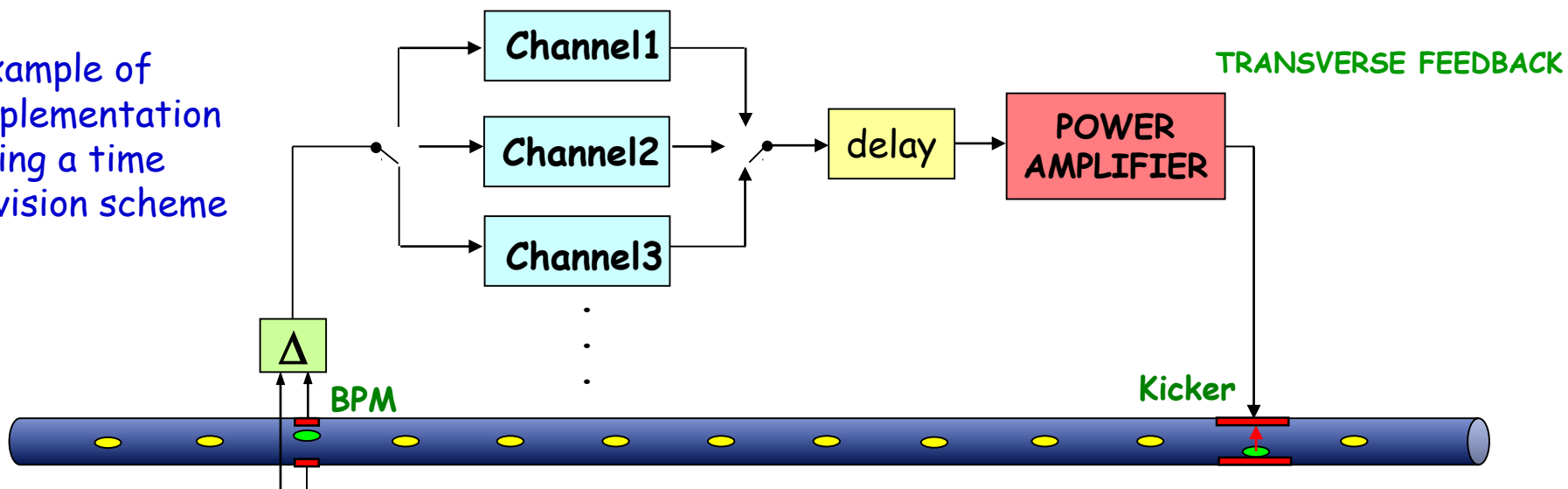

Every bunch is measured and corrected at every machine turn but, due to the delay of the feedback chain, the correction kick corresponding to a given measurement is applied to the bunch **one or more turns later**

Damping the oscillation of each bunch is equivalent to damping all multi-bunch modes

Transverse feedback

The correction signal applied to a given bunch must be **proportional to the derivative of the bunch oscillation** at the kicker, thus it must be a sampled sinusoid shifted $\pi/2$ with respect to the oscillation of the bunch when it passes through the kicker

The signal from a BPM with the **appropriate betatron phase advance** with respect to the kicker can be used to generate the correction signal

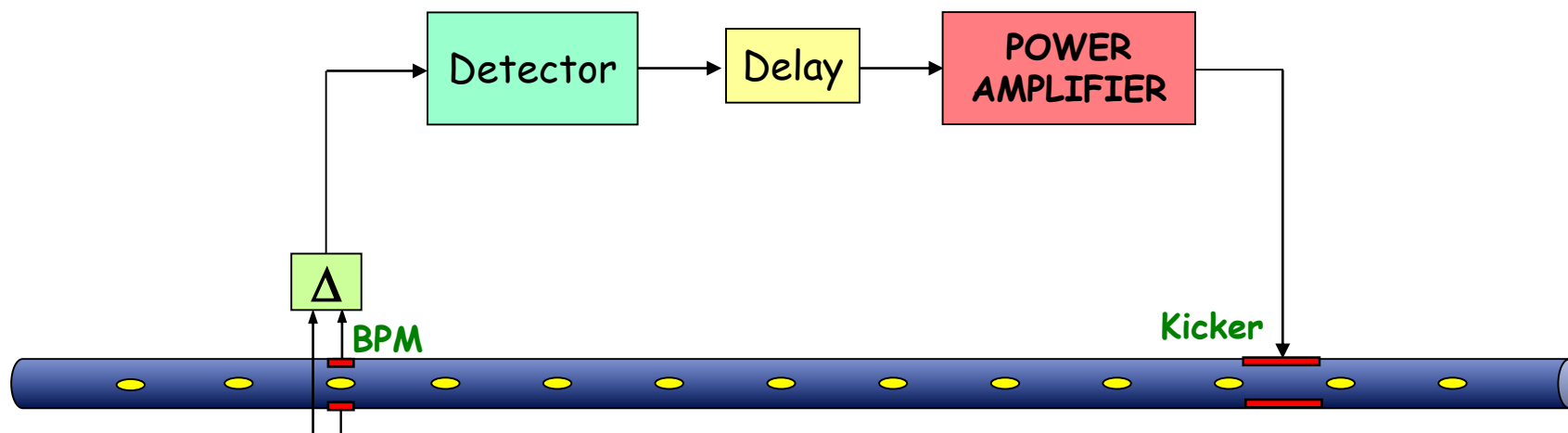

The **detector** down converts the high frequency (typically a multiple of the bunch frequency f_{rf}) BPM signal into base-band (range $0 - f_{rf}/2$)

The **delay line** assures that the signal of a given bunch passing through the feedback chain arrives at the kicker when, after one machine turn, the same bunch passes through it

Transverse feedback case

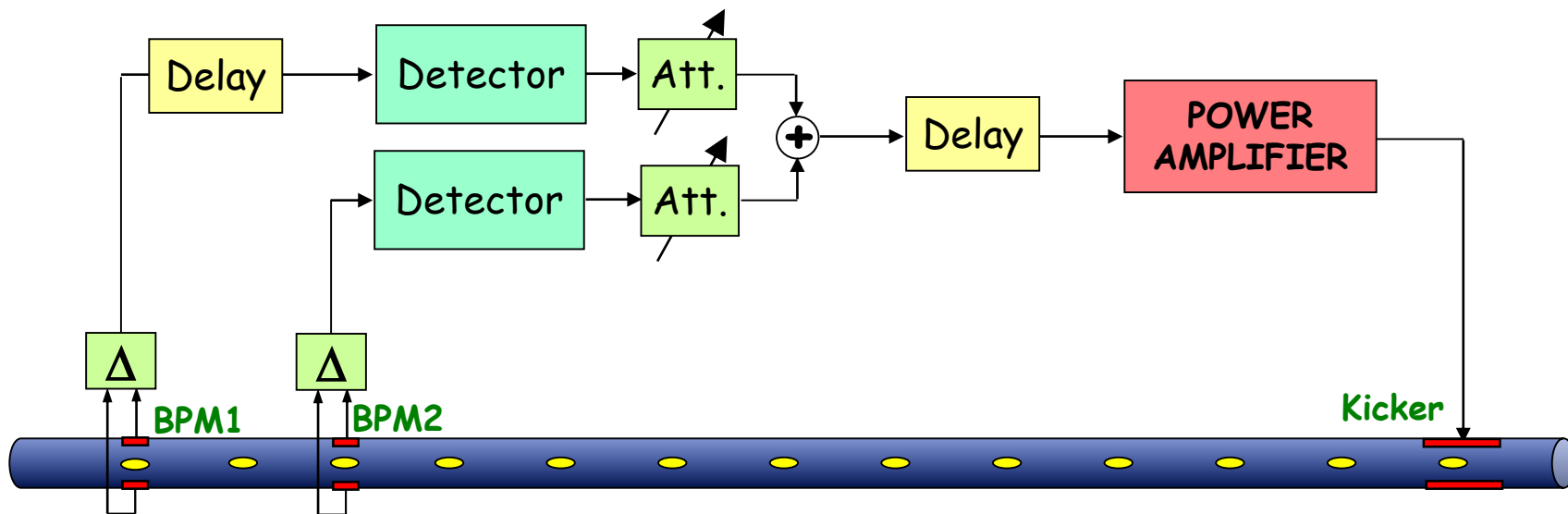

The **two BPMs** can be placed in any ring position with respect to the kicker providing that they are **separated by $\pi/2$ in betatron phase**

Their signals are combined with variable attenuators in order to provide the required phase of the resulting signal

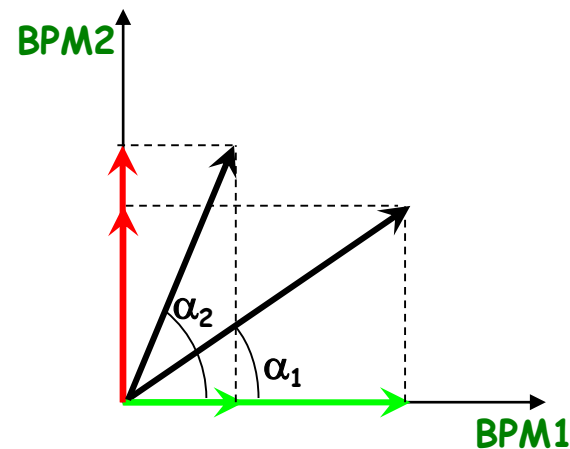

Transverse feedback case

The revolution harmonics (frequency components at multiples of ω_0) are useless components that have to be eliminated in order not to saturate the RF amplifier

This operation is also called "stable beam rejection"

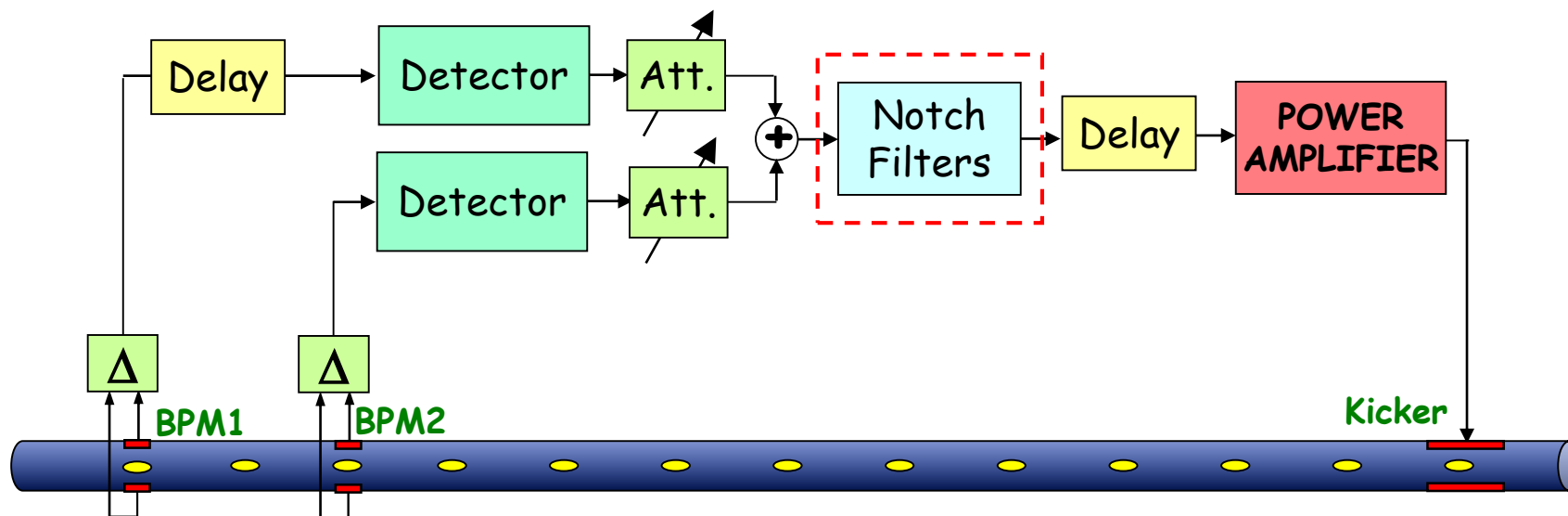

Similar feedback architectures have been used to build the transverse multi-bunch feedback system of a number of light sources: ex. ALS, BessyII, PLS, ANKA, ...

Transverse and longitudinal case

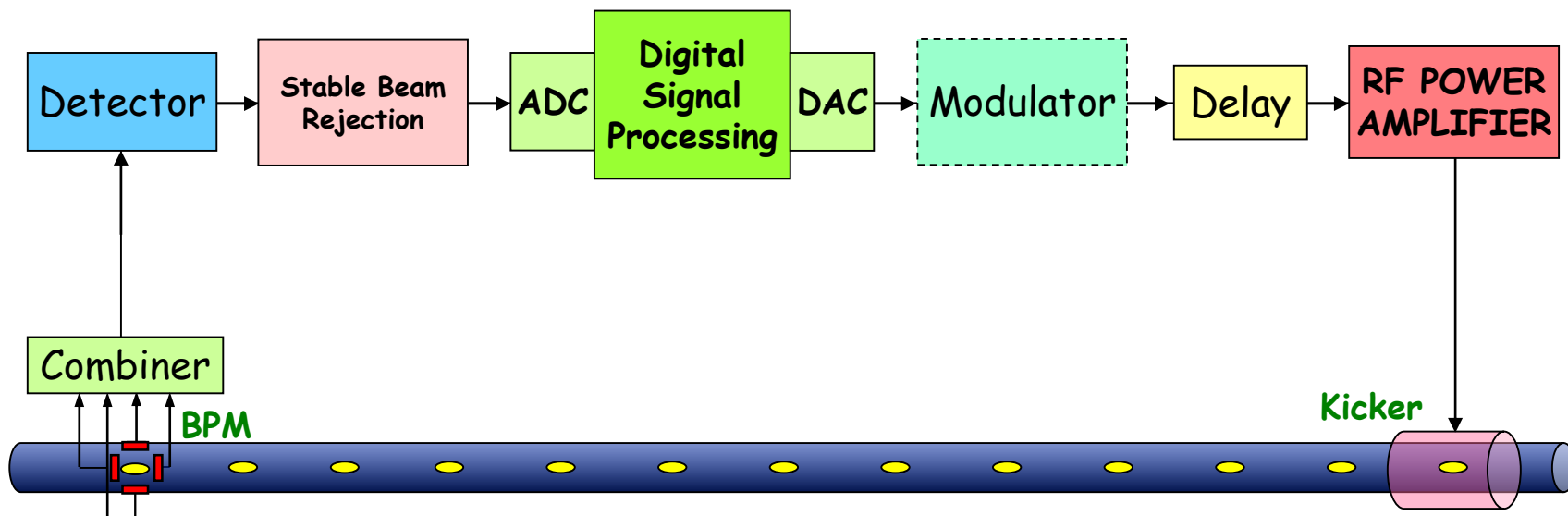

The **combiner** generates the X , Y or Σ signal from the BPM button signals

The **detector** (RF front-end) demodulates the position signal to base-band

"Stable beam components" are suppressed by the **stable beam rejection module**

The resulting signal is digitized, processed and re-converted to analog by the **digital processor**

The **modulator** translates the correction signal to the kicker working frequency (long. only)

The **delay line** adjusts the timing of the signal to match the bunch arrival time

The **RF power amplifier** supplies the power to the **kicker**

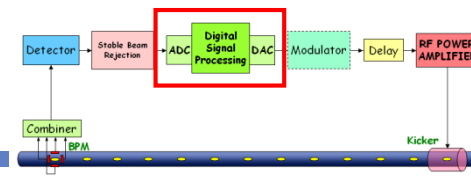

ADVANTAGES OF DIGITAL FEEDBACKS

- ↘ **reproducibility**: all parameters (gains, delays, filter coefficients) are NOT subject to temperature/environment changes or aging
- ↘ **programmability**: the implementation of processing functionalities is usually made using DSPs or FPGAs, which are programmable via software/firmware
- ↘ **performance**: digital controllers feature superior processing capabilities with the possibility to implement sophisticated control algorithms not feasible in analog
- ↘ **additional features**: possibility to combine basic control algorithms and additional useful features like signal conditioning, saturation control, down sampling, etc.
- ↘ **implementation of diagnostic tools**, used for both feedback commissioning and machine physics studies
- ↘ **easier and more efficient integration** of the feedback in the accelerator control system for data acquisition, feedback setup and tuning, automated operations, etc.

DISADVANTAGE OF DIGITAL FEEDBACKS

- ↘ **High delay** due to ADC, digital processing and DAC

Rejection of stable beam signal

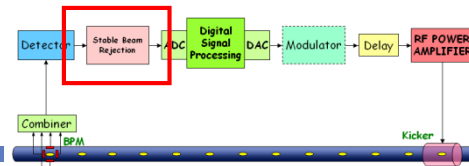

The turn-by-turn pulses of each bunch can have a constant offset (stable beam signal) due to:

- ↘ **transverse case**: off-centre beam or unbalanced BPM electrodes or cables
- ↘ **longitudinal case**: beam loading, i.e. different synchronous phase for each bunch

In the frequency domain, the stable beam signal carries non-zero revolution harmonics

These components have to be suppressed because don't contain information about multi-bunch modes and can saturate ADC, DAC and amplifier

Examples of used techniques:

Balancing of BPM buttons: variable attenuators on the electrodes to equalize the amplitude of the signals (transverse feedback)

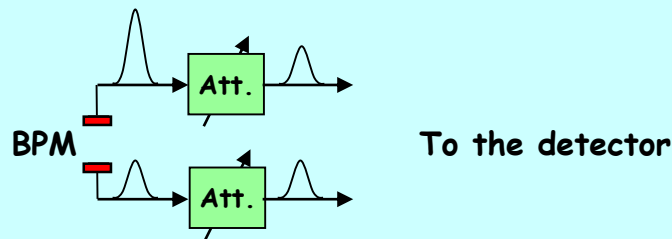

Comb filter using delay lines and combiners: the frequency response is a series of notches at multiple of ω_0 , DC included

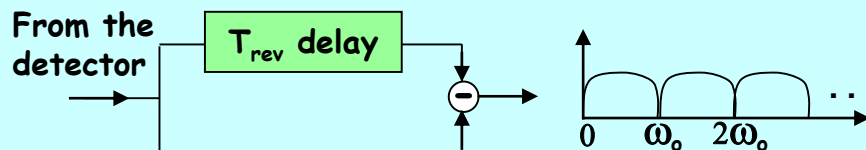

Digital DC rejection: the signal is sampled at f_{rf} , the turn-by-turn signal is integrated for each bunch, recombined with the other bunches, converted to analog and subtracted from the original signal

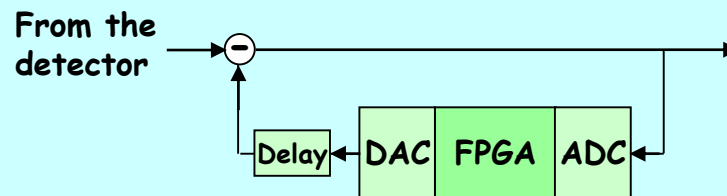

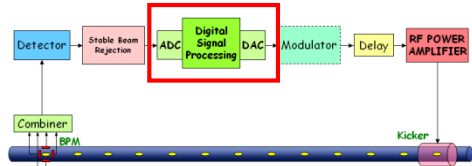

The **A/D converter** samples and digitizes the signal at the bunch repetition frequency: each sample corresponds to the position (X , Y or Φ) of a given bunch. Precise synchronization of the sampling clock with the bunch signal must be provided

The **digital samples** are then **de-multiplexed** into M channels (M is the number of bunches): in each channel the turn-by-turn samples of a given bunch are processed by a dedicated **digital filter** to calculate the correction samples

The basic processing consists in **DC component suppression** (if not completely done by the external stable beam rejection) and **phase shift** at the betatron/synchrotron frequency

After processing, the correction sample streams are **recombined** and eventually converted to analog by the **D/A converter**

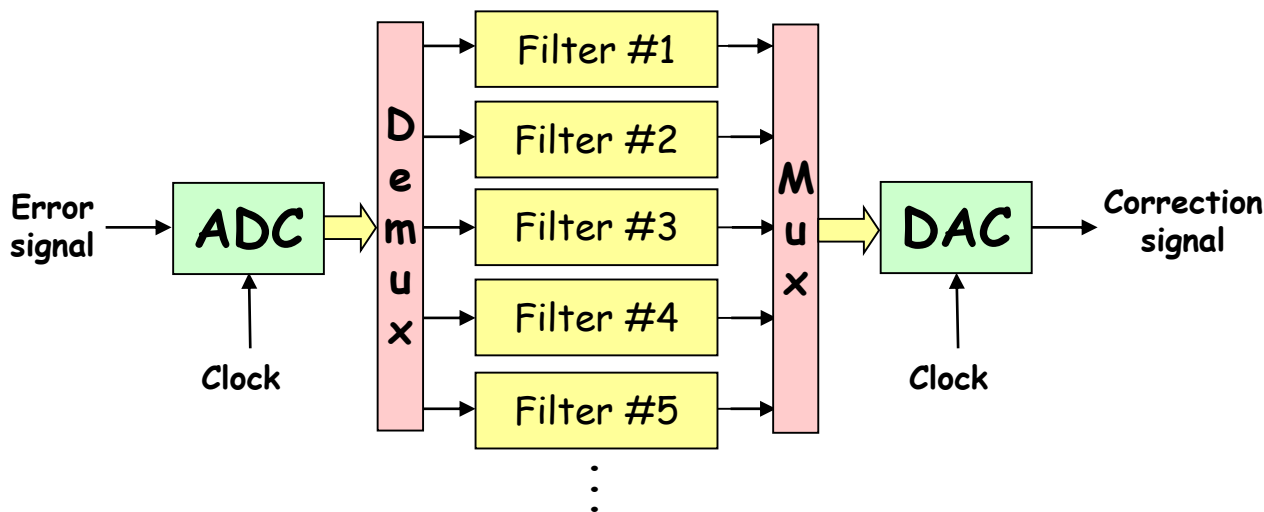

Amplifier and kicker

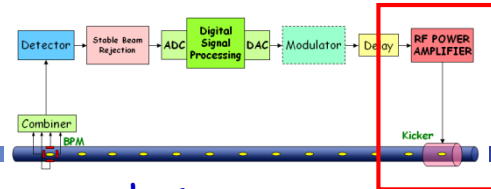

The **kicker** is the **feedback actuator**. It generates a transverse/longitudinal electromagnetic field that steers the bunches with small kicks as they pass through the kicker. The overall effect is damping of the betatron/synchrotron oscillations

The **amplifier** must provide the necessary RF power to the kicker by amplifying the signal from the DAC (or from the modulator in the case of longitudinal feedbacks)

A **bandwidth** of at least $f_{rf}/2$ is necessary: from $\sim DC$ (all kicks of the same sign) to $\sim f_{rf}/2$ (kicks of alternating signs)

The bandwidth of amplifier-kicker must be sufficient to correct each bunch with the appropriate kick without affecting the neighbour bunches. The amplifier-kicker design has to maximize the kick strength while minimizing the cross-talk between corrections given to adjacent bunches

Important issue: the group delay of the amplifier must be as constant as possible, i.e. the phase response must be linear, otherwise the feedback efficiency is reduced for some modes and the feedback can even become positive

Shunt impedance, ratio between the squared voltage seen by the bunch and twice the power at the kicker input:

$$R = \frac{V^2}{2P_{IN}}$$

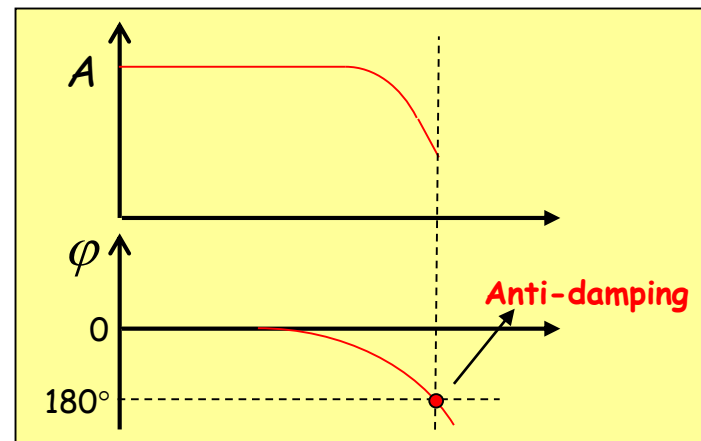

Kicker and Amplifier: transverse FB

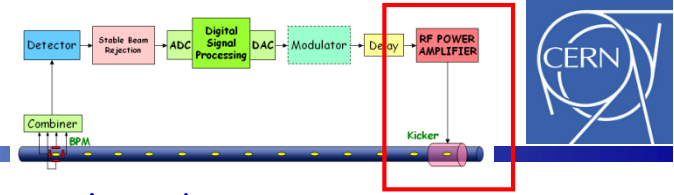

For the transverse kicker a **stripline** geometry is usually employed
 Amplifier and kicker work in the $\sim DC - \sim f_{rf}/2$ frequency range

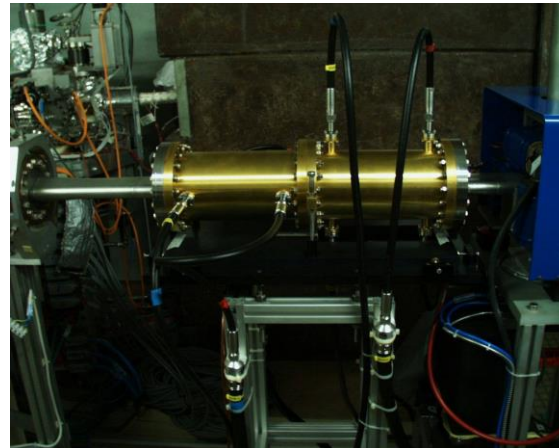
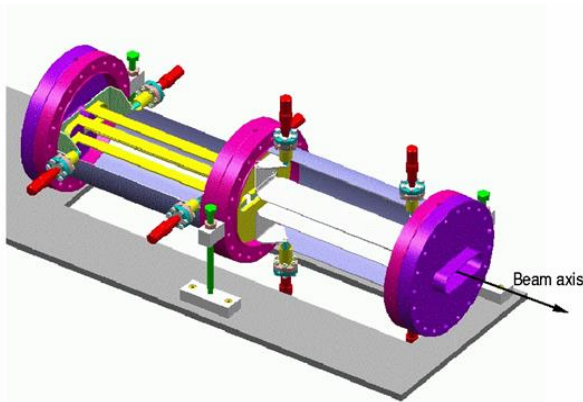
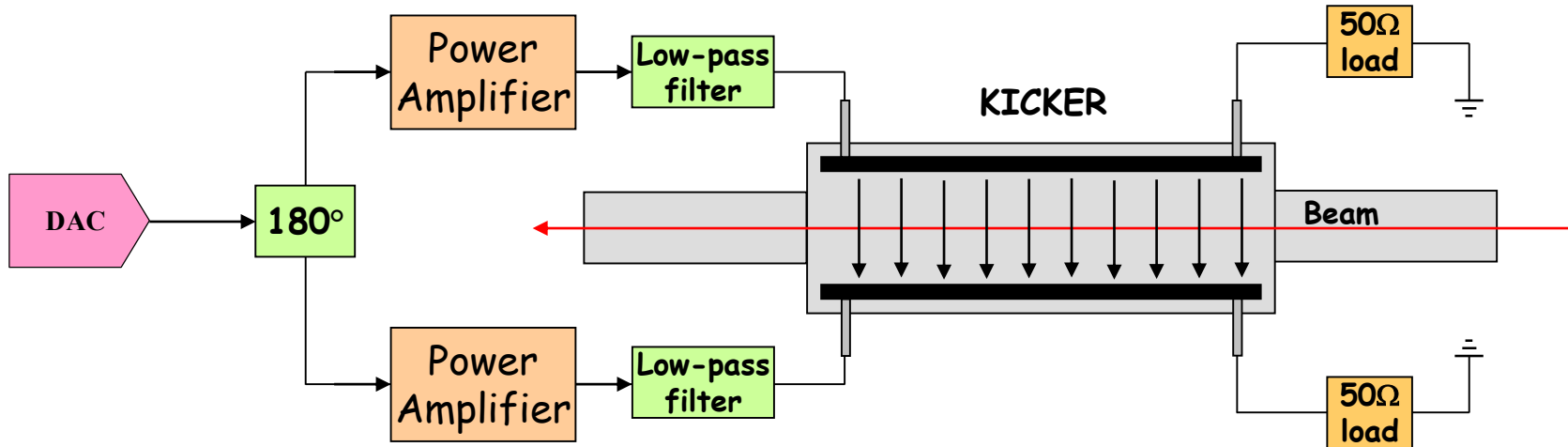

The ELETTRA/SLS transverse kicker (by Micha Dehler-PSI)

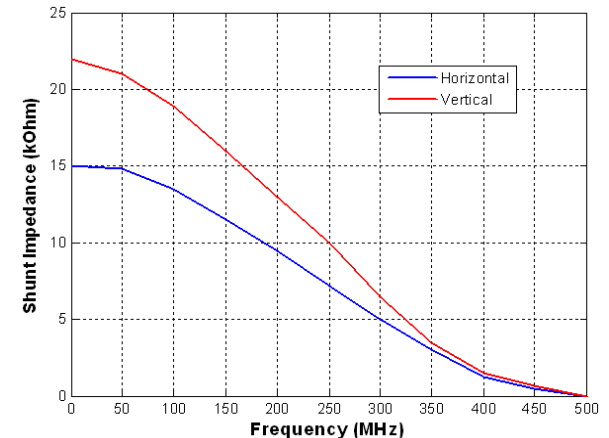

Shunt impedance of the ELETTRA/SLS transverse kickers

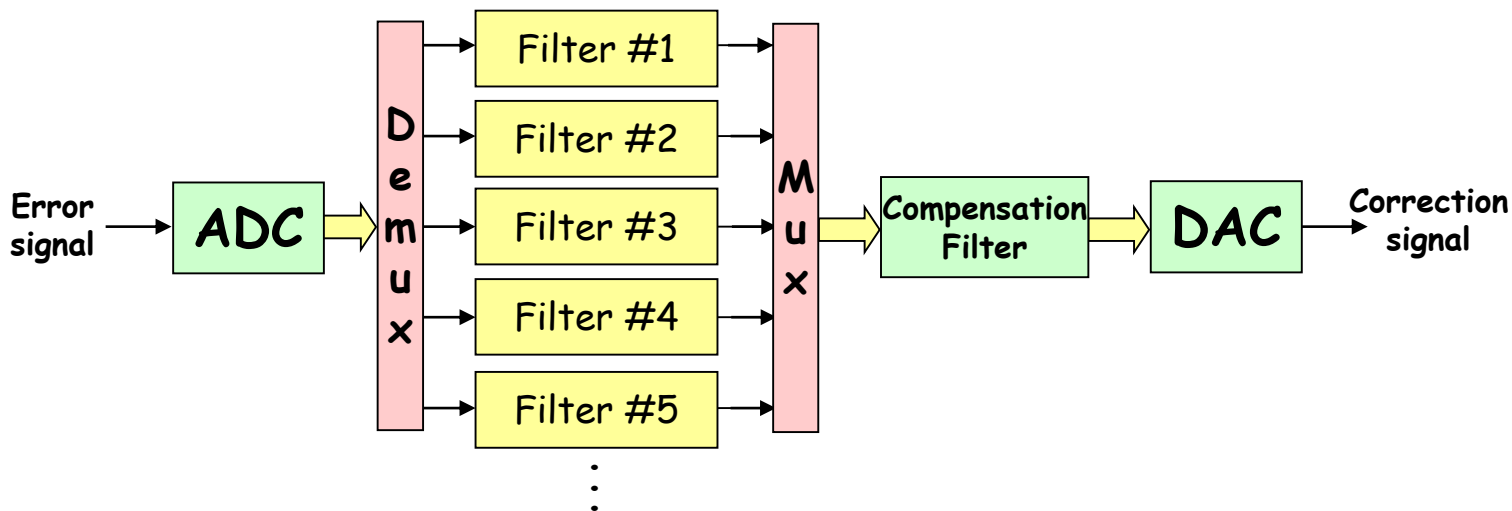

M channel/filters each dedicated to one bunch: M is the number of bunches

To damp the bunch oscillations the **turn-by-turn kick signal** must be the **derivative** of the bunch position at the kicker: for a given oscillation frequency a $\pi/2$ **phase shifted** signal must be generated

In determining the real phase shift to perform in each channel, the phase advance between BPM and kicker must be taken into account as well as any additional delay due to the feedback latency (multiple of one machine revolution period)

The digital processing must also **reject** any residual **constant offset** (stable beam component) from the bunch signal to avoid DAC saturation

Digital filters can be implemented with **FIR** (Finite Impulse Response) or **IIR** (Infinite Impulse Response) structures. Various techniques are used in the design: ex. frequency domain design and model based design

A filter on the full-rate data stream can compensate for amplifier/kicker not-ideal behaviour

The minimum requirements are:

1. DC rejection (coefficients sum = 0)
2. Given amplitude response at the tune frequency
3. Given phase response at the tune frequency

A 3-tap FIR filter can fulfil these requirements: the filter coefficients can be calculated analytically

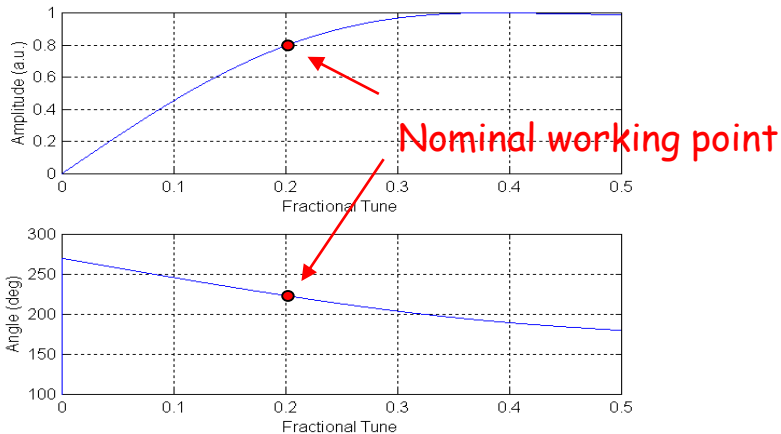

Example:

- Tune $\omega / 2\pi = 0.2$
- Amplitude response at tune $|H(\omega)| = 0.8$
- Phase response at tune $\alpha = 222^\circ$

$$H(z) = -0.63 + 0.49 z^{-1} + 0.14 z^{-2}$$

Z transform of the FIR filter response

In order to have zero amplitude at DC, we must put a "zero" in $z=1$. Another zero in $z=c$ is added to fulfill the phase requirements.

c can be calculated analytically:

$$H(z) = k(1 - z^{-1})(1 - cz^{-1})$$

$$H(z) = k(1 - (1+c)z^{-1} + cz^{-2}) \quad z = e^{j\omega}$$

$$H(\omega) = k(1 - (1+c)e^{-j\omega} + ce^{-2j\omega})$$

$$e^{-j\omega} = \cos \omega - j \sin \omega, \quad \alpha = \text{ang}(H(\omega))$$

$$\text{tg}(\alpha) = \frac{c(\sin(\omega) - \sin(2\omega)) + \sin(\omega)}{c(\cos(2\omega) - \cos(\omega)) + 1 - \cos(\omega)}$$

$$c = \frac{\text{tg}(\alpha)(1 - \cos(\omega)) - \sin(\omega)}{(\sin(\omega) - \sin(2\omega)) - \text{tg}(\alpha)(\cos(2\omega) - \cos(\omega))}$$

k is determined given the required amplitude response at tune $|H(\omega)|$:

$$k = \frac{|H(\omega)|}{\sqrt{(1 - (1+c)\cos(\omega) + c\cos(2\omega))^2 + ((1+c)\sin(\omega) - c\sin(2\omega))^2}}$$

- Digital processing imposes a transition delay longer than the revolution time of normal size synchrotrons (few μ s).
- Feedback acts N (a few) turns later
 - Particles advance $N \cdot Q$ in phase between measurement and kick
 - Correction signal needs tune dependent phase shifter

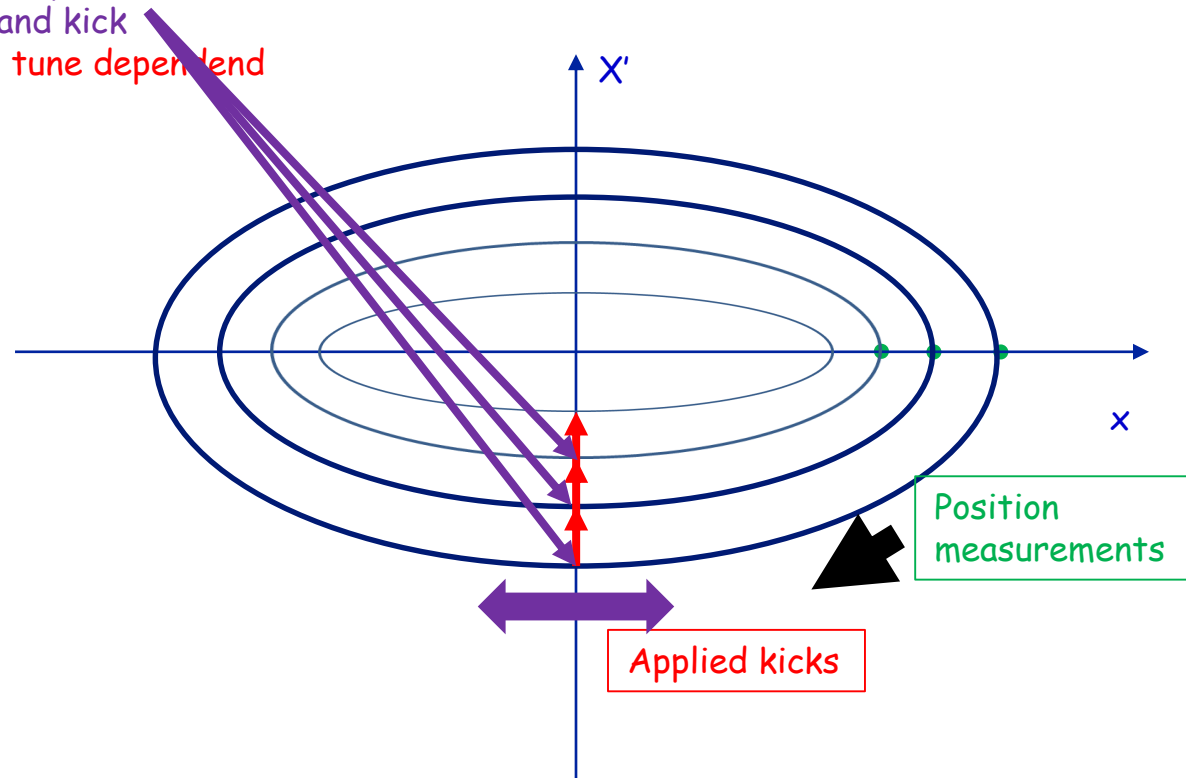



Filter Designers **Quick Specification** **Advanced Specs** **Multirate** **Add** **Layout Tools**

Frequency Sampling Equiripple Low Pass High Pass Band Pass Band Stop Blank Specification Differentiator Hilbert Transformer Polyphase Control Point Image Overlay Guide

Cursor **Tree**

Magnitude: -0.4600
 Frequency: 0.006
 Phase: -166.2°
 Delay: -3.1
 Z-Plane

Frequency Domain

Response: -0.4600
 Time: 0.4

Time Domain

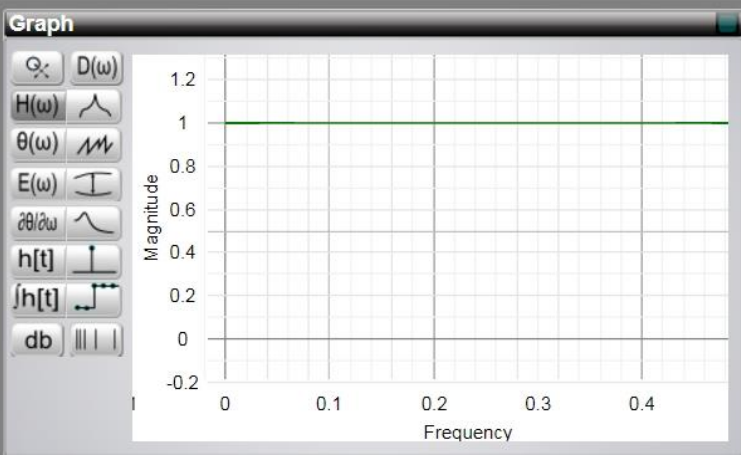
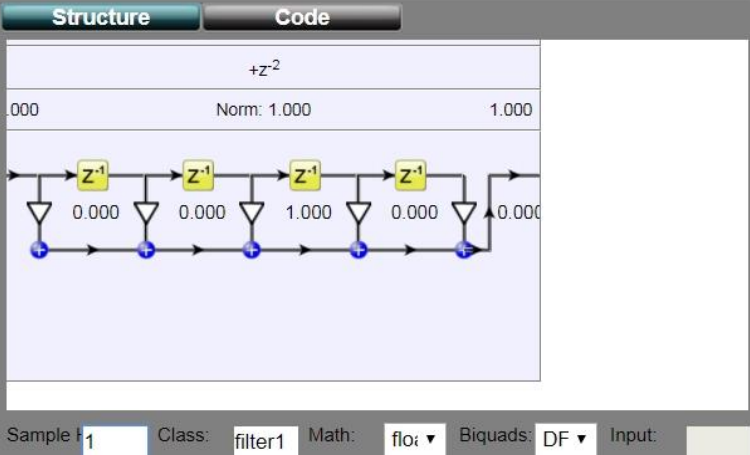
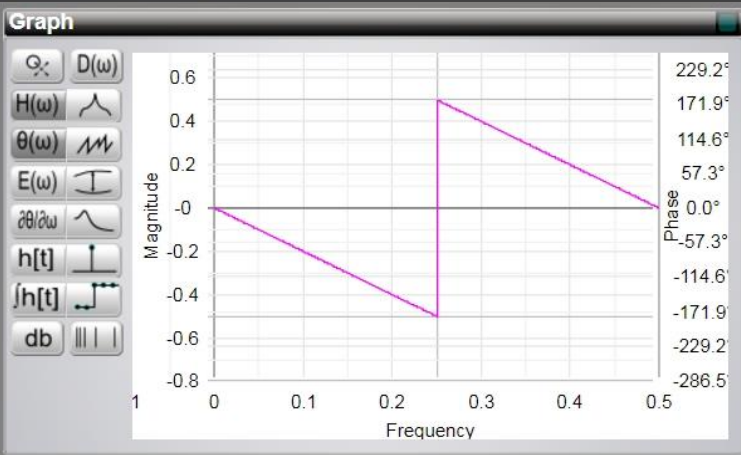
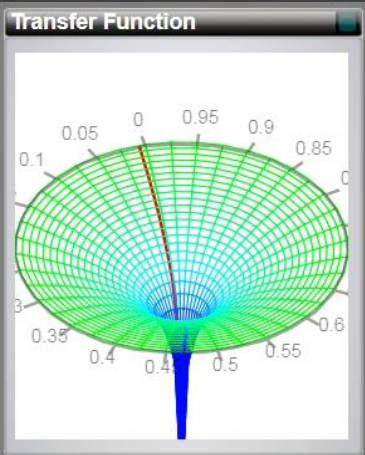
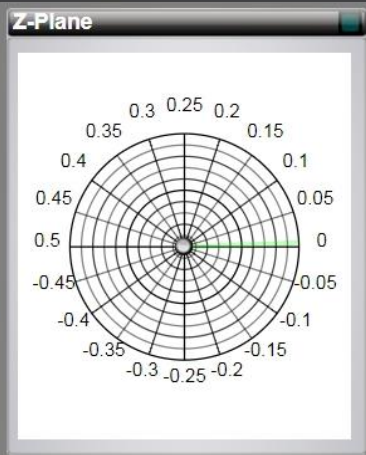

With more degrees of freedom additional features can be added to a FIR filter

Ex.: *transverse feedback*. The **tune frequency** of the accelerator can significantly **change** during machine operations. The filter response must guarantee the same feedback efficiency in a given frequency range by performing **automatic compensation** of phase changes.

In this example the feedback delay is four machine turns. When the tune frequency increases, the phase of the filter must increase as well, i.e. the **phase response** must have a **positive slope** around the working point.

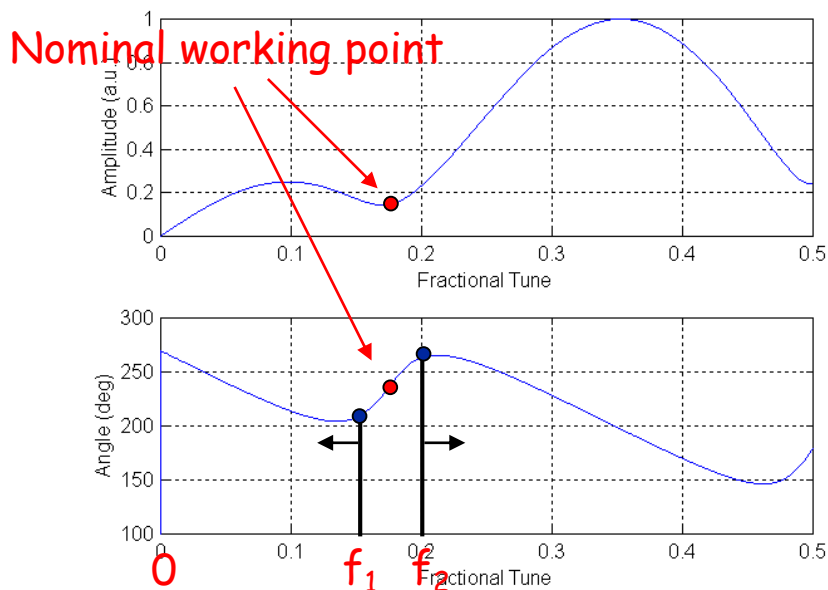

The filter design can be made using the Matlab function *invfreqz()*

This function calculates the filter coefficients that best fit the required frequency response using the **least squares method**

The desired response is specified by defining amplitude and phase at three different frequencies: 0 , f_1 and f_2

A filter often employed in longitudinal feedback systems is a selective FIR filter which impulse response (the filter coefficients) is a **sampled sinusoid** with frequency equal to the synchrotron tune

The filter amplitude response has a maximum at the tune frequency and linear phase

The more filter coefficients we use the more selective is the filter

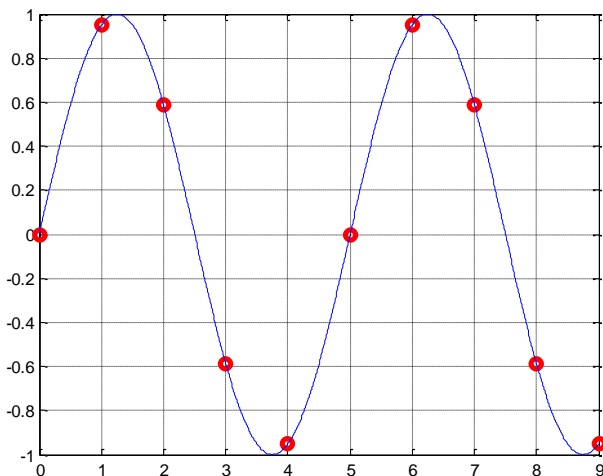

Samples of the filter impulse response
(= filter coefficients)

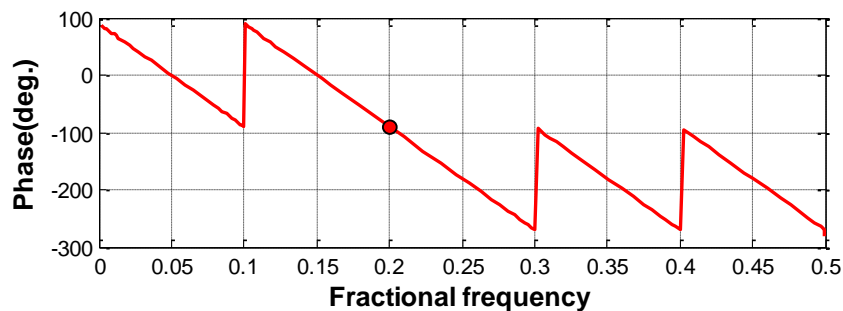
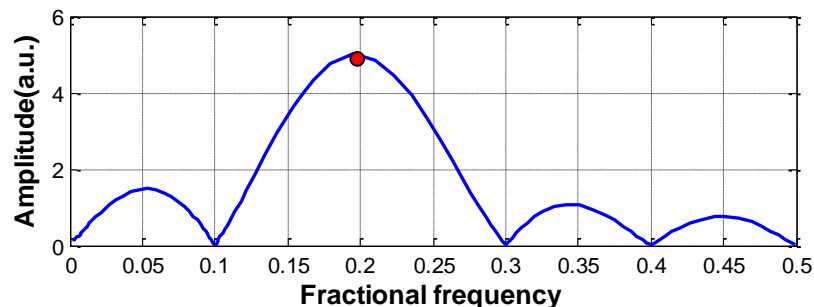

Amplitude and phase response of the filter

A feedback system can implement a number of diagnostic tools useful for commissioning and optimization of the feedback system as well as for machine physics studies:

1. **ADC data recording:** acquisition and recording, in parallel with the feedback operation, of a large number of samples for off-line data analysis
2. **Modification of filter parameters on the fly** with the required timing and even individually for each bunch: switching ON/OFF the feedback, generation of grow/damp transients, optimization of feedback performance, ...
3. **Injection of externally generated digital samples:** for the excitation of single/multi bunches

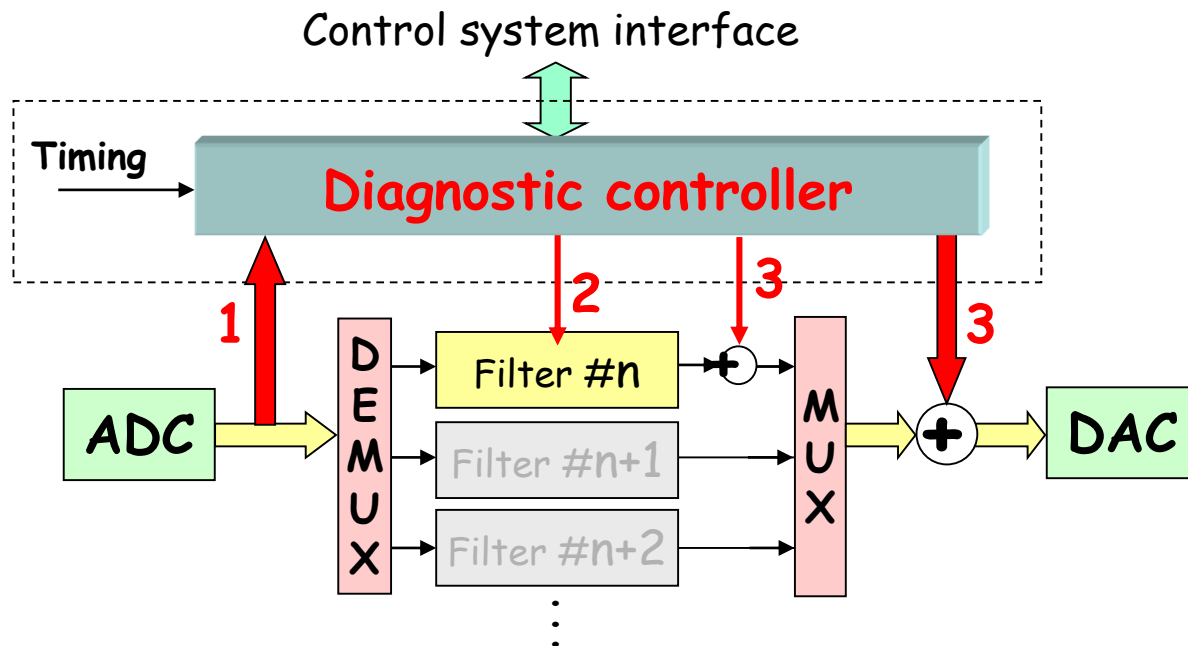

The feedback loop is switched off for one or more selected bunches and the excitation is injected in place of the correction signal. Excitations can be:

- white (or pink) noise
- sinusoids

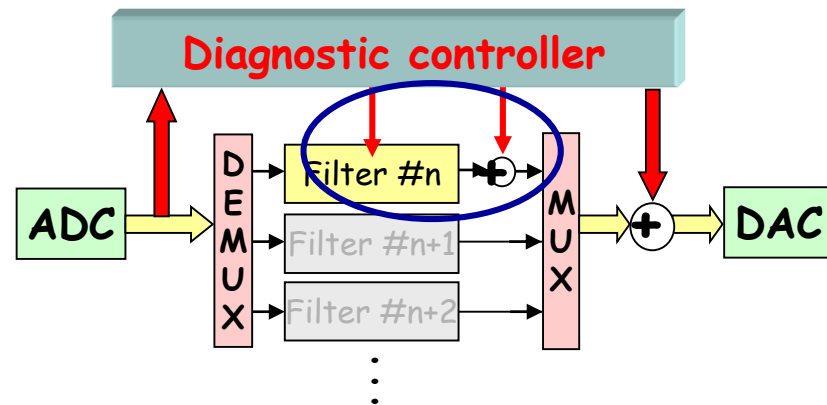
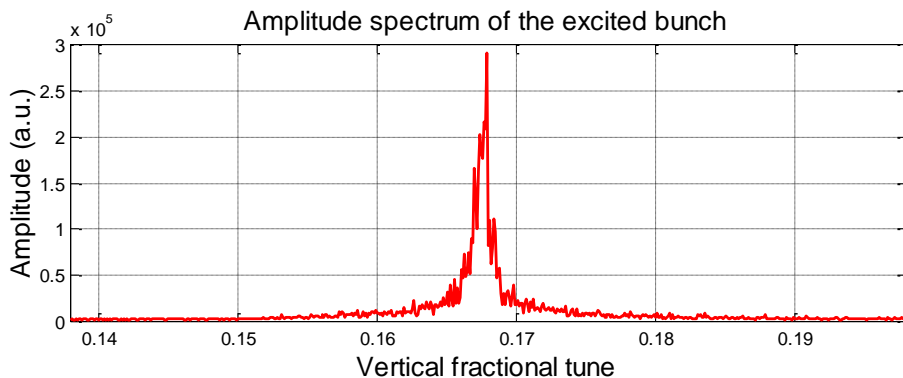
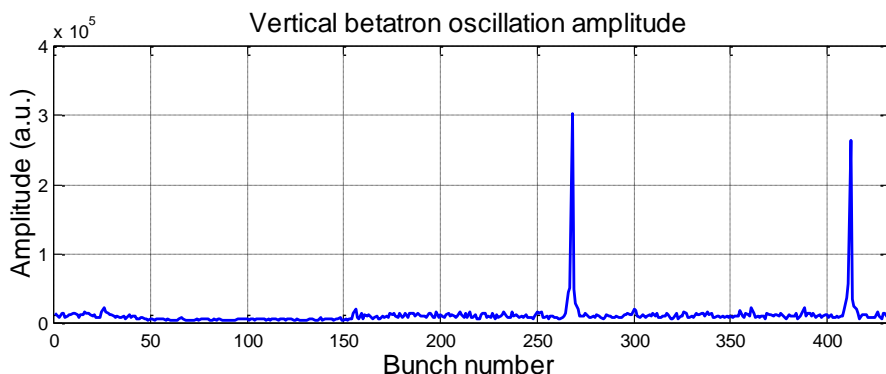

In this example two bunches are vertically excited with pink noise in a range of frequencies centered around the tune, while the feedback is applied on the other bunches. The spectrum of one excited bunch reveals a peak at the tune frequency

This technique is used to measure the betatron tune with almost no deterioration of the beam quality

Interesting measurements can be performed by adding pre-defined signals in the output of the digital processor

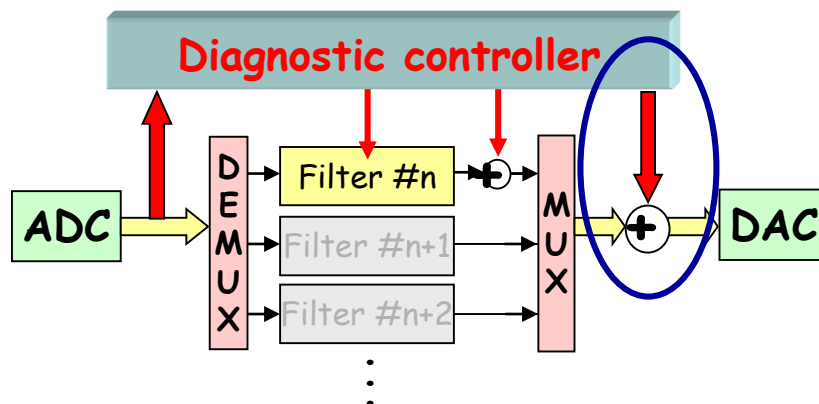

1. By injecting a sinusoid at a given frequency, the corresponding beam multi-bunch mode can be excited to test the performance of the feedback in damping that mode
2. By injecting an appropriate signal and recording the ADC data with filter coefficients set to zero, the beam transfer function can be calculated
3. By injecting an appropriate signal and recording the ADC data with filter coefficients set to the nominal values, the closed loop transfer function can be determined

A powerful diagnostic application is the **generation of transients**. Transients can be generated by **changing the filter coefficients** accordingly to a predefined timing and by concurrently recording the oscillations of the bunches

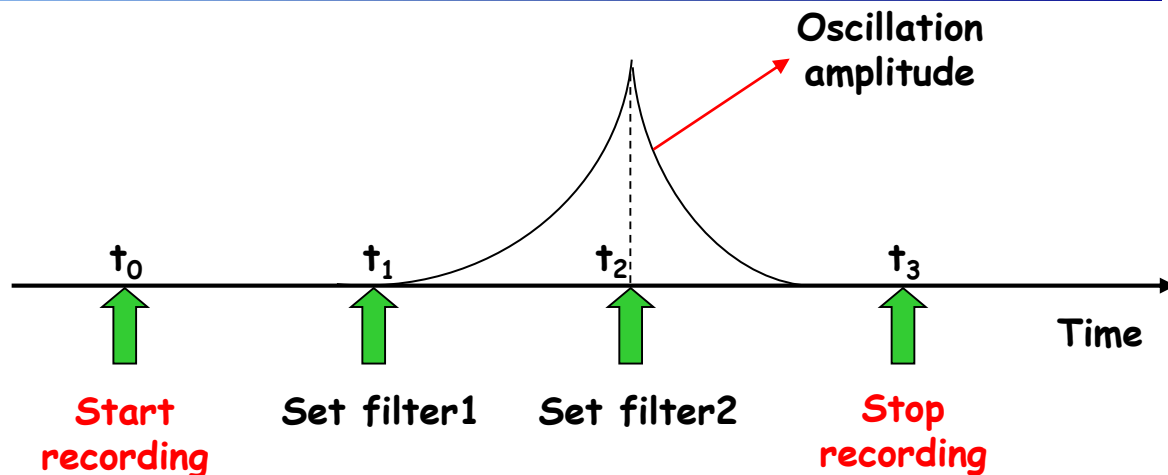

Different types of transients can be generated, **damping times and growth rates** can be calculated by exponential fitting of the transients:

1. **Constant multi-bunch oscillation** → **FB on**: damping transient
2. **FB on** → **FB off** → **FB on**: grow/damp transient
3. **Stable beam** → **positive FB on (anti-damping)** → **FB off**: natural damping transient

.....

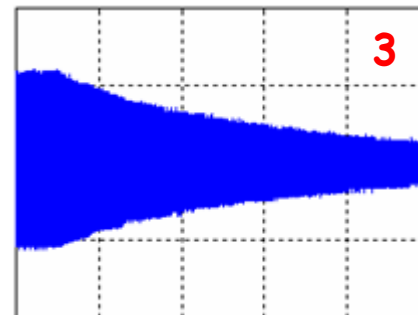
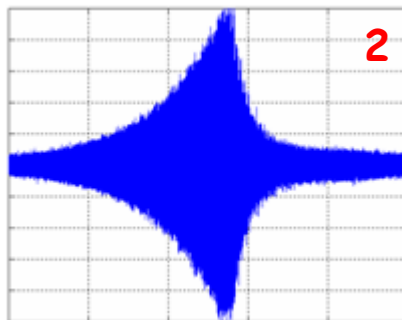
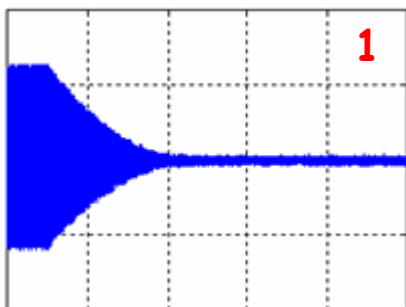

.....

Grow/damp transients can be analyzed by means of 3-D graphs

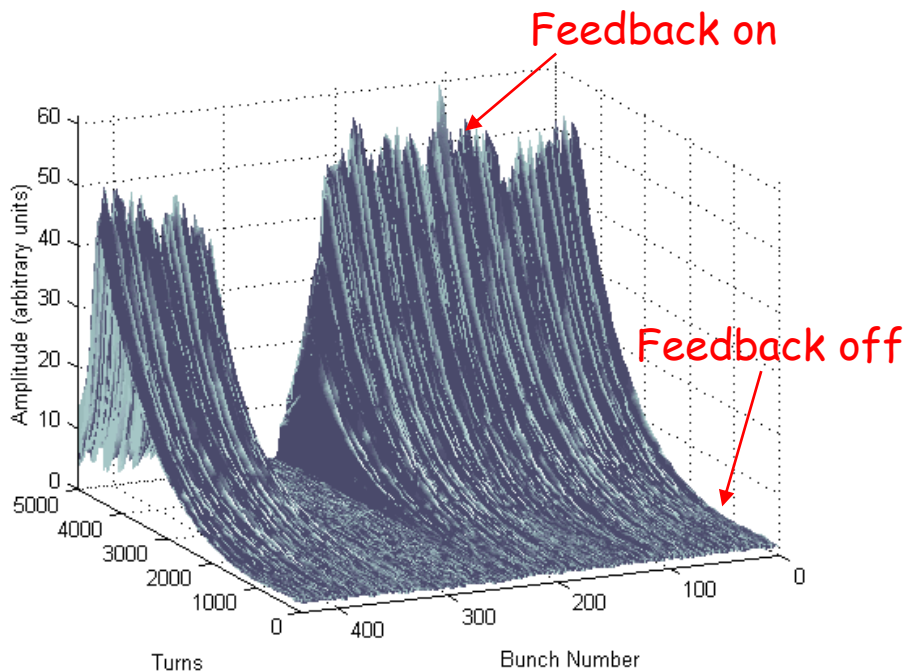

Evolution of the bunches oscillation amplitude during a grow-damp transient

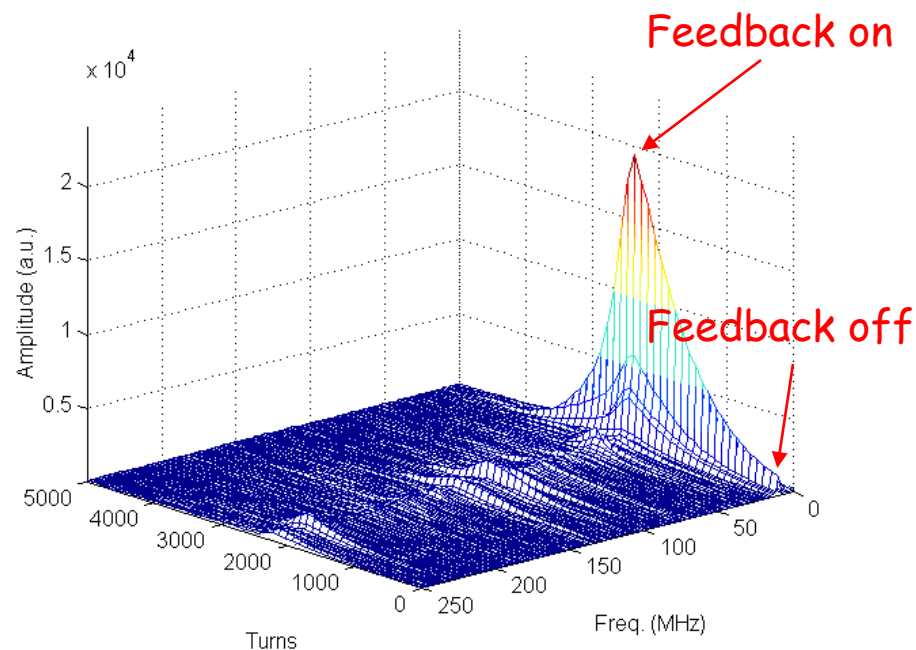

Evolution of coupled-bunch unstable modes during a grow-damp transient

Vertical modes

Revolution harmonics

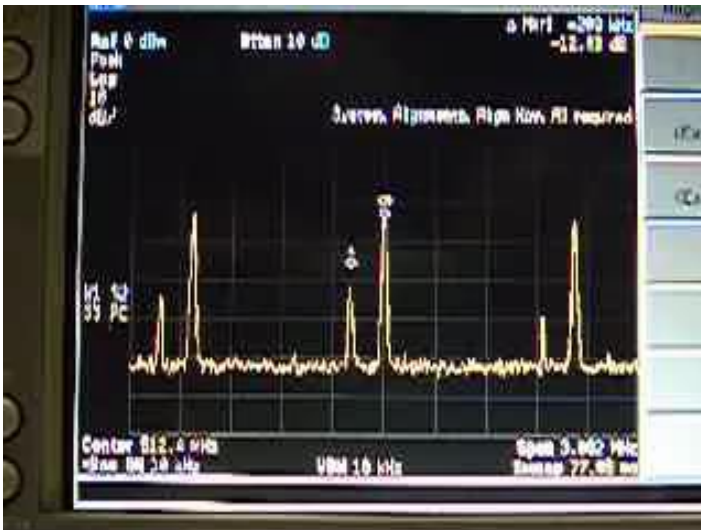
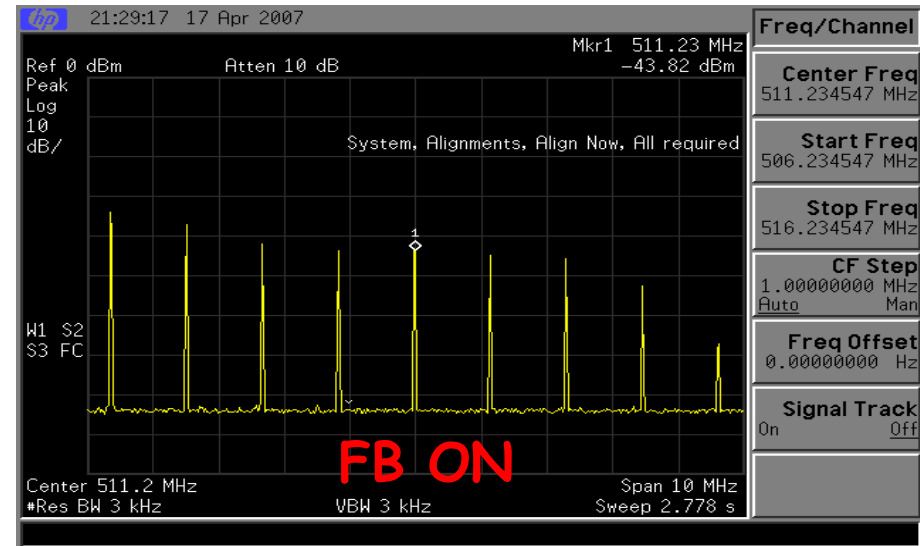
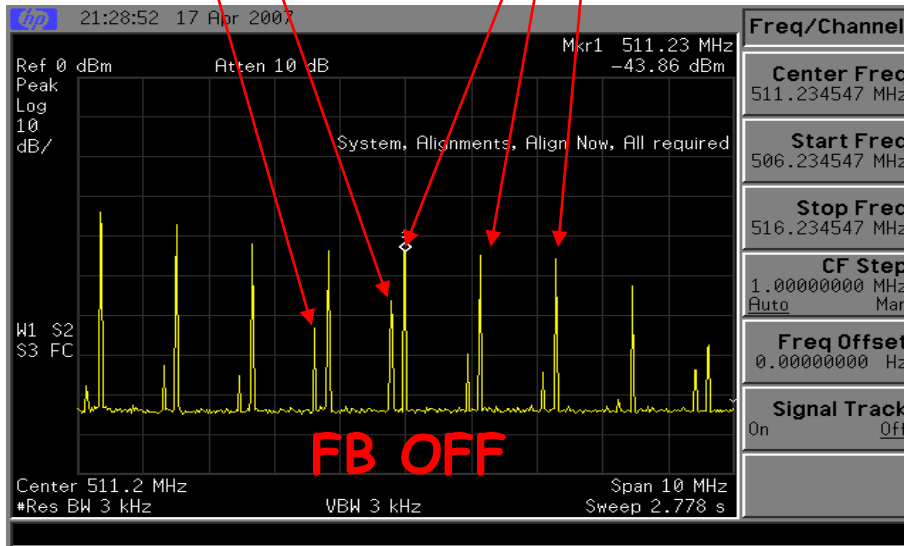

Spectrum analyzer connected to a stripline pickup: observation of vertical instabilities. The sidebands corresponding to vertical coupled-bunch modes disappear as soon as the transverse feedback is activated

- Under certain circumstances even single bunches are unstable in an accelerator:
 - wakes of the head of the beam interacting with the tail
 - TMCI: transverse mode coupling instability (later this course)
 - micro bunching
 - ...
- Can be damped with an active feedback
 - depending on bunchlength very high demands on system bandwidth

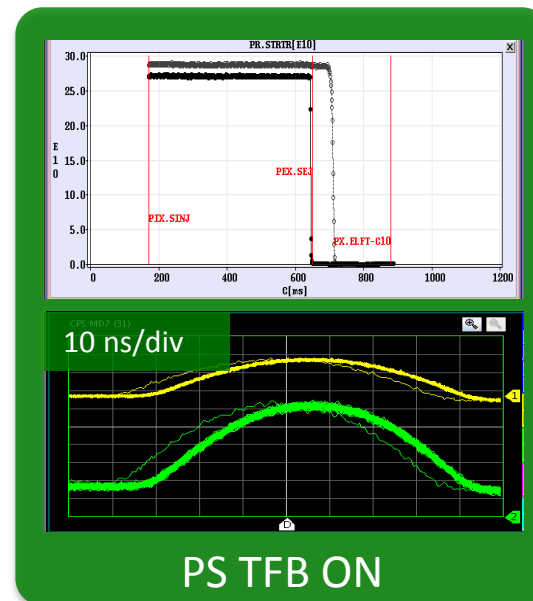
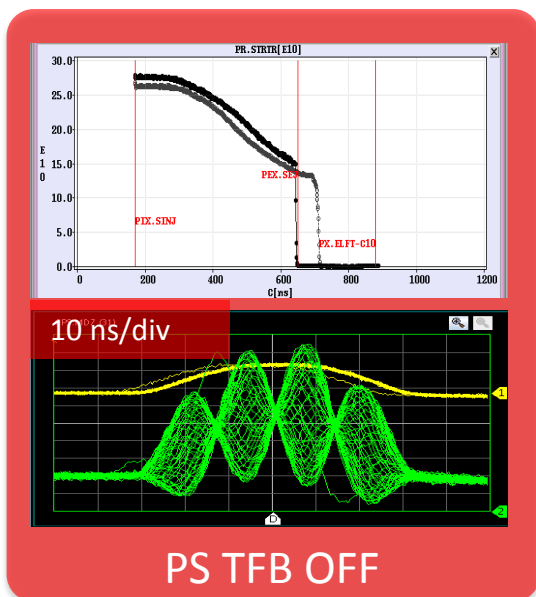

Single high intensity proton bunch, TMCI unstable

Feedback OFF

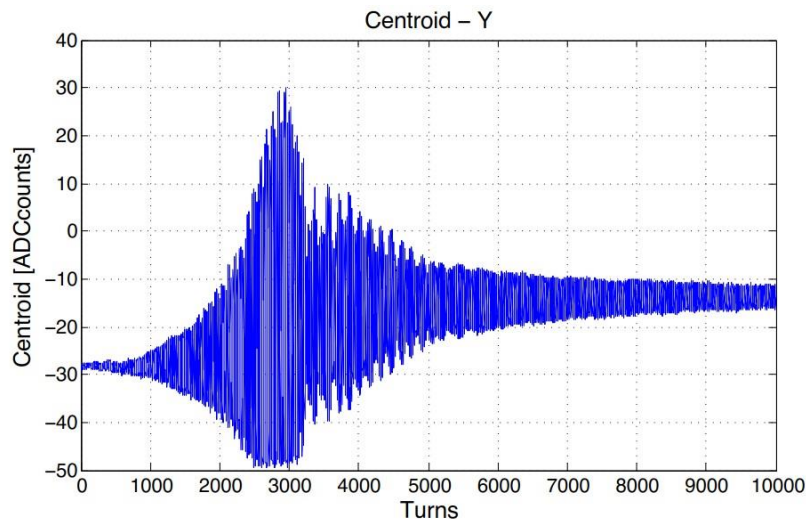

Figure 3: Open-Loop (no feedback) time-domain recording of bunch motion, Q26 lattice, vertical centroid via bunch samples. Unstable bunch motion grows from injection, with charge loss, then stability at roughly turn 3000.

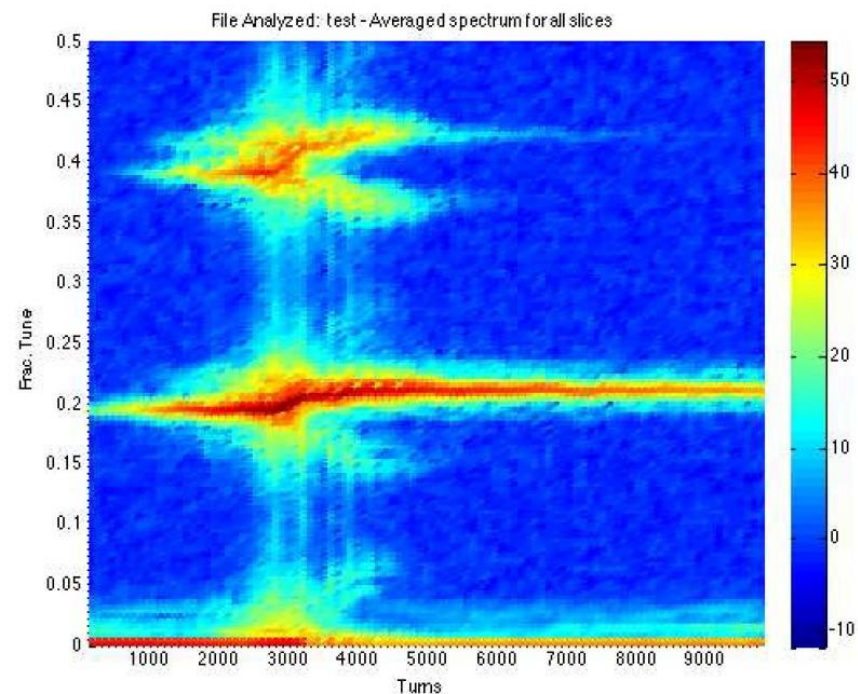

Figure 4: Open-Loop (no feedback) spectrogram of same transient as Figure 3. The beam is TMCI unstable in these conditions, $\nu_y = 0.185$ $\nu_s = 0.006$. Unstable modes 1 and 2 begin at turn 2000 and with charge loss end at turn 4500. Significant intensity-dependent tune shifts are seen as charge is lost in the transient.

Feedback "ON"

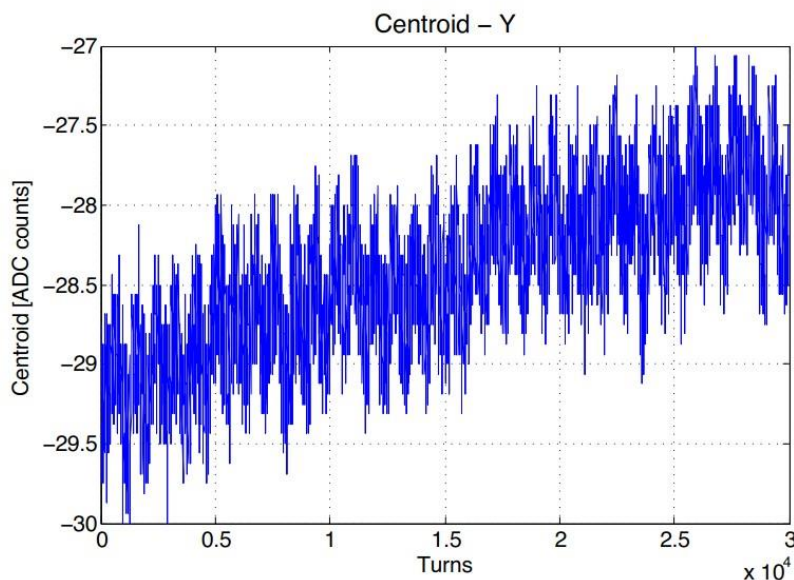

Figure 5: Closed -Loop (feedback on) time-domain recording of bunch motion, bunch samples averaged to show the vertical centroid. The same beam conditions as Figure 3 (TMCI unstable) but motion is controlled by the feedback system. Vertical sensitivity is roughly $14 \mu\text{m}/\text{count}$

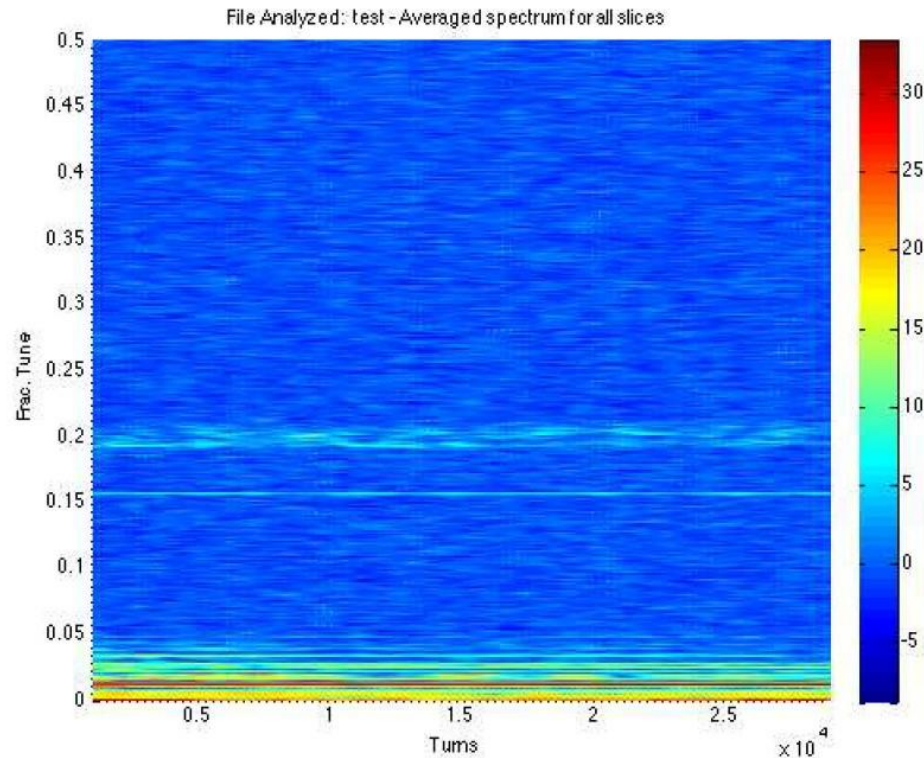

Figure 6: Closed-Loop (feedback on) spectrogram of Figure 5 transient. The beam is TMCI unstable in these conditions, Q26 lattice, $\nu_y = 0.185$ $\nu_s = 0.006$. The feedback control keeps the mode 1 and 2 unstable motion at the noise floor of the feedback receiver, or roughly 3 microns. A small amount of motion at mode zero is seen, this driven motion is reduced by the feedback gain.

Without derivation: emittance growth from injection errors

$$\frac{\varepsilon}{\varepsilon_0} = 1 + \frac{1}{2} \frac{\Delta x^2 + (\beta \Delta x' + \alpha \Delta x)^2}{\beta \varepsilon_0} \left(\frac{1}{1 + \tau_{DC} / \tau_d} \right)^2$$

ε_0 : beam emittance before injection

ε : beam emittance after damped injection oscillation

τ_{DC} : damping time of active feedback system

τ_d : filamentation time

Δx : position error at injection

$\Delta x'$: angle error at injection

α, β : twiss parameters at injection point

Even after perfect beam steering not all bunches can be injected into the LHC without position and/or angle error due to pulse-shape of kicker magnets

→ unwanted emittance growth

→ loss in luminosity/bunch instabilities

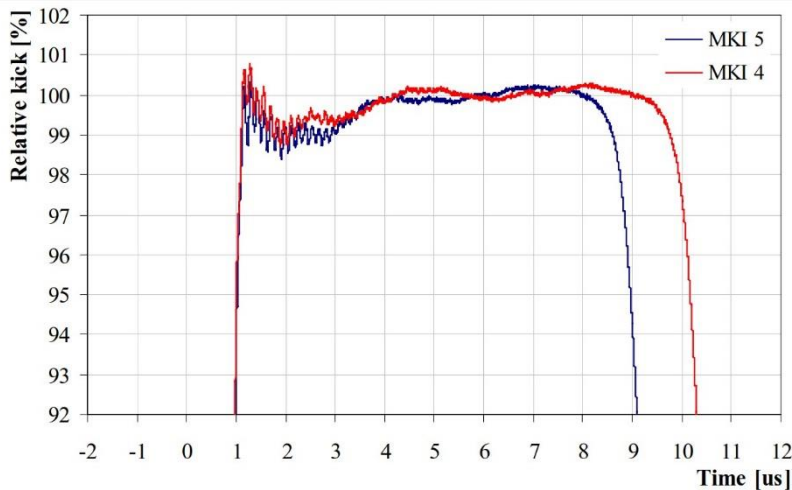

Figure 3: Measured LHC MKI injection kicker waveform, for different magnets and different pulse lengths.

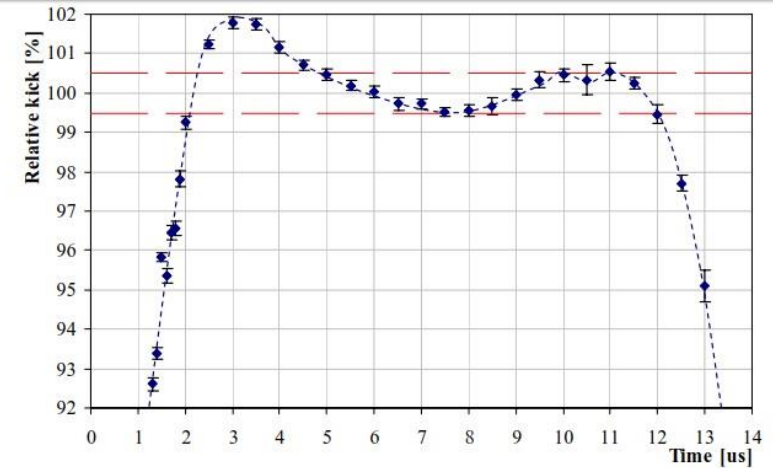

Figure 1: Ripple of SPS LSS6 extraction kickers (LHC beam 1) measured with beam.

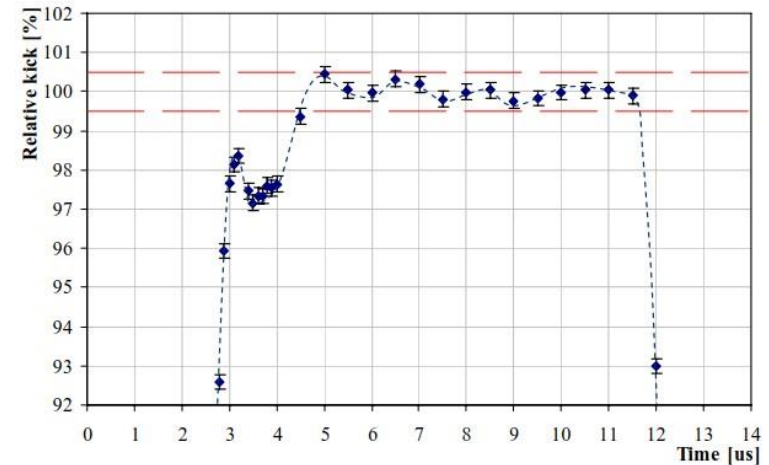

Figure 2: Ripple of SPS LSS4 extraction kickers (LHC beam 2) measured with beam.

Simulated emittance growth on various bunches after injection into the LHC:

tolerance is 2.5% emittance growth

only a few bunches above 1% emittance growth

Figures on past three slides from:
Emittance growth at the LHC injection from SPS and LHC kicker ripple, G. Kotzian et al, EPAC 2008

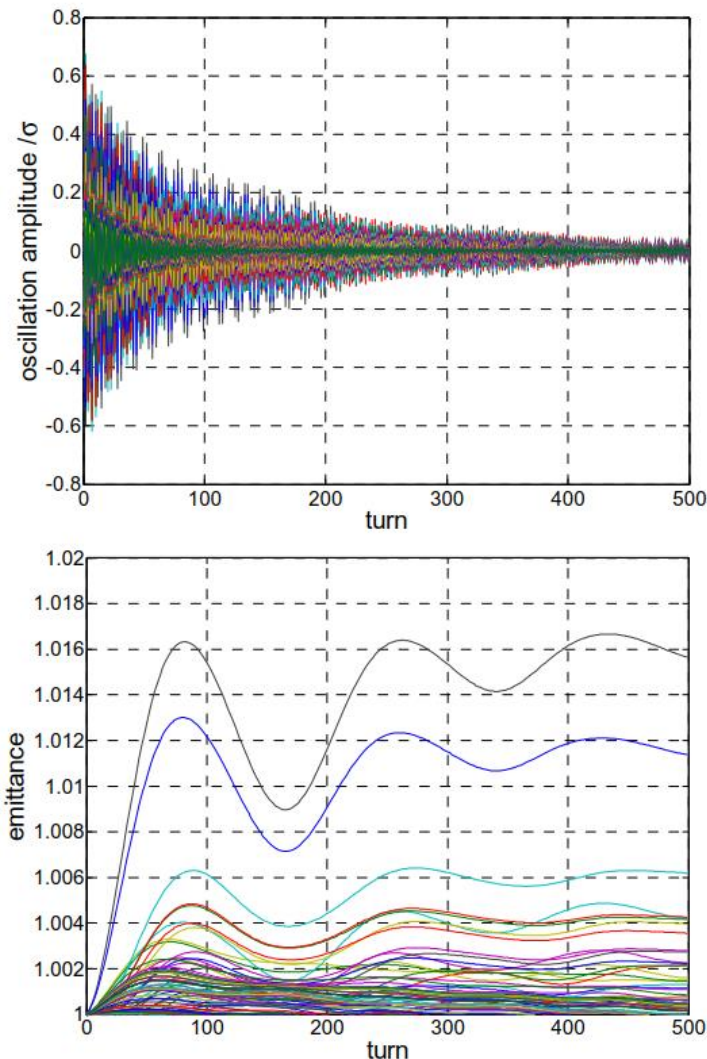

Figure 5: Evolution of single bunch oscillation amplitudes (top) and emittance increases (bottom) as a function of time after injection, using the measured MKI kick.

- Marco Lonza (Elettra) for his splendid animations
- Many papers about coupled-bunch instabilities and multi-bunch feedback systems (PETRA, KEK, SPring-8, DaΦne, ALS, PEP-II, SPEAR, ESRF, Elettra, SLS, CESR, HERA, HLS, DESY, PLS, BessyII, SRRC, SPS, LHC, ...)
- Intrabunch feedback at the SPS:
Wideband vertical intra-bunch feedback at the SPS
J. Fox (SLAC), W.Hofle (CERN) et al., proceedings of IPAC 2015, Richmond USA
- Injection damping: Verena Kain; CAS in Erice 2017

1. 3 slides : Power requirements for transverse dampers

The transverse motion of a bunch of particles not subject to damping or excitation can be described as a pseudo-harmonic oscillation with amplitude proportional to the square root of the β -function

$$x(s) = a \sqrt{\beta(s)} \cos \varphi(s), \quad \text{where} \quad \varphi(s) = \int_0^s \frac{d\bar{s}}{\beta(\bar{s})}$$

The derivative of the position, i.e. the angle of the trajectory is:

$$x' = -\frac{a}{\sqrt{\beta}} \sin \varphi + \frac{a\beta'}{2\sqrt{\beta}} \cos \varphi, \quad \text{with} \quad \varphi' = \frac{1}{\beta}$$

By introducing $\alpha = -\frac{\beta'}{2}$ we can write: $x' = \frac{a}{\sqrt{\beta}} \sqrt{1+\alpha^2} \sin(\varphi + \arctan \alpha)$

At the coordinate s_k , the electromagnetic field of the kicker deflects the particle bunch which varies its angle by k : as a consequence the bunch starts another oscillation

$x_1 = a_1 \sqrt{\beta} \cos \varphi_1$ which must satisfy the following constraints:

$$\begin{cases} x(s_k) = x_1(s_k) \\ x'(s_k) = x_1'(s_k) + k \end{cases}$$

By introducing $A = a\sqrt{\beta}$, $A_1 = a_1\sqrt{\beta}$ the two-equation two-unknown-variables system becomes:

$$\begin{cases} A \cos \varphi = A_1 \cos \varphi_1 \\ A \frac{\sqrt{1+\alpha^2}}{\beta} \sin(\varphi + \arctg(\alpha)) = A_1 \frac{\sqrt{1+\alpha^2}}{\beta} \sin(\varphi_1 + \arctg(\alpha)) + k \end{cases}$$

The solution of the system gives amplitude and phase of the new oscillation:

$$\begin{cases} A_1 = \sqrt{(A \sin \varphi - k\beta)^2 + A^2 \cos^2 \varphi} \\ \varphi_1 = \arccos\left(\frac{A}{A_1} \cos \varphi\right) \end{cases}$$

From $A_1 = \sqrt{(A \sin \varphi - k \beta)^2 + A^2 \cos^2 \varphi}$ if the kick is small ($k \ll \frac{A}{\beta}$) then $\frac{\Delta A}{A} = \frac{A - A_1}{A} \cong \frac{\beta}{A} k \sin \varphi$

In the linear feedback case, i.e. when the turn-by-turn kick signal is a sampled sinusoid proportional to the bunch oscillation amplitude, in order to maximize the damping rate the kick signal must be in-phase with $\sin \varphi$, that is in quadrature with the bunch oscillation

$$k = g \frac{A}{\beta} \sin \varphi \quad \text{with } 0 < g < 1$$

The optimal gain g_{opt} is determined by the maximum kick value k_{max} that the kicker is able to generate. The feedback gain must be set so that k_{max} is generated when the oscillation amplitude A at the kicker location is maximum:

$$g_{opt} = \frac{k_{max}}{A_{max}} \beta \quad \text{Therefore} \quad k = \frac{k_{max}}{A_{max}} A \sin \varphi$$

For small kicks $\frac{\Delta A}{A} \cong \frac{k_{max}}{A_{max}} \beta \sin^2 \varphi$

the relative amplitude decrease is monotonic and its average is: $\left\langle \frac{\Delta A}{A} \right\rangle \cong \frac{\beta k_{max}}{2 A_{max}}$

The average relative decrease is therefore constant, which means that, in average, the amplitude decrease is exponential with time constant τ (damping time) given by:

$$\frac{1}{\tau} = \left\langle \frac{\Delta A}{A} \right\rangle \frac{1}{T_0} = \frac{\beta k_{max}}{2 A_{max} T_0} \quad \text{where } T_0 \text{ is the revolution period.}$$

By referring to the oscillation at the BPM location:

$$\frac{1}{\tau} = \frac{k_{max}}{2 T_0 A_{Bmax}} \sqrt{\beta_k \beta_B}$$

A_{Bmax} is the max oscillation amplitude at the BPM

For relativistic particles, the change of the transverse momentum p of the bunch passing through the kicker can be expressed by:

$$\Delta p = \frac{e}{c} V_{\perp} \quad \text{where} \quad V_{\perp} = \int_0^L (\bar{E} + c \times \bar{B})_{\perp} dz \quad \text{is the kick voltage and} \quad p = \frac{E_B}{c}$$

e = electron charge, c = light speed, \bar{E}, \bar{B} = fields in the kicker, L = length of the kicker, E_B = beam energy

$$V_{\perp} \text{ can be derived from the definition of kicker shunt impedance: } R_k = \frac{V_{\perp}^2}{2P_k}$$

The max deflection angle in the kicker is given by:

$$k_{\max} = \frac{\Delta p}{p} = e \frac{V_{\perp}}{E_B} = \left(\frac{e}{E_B} \right) \sqrt{2P_k R_k}$$

From the previous equations we can obtain the power required to damp the bunch oscillation with time constant τ :

$$P_k = \frac{2}{R_k \beta_k} \left(\frac{E_B}{e} \right)^2 \left(\frac{T_0}{\tau} \right)^2 \left(\frac{A_{B\max}}{\sqrt{\beta_B}} \right)^2$$