

Accelerator Types and Needs for DSP

Tom Shea
ORNL

Outline

- Overview of Accelerators
- DSP Technology Intro
- Performance Challenges With Examples
- Considerations of the Accelerator Environment
- Final Comments

Overview of Accelerators

Accelerator Inventory

World wide inventory of accelerators, in total 15,000. The data have been collected by W. Scarf and W. Wieszczycka (See U. Amaldi Europhysics News, June 31, 2000)

Category	Number
Ion implanters and surface modifications	7,000
Accelerators in industry	1,500
Accelerators in non-nuclear research	1,000
Radiotherapy	5,000
Medical isotopes production	200
Hadron therapy	20
Synchrotron radiation sources	70
Nuclear and particle physics research	110

Acceleration Techniques

$$\Delta W = qV_0$$

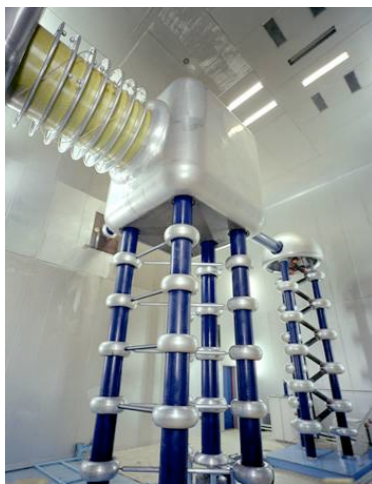
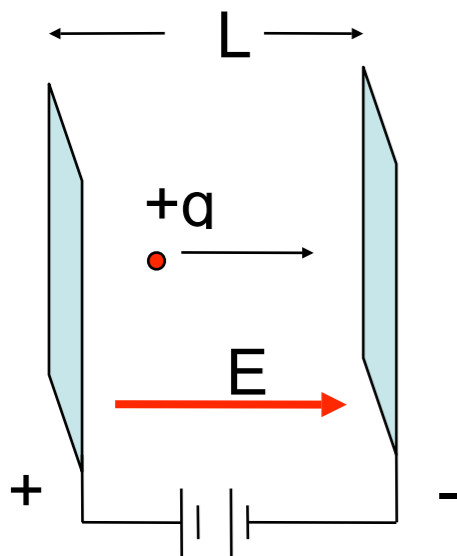

Two approaches for accelerating with time-varying fields (to get above 20 MeV/n or so)

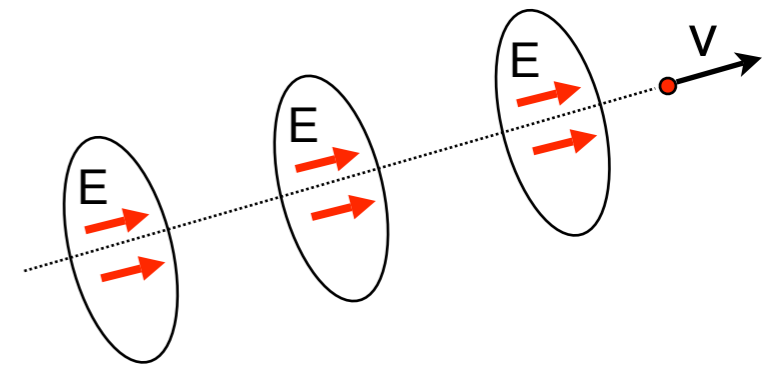

Linear Accelerators

Use many accelerating cavities through which the particle beam passes once: Linacs

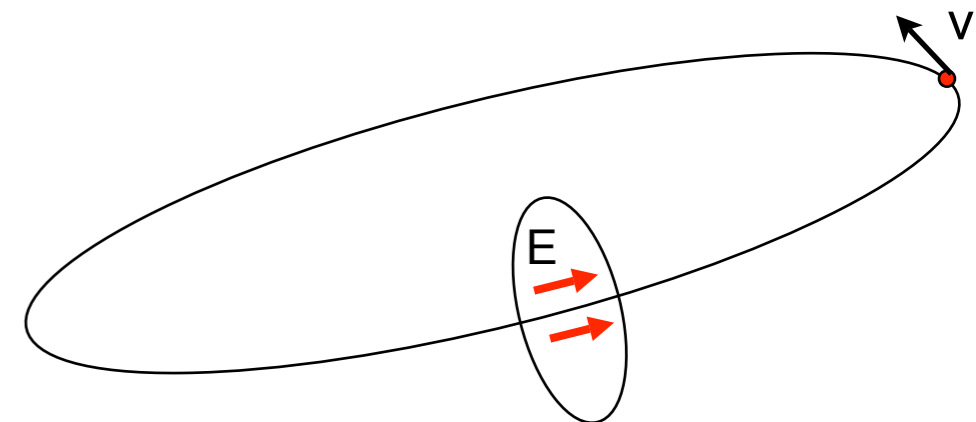

Circular Accelerators

Use one or a small number of Radio-frequency accelerating cavities and make use of repeated passage through them. This approach is realized in circular accelerators: Cyclotrons, synchrotrons and their variants

Linac Concept

- Ising and Wideroe suggested to repeatedly apply a much smaller voltage in a linear accelerator by using time-varying fields
- In this way, a high particle beam energy could be attained by repeatedly applying voltage “kicks”

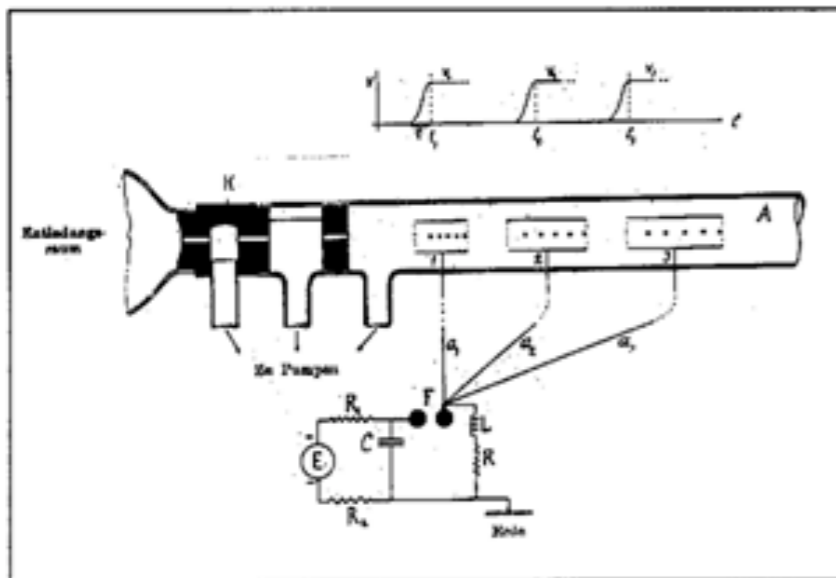

Ising's idea



R. Wideroe

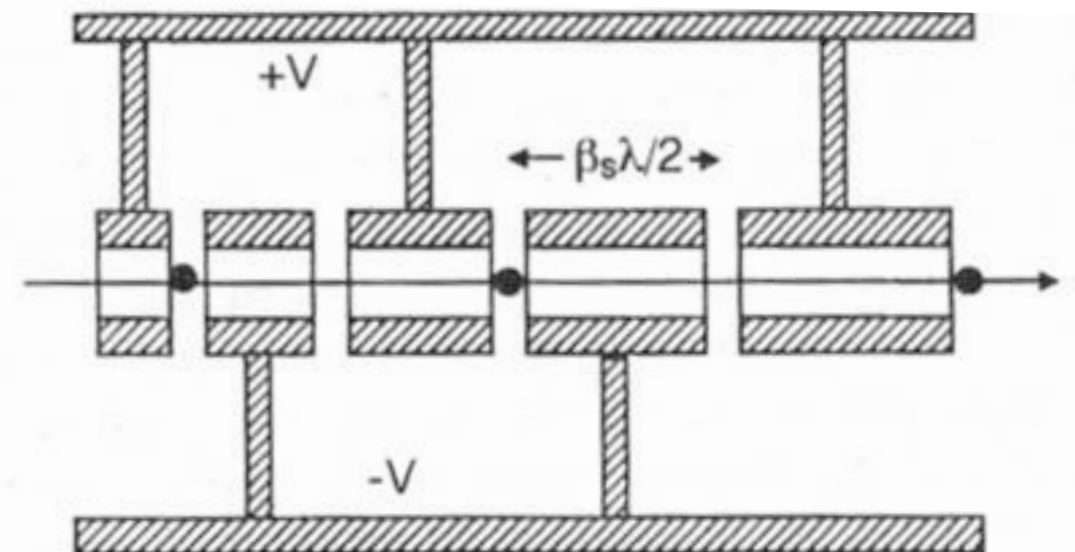

Figure 4.4 Wideroe or Sloan-Lawrence or interdigital structure.

Modern Linacs

- The two largest proton linear accelerators are the LANSCE linac at Los Alamos (800 MeV) and the Spallation Neutron Source Linac at ORNL (1000 MeV)
- Largest linac is at SLAC; largest under consideration is ILC (31 km total length)
- Electron and hadron linacs now will look similar: most recent and future projects have settled on superconducting cavities.



Stanford Linear Accelerator

ILC

- 500 GeV lepton machine
- peak luminosity of $2e34$

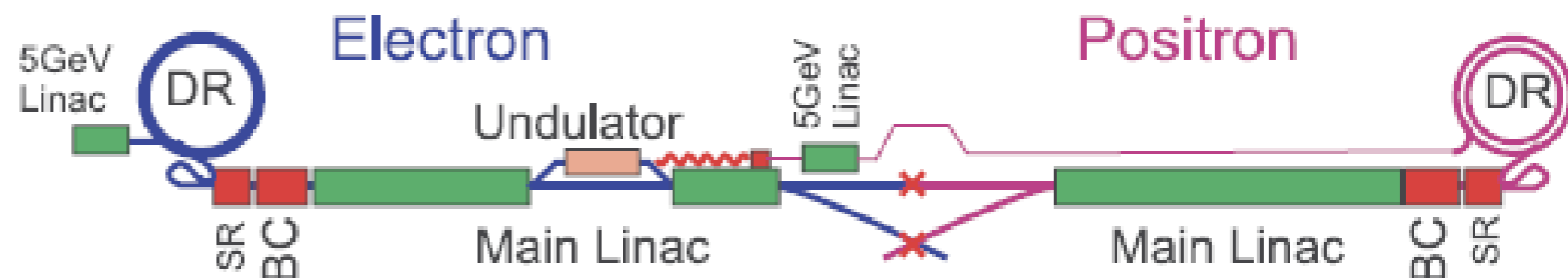

Circular Machines

Lawrence's Application of Wideroe's Idea: The Cyclotron

not being able to read German easily, I merely looked at the diagrams and photographs of Wideroe's apparatus and from the various figures in the article readily realized understood the his general approach to the problem - i.e. the multiple acceleration of the positive ions by ^{appropriate} application of radio frequency oscillating voltages to a series of cylindrical electrodes



The synchrotron concept - ramped magnets for constant radius - was first proposed in 1943 by the Australian physicist Mark Oliphant.

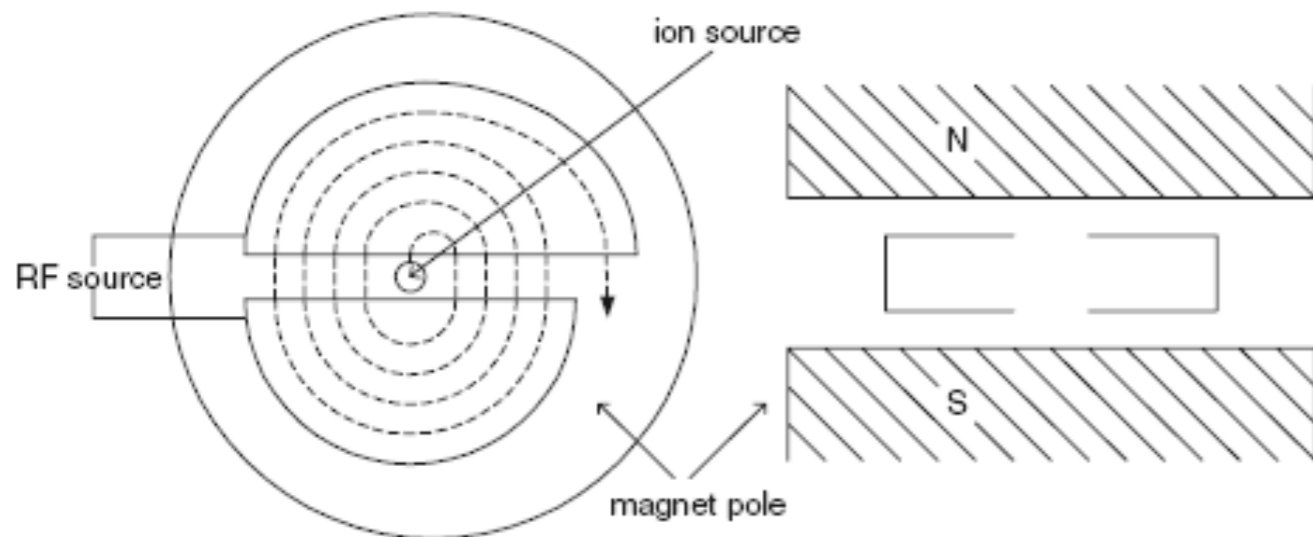
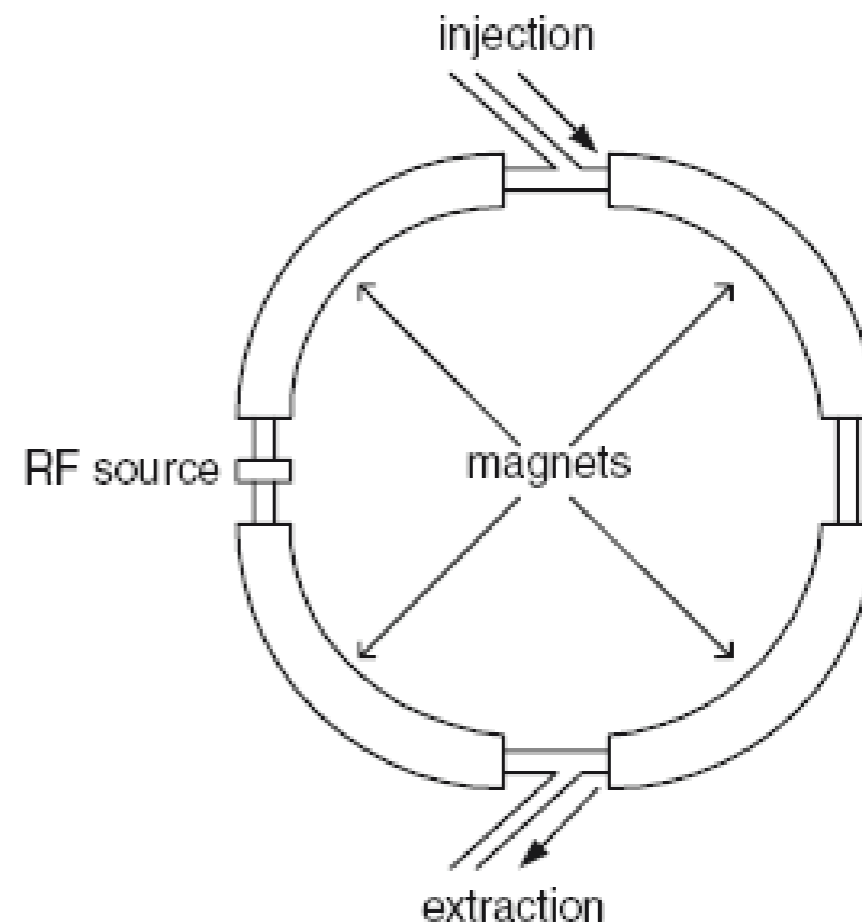

$$\frac{1}{\rho[m]} = 0.3 \frac{B[T]}{\beta E[GeV]} = 0.3 \frac{B[T]}{cp[GeV]}$$

Strong-focusing Synchrotrons

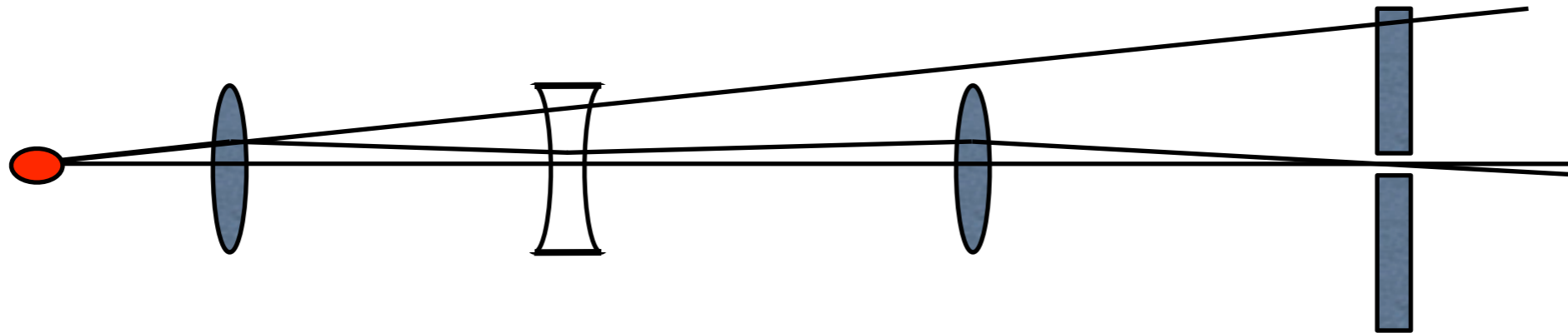

The synchrotron concept was first proposed in 1943 by the Australian physicist Mark Oliphant. “Strong” or “Alternating Gradient” focusing concept first applied to particle accelerators by Courant, Livingston and Snyder. First AG synchrotron: Cornell in 1954.

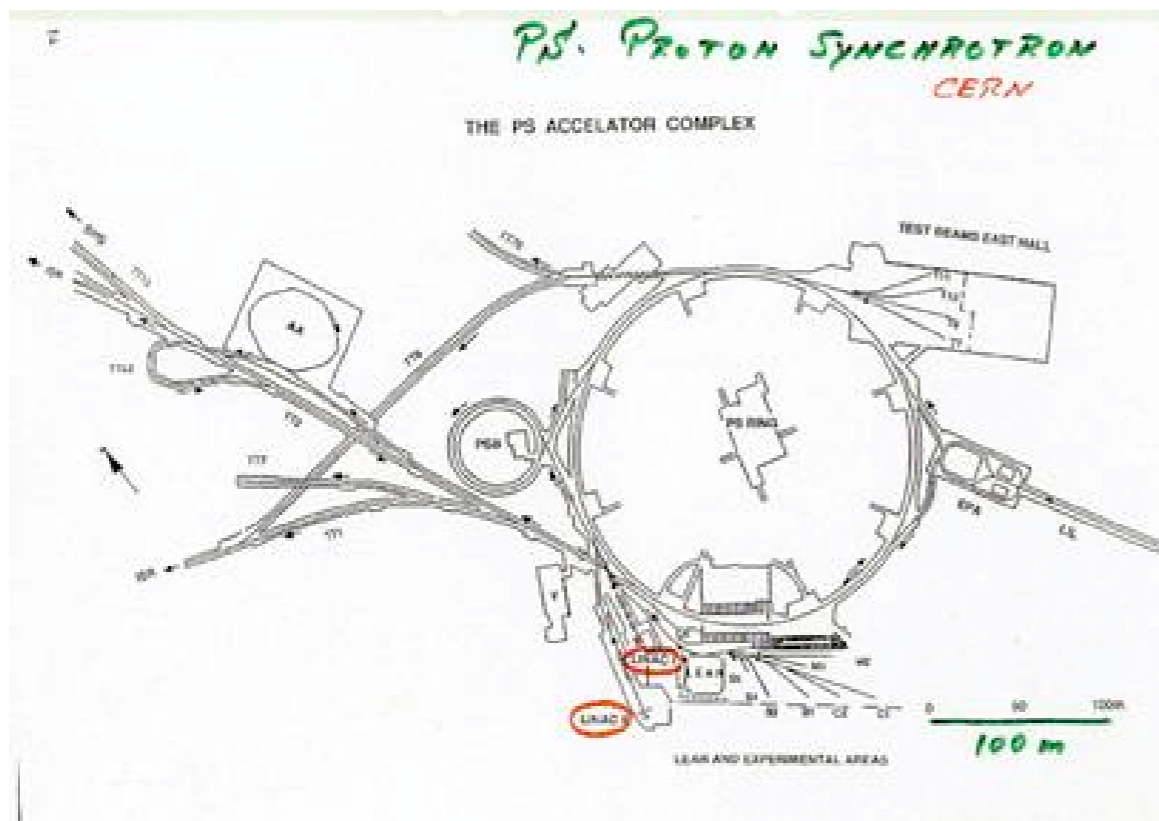

CERN PS (~28 GeV) started operations in 1959.



Brookhaven AGS (~33 GeV) under construction in 1957. Started operations in 1960.

Energy

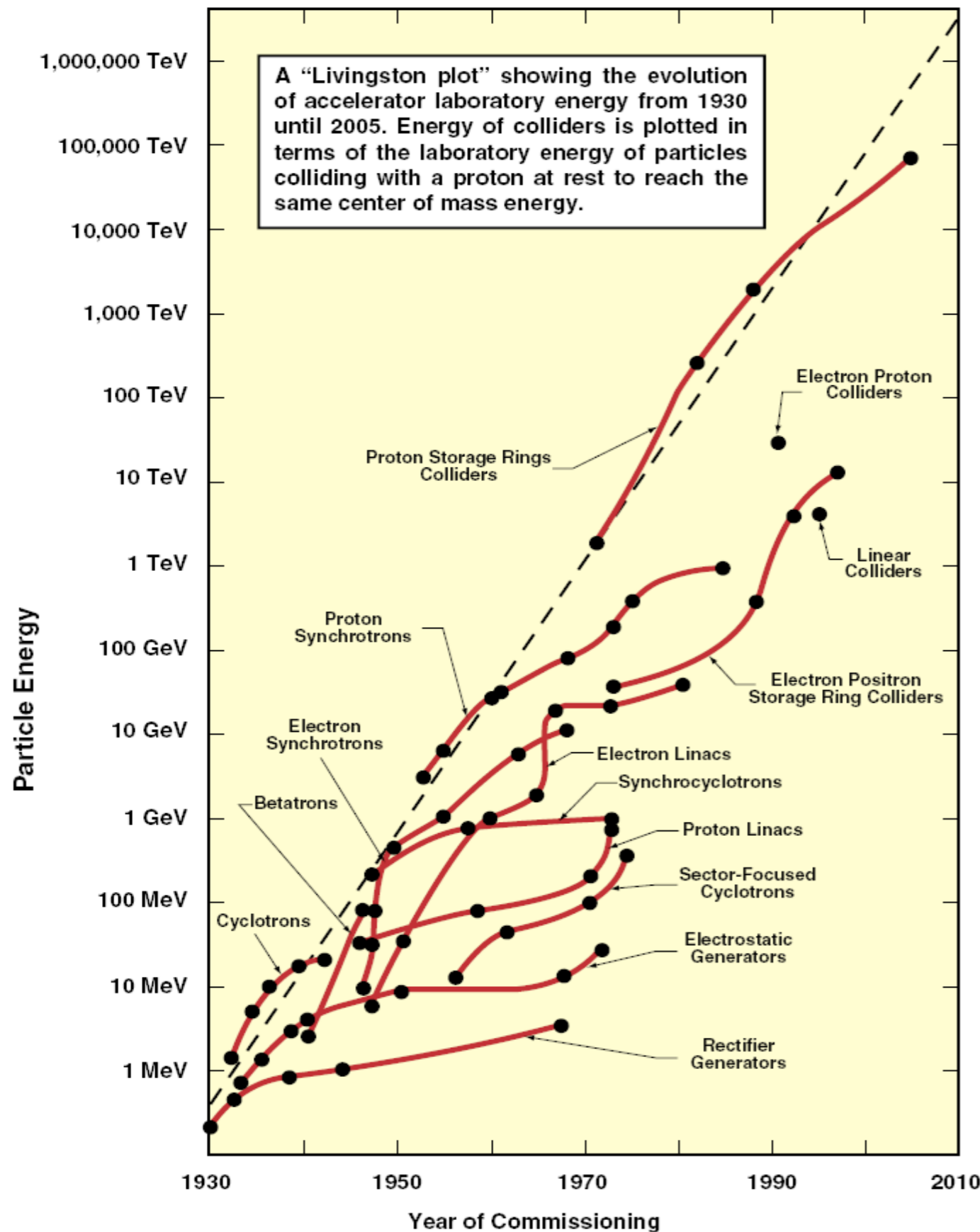

$$E=mc^2$$

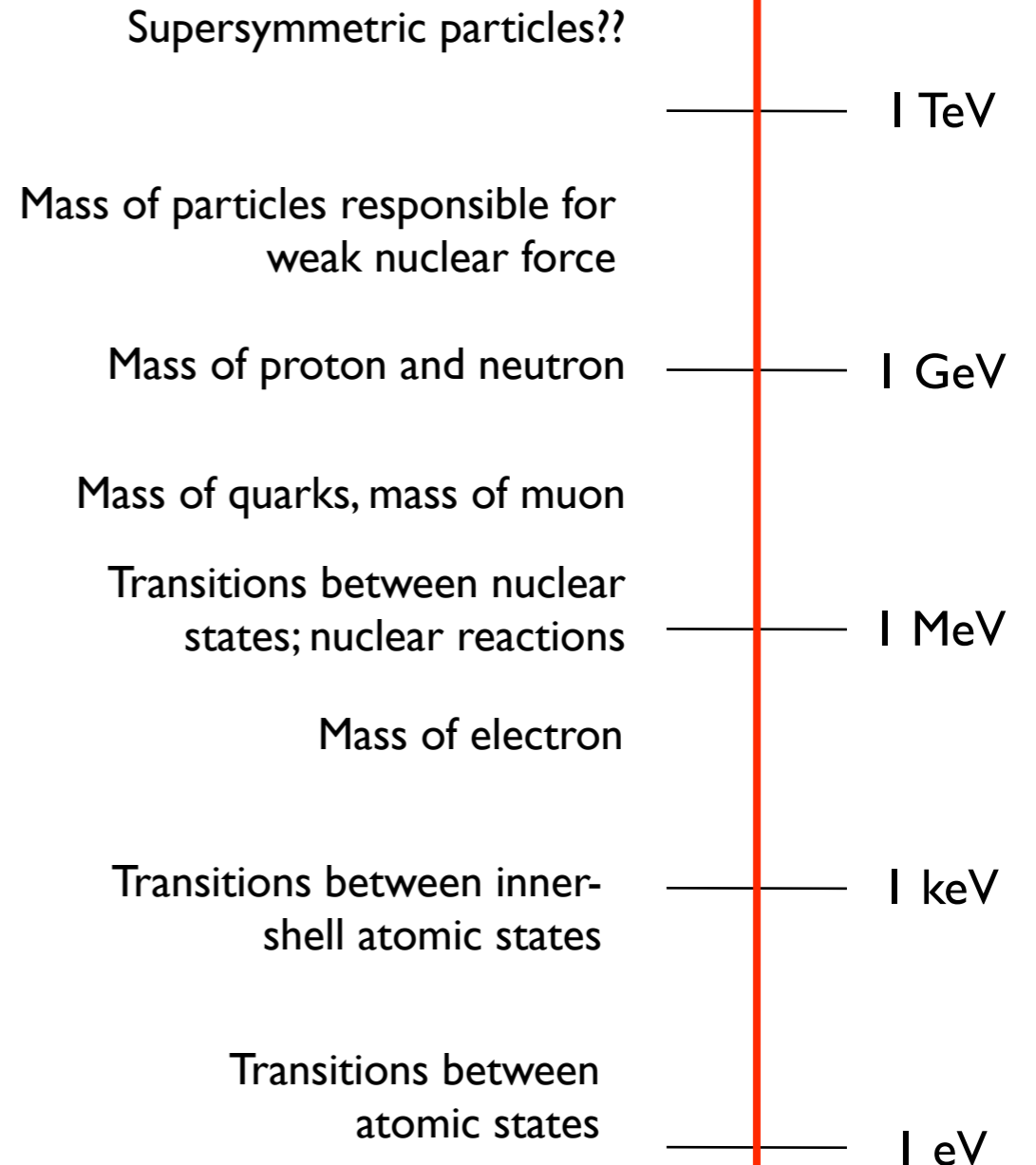

Increasing intensity

PS

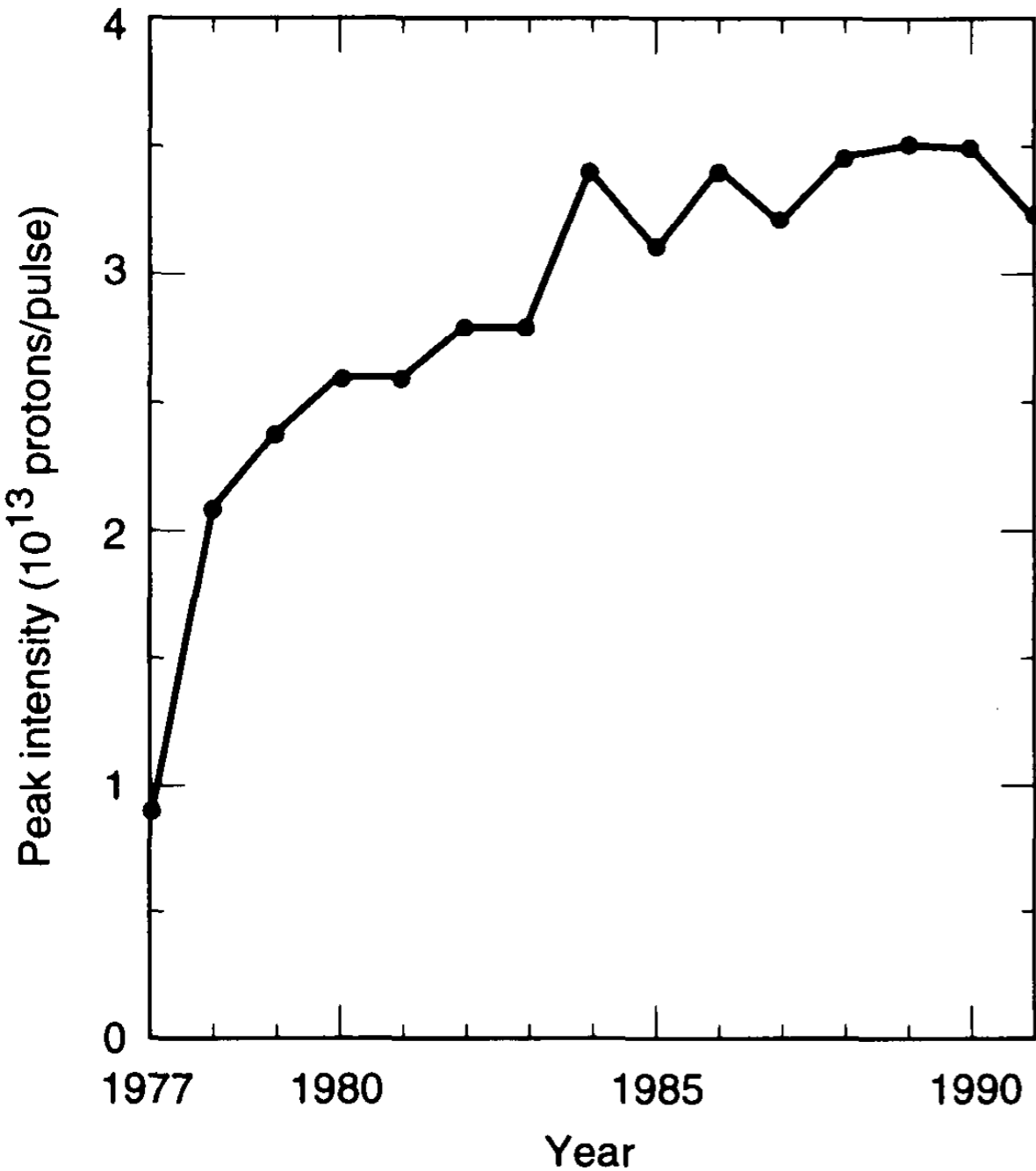

AGS

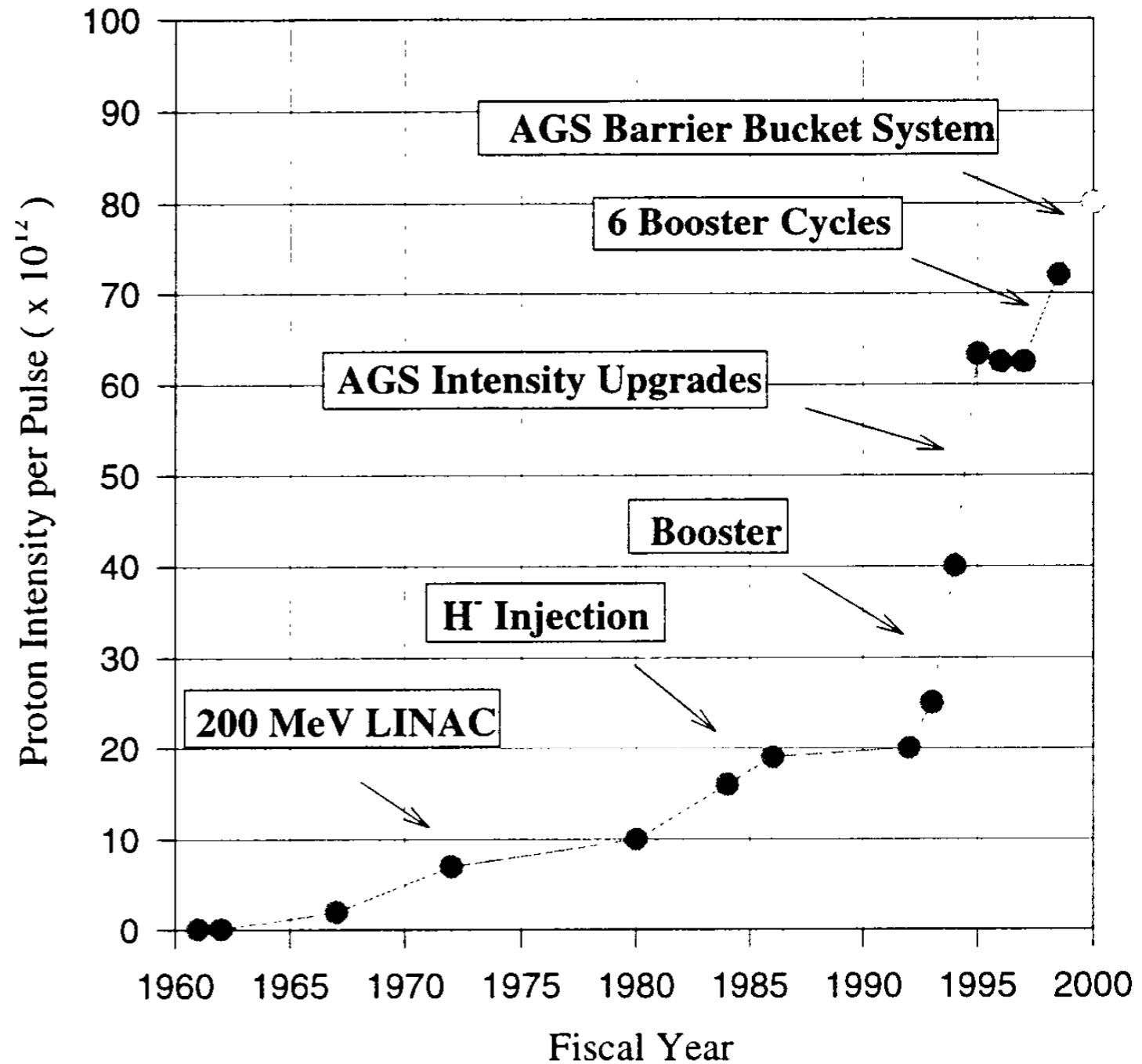

Colliders

- Circular or linear, common goal is to maximize center-of-mass energy available for particle production

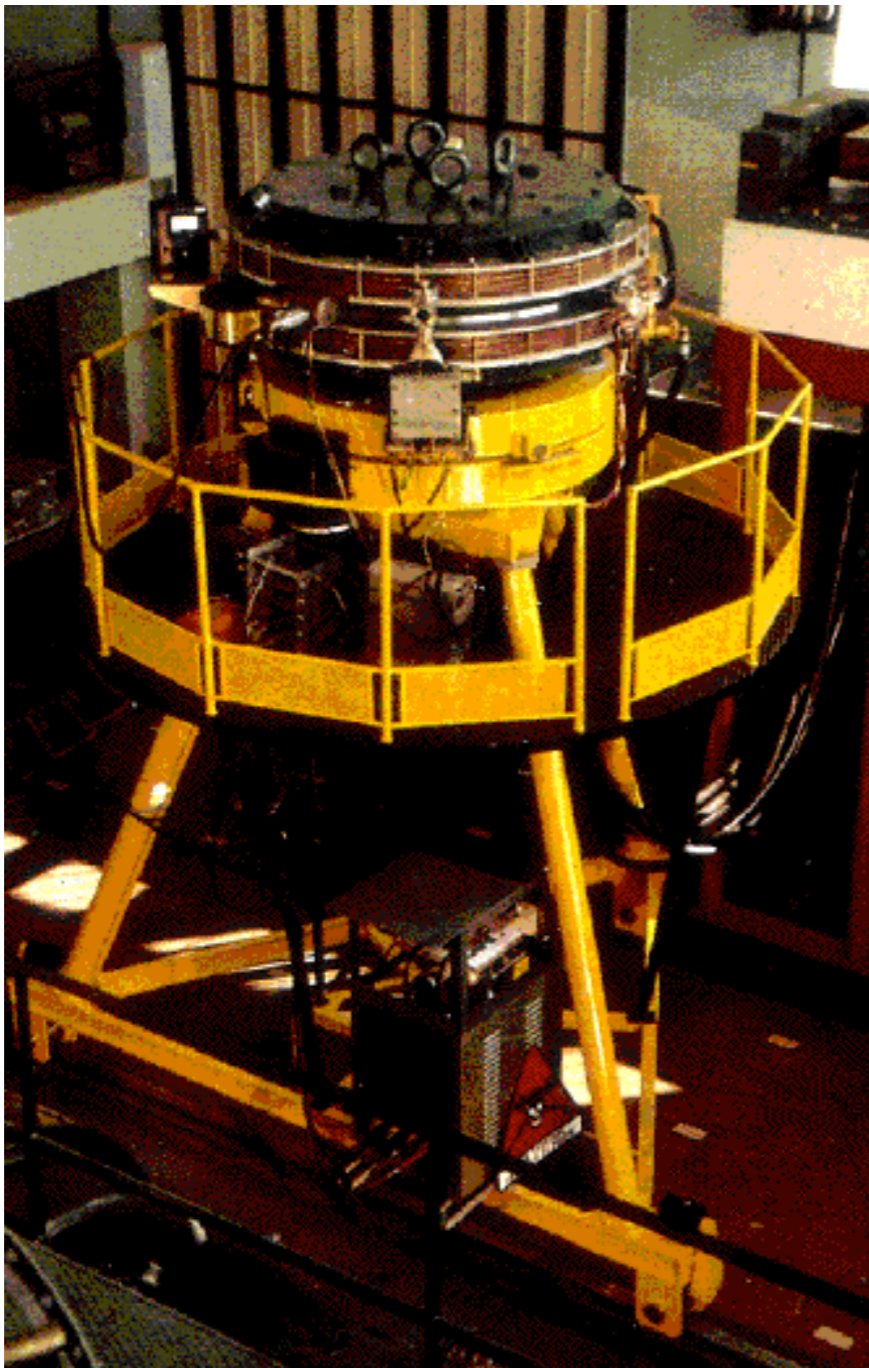

Bruno Touschek built the first successful electron-positron collider, ADA, at Frascati, Italy (1960)

Eventually, went up to 3 GeV

Collider Figure of Merit: Luminosity

- probability of an interesting reaction can be small
- to make a discovery in your lifetime: small bunches, lots of particles per bunch, high bunch rate, reliable operation of **accelerator complex**

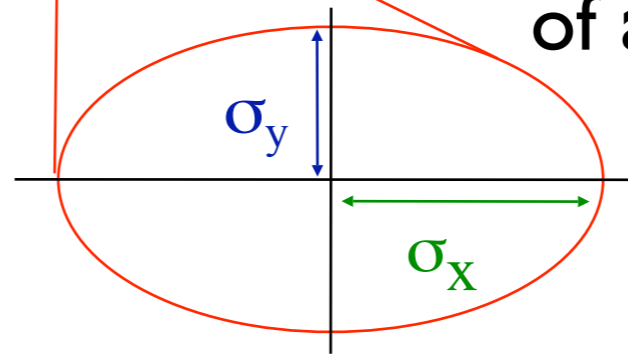
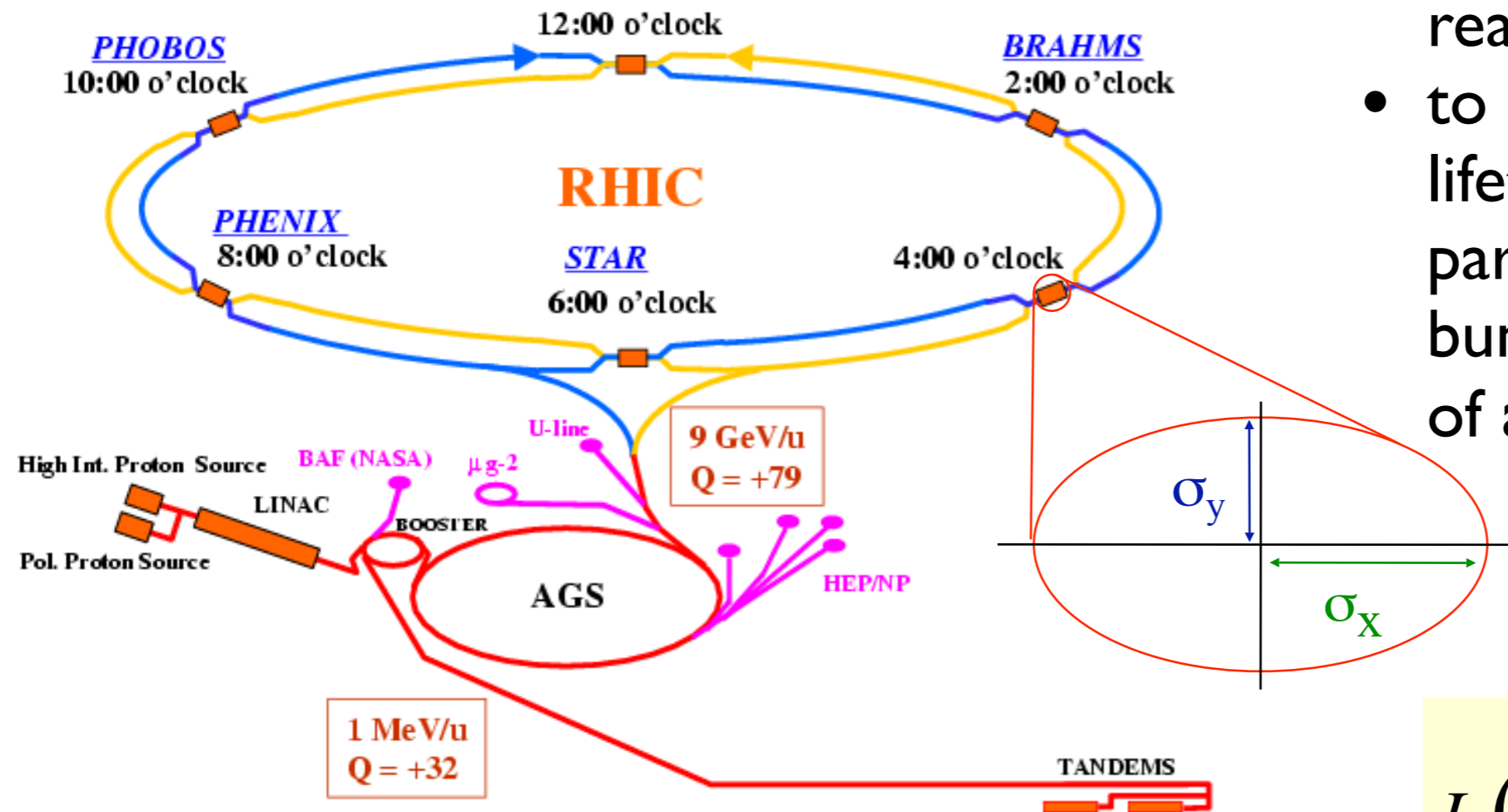

for Gaussian beam

$$I_1(x, y) = \frac{n_1}{2\pi\sigma_x\sigma_y} e^{-\frac{x^2}{2\sigma_x^2}} e^{-\frac{y^2}{2\sigma_y^2}}$$

Luminosity = number of interactions per unit area per unit time:

$$L = f \int_{-\infty}^{\infty} dx_1 dy_1 dx_2 dy_2 I_1(x_1, y_1) I_2(x_2, y_2) \delta(x_1 - x_2) \delta(y_1 - y_2)$$

$$= f \frac{n_1 n_2}{4\pi\sigma_x \sigma_y}$$

n_1, n_2 = particles per bunch
 f = frequency of bunch collisions

Luminosity Trends

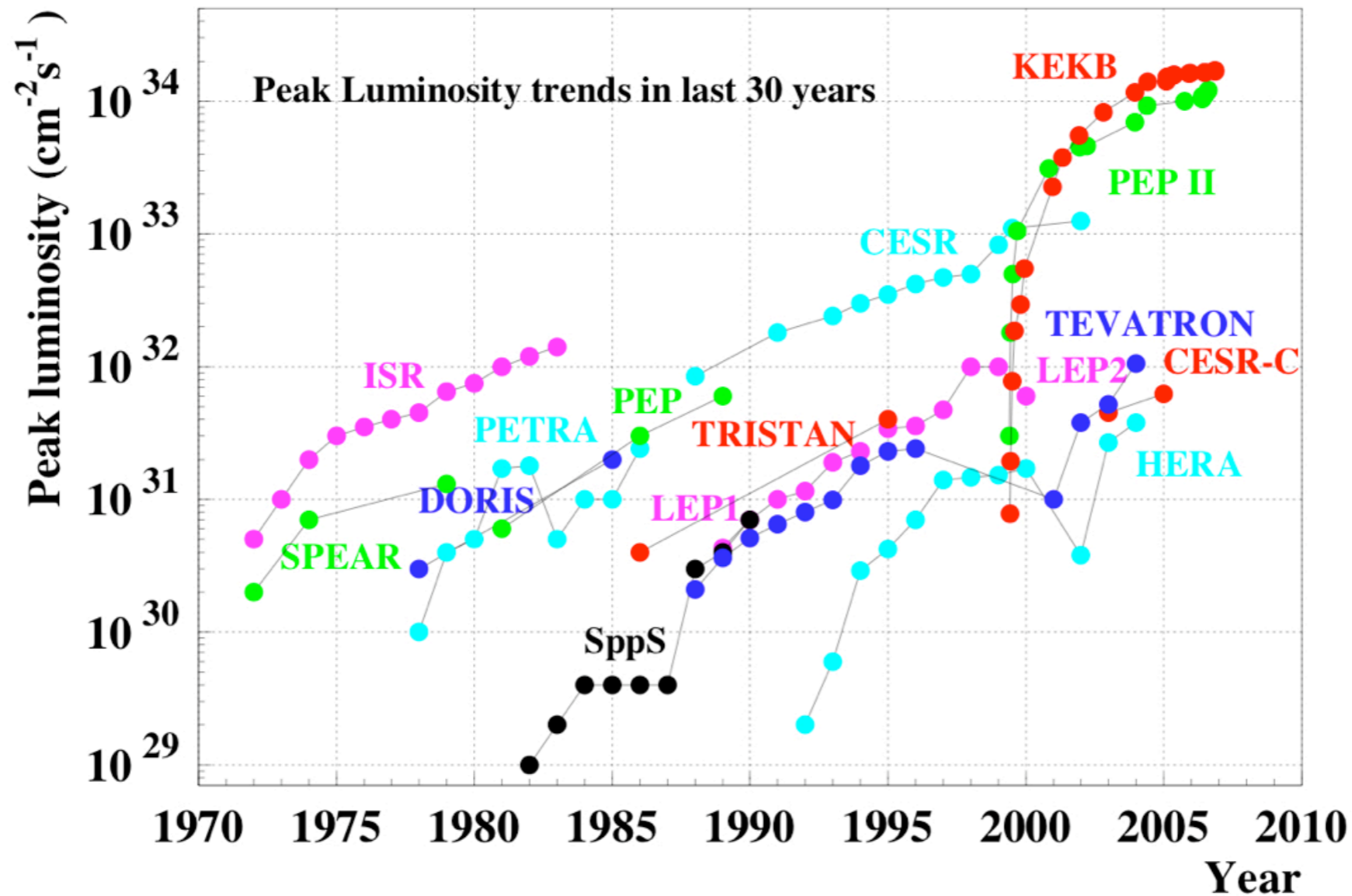

	ILC $e^- + e^+$	RHIC		LHC	
		p+p	Au+Au	p+p	Pb+Pb
Maximum beam energy (TeV/u)	0.25	0.25	0.10	7.0	2.76
Luminosity ($10^{30} \text{ cm}^{-2}\text{s}^{-1}$)	2×10^4	6	5×10^{-4}	10^4	10^{-3}

Secondary Beams

- Secondary beams of neutrons and photons
- Produced at or moderated to wavelengths appropriate for the study of materials and their properties
- Also, neutrinos, radioactive ion beams etc. for physics

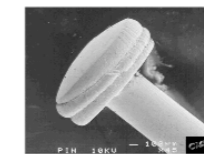
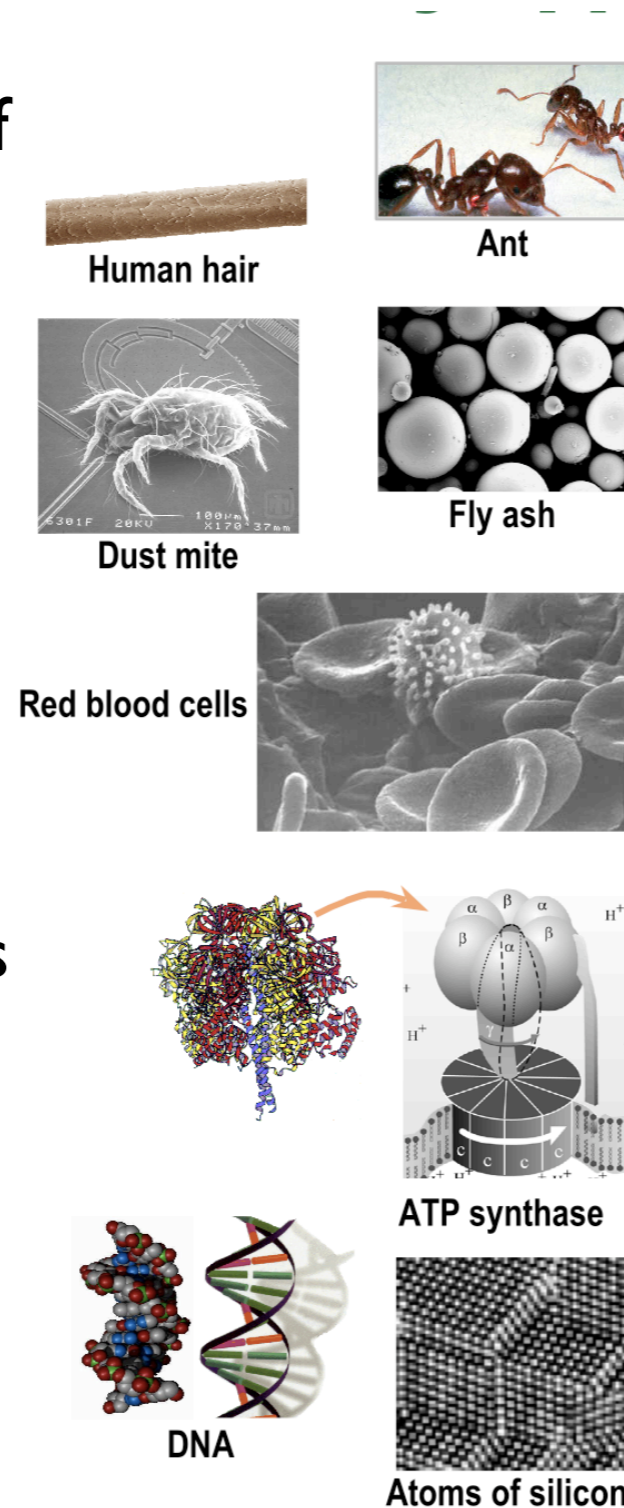

Head of a pin

Microelectromechanical Devices

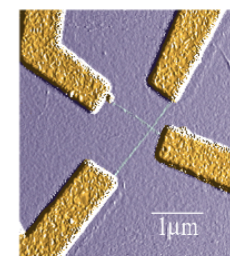
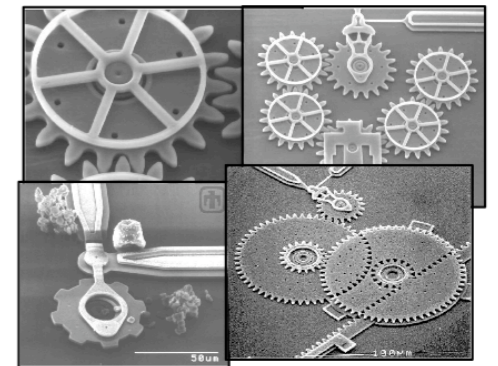

Nanotube electrode

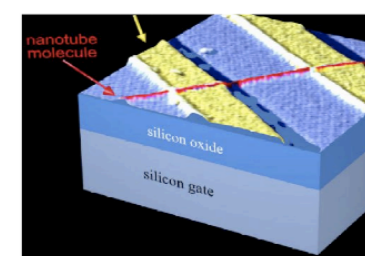

Nanotube transistor

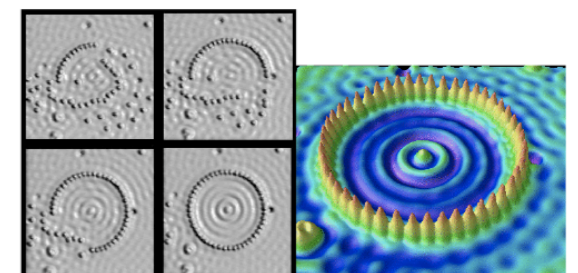

Quantum corral of 48 iron atoms

Accelerator-Based Light Sources

70 MeV electron synchrotron at General Electric, Schenectady, NY, 1947

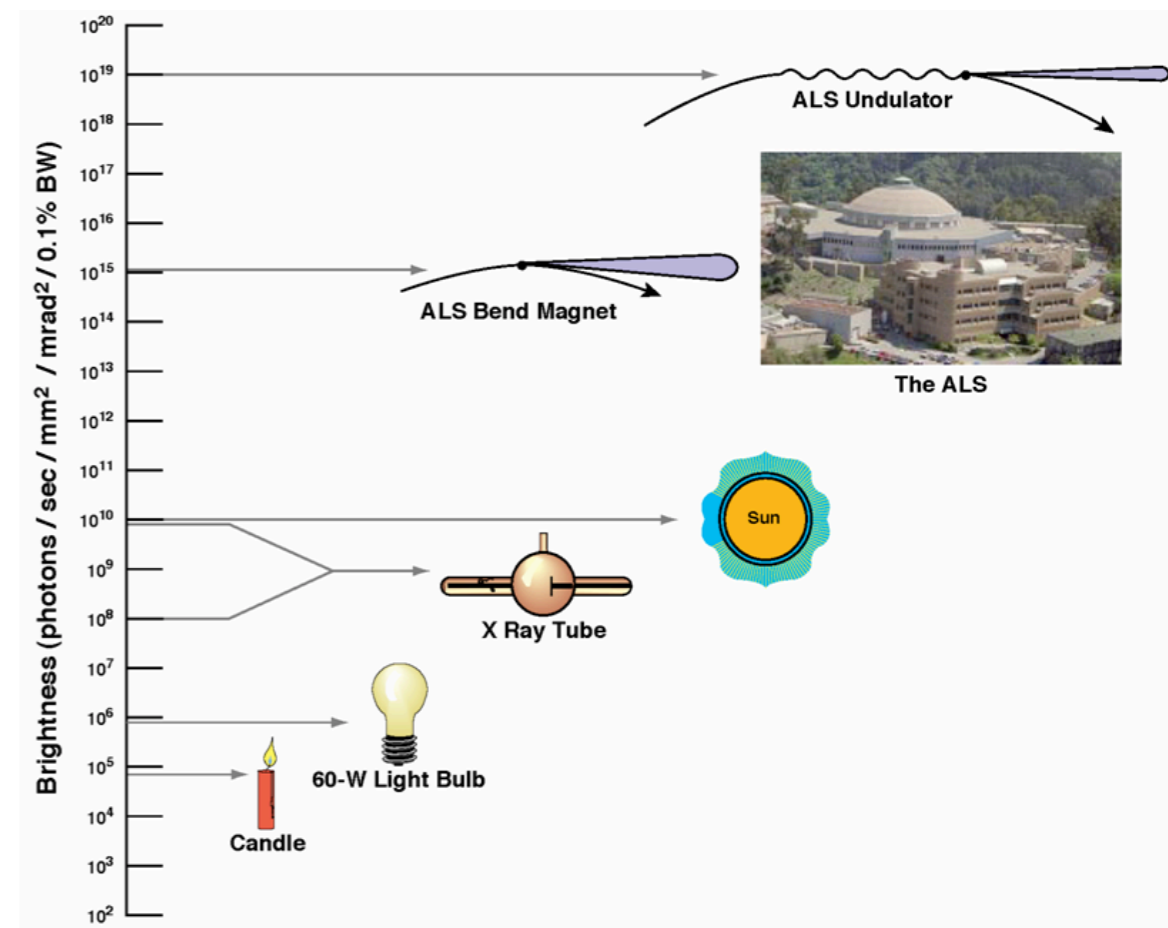
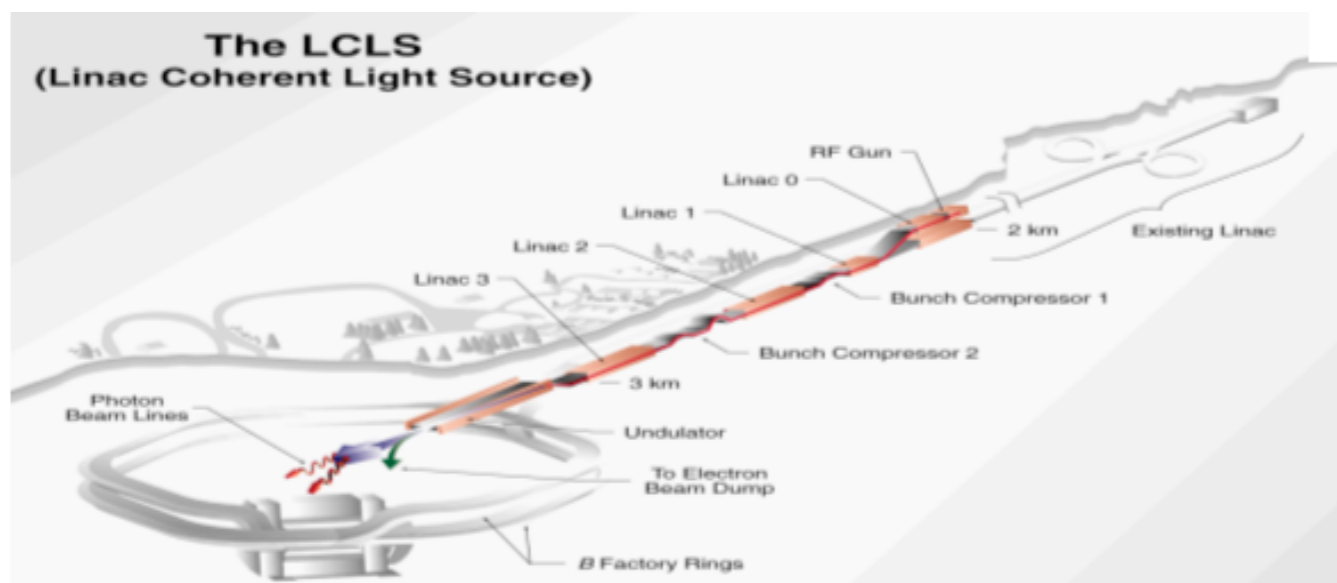
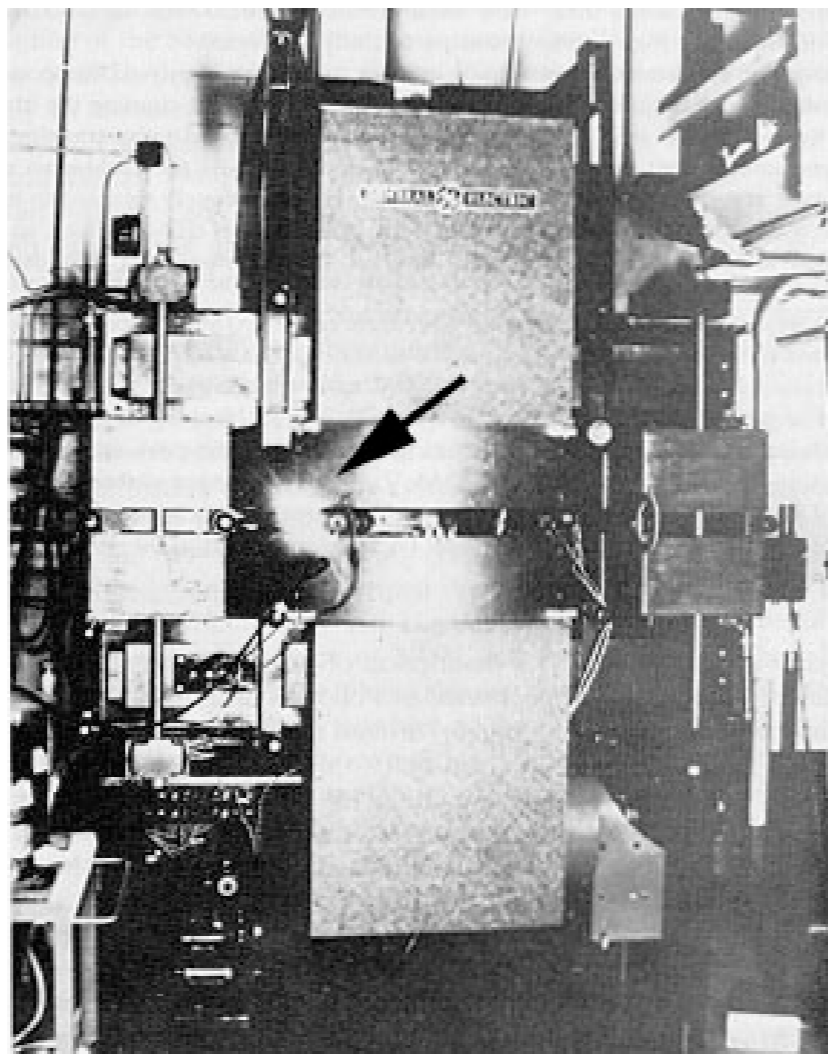

Light Source Brightness

4th generation up here ↑

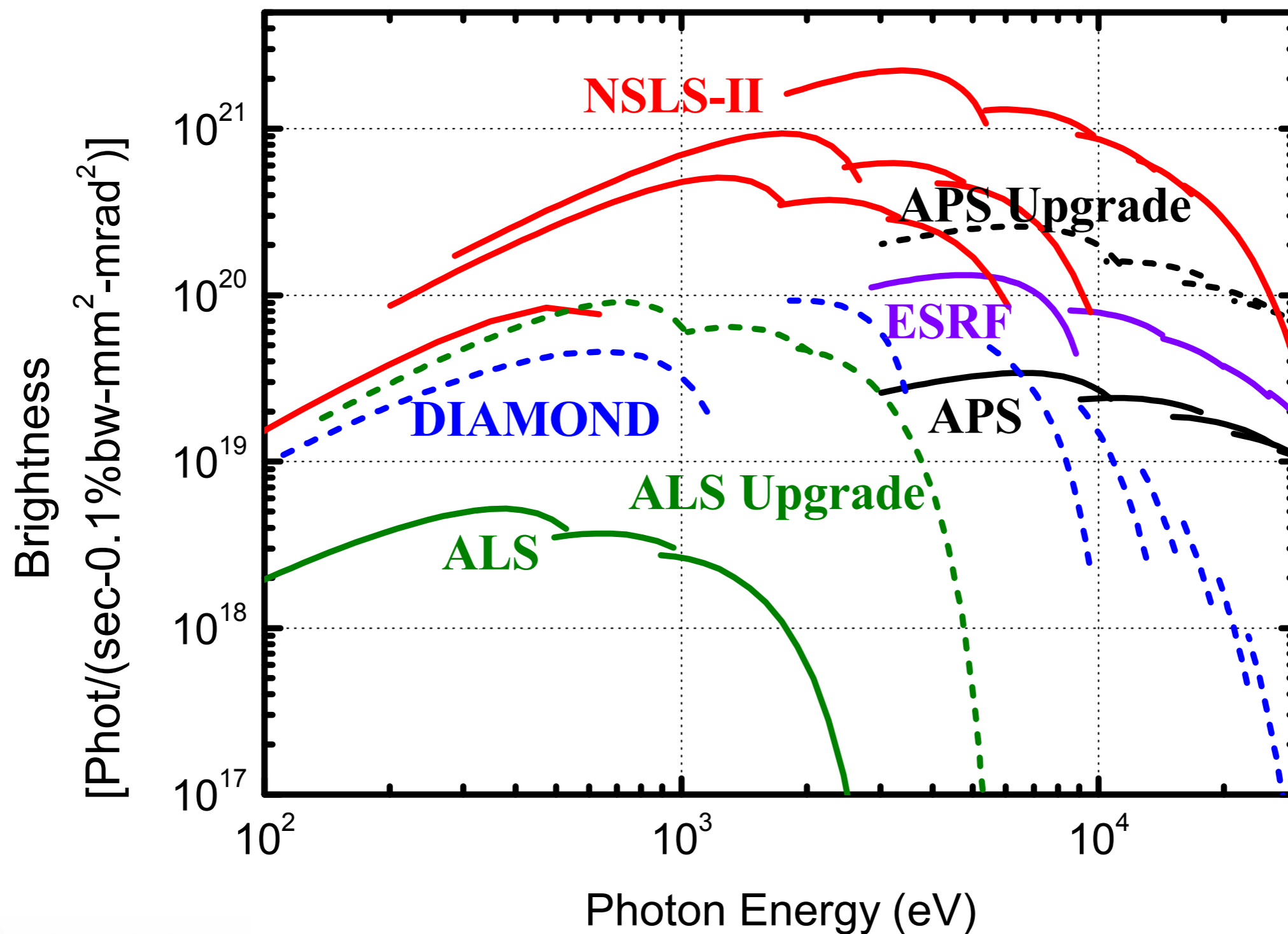

Accelerator-Based Neutron Sources

- High-energy protons are used to generate neutrons from a heavy metal target via the spallation process
- Several labs, ISIS(RAL, UK), LANSCE (Los Alamos), SNS (ORNL), IPNS (Argonne), J-PARC (Japan) operate or are building these types of machines
- They use ~ 1 GeV protons accelerated by linacs or synchrotrons

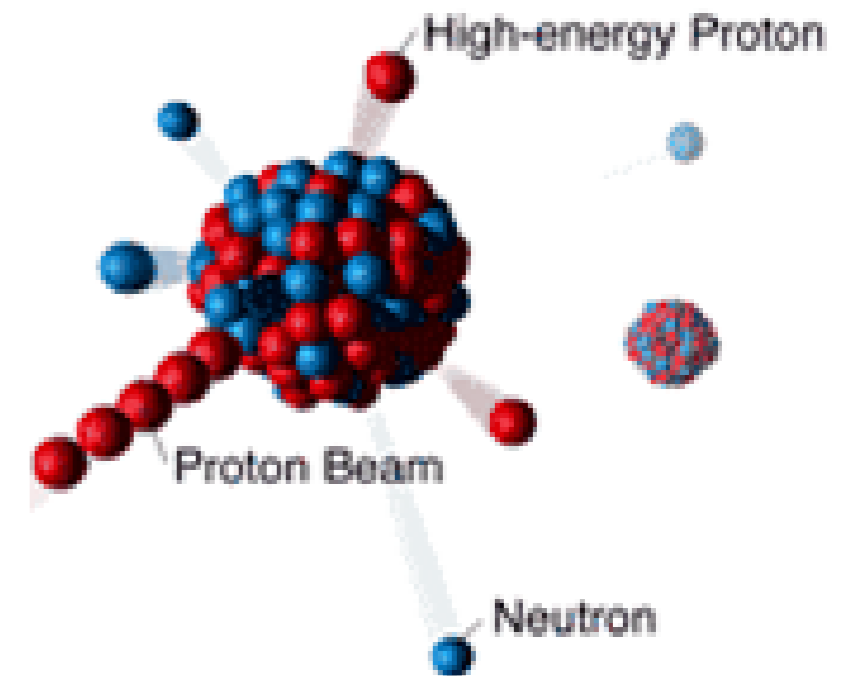

Neutron Source Performance

Reactor-based source:

- neutrons produced by fission reactions
- Continuous neutron beam
- 1 neutron/fission

Accelerator based source:

- 25 neutrons/proton for Hg
- A pulsed beam with precise t_0 allows neutron energy measurement via TOF

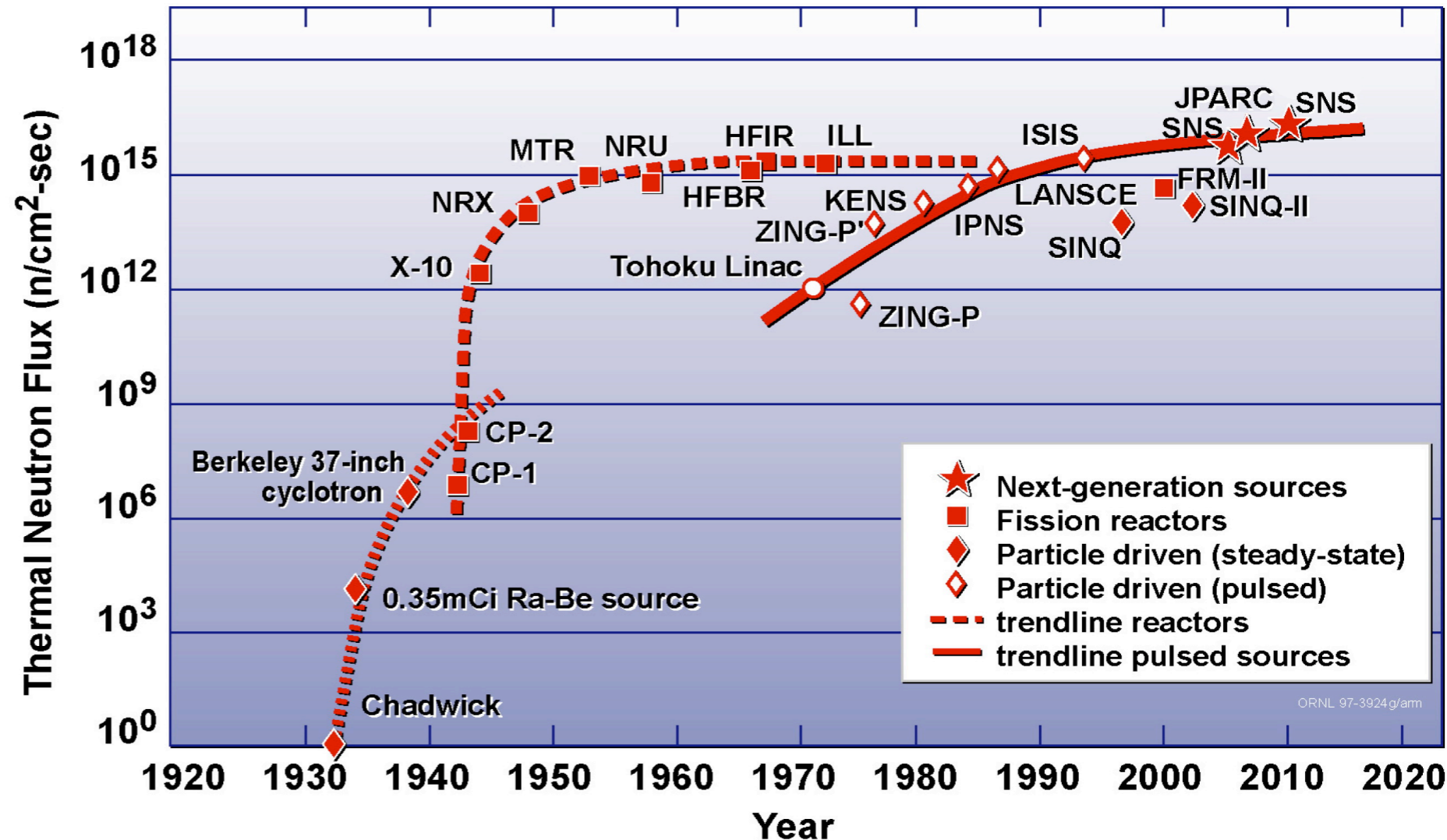

(Updated from *Neutron Scattering*, K. Skold and D. L. Price: eds., Academic Press, 1986)

Reactors have reached the limit at which heat can be removed from the core
 Pulsed sources have not yet reached their limit and hold out the promise of higher intensities: **Proportional to proton beam intensity on target.**

**Meanwhile, back in the
electronics lab...**

Once Upon a Time, there was a job called: “Audio Frequency Analog Engineer”

Their products:

- Mixers
- Equalizers
- Crossover networks
- Reverbs
- Fuzz Boxes....

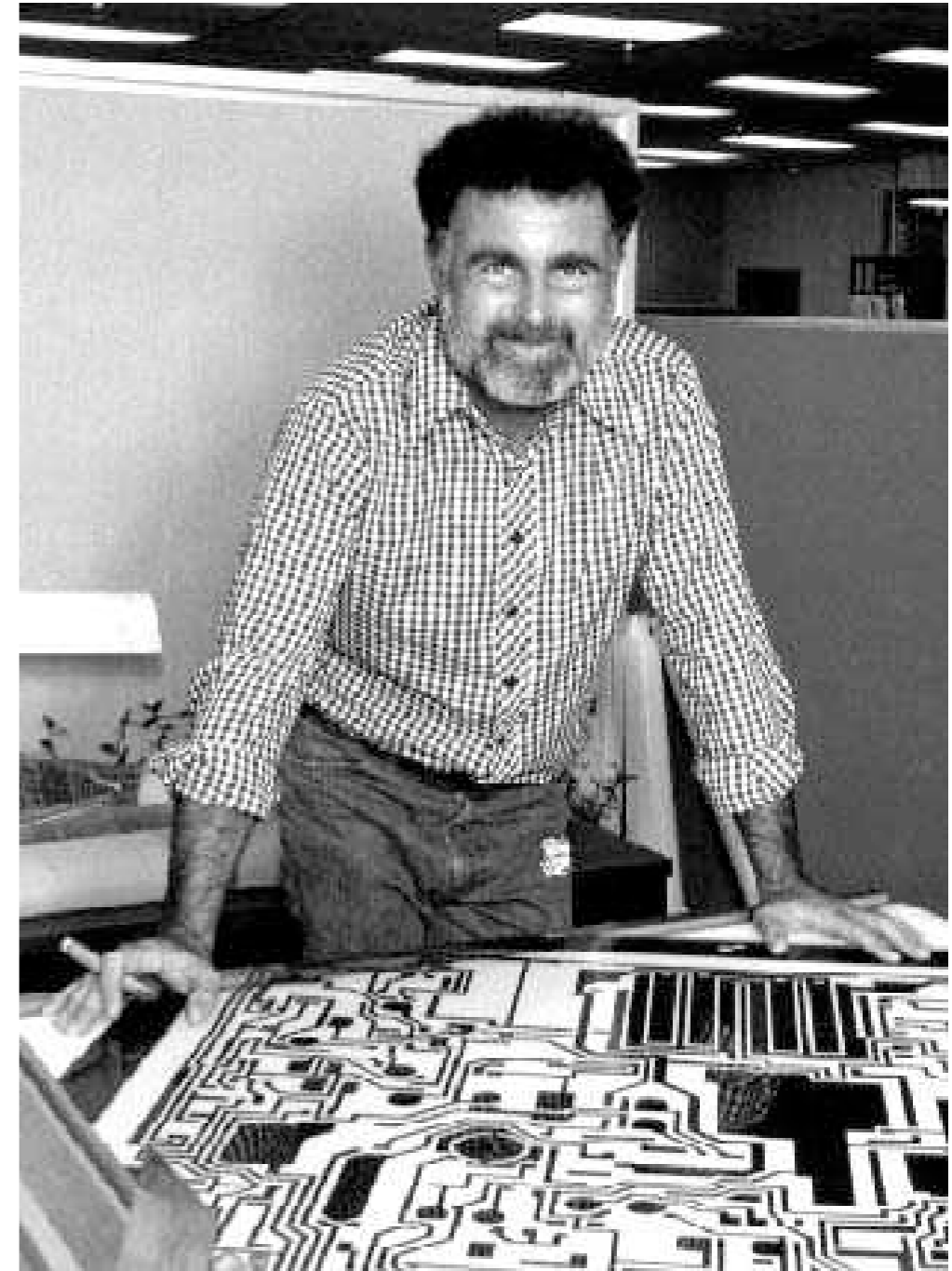

*Bob Widlar, “inventor of the IC Op-Amp” and other analog gems
<http://www.elecdesign.com/Globals/PlanetEE/Content/3080.html>*

Nowadays, an “Audio Frequency Analog Engineer” is any high-school kid with a PC and SoundBlaster Card

Their products:

- Mixers
- Equalizers
- Crossover networks
- Reverbs
- Fuzz Boxes

*Emulated on a PC or
programmable
DSP*

PLUS:

- Synthesizers and guitar amp modeling
- Time warp function that squeeze 20% off of a song’s play time *without altering the pitch.*
- Real-time pitch correction makes even Leonard Cohen sing on key

...try doing that with an op-amp!

The Other Super Collider

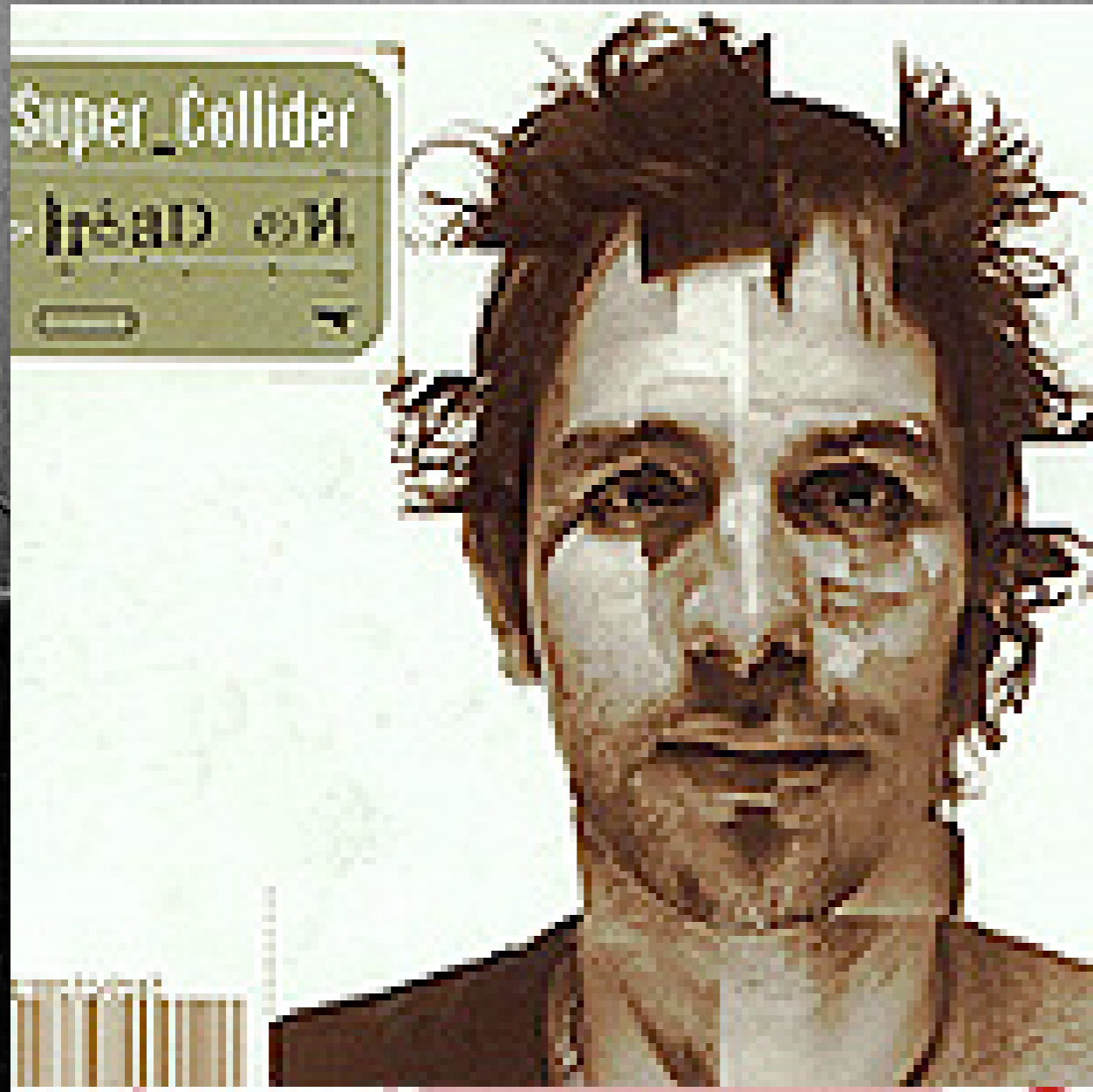

What Unemployed the Audio Analog Engineers?

- ADC/DAC Sampling Rates and Accuracies (192 kSa/s, >100dB SINAD) exceeded requirements
 - *Audio requirements set by human ear*
- Digital Processing capability exceeded requirements at reasonable cost
 - *PC's CPU executes 50,000 instructions per audio waveform sample*

Once Upon a Time, there was a job called: “Low-Level **Radio Frequency Analog Engineer**”

Their products:

- Mixers
- Equalizers
- Phase Shifters
- Down converters
- Phase-locked Loops

Fermilab's Booster Low-Level RF system - 2004

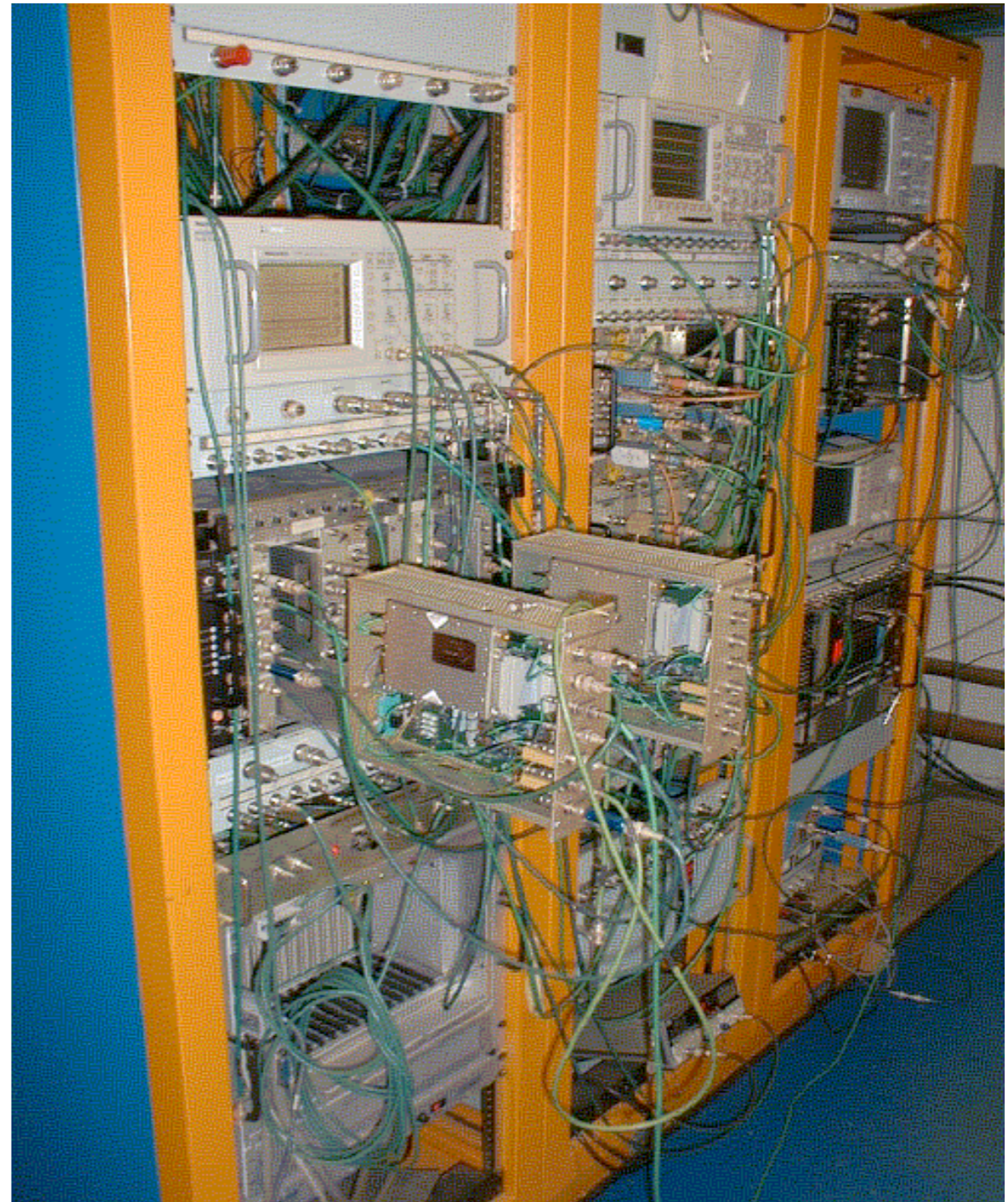

Nowadays, a “LLRF Analog Engineer” is *(or should be)* any old programmer with a fast digitizer and an FPGA

Their products:

- Mixers
- Equalizers
- Phase Shifters
- Down converters
- PLLs

*Implemented in
FPGA's*

PLUS:

- Direct Digital Synthesis of complex RF waveforms
- Built-in system diagnostics
- Digital Reproducibility (&spares!)
- High Speed Serial Links
- Multi-user support

What Unemploys the Analog RF Engineers?

- ADC Sampling Rates and Accuracies exceed requirements
 - ~ 4 samples per RF period gives bunch-by-bunch phase and amplitude
- Digital Processing capability exceeded requirements at reasonable cost
 - FPGAs and DSP's

For ~100 MHz or less: GAME OVER

Algorithm Independent Hardware for Accelerator Instrumentation & Control

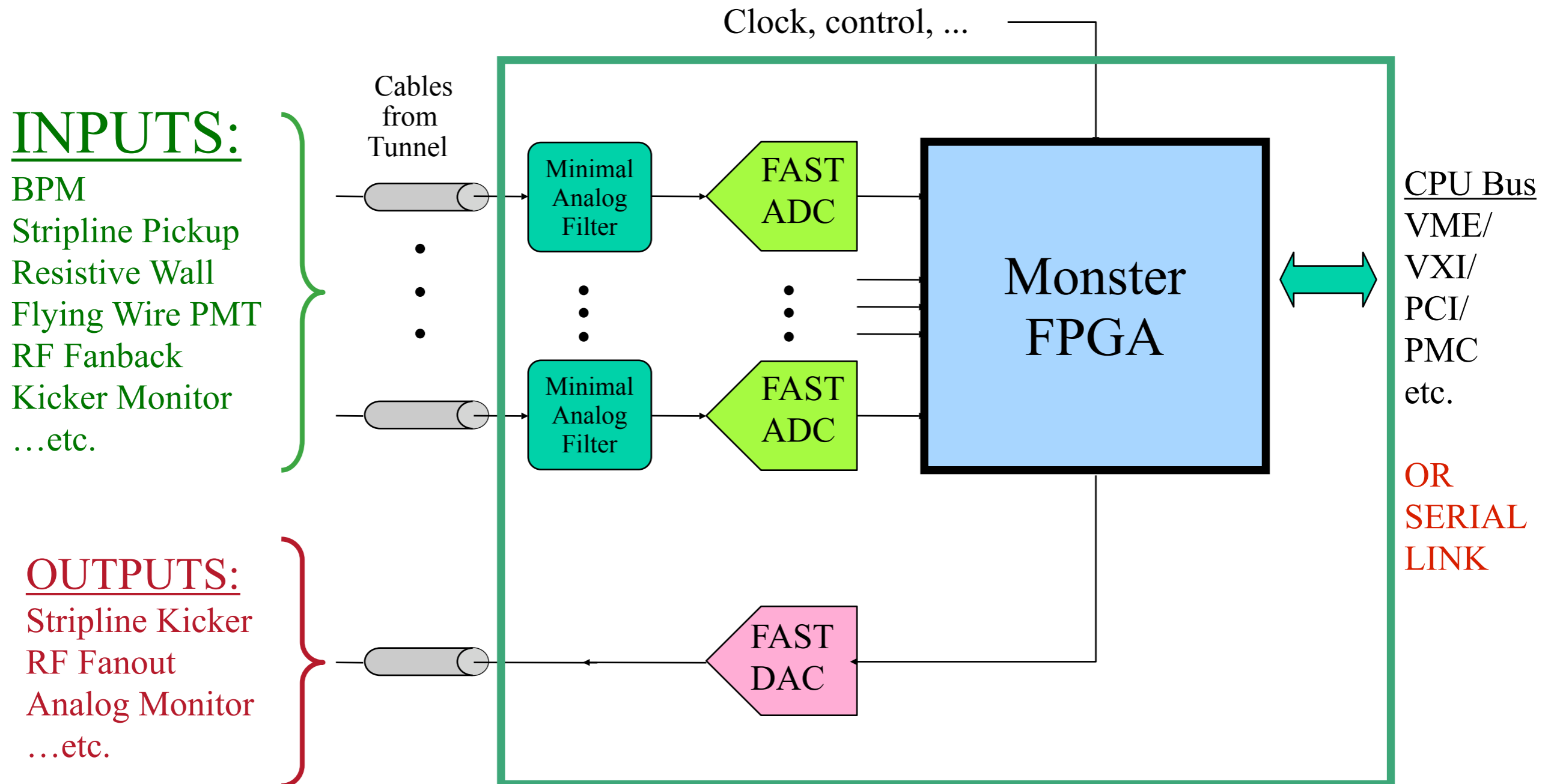

The Board

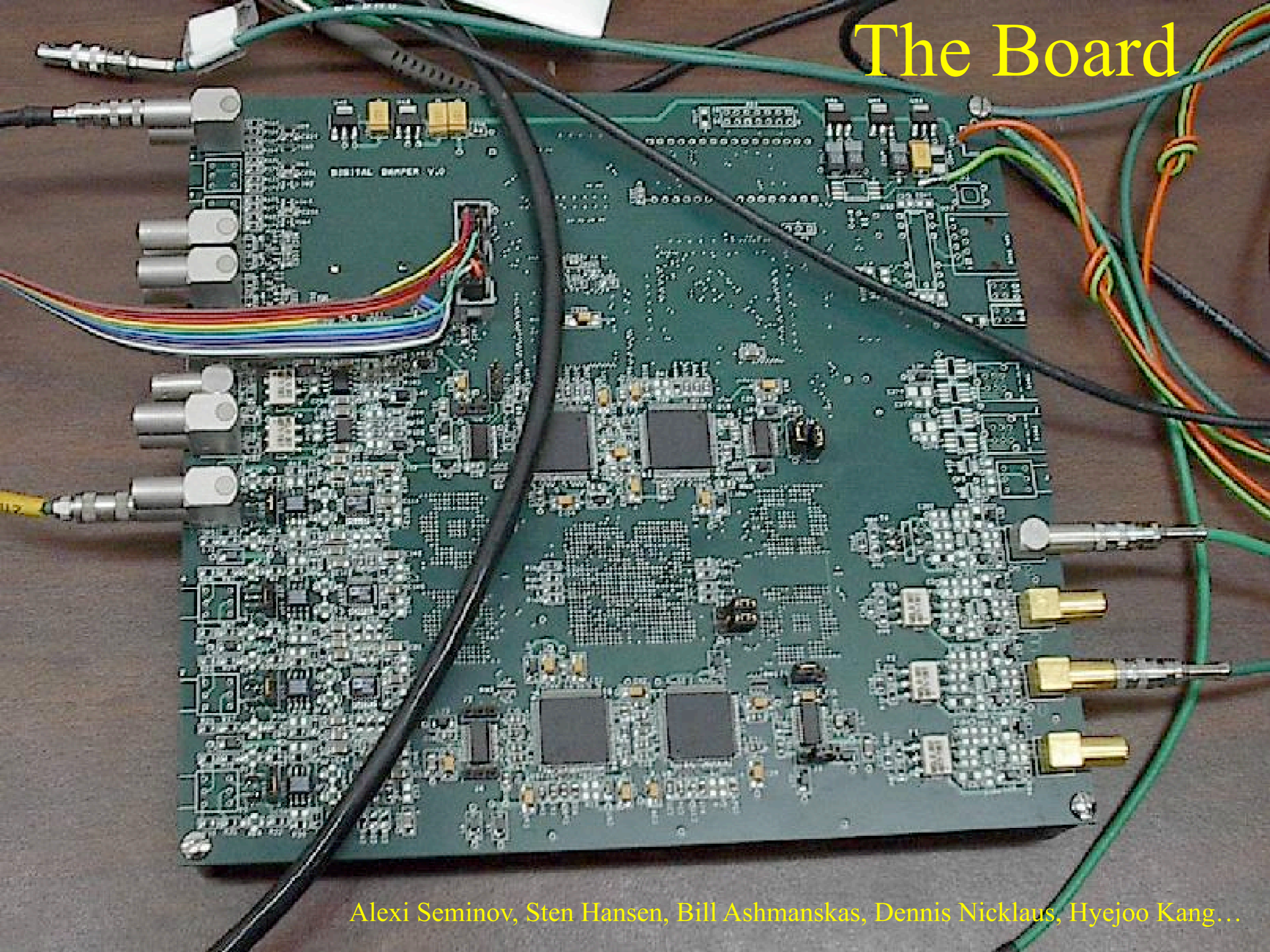

Alexi Seminov, Sten Hansen, Bill Ashmanskas, Dennis Nicklaus, Hyejoo Kang...

NAL Main Ring Dipole and Quad Supplies

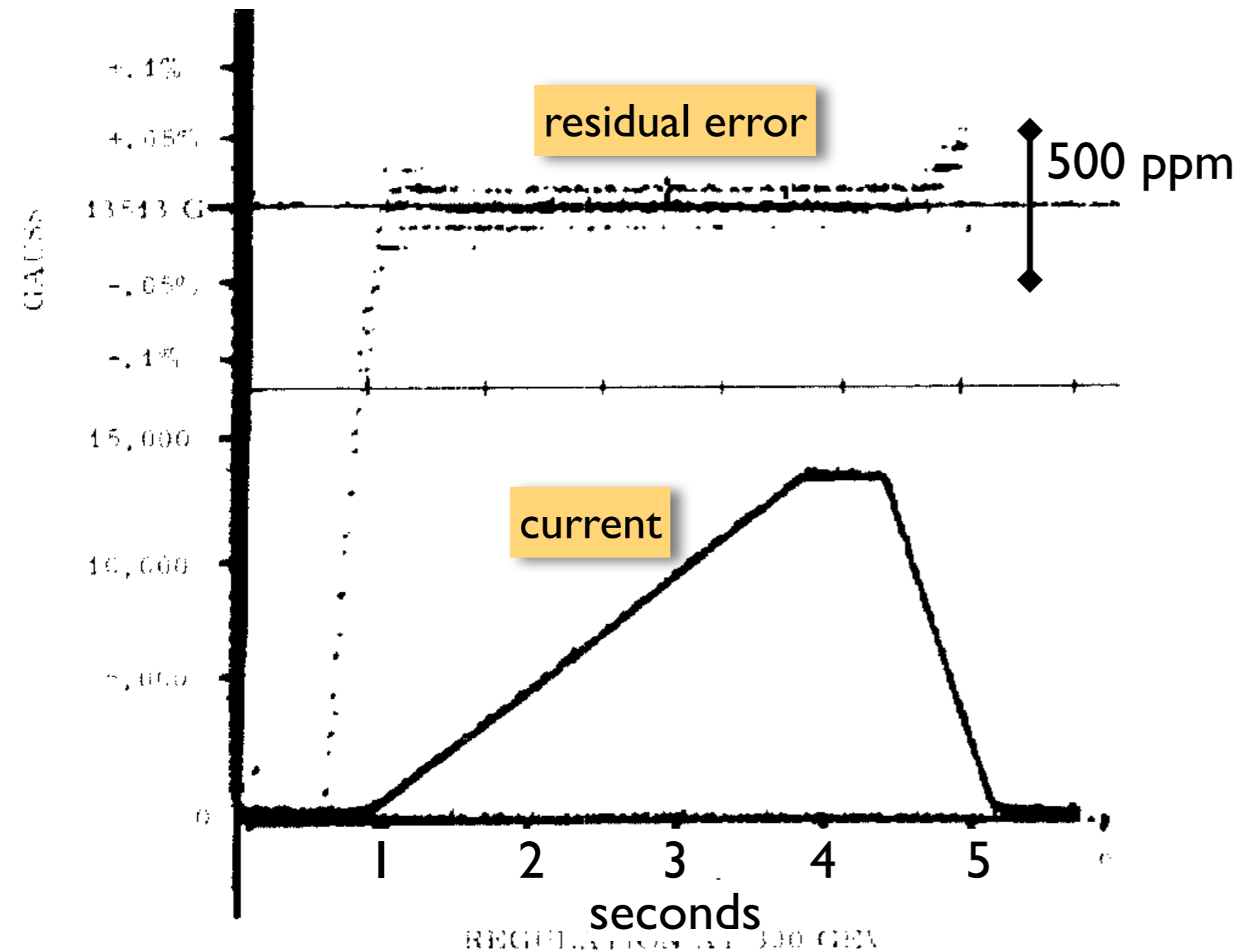

- Deployed in the early 70's
- MAC16 computer in regulation loop, 720 Hz sample rate
- Employed simple feedforward to achieve 1 LSB regulation during slow extraction (100 ppm)
- See Hermann's lecture for modern implementation and performance in LHC

Performance Challenges with Examples

- Energy
 - Large facilities: high channel counts
- Intensity
 - Beam loading
 - Loss minimization
 - Coherent instabilities
- Luminosity
 - Emittance/beam preservation
 - Interaction point control
- Brightness
 - Related to stability
- Operational Improvements
 - Machine protection
 - Subsystem enhancements

Energy

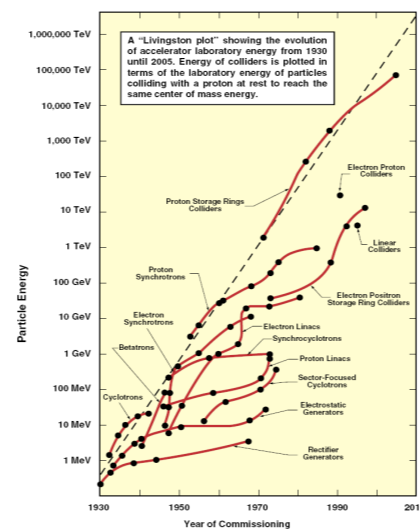

ILC RF Scale

To reach 500 GeV c.m. energy with linacs:

- 16,088 SC Cavities: 9 cell, 1.3 GHz
- 1848 CryoModules(LHC 1232 dipole cryounits)
- > 600 RF Units (#CM/3) supported by LLRF units:
 - each with about 95 ADCs, 6 DACs
 - 0.07% amplitude, 0.35% phase regulation in main linac to achieve energy stability of 0.1%

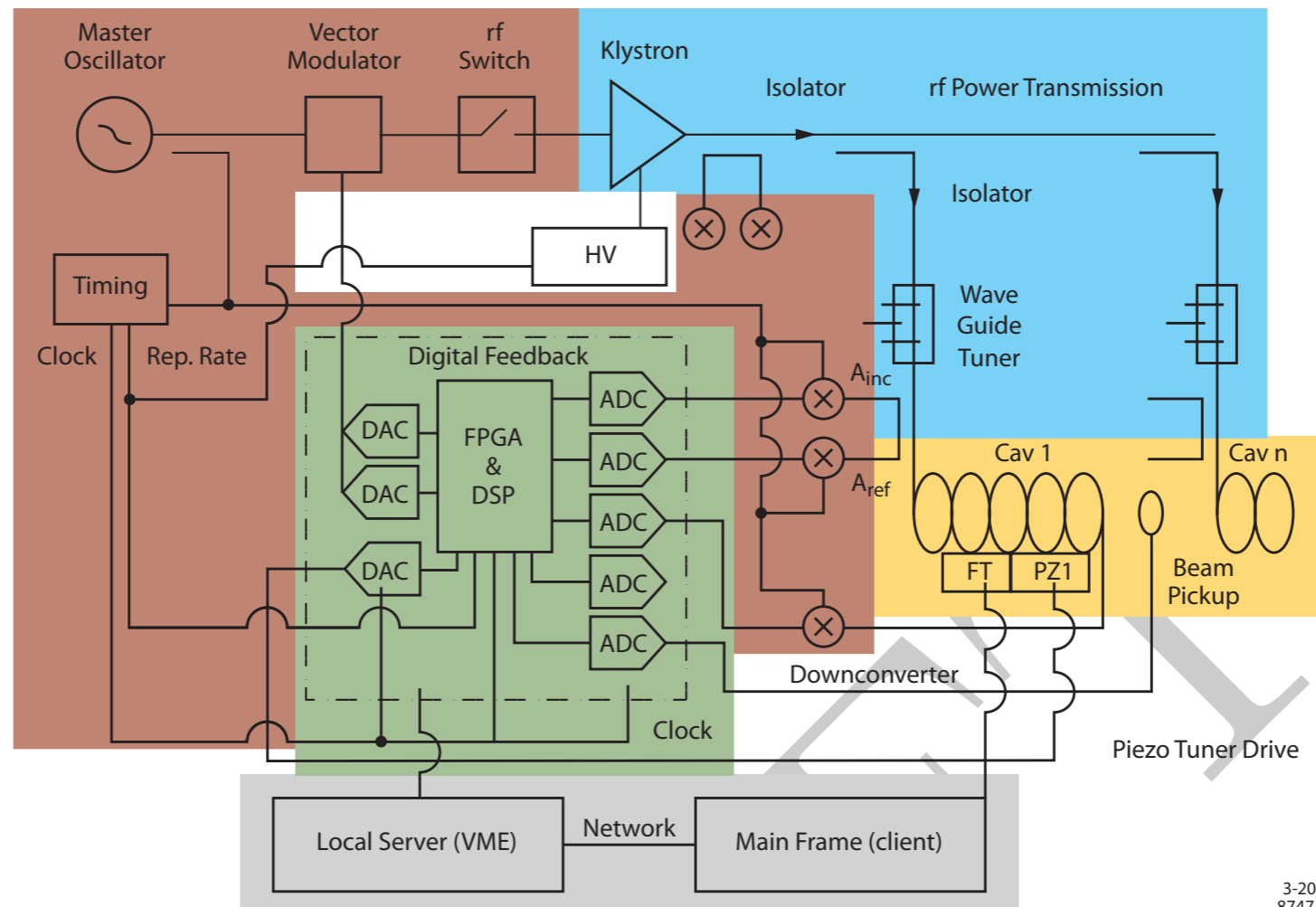

Large Scale BPM Production

- about 800 units manufactured
- Required: affordability, built in test, remotely configurable
- Integrated, single board design
- 1990's low cost design:
 - 78 kHz turn by turn sampling (audio)
 - fixed point DSP
 - Firewire serial

RHIC electronics

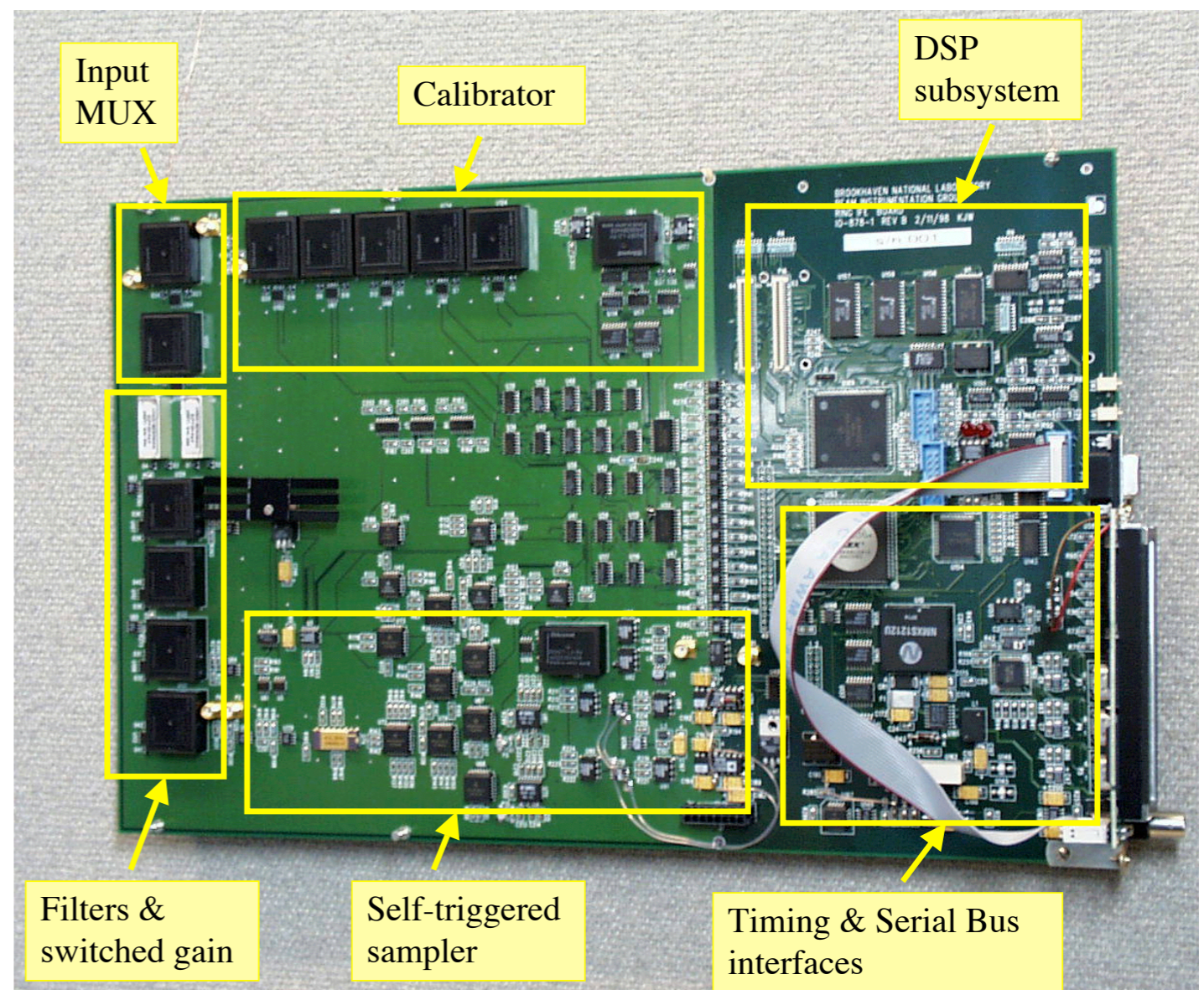

Intensity

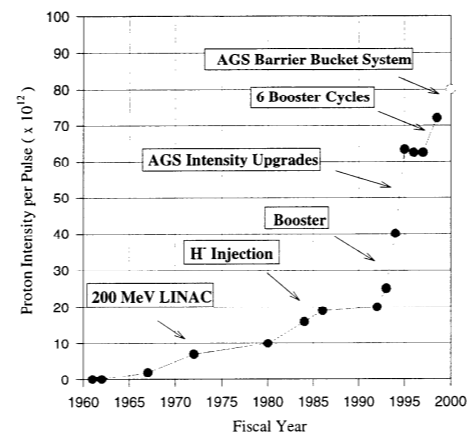

SNS Goals

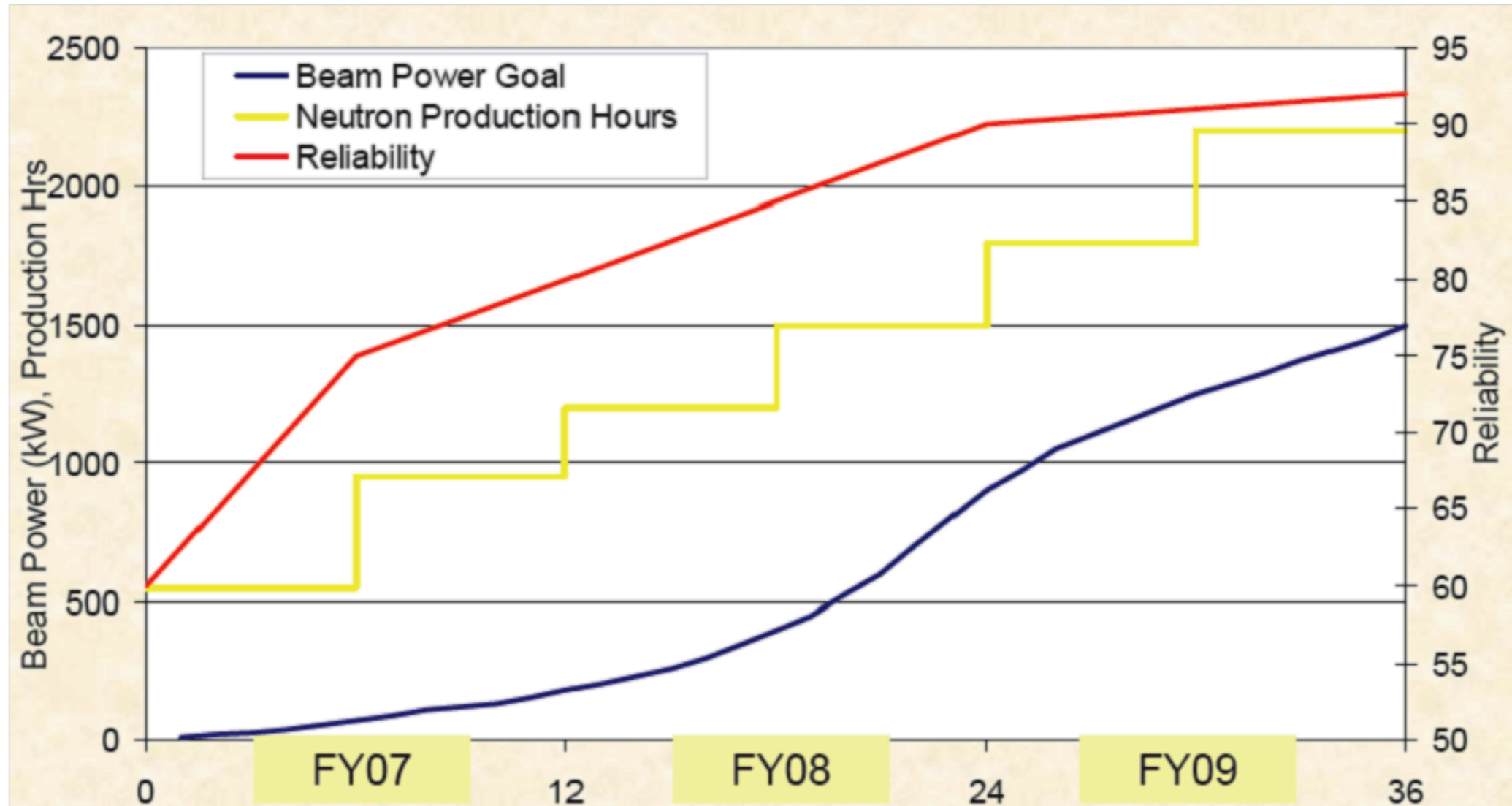

- MW operation requires 1 ms pulse length in linac, at 60 Hz, 10^{14} protons per pulse, 1 GeV output, with only 1 Watt per meter loss.
- Consistent linac LLRF regulation goal: 0.5% amplitude, 0.5 degrees phase (402.5 and 805 MHz)

Linac RF Components

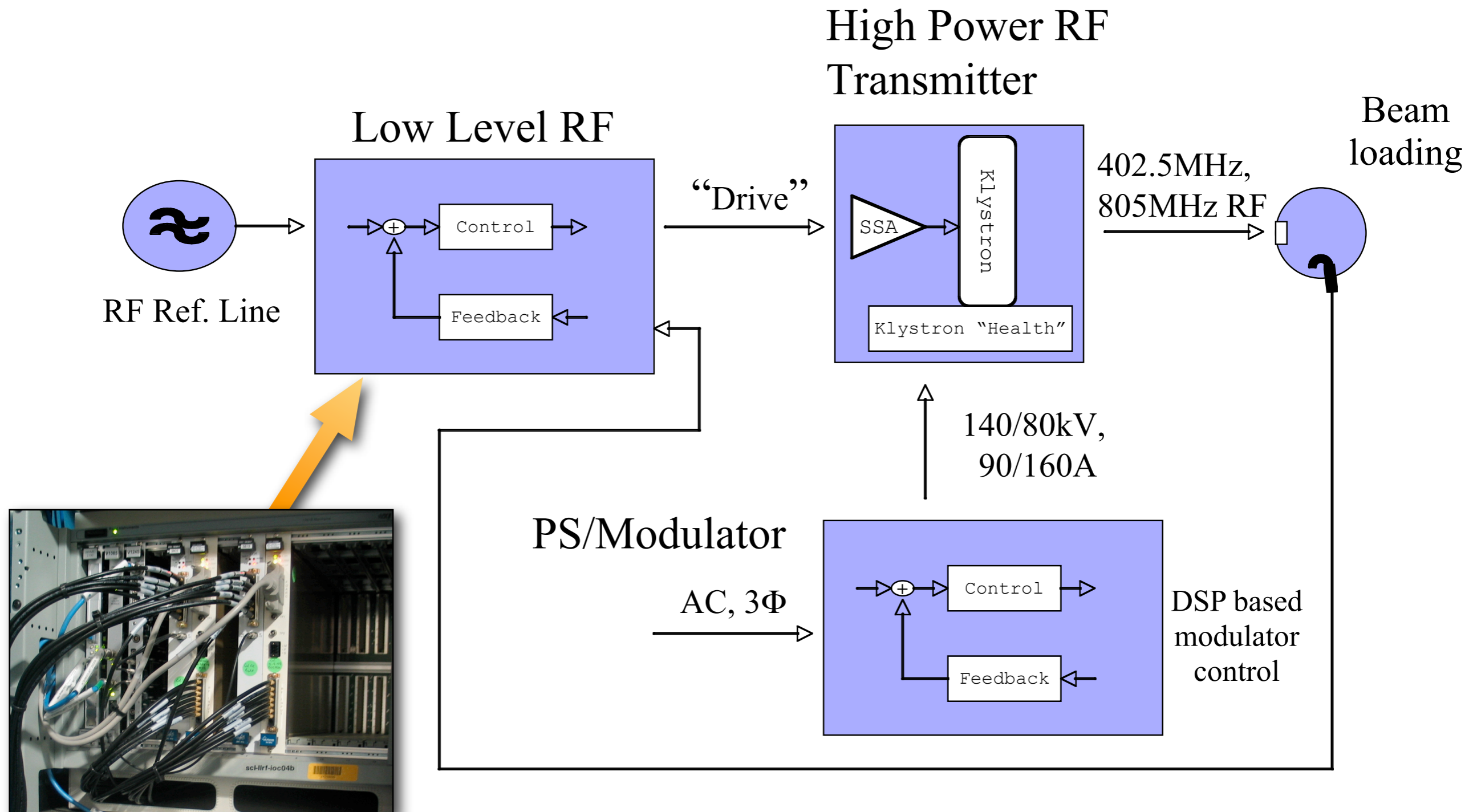

See LLRF lecture for general beam loading analysis and implementation details

Phase Distribution Along Pulse

Early try

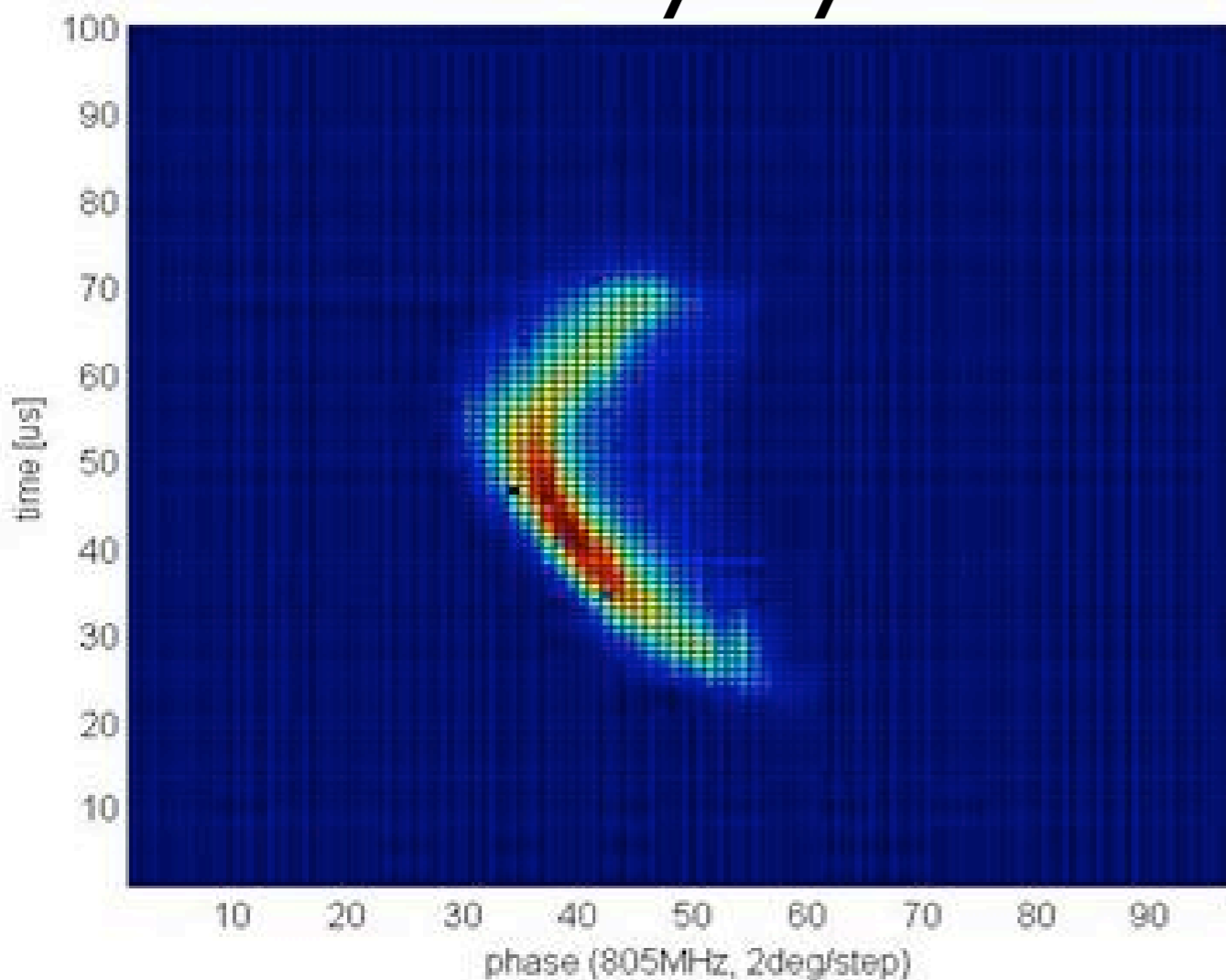

Optimized
Feedback + Feedforward

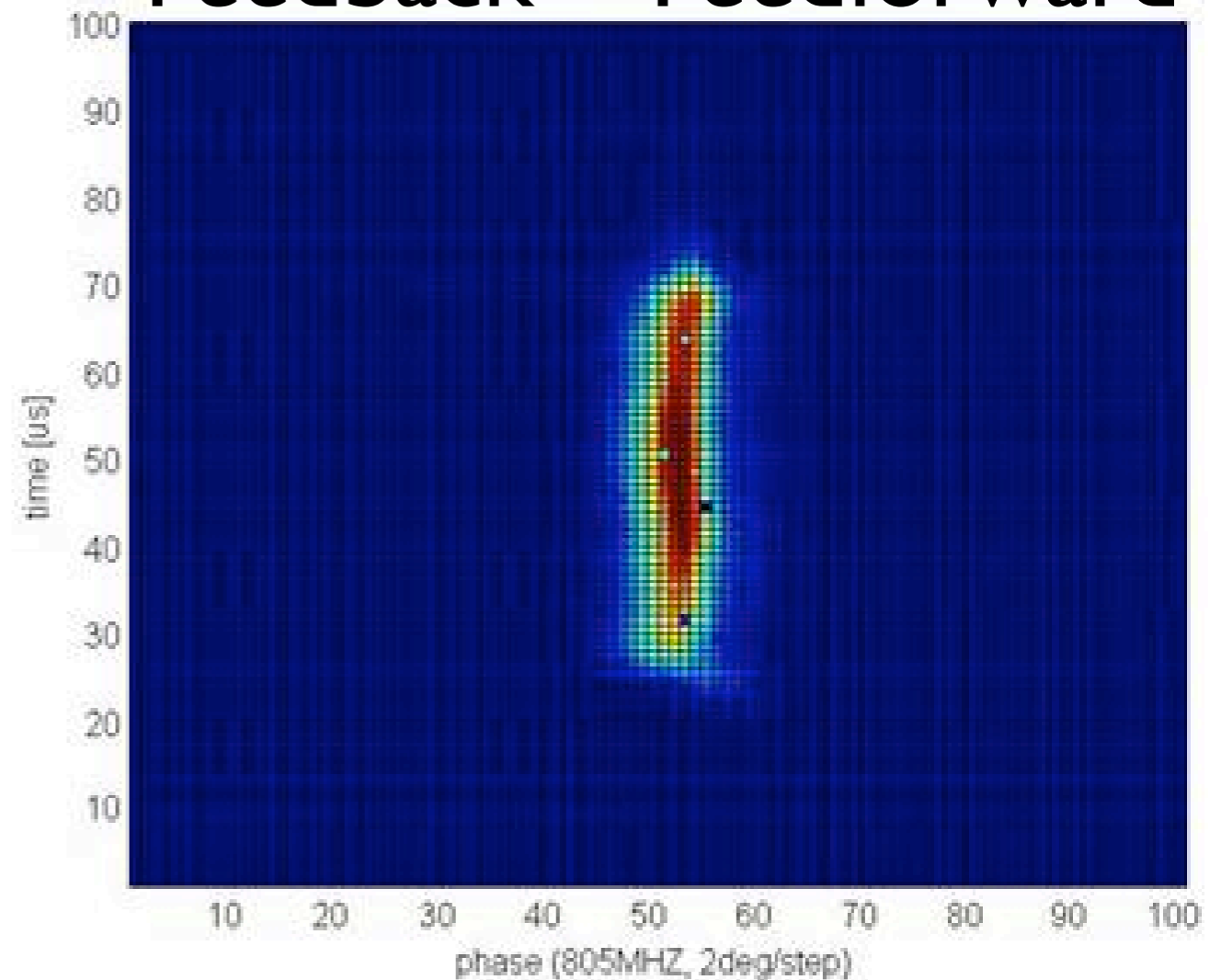

Off momentum particles could be lost and activate machine downstream

Tuning for Low Loss

To allow hands-on maintenance:
< 1 Watt/meter beam loss

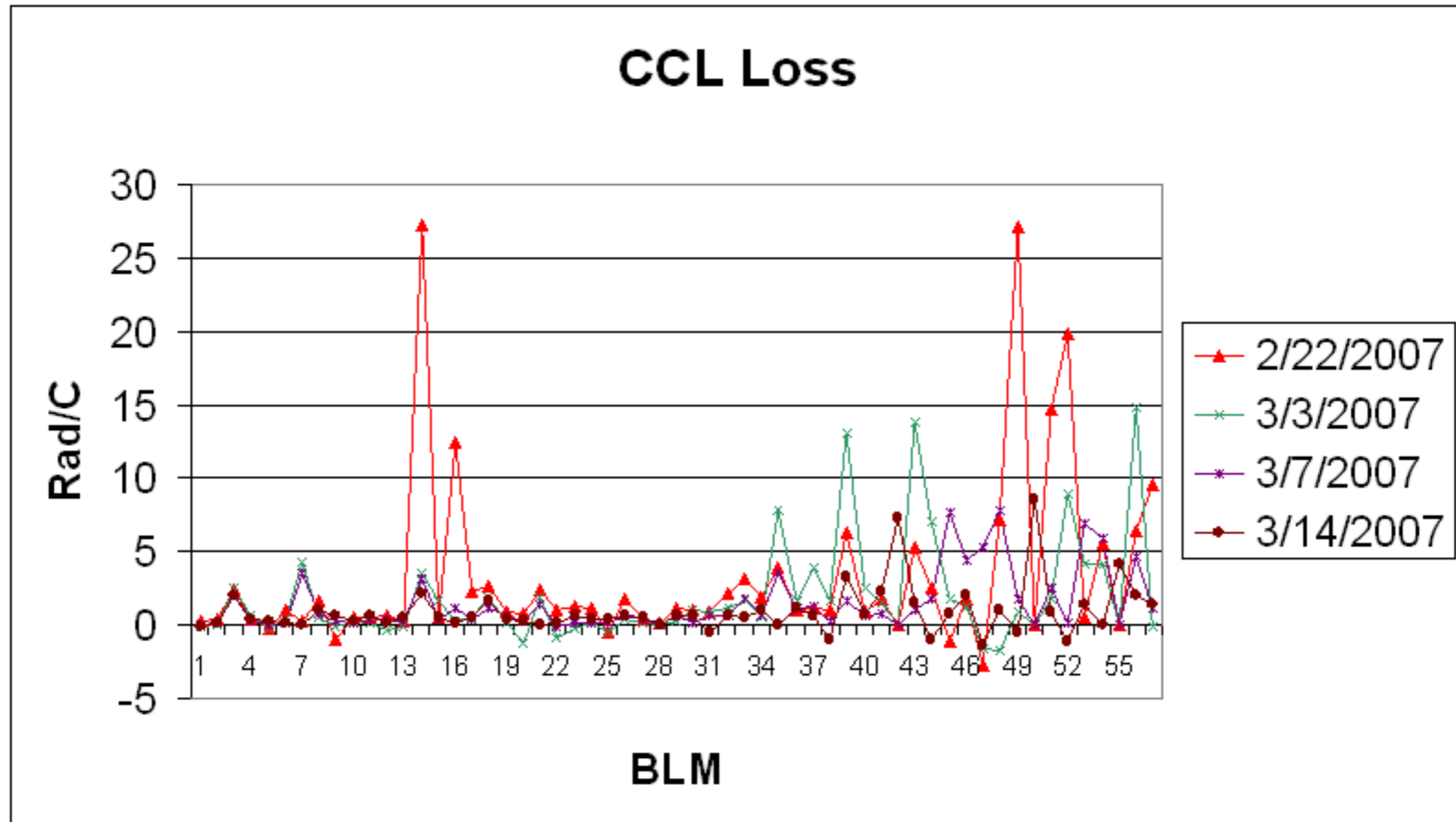

Digital control (particularly LLRF) is critical for rapid startup and achieving a low loss beam run

Instabilities

- Residual Gas
 - (-) e-p instability in hadron rings
 - (+) fast ion instability in electron rings
 - Countermeasures: good vacuum, clearing gap, solenoids, **active feedback**, ...
- Wall impedance
 - Resistive wall
 - Broadband inductive
 - Cavity modes
 - Countermeasures: shielded components (bellows, ports,...), HOM couplers, **active feedback**, ...

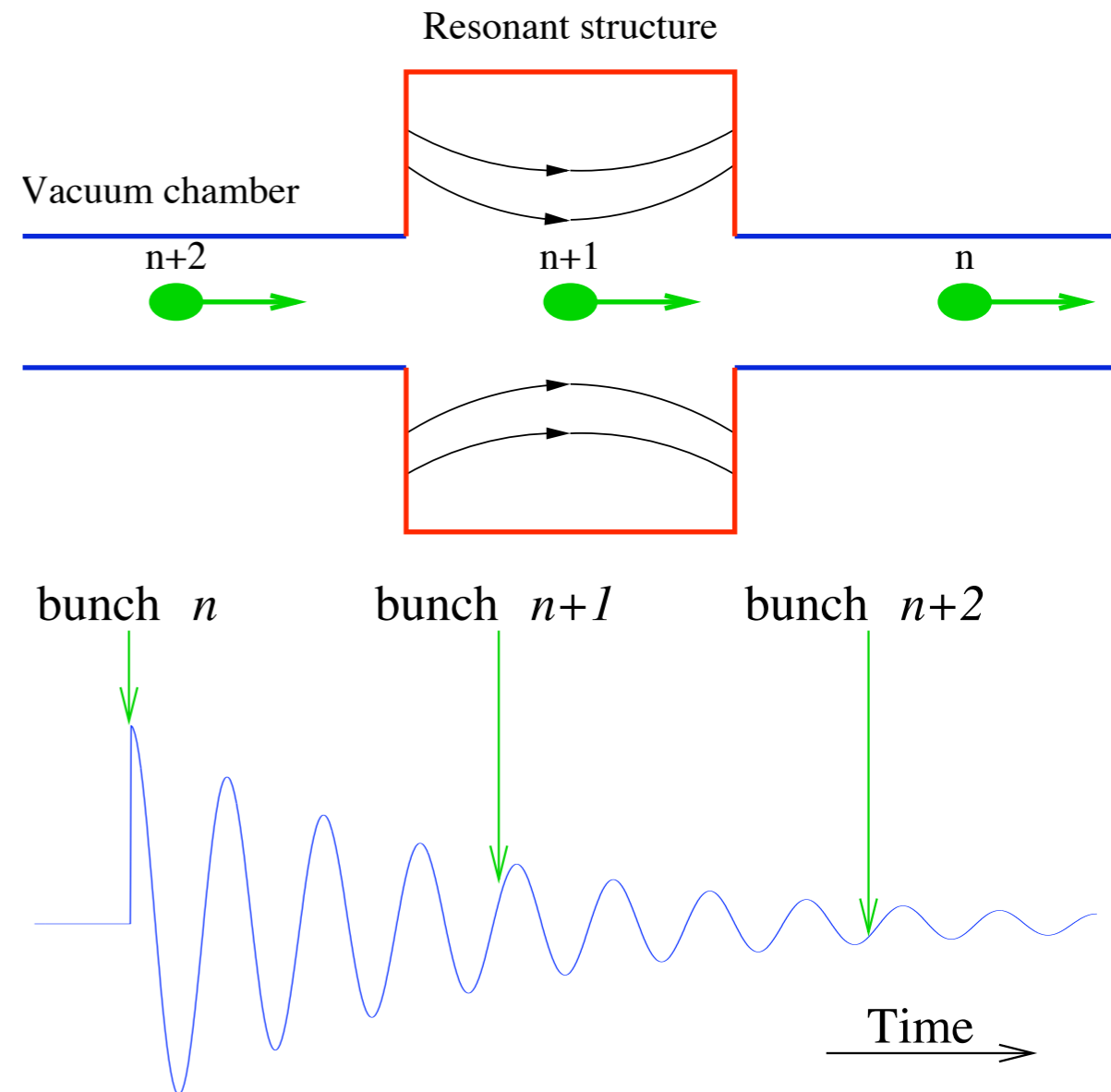

More on this during feedback lecture

Digital Feedback Systems

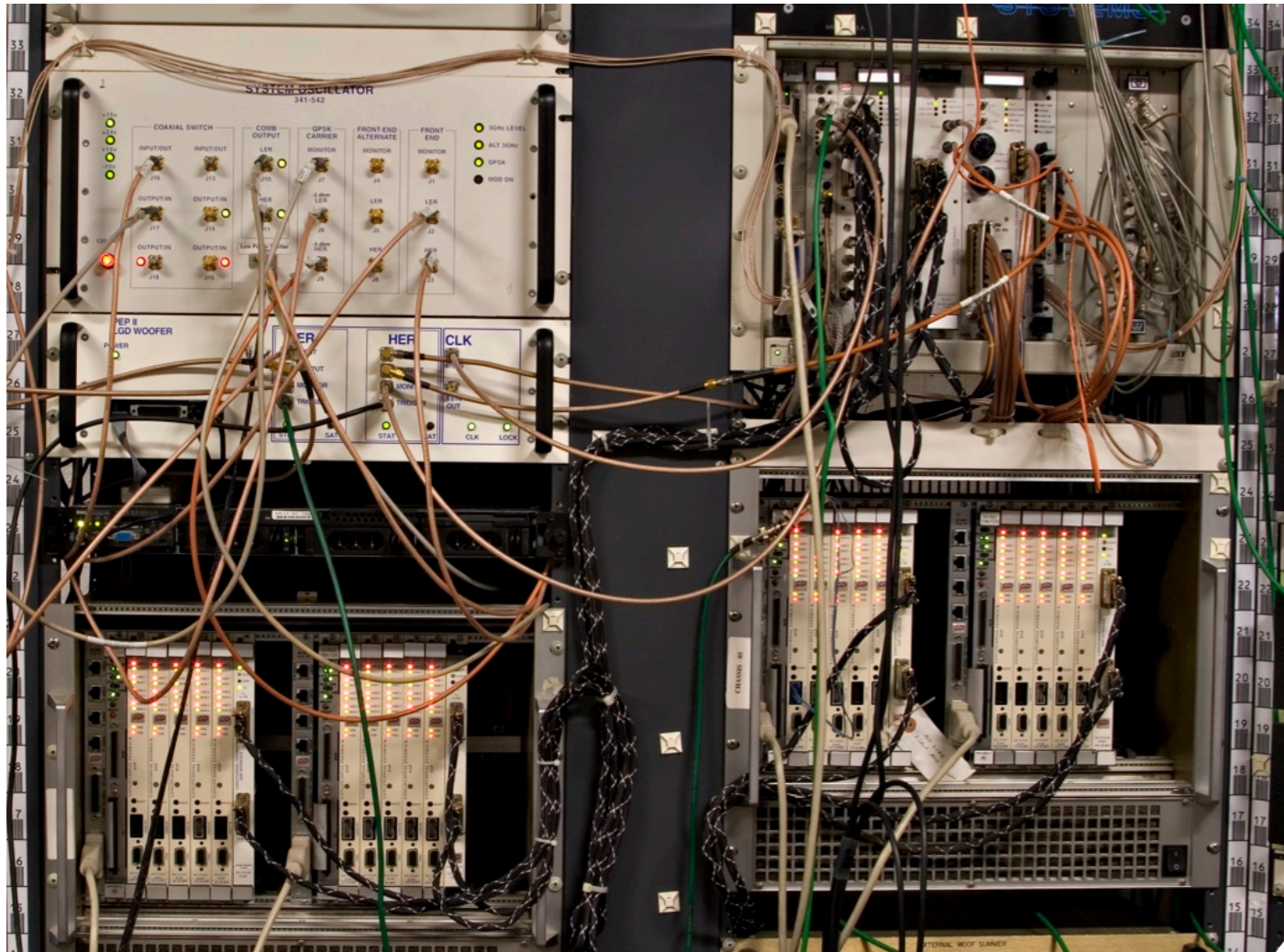

1990s

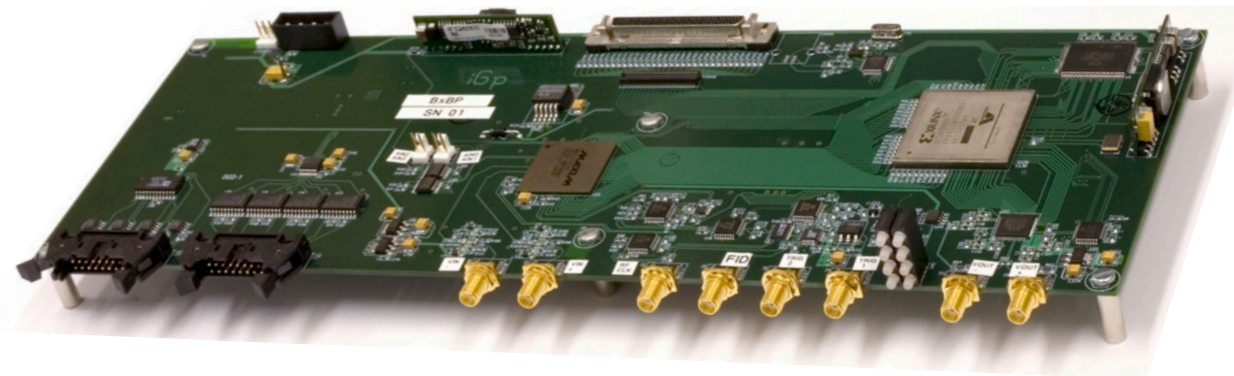

2000s

Grow then Damp

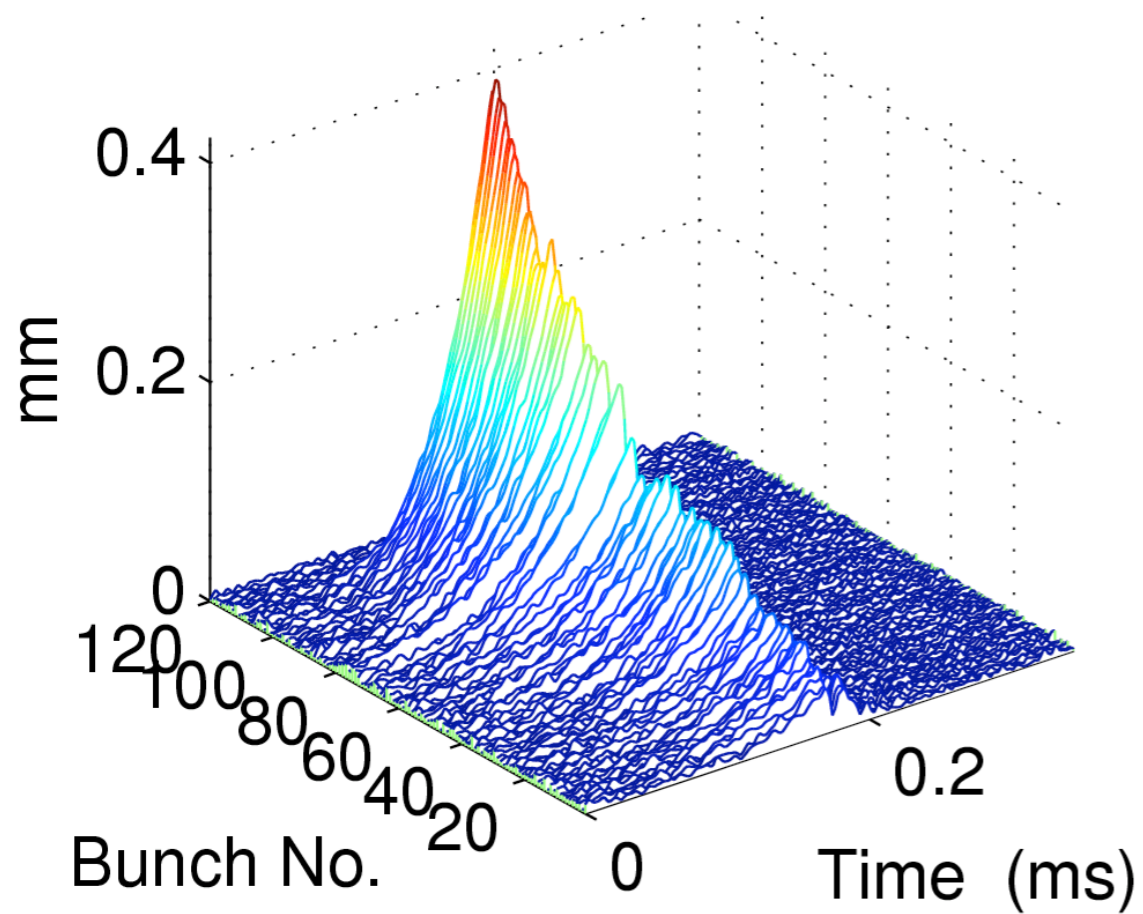

Horizontal grow/damp in
DAΦNE - resistive wall

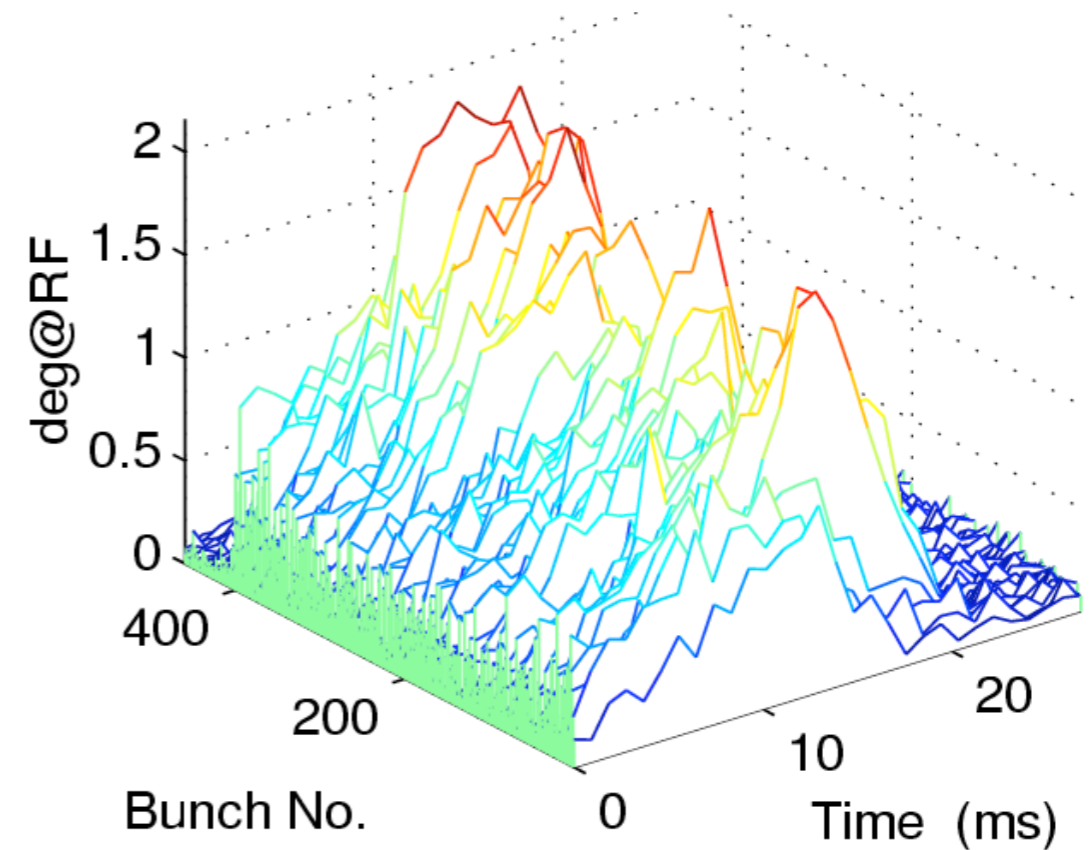

Longitudinal grow/damp in PLS
- cavity HOMs

AGS Resistive Wall Instability

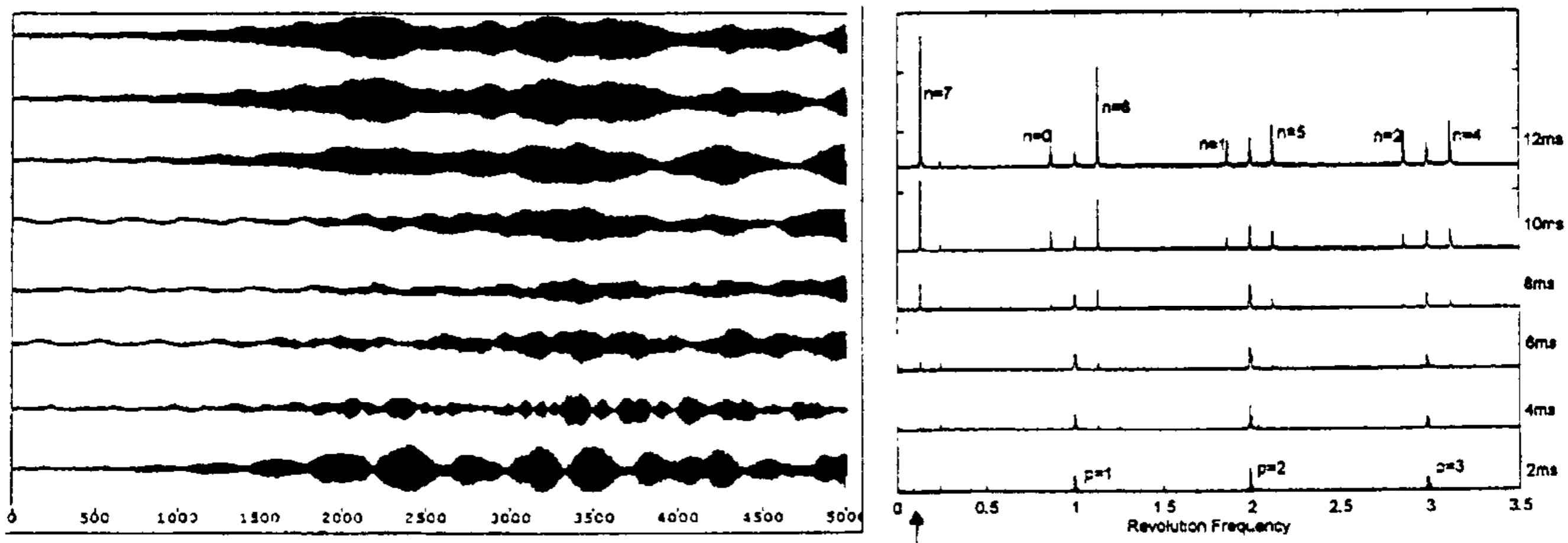
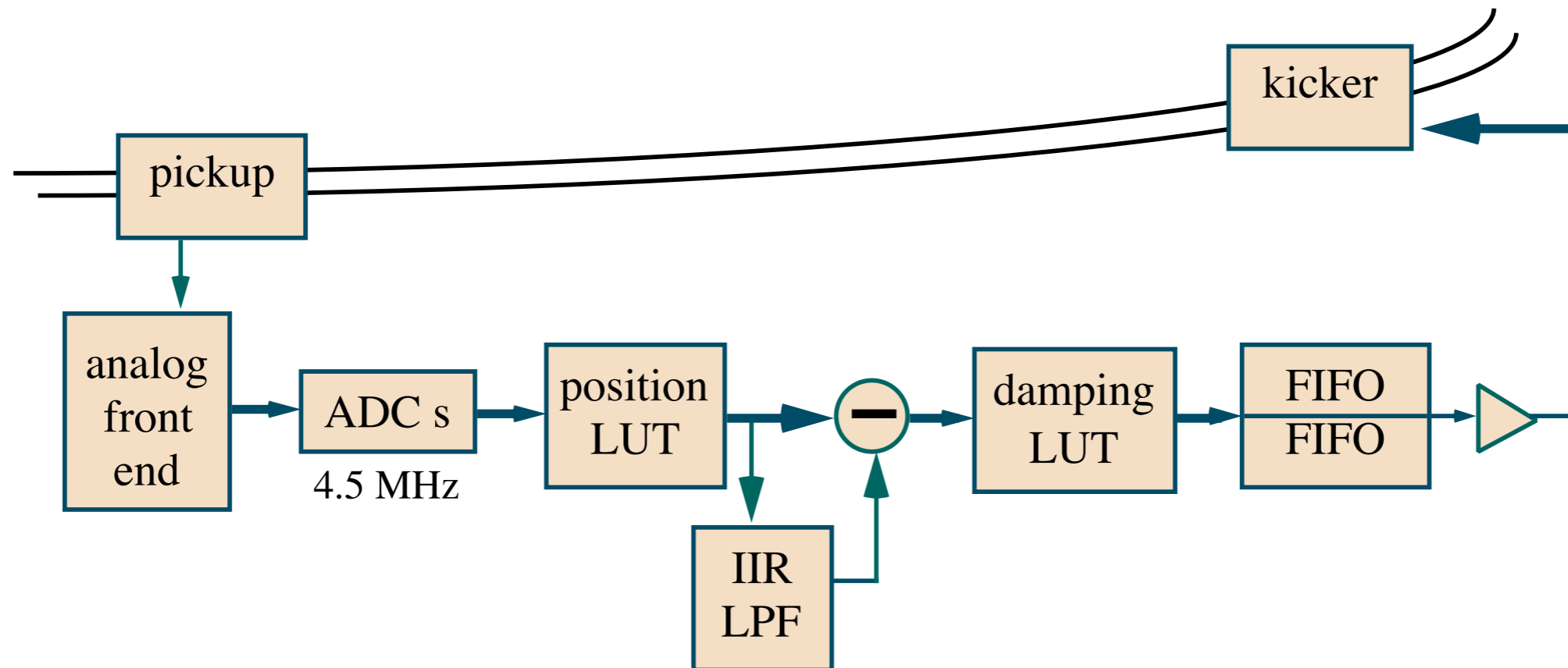

FIGURE 3. The left figure shows the growth of a vertical coupled bunch instability at AGS injection energy of 1.5 GeV for the eight bunches. The horizontal scale is in turns. The right graph shows the evolution of the frequency components during the growth of the instability.

AGS Transverse Feedback



- Digital filter implemented in PLD
- Simple implementation, dramatic results
- Record intensities well beyond transverse instability threshold

Increasing intensity

AGS Proton Intensity History

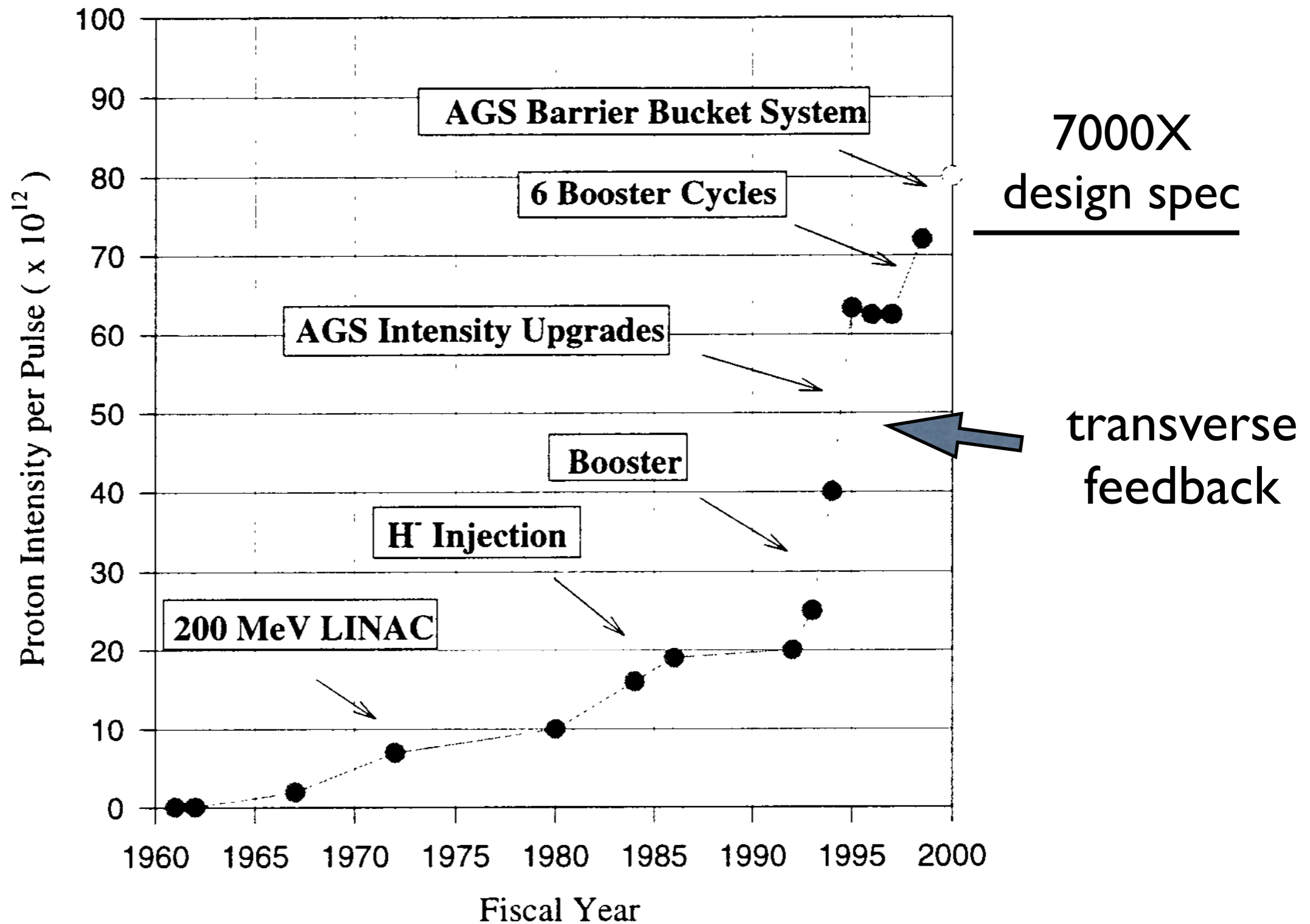

Luminosity

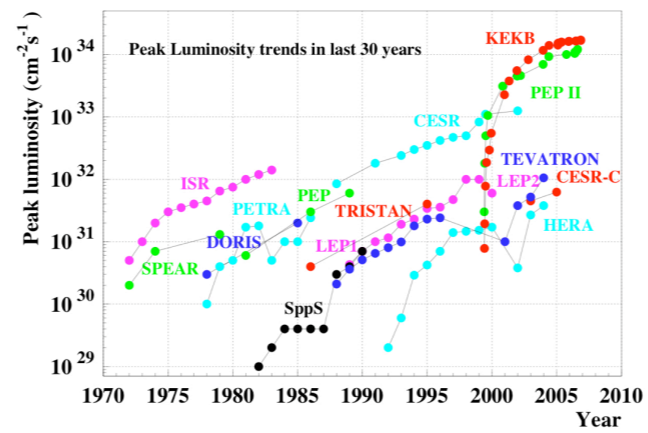

Experimenter's View of Performance: Integrated Luminosity

RHIC Delivered Au-Au Luminosity

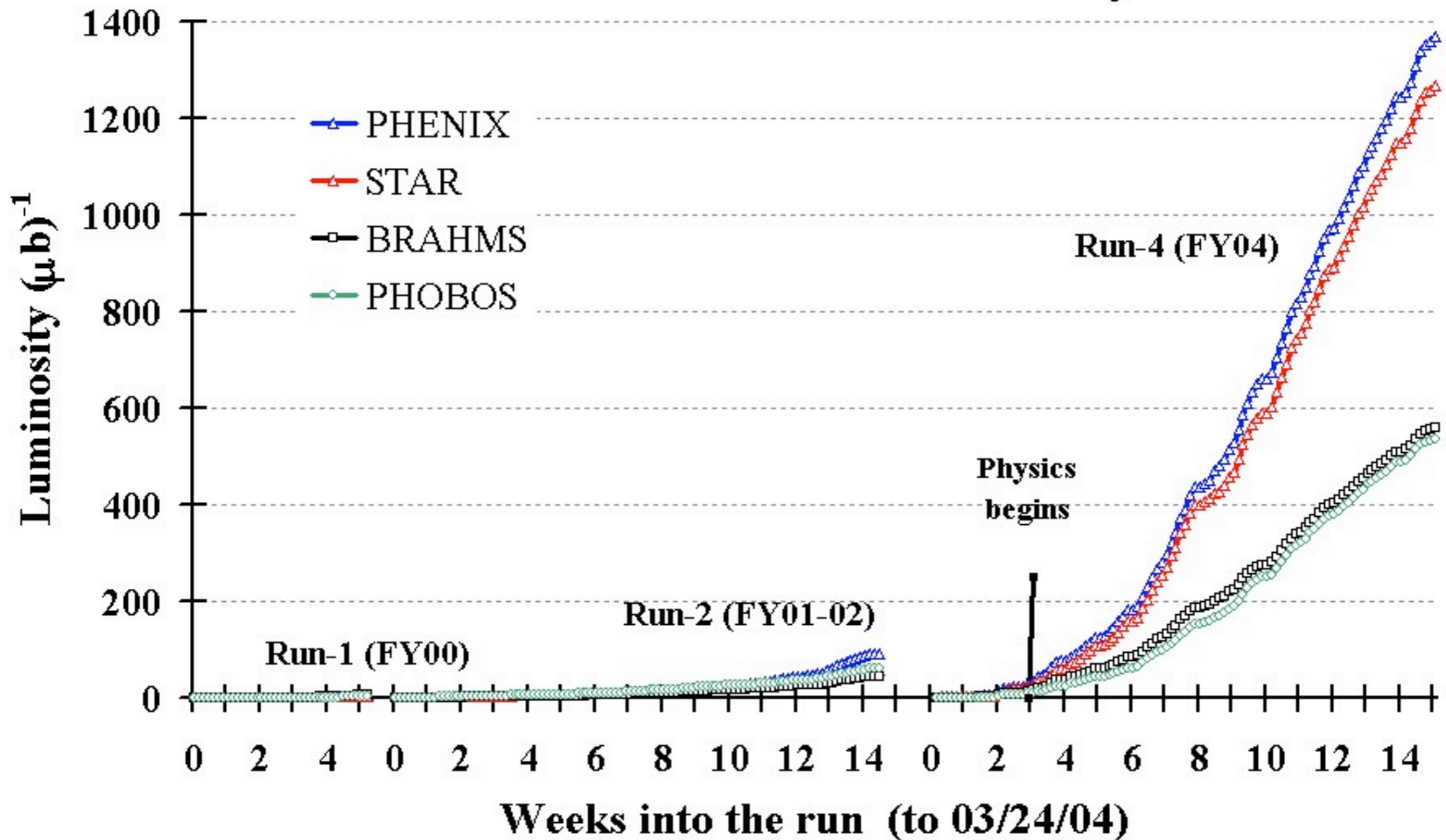

RHIC Run 6 Tune Chromaticity and Coupling Feedback

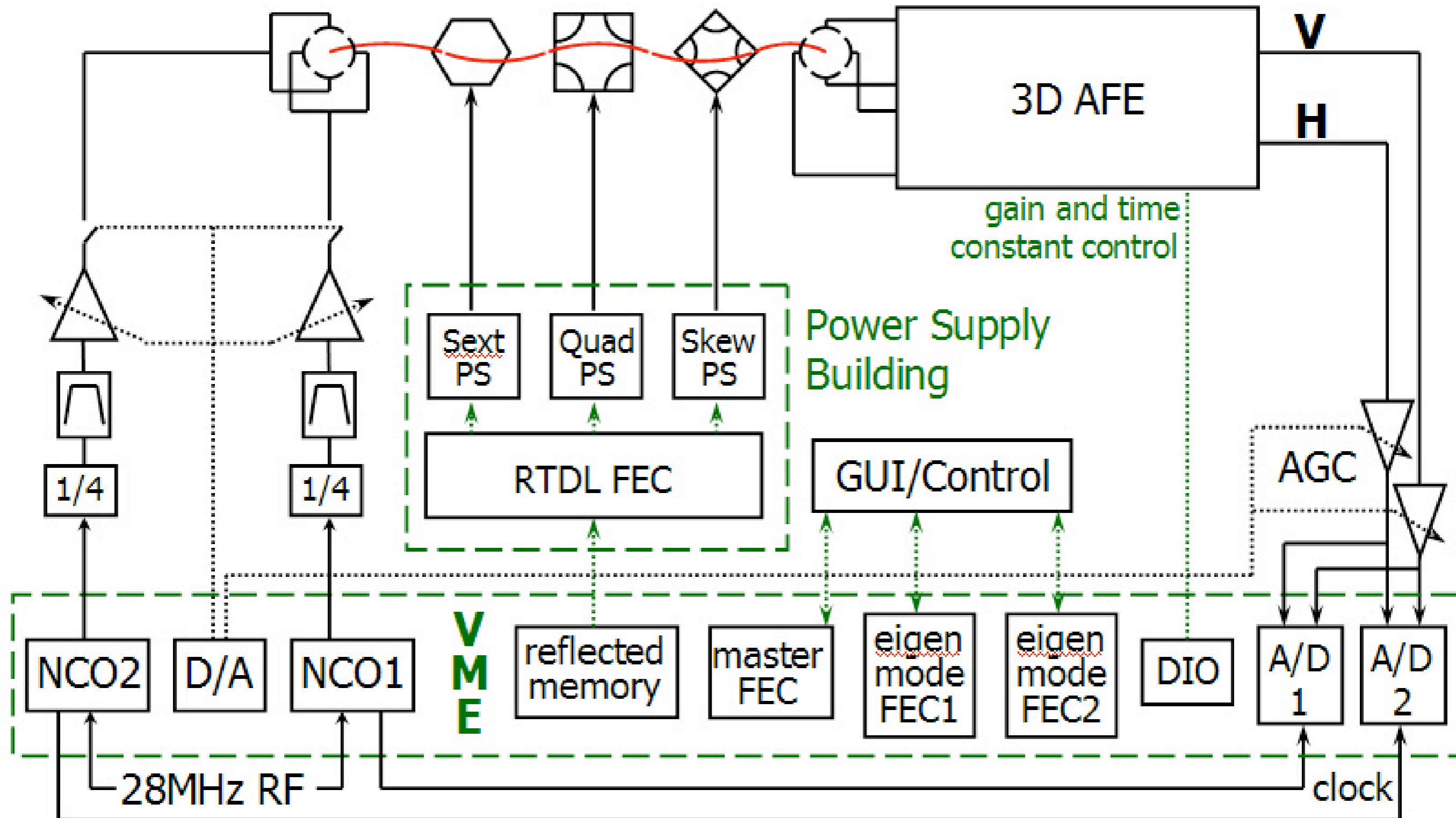

Results of Ramps with Feedback

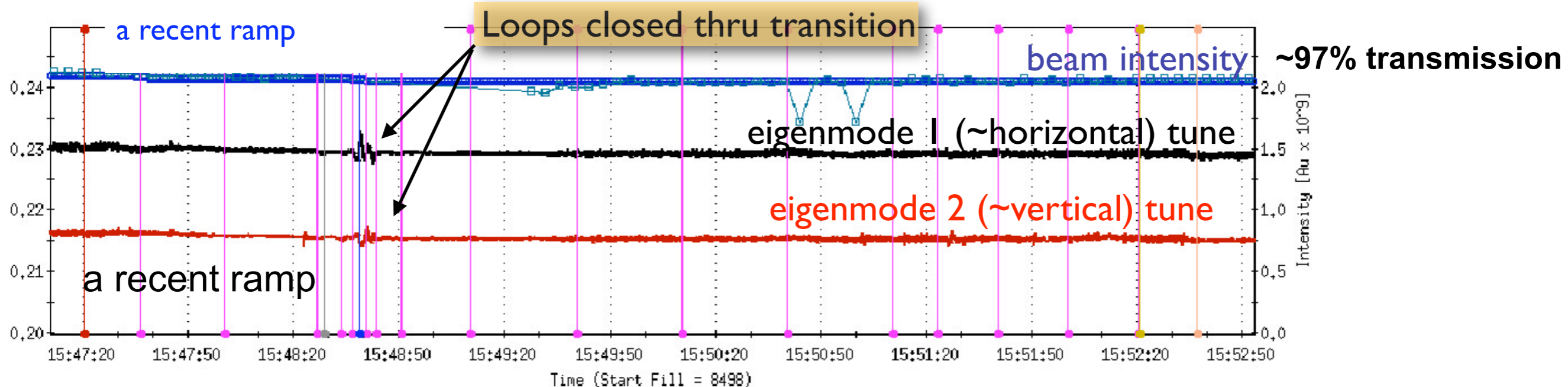
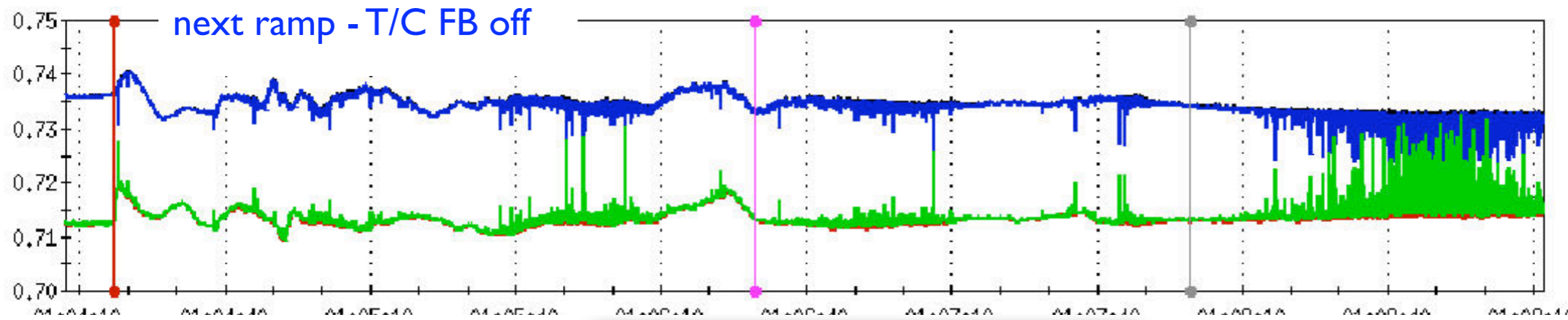
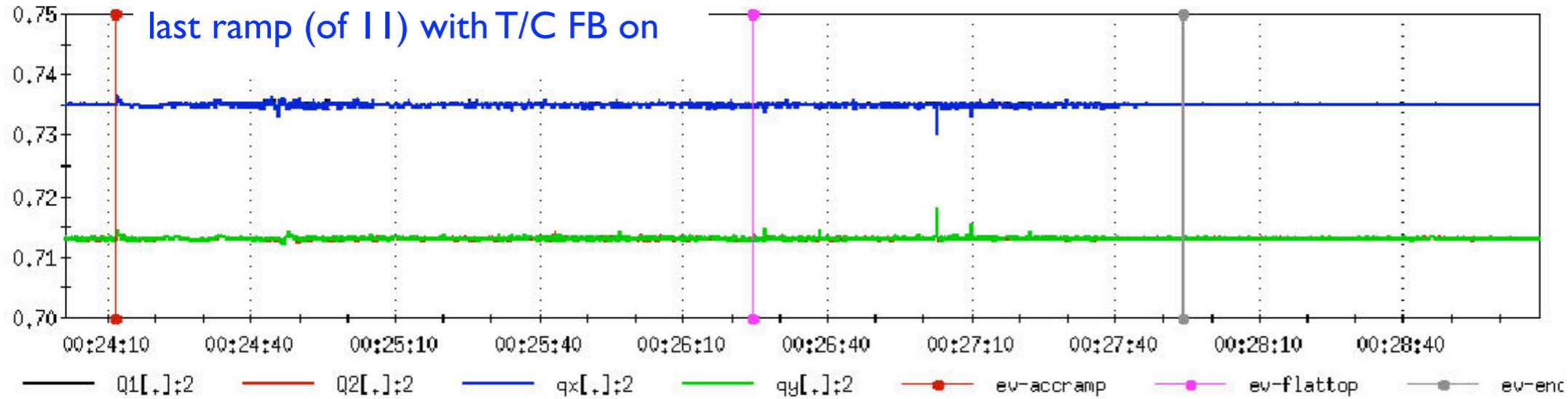

ILC Intra-train Feedback

- RMS vertical beam size at IP is 5.7 nm, so nm offsets will noticeably reduce luminosity
- Control offsets to nm level by measuring result of strong beam-beam kick and feeding back to incoming beam
- Performance issue: latency

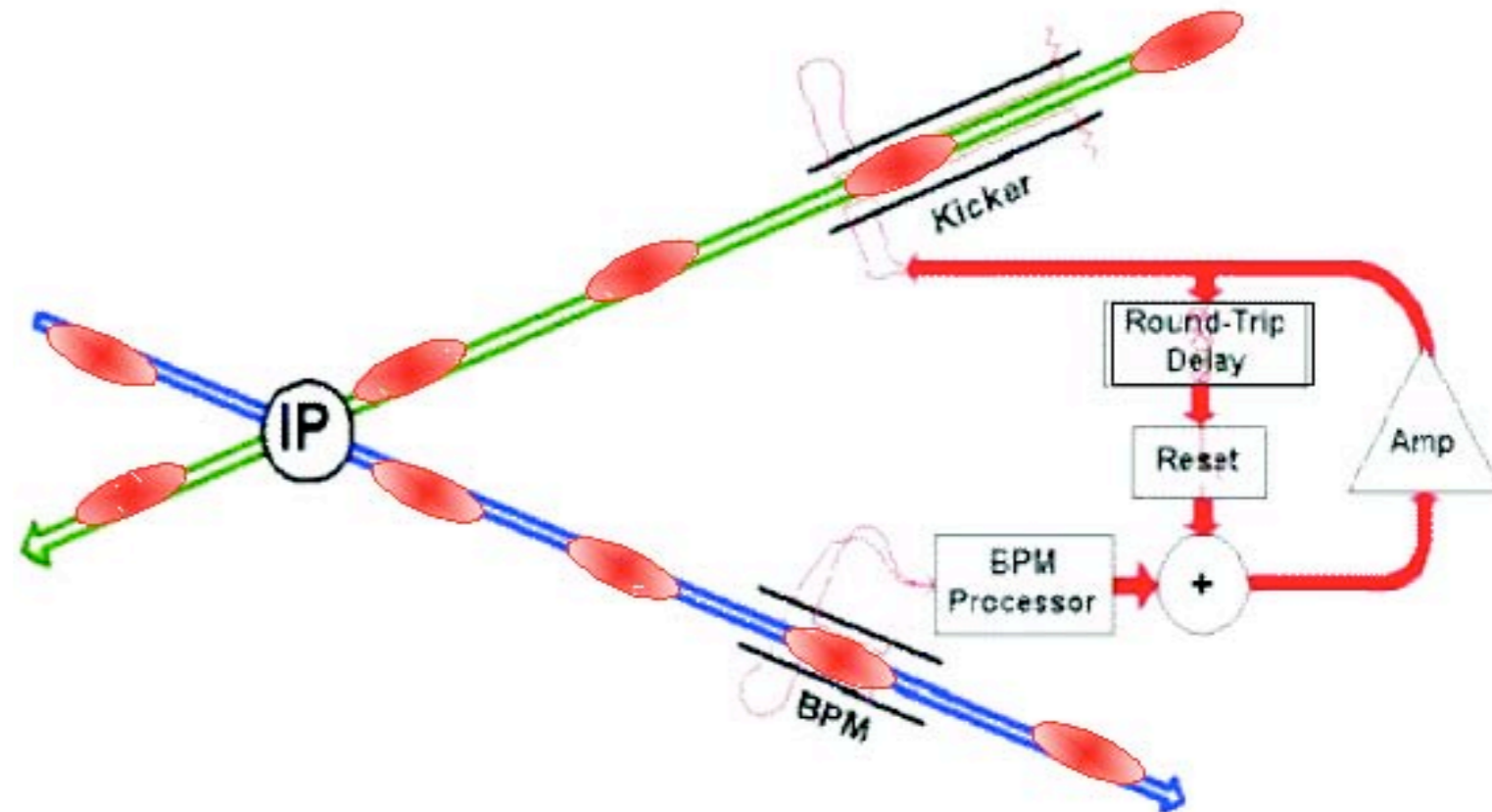

Source of delay	Contribution to latency (ns)
Beam time-of-flight	7
Signal return time	15
BPM processor	7
ADC/DAC	40
FPGA processing	25
I/O	3
Amplifier risetime	40
Kicker fill time	3
Total	140

Brightness

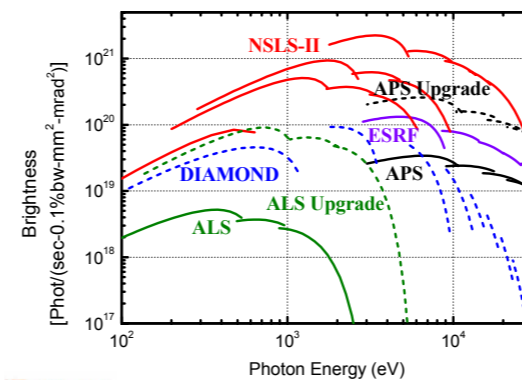

To Utilize Brightness, Users Need Stability

SPEAR

experiment parameters	beam orbit	beam size	beam energy/ energy spread
< 0.1% intensity steering to small samples	$\Delta x,y < 5\% \sigma_{x,y}$ $\Delta x',y' < 5\% \sigma'_{x,y}$	$\Delta \sigma_{x,y} < 0.1\% \sigma_{x,y}$ $\Delta \sigma'_{x,y} < 0.1\% \sigma'_{x,y}$	$\Delta E/E(\text{coher}) < 10^{-4}$ $\Delta E/E(\text{rms}) < 10^{-4}$
< 10^{-4} photon energy resolution	$\Delta x' < \sim 5 \mu\text{rad}$ $\Delta y' < \sim 1 \mu\text{rad}$ (undulator)		$\Delta E/E(\text{coher}) < 5 \times 10^{-5}$ $\Delta E/E(\text{rms}) < 10^{-4}$ (und n = 7)
timing, bunch length		$\Delta \sigma_t < 0.1\% \sigma_t$	$\Delta E/E(\text{coher}) < 10^{-4}$

- Stability requirements for small beams may be relaxed if beam size at experiment is limited by beam line optics (e.g. mirror slope error, point-spread function, etc.)
- Stability requirements depend on time interval

Time Scales

- **Disturbance time scale \ll experiment integration time:**

Orbit disturbances blow up effective beam σ and σ' , reduce intensity at experiment, but do not add noise

For $\Delta\varepsilon/\varepsilon = \varepsilon_{cm}/\varepsilon_o < \sim 10\%$: $\Delta y_{cm}(rms) < \sim 0.3 \sigma_y$ $\Delta y'_{cm}(rms) < \sim 0.3 \sigma_y$

Note: can have frequency aliasing if don't obey Nyquist....

- **Disturbance periods \geq experiment integration time:**

Orbit disturbances add noise to experiment

For $\Delta\varepsilon/\varepsilon = \sim 2\sqrt{\varepsilon_{cm}/\varepsilon_o} < \sim 10\%$: $\Delta y_{cm}(rms) < 0.05 \sigma_y$ $\Delta y'_{cm}(rms) < 0.05 \sigma_y$

- **Disturbance periods \gg experiment time (day(s) or more):**

Realigning experiment apparatus is a possibility

- **Sudden beam jumps or spikes can be bad even if rms remains low**

Peak amplitudes can be **> x5** rms level

- **Most demanding stability requirements:**

Orbit disturbance frequencies approximately bounded at high end by data sampling rate and a low end by data integration and scan times

\Rightarrow noise not filtered out

NSLS II Proposed Dipole Supply Parameters

- Each main dipole magnet bending angle of 0.1047 rad. Current ripple spec. (referred to I_{max}) of 5 ppm for freq. 60 Hz and greater. This gives a ~ 524 nrad noise in the horizontal direction.
- power supply parameters:
 - resolution of reference current 18 bit \pm 1 LSB
 - stability (8 h-10 s) – referred to I_{max} 40 ppm
 - stability (10s-300 ms) – referred to I_{max} 20 ppm
 - stability (300 ms- 0 ms) – referred to I_{max} 10 ppm
 - absolute accuracy – referred to I_{max} 100 ppm
 - reproducibility long term – referred to I_{max} 50 ppm

(a 1960s example: 10ppm design goal for MURA ring, eventually first dedicated light source)

Power Supply Diagram

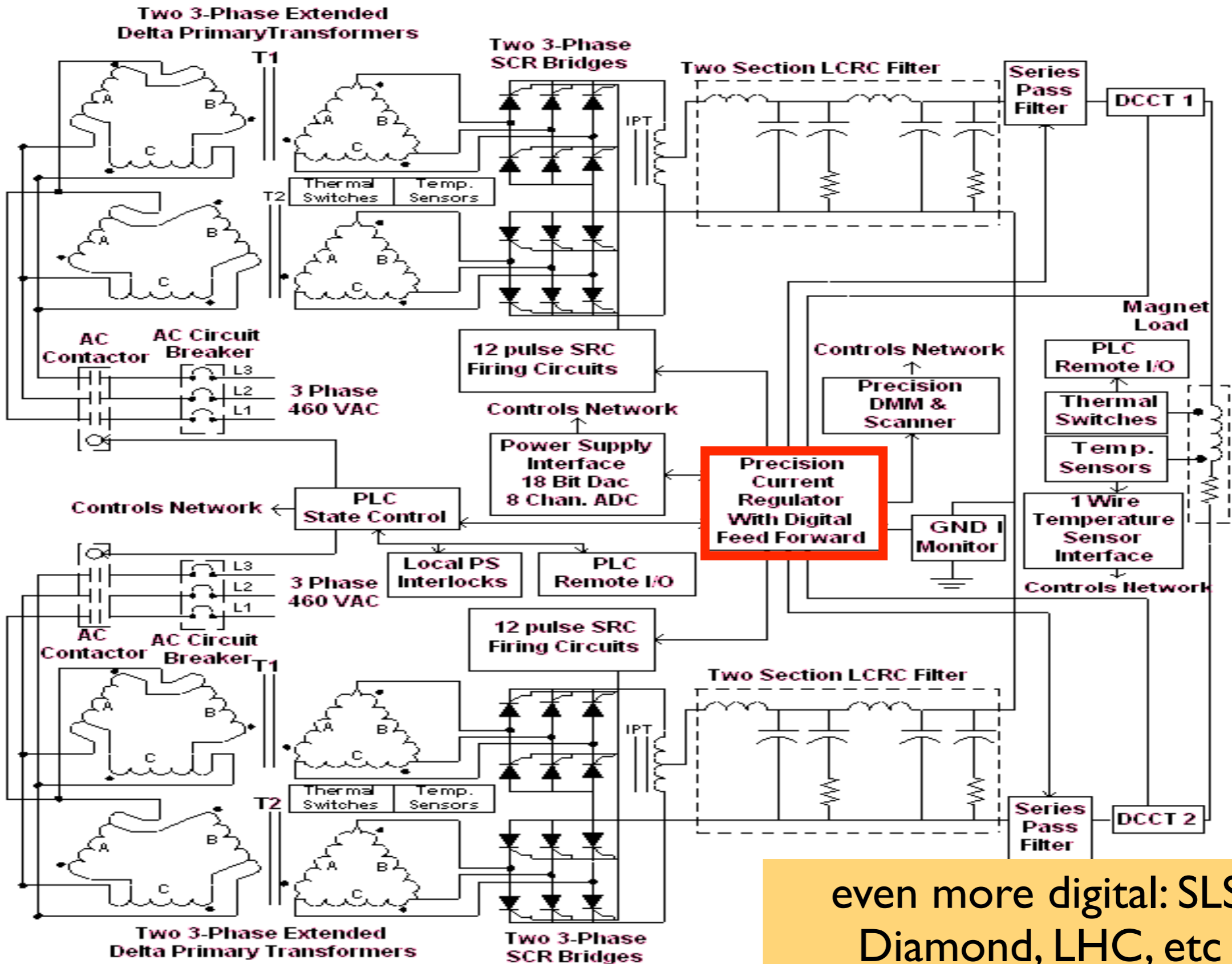

even more digital: SLS, Diamond, LHC, etc

ALS Orbit Feedback

- Motivation: Fast Orbit stability with passive measures already very good (2-4 microns rms). Improvement into $< \mu\text{m}$ range required active/fast feedback

- Combination of fast and slow feedback – no frequency deadband
- Fast Feedback currently 24 BPMs in each plane and 22 correctors in each plane. 1.11 kHz update rate, bandwidth DC-60 Hz. Only $\frac{1}{2}$ of singular values used.
- Slow Feedback 52 BPMs/plane, 26 horizontal correctors, 50 vertical correctors, RF frequency correction. 1 Hz update rate, about 60% single step gain, bandwidth DC-0.1 Hz. Typically all SVs used.
- Slow feedback communicates with fast feedback to avoid interference in frequency overlap range. Setpoints/golden orbit used by fast feedback is updated at rate of slow feedback.

Distributed Fast Beam Position Feedback 1.0 12/00

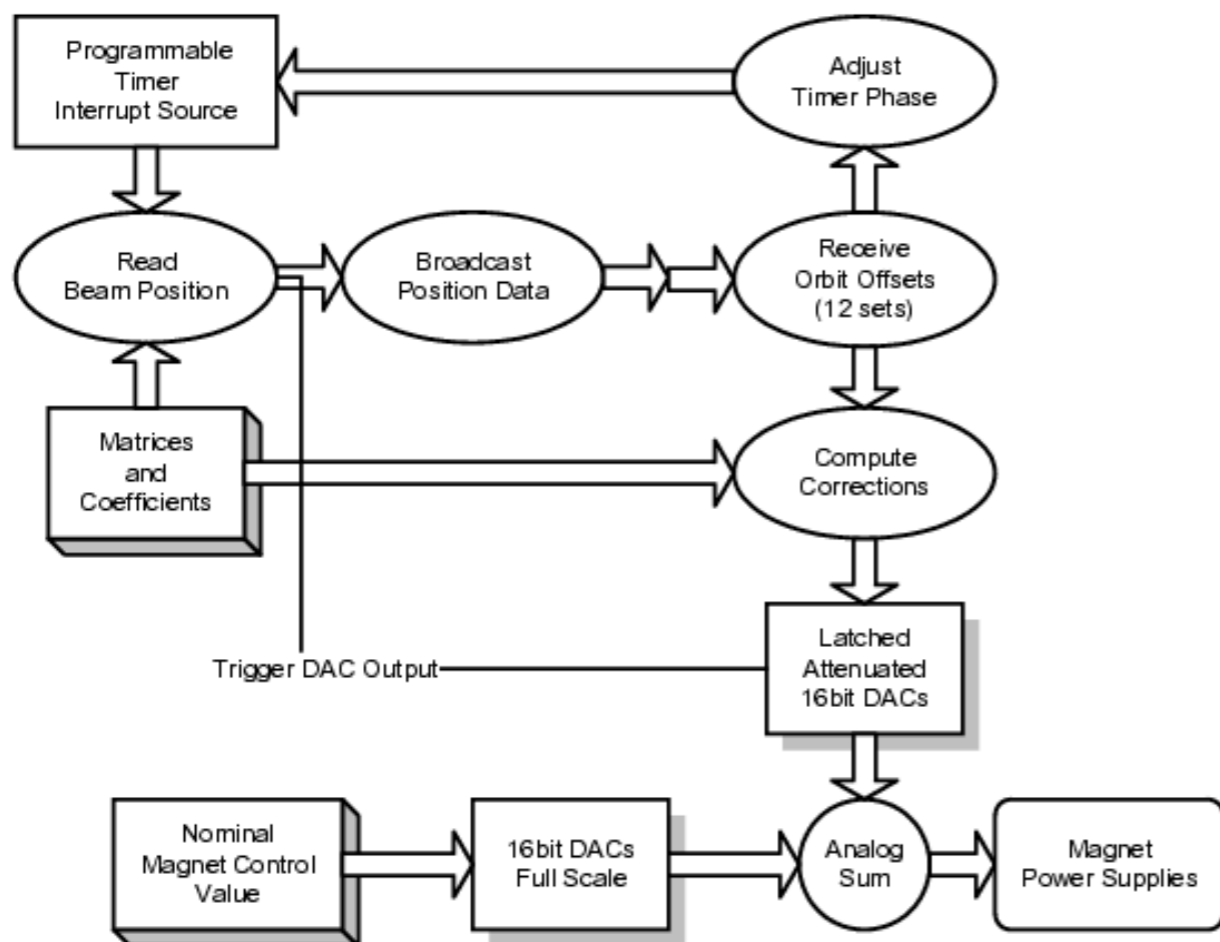

Beam spectra with feedback

Horizontal Power Spectral Density

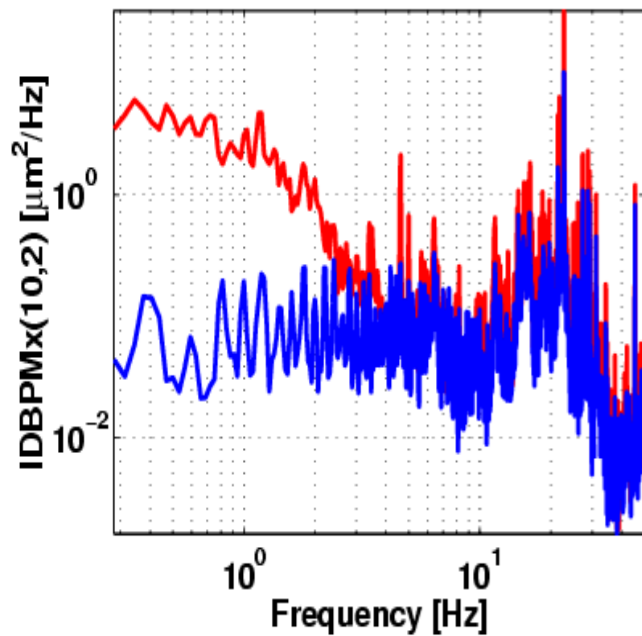

Vertical Power Spectral Density

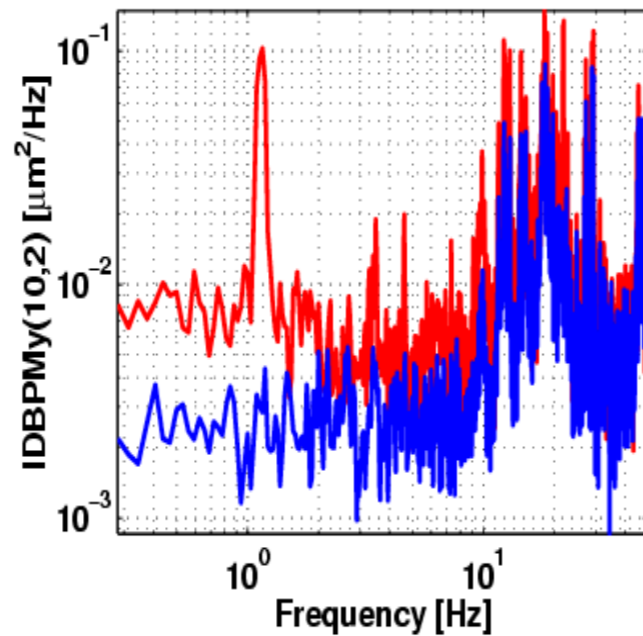

Cumulative [PSD]

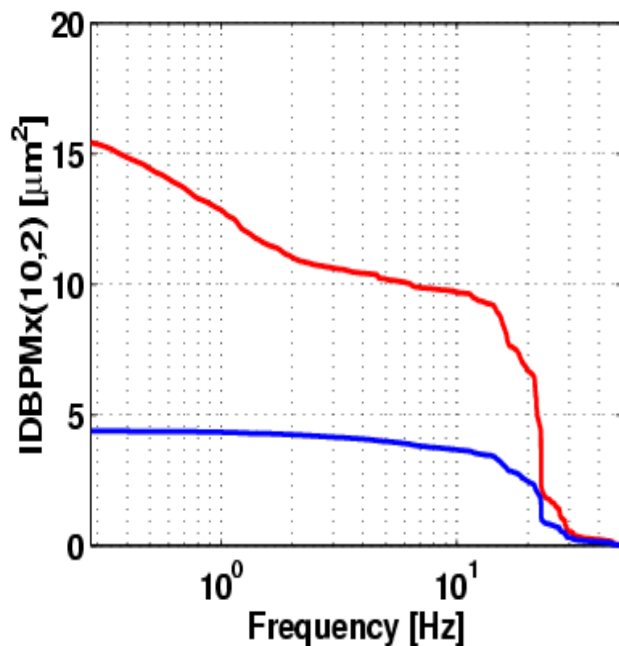

Cumulative [PSD]

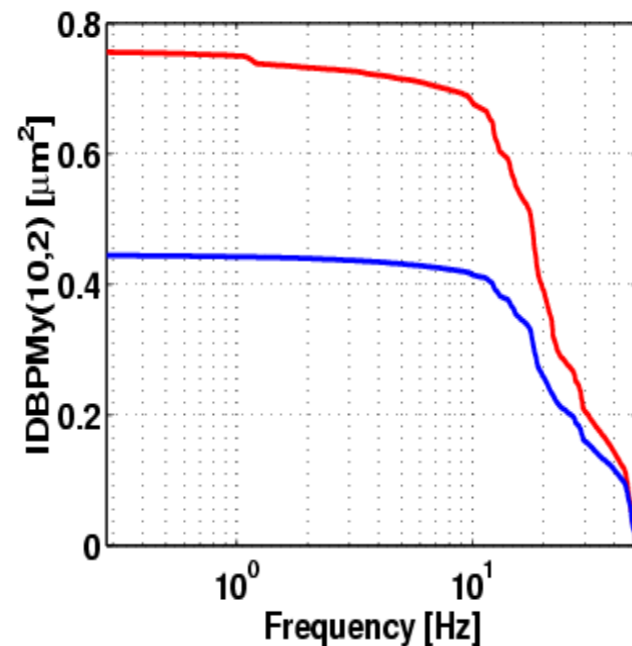

- Beam motion with feedback in open (red) and closed loop (blue) at out of loop BPM.
- Feedback is very effective for moderate frequencies. Right now closed loop bandwidth (3 dB) is about 80 Hz.
- Correction at low frequencies below the individual BPM noise floor (only 1/2 of SVs used).

LCLS Output

- Slice emittance $> 1.8 \mu\text{m}$ will not saturate
- leads to unstable output power

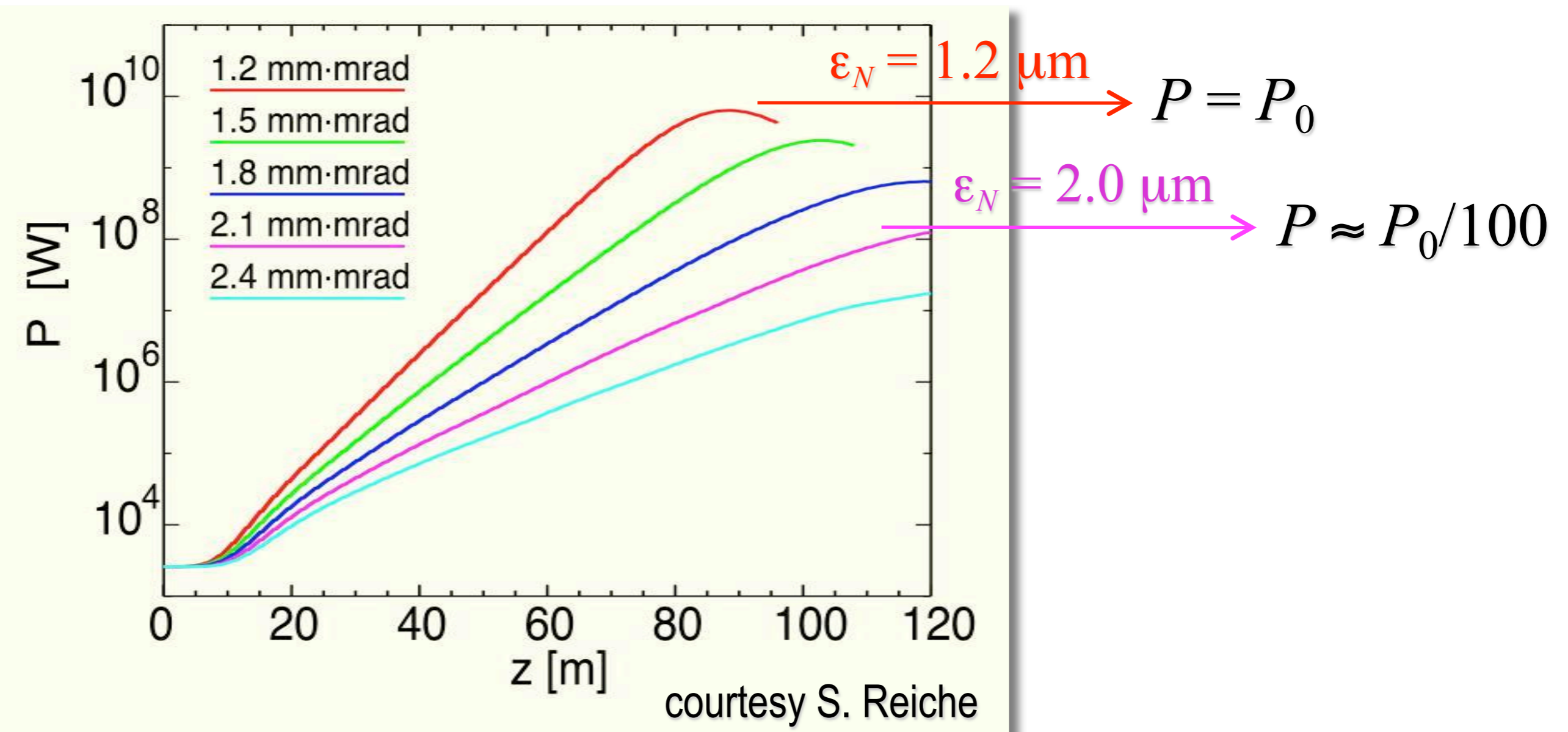

electron beam must meet brightness requirements

LCLS Machine Stability Tolerance Budget

$$|\langle \Delta E/E_0 \rangle| < 0.1\% \quad \underline{\text{and}} \quad |\Delta I/I_0| < 12\%$$

Parameter	Symbol	LCLS	Unit
Gun timing jitter	Δt_0	0.80	psec
Initial bunch charge	$\Delta Q/Q_0$	2.0	%
mean L0 rf phase	φ_0	0.10	deg
mean L1 rf phase	φ_1	0.10	deg
mean Lh rf phase <small>X-band</small>	φ_h	0.50	^{X-} deg
mean L2 rf phase	φ_2	0.07	deg
mean L3 rf phase	φ_3	0.15	deg
mean L0 rf voltage	$\Delta V_0/V_0$	0.10	%
mean L1 rf voltage	$\Delta V_1/V_1$	0.10	%
mean Lh rf voltage	$\Delta V_h/V_h$	0.25	%
mean L2 rf voltage	$\Delta V_2/V_2$	0.10	%
mean L3 rf voltage	$\Delta V_3/V_3$	0.08	%

RMS tolerance budget for <12% rms peak-current jitter or <0.1% rms final e⁻ energy jitter. All tolerances are rms levels and the voltage and phase tolerances per klystron for L2 and L3 are \sqrt{Nk} larger, assuming uncorrelated errors, where Nk is the number of klystrons per linac.

Tightest tolerance is 0.5° X-Band, Or 120 femtoseconds

LCLS beam-based RF feedback loops

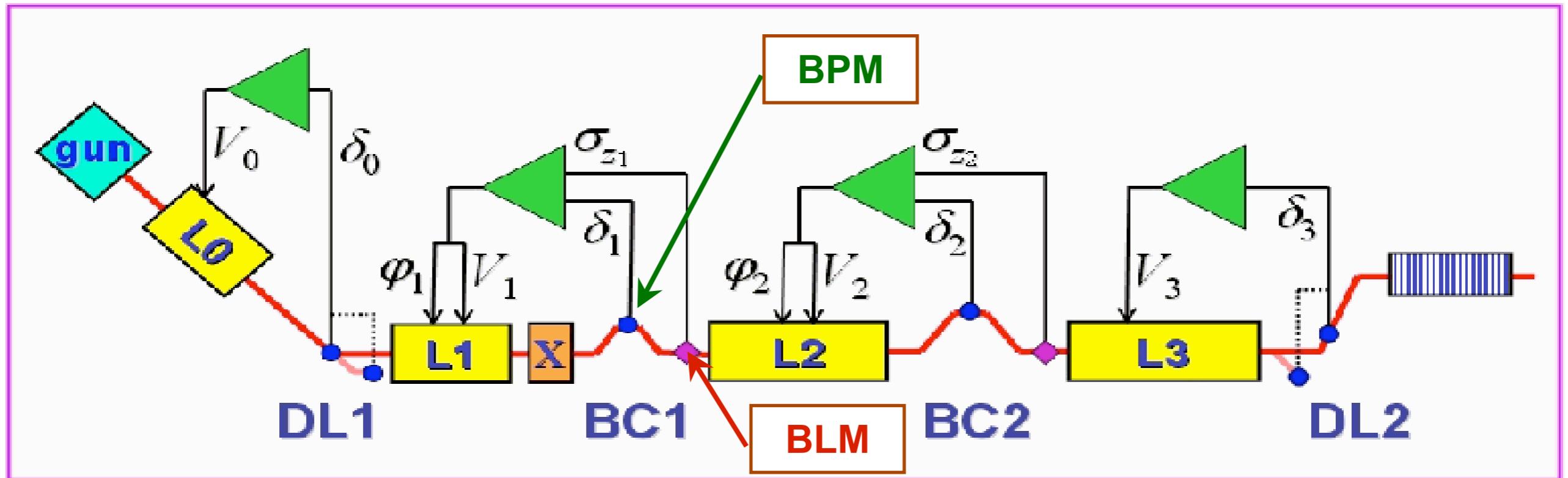

- Observables (6):
 - Energy: E_0 (at DL1), E_1 (at BC1), E_2 (at BC2), E_3 (at DL2)
 - Coherent Radiation power → bunch length: $\sigma_{z,1}$ (at BC1), $\sigma_{z,2}$ (at BC2)
- Controllables (6):
 - Voltage: V_0 (in L0), V_1 (in L1), V_2 (effectively, in L2)
 - Phase: φ_1 (in L1), φ_2 (in L2), φ_3 (in L3)

XFEL transverse feedback

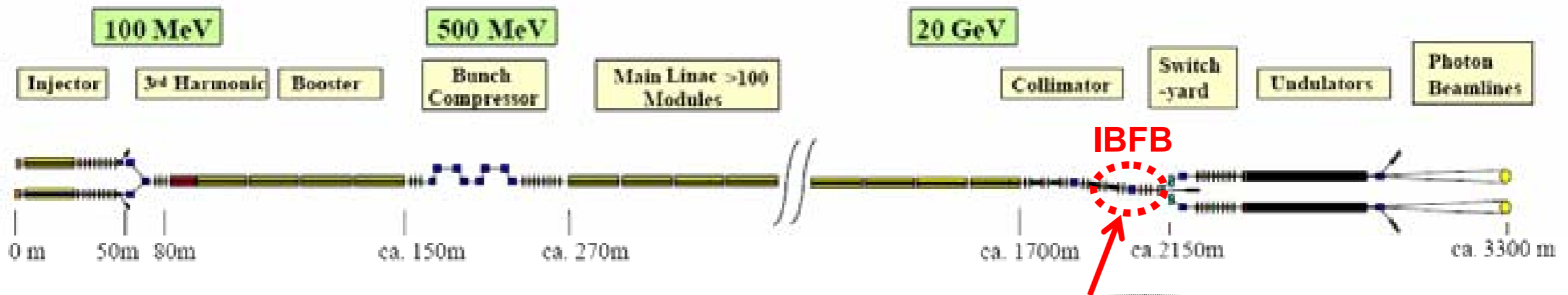

XFEL Main Linac Parameters

- $Q = 1 \text{ nC}$, $L \sim 80 \text{ fs}$, $E = 20 \text{ GeV max.}$
- Beam size $\sim 30 \mu\text{m}$ (undulators)
- **Trains of ~ 3000 bunches, spacing 200 ns , 10 Hz**

Motivation

- Need $\sim \sigma/10$ transverse position stability in undulators
- Possible x/y beam position perturbation: water/helium flow, ground motions, power supply jitter, switching magnets, RF transients and jitter, photo-cathode laser jitter & related beam current variations, long range wakefields

- Use IBFB to damp perturbations (up to some 100 kHz)

IBFB Concept & Topology

- Calculate kicks for bunch N from upstream BPM positions of bunches $N-1$, $N-2$, $N-3$, ... (using an optics model) to reduce latency (upstream BPM signals travel in same direction as beam)
- Use downstream BPMs to check & adapt model (slowly)

IBFB Topology for Horizontal Plane (Same for Vertical Plane)

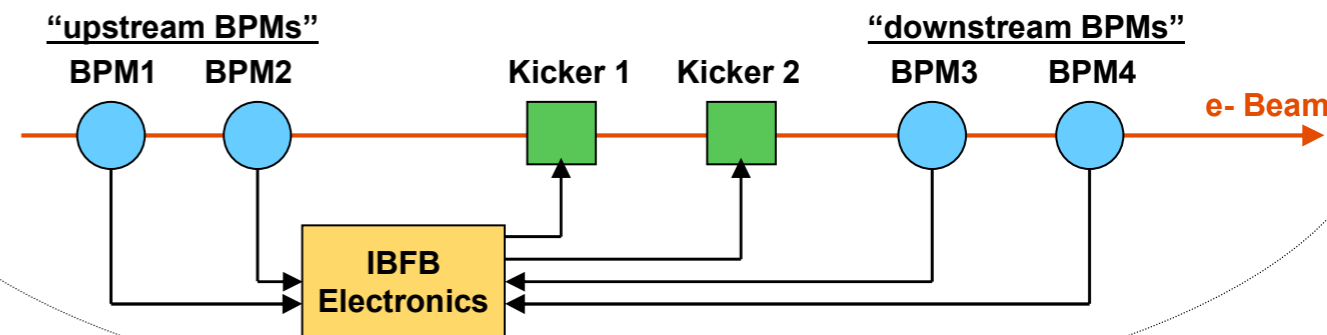

Transv. IBFB Specifications	FLASH	XFEL
bunch-by-bunch stability - at location of IBFB - along undulators	$< \sigma/10$ $5 - 15 \mu\text{m}$ $< 5 \mu\text{m}$	$< \sigma/10$ $3 - 10 \mu\text{m}$ $< 3 \mu\text{m}$
max. beam position correction max. position offset at pickups	$< 10 \cdot \sigma$ $< 1.5 \text{ mm}$	$< 10 \cdot \sigma$ $< 1 \text{ mm}$
bunch-by-bunch resolution	$\leq 2 \mu\text{m}$	$\leq 1 \mu\text{m}$
system latency	$< 1000 \text{ ns}$	$< 200 \text{ ns}$

Operational Improvements

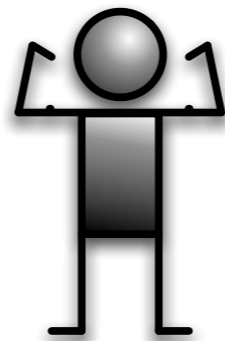

Protecting CEBAF

- 1500 MHz cavity pickups
- stability: 100 nA
- Minimum detectable loss: 200nA
- DSP-based system provided stability, and an order of magnitude better sensitivity over analog system

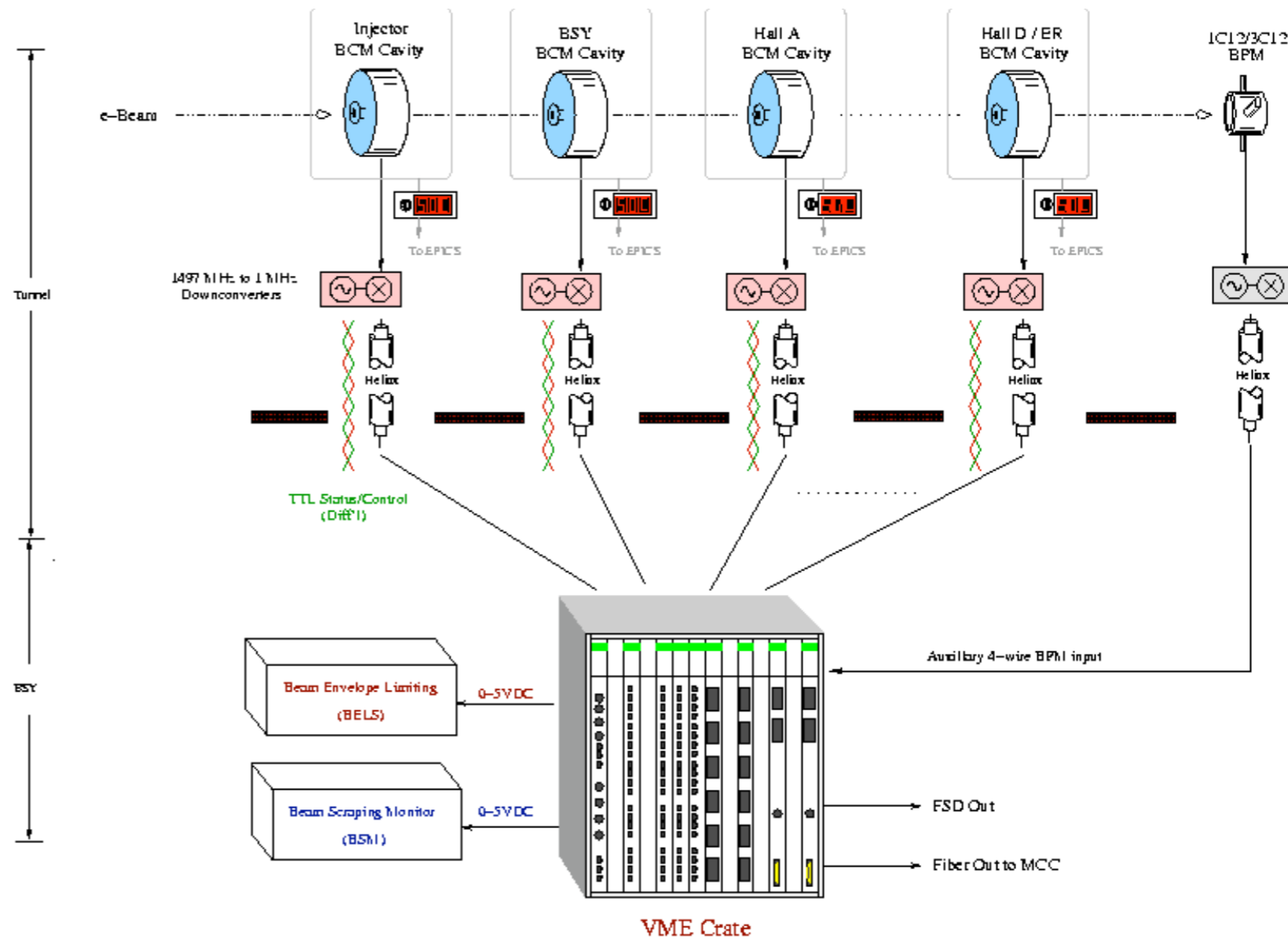

Laser Stabilization

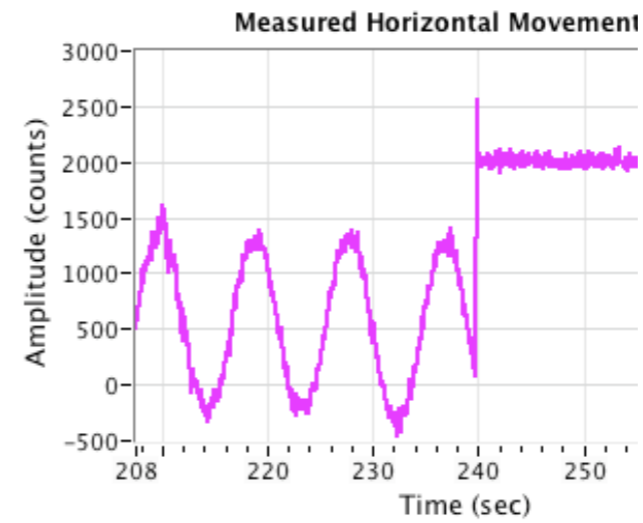
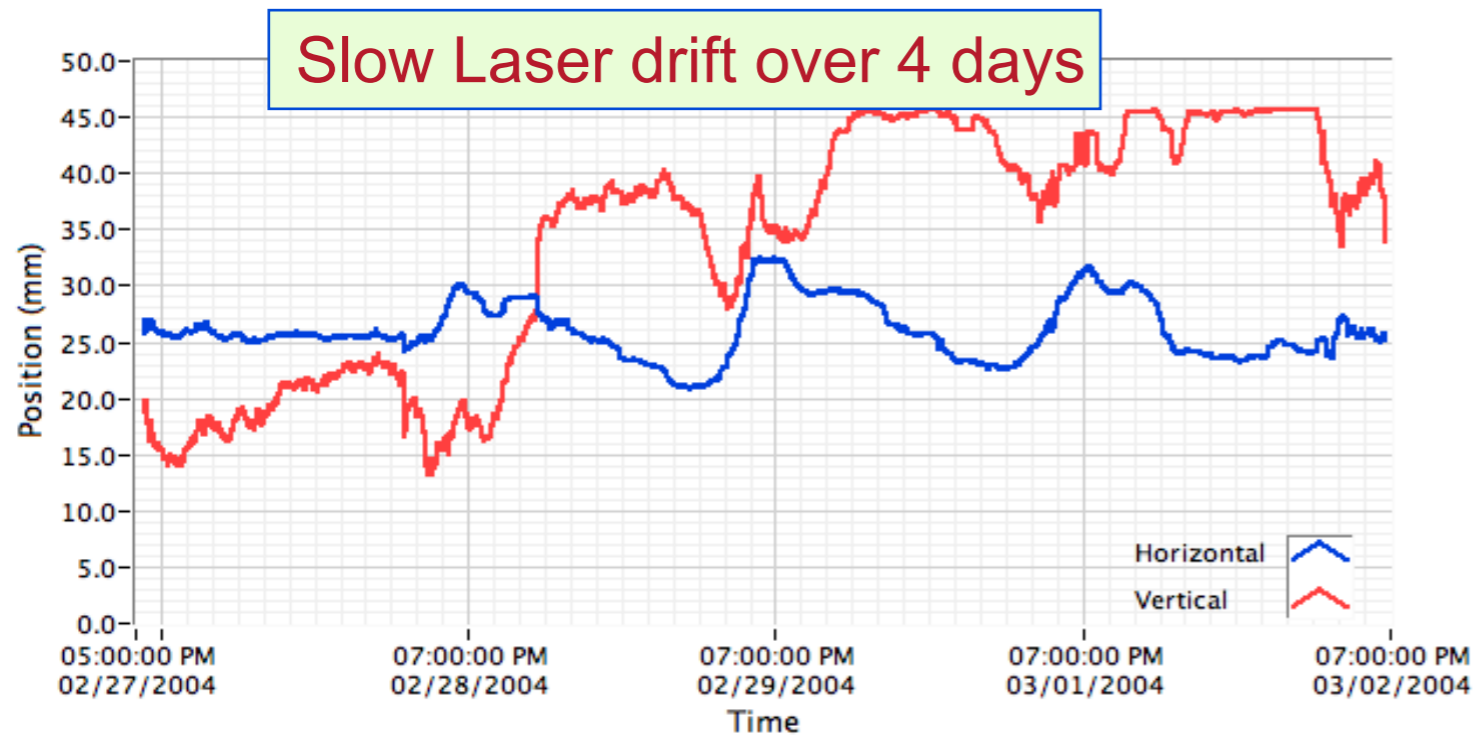

Sinusoidal steering error, then stabilization enabled (Quad sensor, piezo actuator, FPGA feedback)

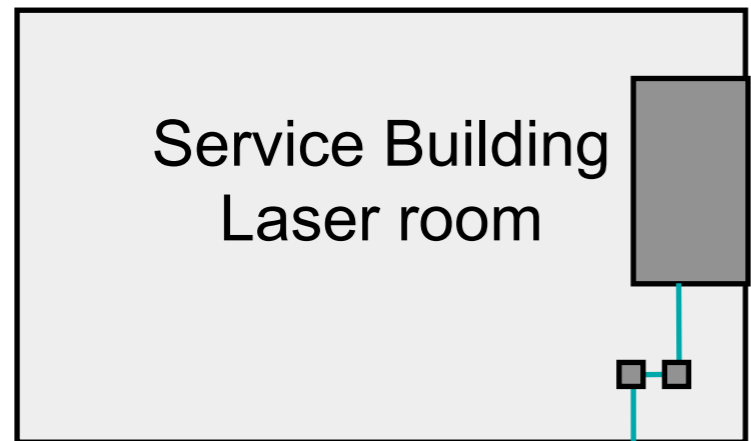

200m transport to keep laser out of radiation area

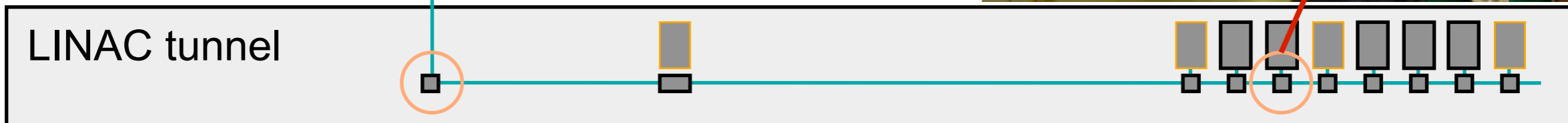

Locking an Accelerator to a Spinning Wheel

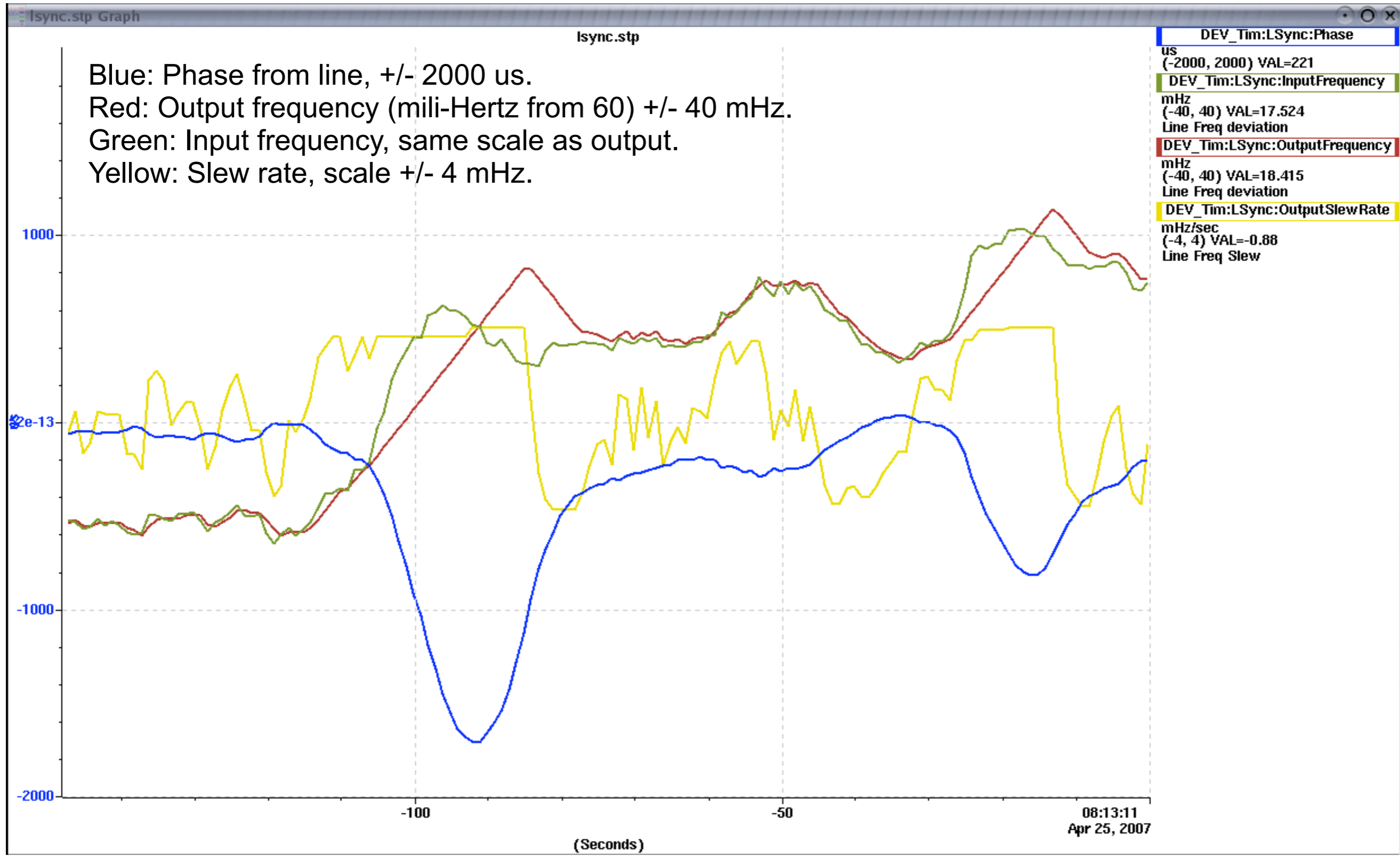

Considerations

- Beam Signals
- Radiation Environment
- Obsolescence

Beam Signals

Beam Bunch Structures in Fermilab Main Injector

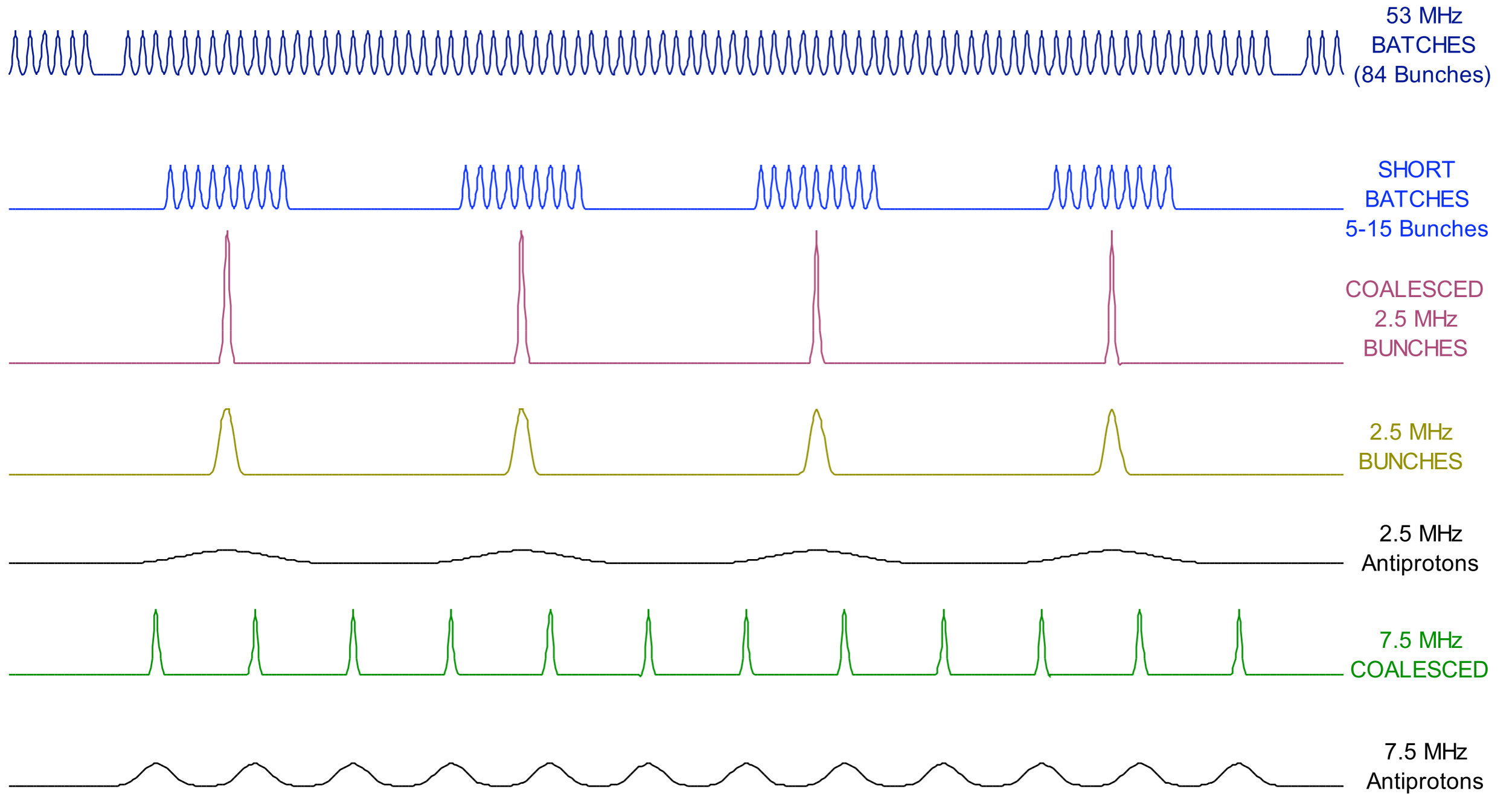

... dealing with this variety of beams would be painful in Analog...

**Recycler BPM Preamp Signal with 4 bunches at 2.5 MHz
Prieto's Low-Q Preamp with 10 nsec (100 MHz) Digitization**

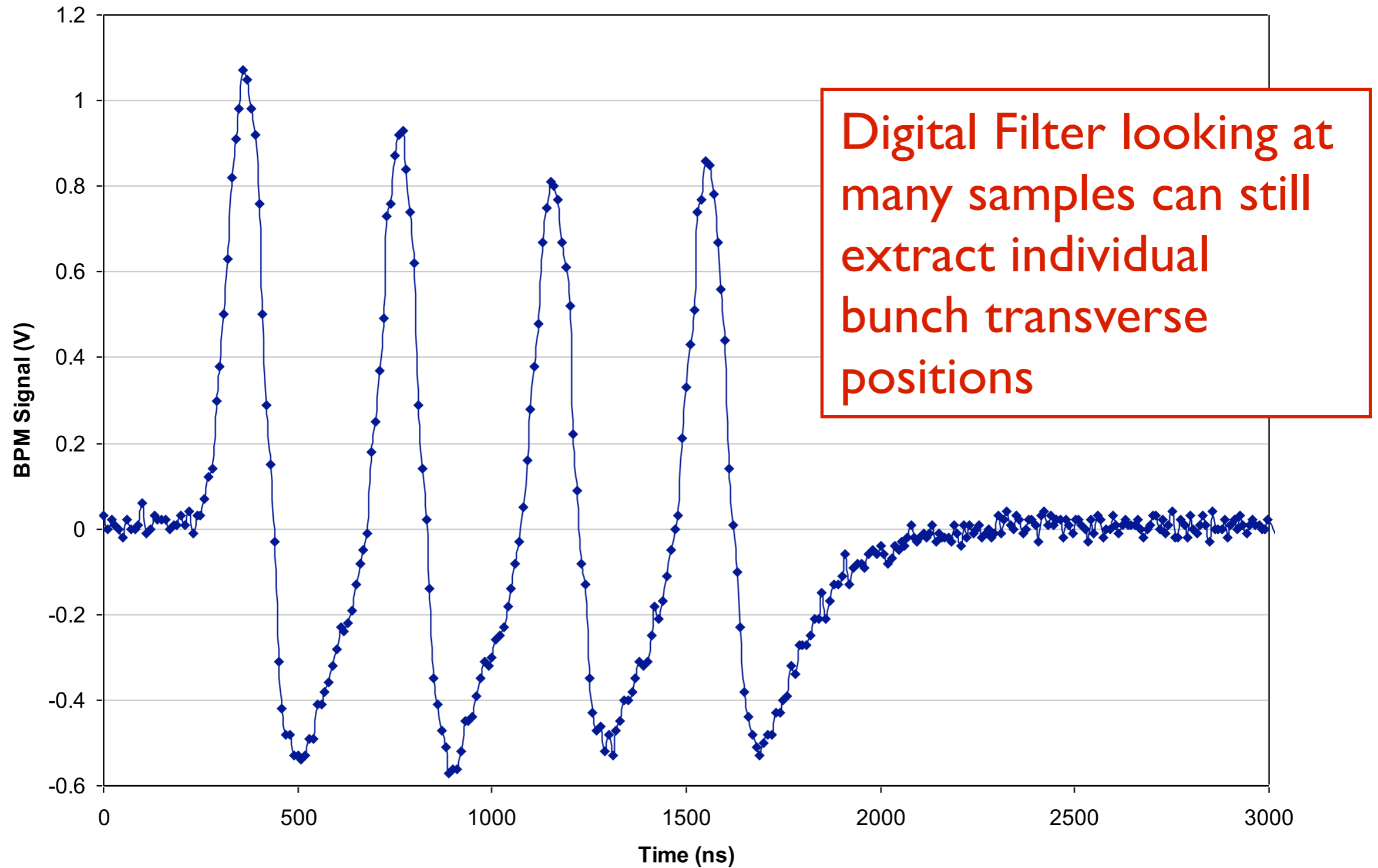

- Accelerator provides many possible sources of electromagnetic interference
- grounding, shielding, isolation techniques (Ott's book, and Analog to Digital Lecture)

Undersampling IF from a 300 ns Minipulse

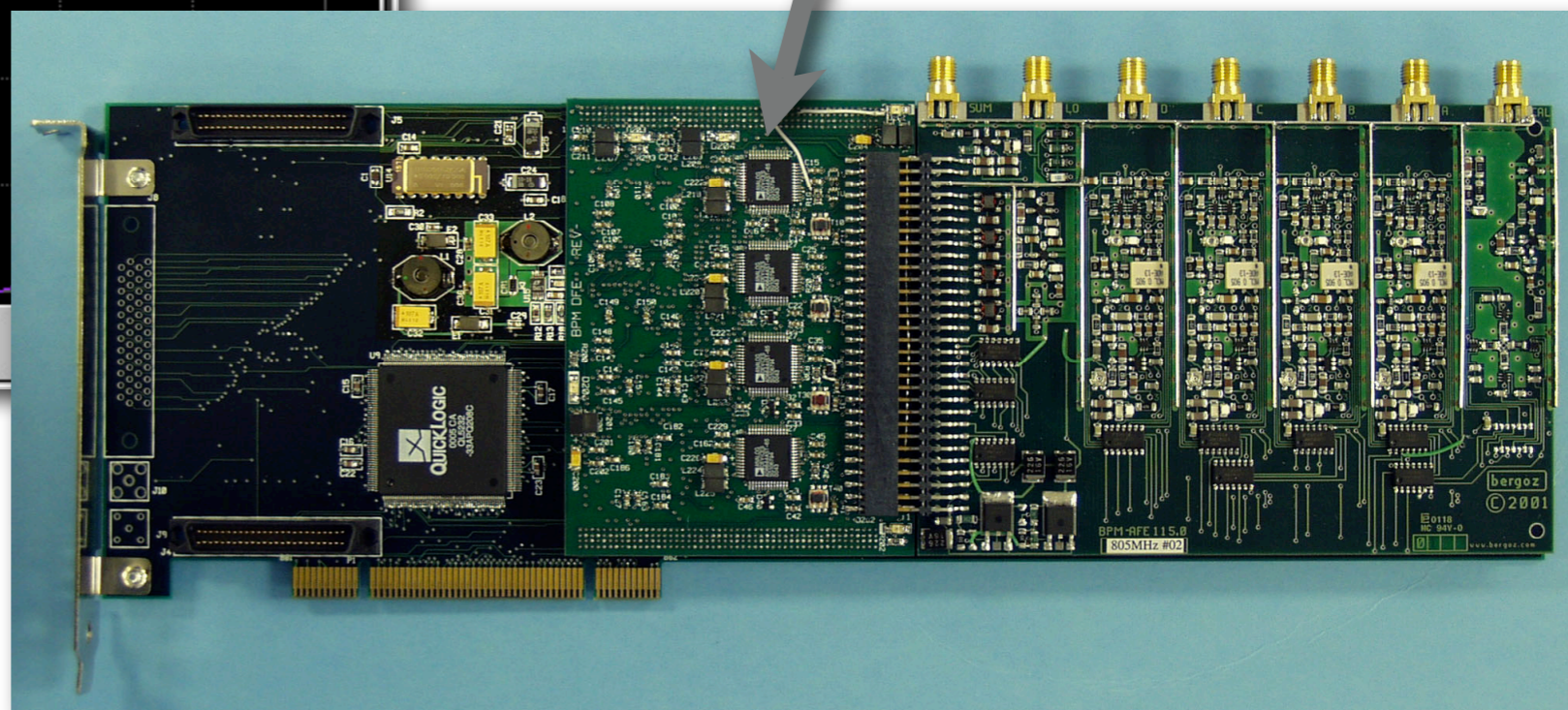
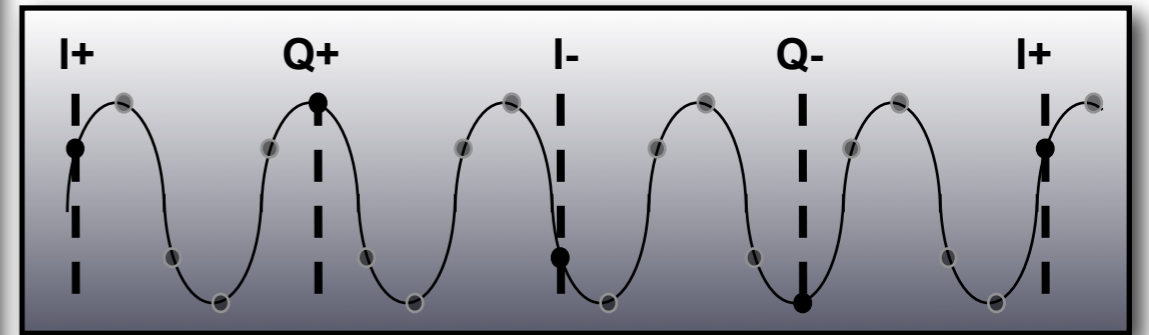
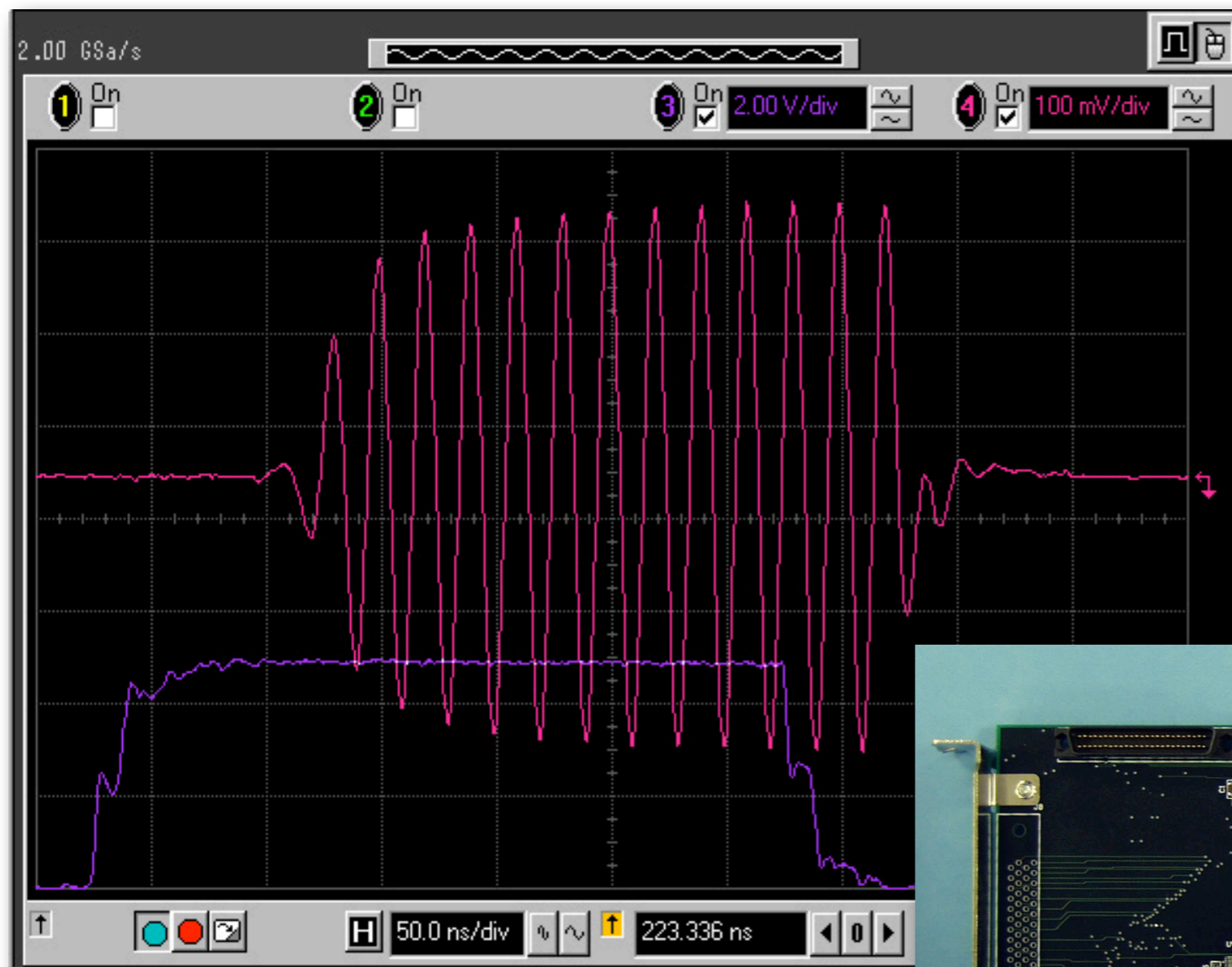

Dynamic range during multi-turn injection

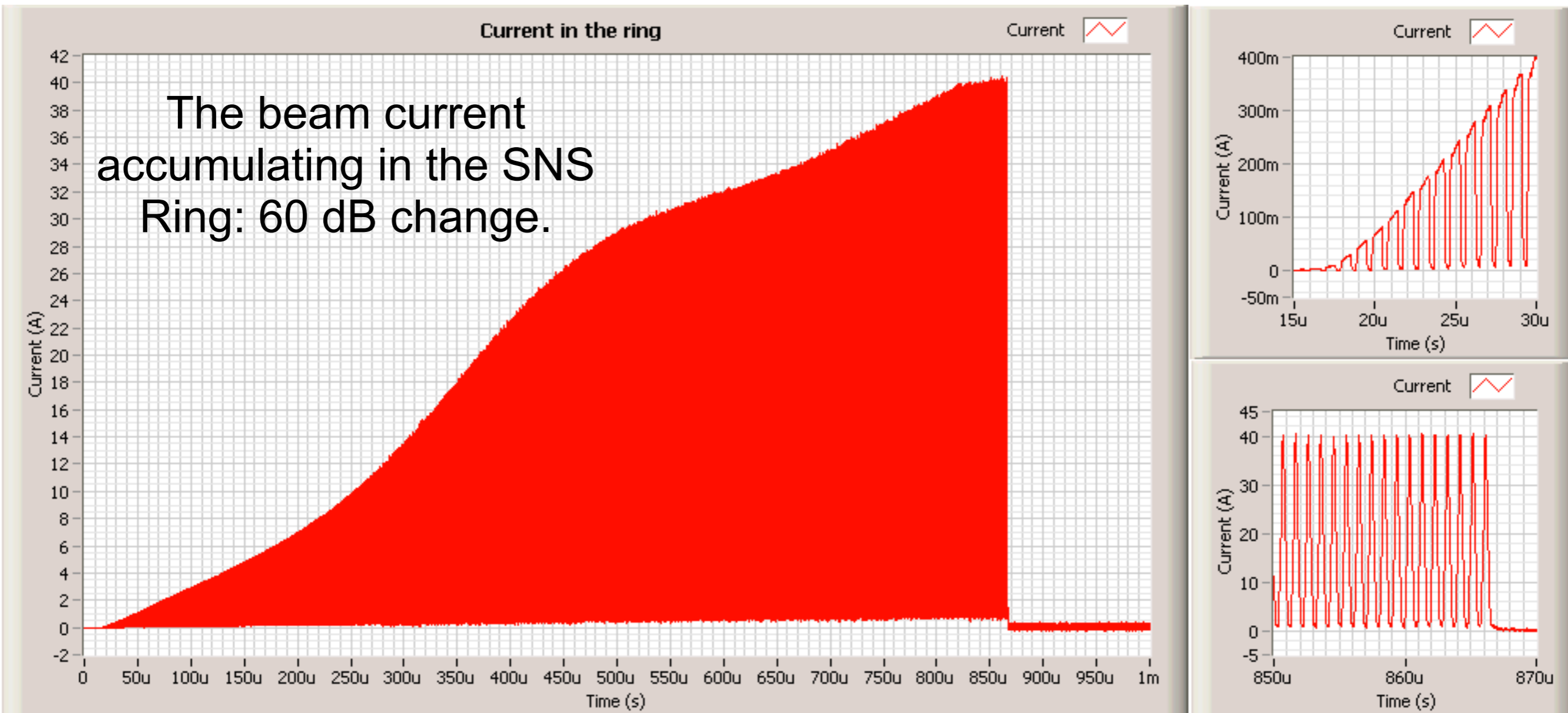

- Current Monitors: 4 ADCs in parallel to assure valid data in off-normal conditions
- Most others: switched gain

Radiation

Radiation Dose Prediction

SNS SCL MCNPX Models:

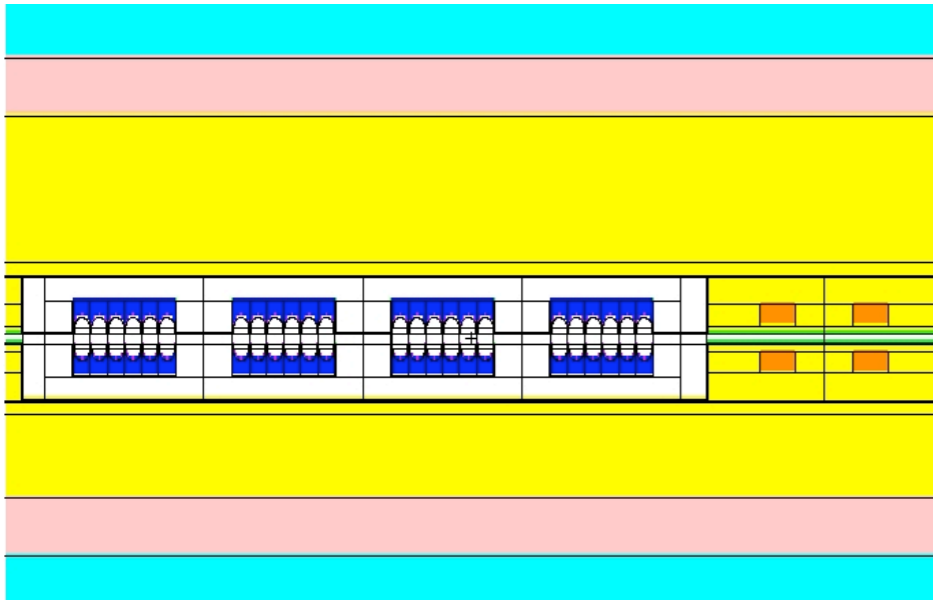

Radiation Transport Calculations
(MCNPX, FLUKA ...) \Rightarrow calculate
Absorbed Dose, Displacements-
per-Atom in components directly or
by folding particle fluxes with
KERMA factors or displacement
cross sections
 \Rightarrow life time prediction

SNS Linac Beam Loss Characteristics: Beam Loss

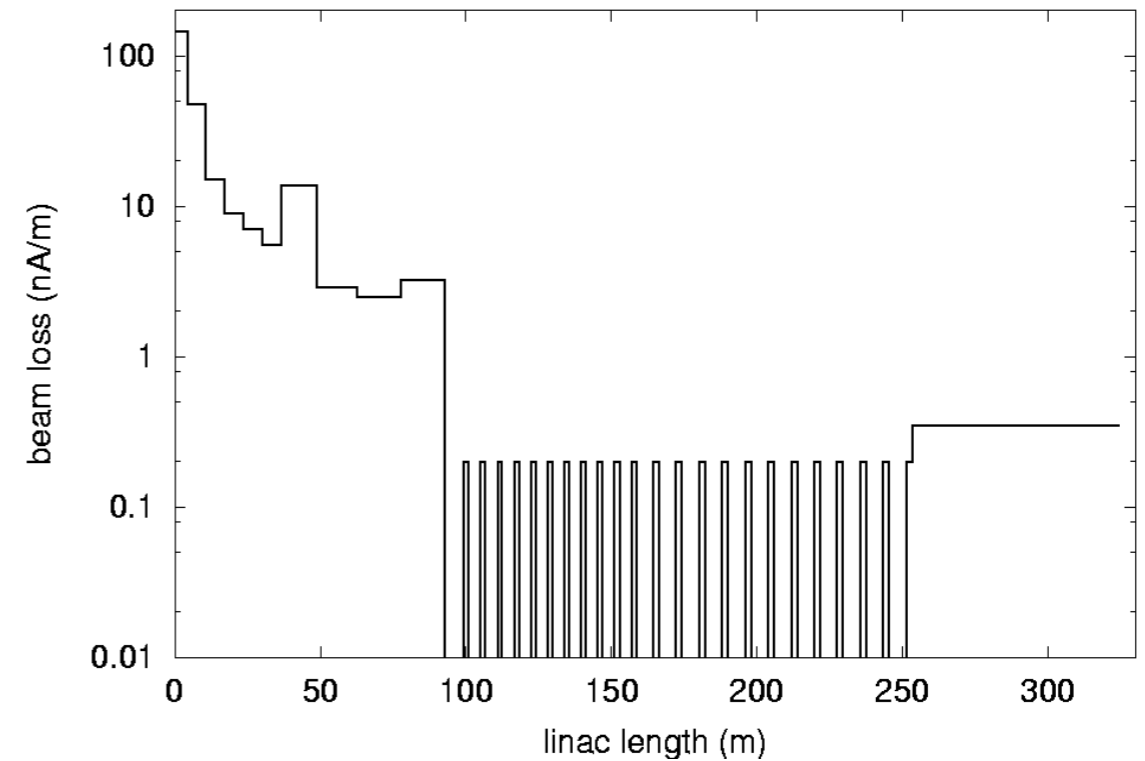

SNS Operational Silicon Dose between low beta SCL modules

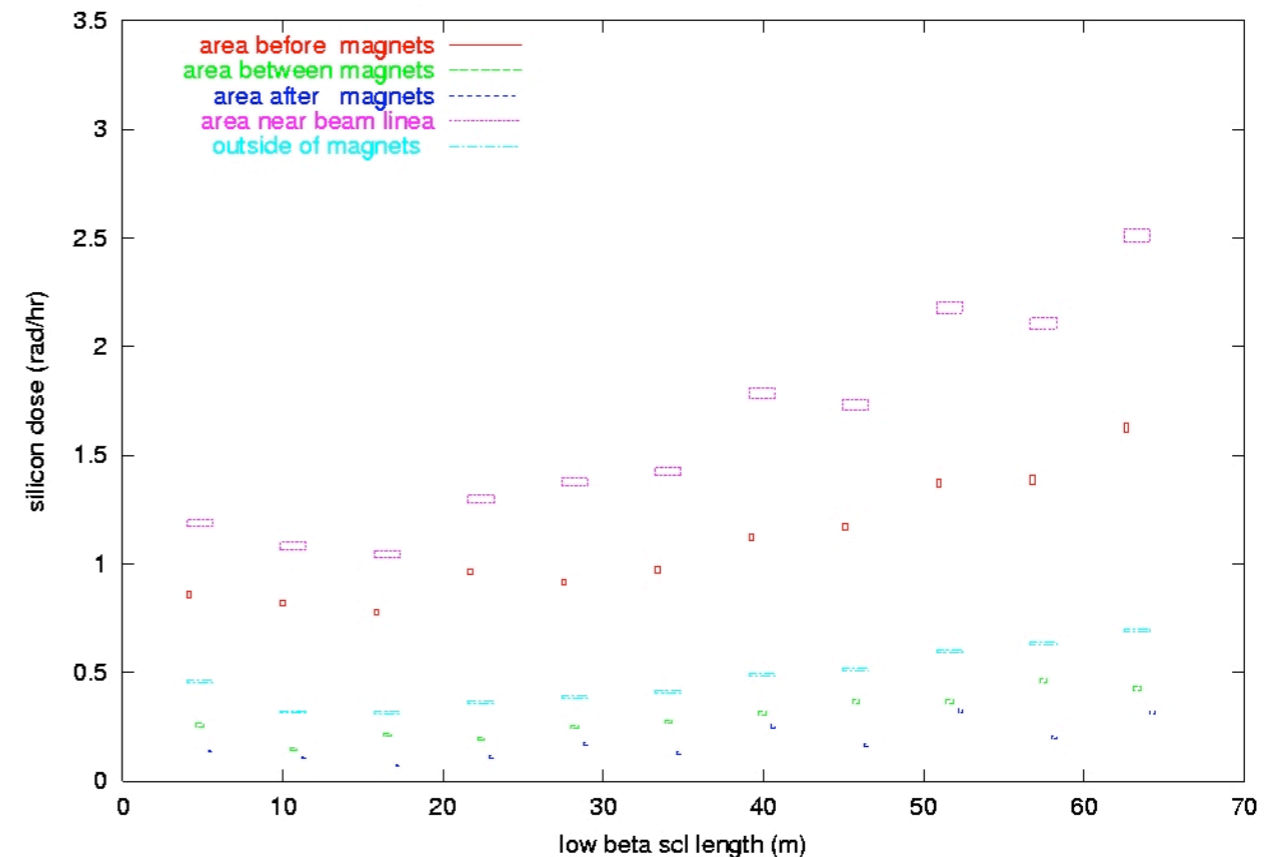



Radiation Tolerance

Total Ionizing Dose	Technology
~1 MRad (Si)	Radiation Hardened ASIC
~100 kRad	Radiation hardened FPGAs with redundancy and SEU correction
~10 kRad	You and the afternoon lab materials

Obsolescence

SNS Commissioning runs and latest technology in use:

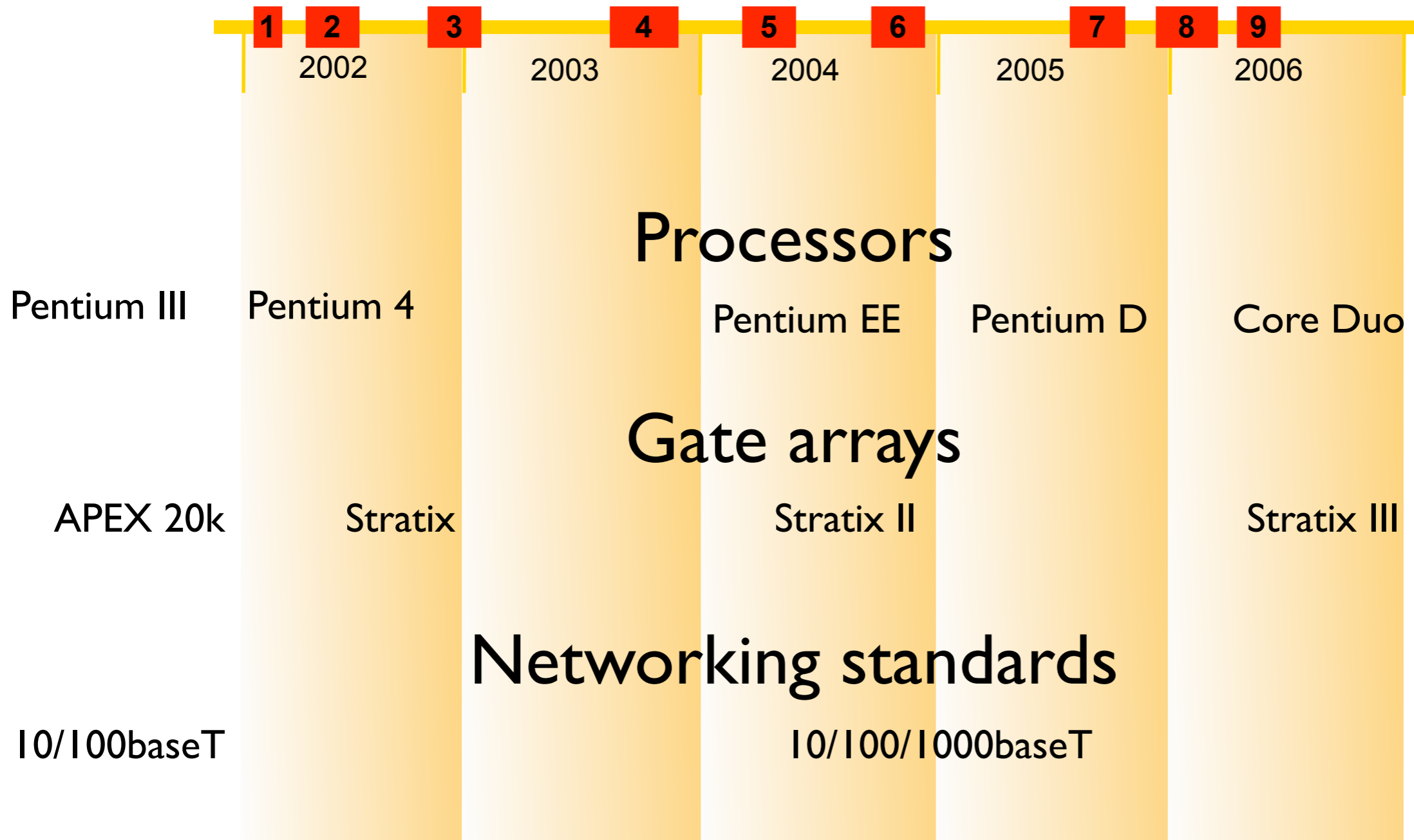

note: all ethernet interoperable and plug compatible (RJ45)

Final Comments

Assuring Success

- The goal: make it work, deploy it on time, build it within budget.
- Time and resources will be restricted
 - Phased deployment of features (or channels)
 - Watch for scope creep
 - scope of analog systems self limiting: “poetry”
 - for software based systems... “trashy novel”?
- Expectation Management. Clearly communicate:
 - interfaces
 - day one functionality
 - roadmap to full glory

Testing

Physics Model
with controller

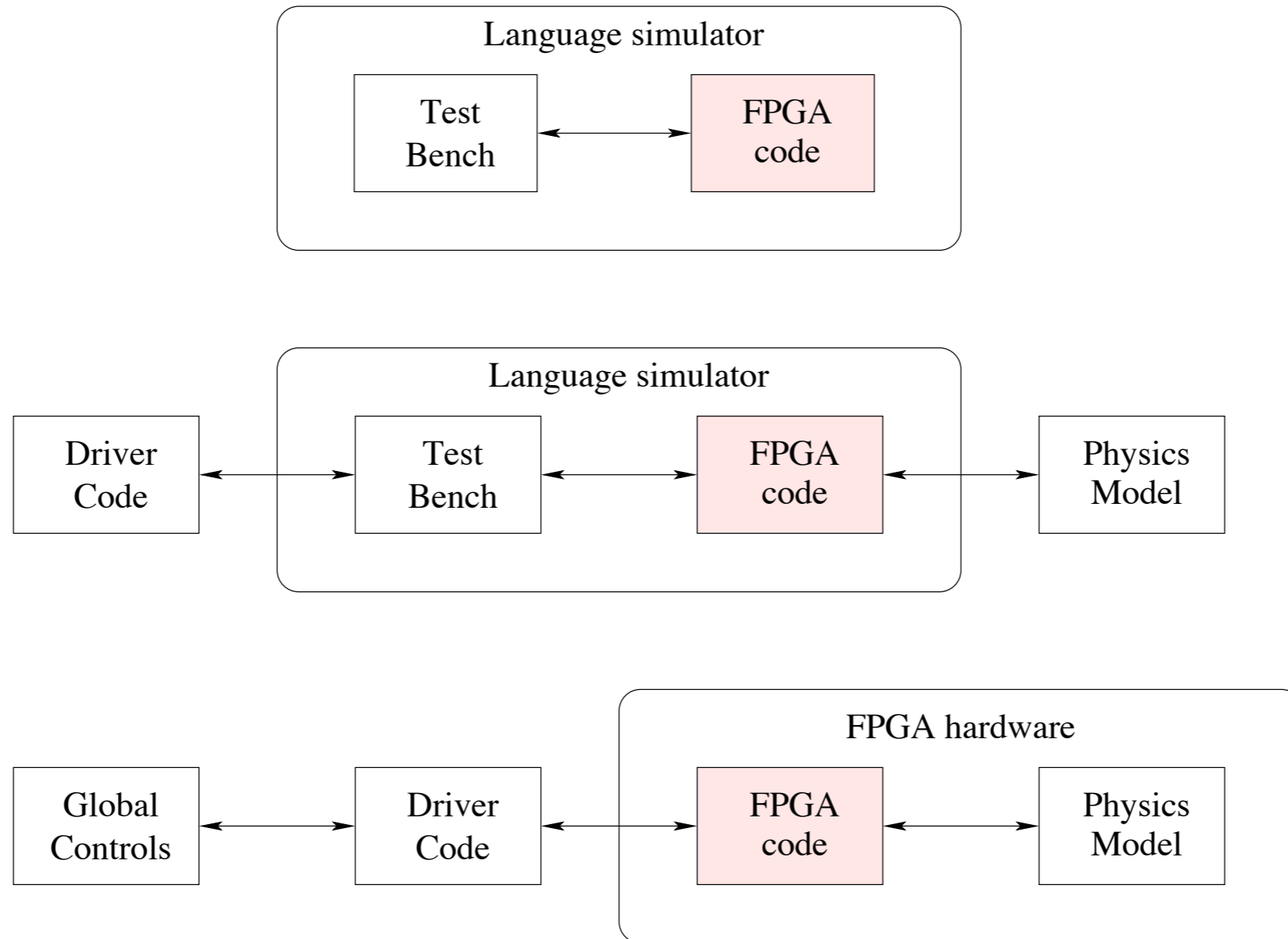

Commissioning

A few things that have made commissioning go smoothly in the past:

- Built in self test
- Access to raw waveforms, oversampled if possible
- Flexibility by using high level implementation
- NAD concept: keep integration independent of other systems, early vertical integration of first deployed channels
- Smile