

Energy Recovery Linacs

Virtual beam power for a multitude of applications

Andreas Jankowiak
Helmholtz-Zentrum Berlin and
Humboldt-Universität zu Berlin



Energy Recovery Linacs – Why and How ?

storage ring versus linac (real \leftrightarrow virtual power, equilibrium \leftrightarrow control)
the ERL principle and its promises

History

first idea, first tests, first projects

Applications

multi-user light sources, collider, cooler, compact sources

Challenges

electron source, SRF technology, beam losses
at the example of the Berlin Energy Recovery Linac Project bERLinPro

more details on many aspects e.g.:
<https://indico.cern.ch/event/470407/>
ERL2017, ICFA Workshop
CERN, Genf

Storage ring ↔ linac / virtual ↔ real power

synchrotron radiation source, collider

$$P_{\text{virtual}}[\text{W}] = E[\text{eV}] \cdot I[\text{A}]$$

$$E_{\text{stored}}[\text{J}] = E[\text{eV}] \cdot I[\text{A}] \cdot T_{\text{rev}}[\text{s}]$$

e.g. BESSY II, 3rd generation light source

1.7 GeV, 300 mA = 510 MW virtual beam power,
thereof ca. 90 kW used synchrotron radiation power
(and only 408 J stored energy)

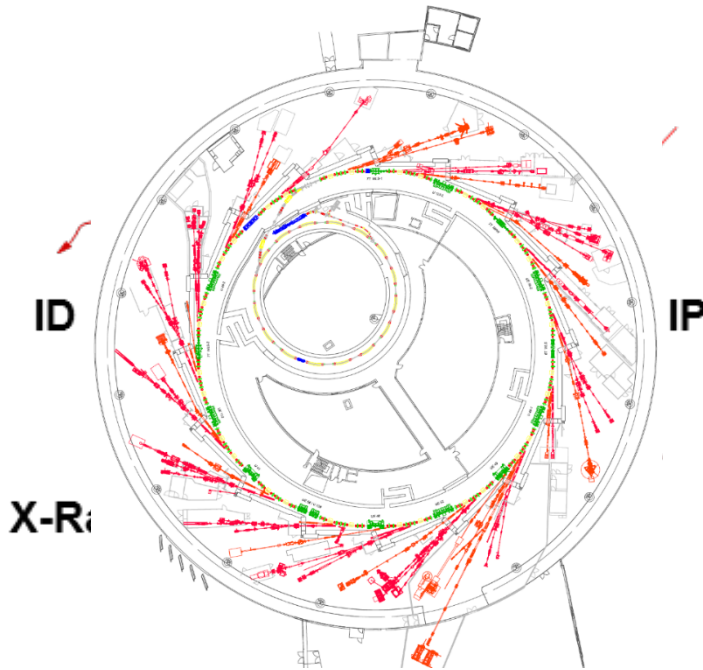

free electron laser, collider, fixed target

$$P_{\text{real}}[\text{W}] = E[\text{eV}] \cdot I[\text{A}]$$

e.g. European XFEL, 1 Å hard X-ray source

17.5 GeV, 0.027 mA = 475 kW real beam power,
ca. 100 GW peak power in 100 fs, 10 x 2700 pps,
used FEL power ca. 300 W

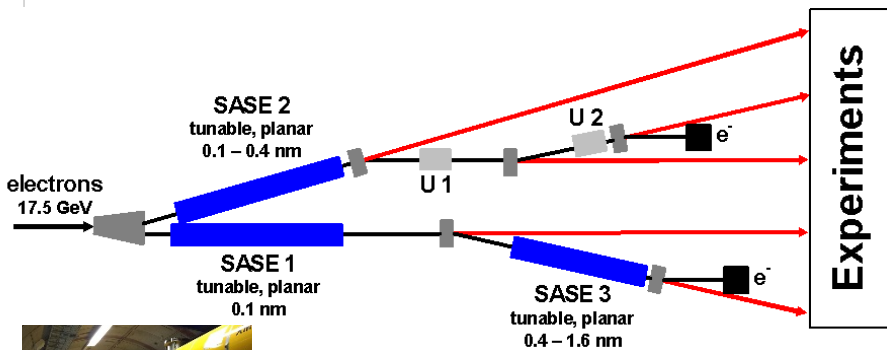

real ↔ „virtual“ beam power

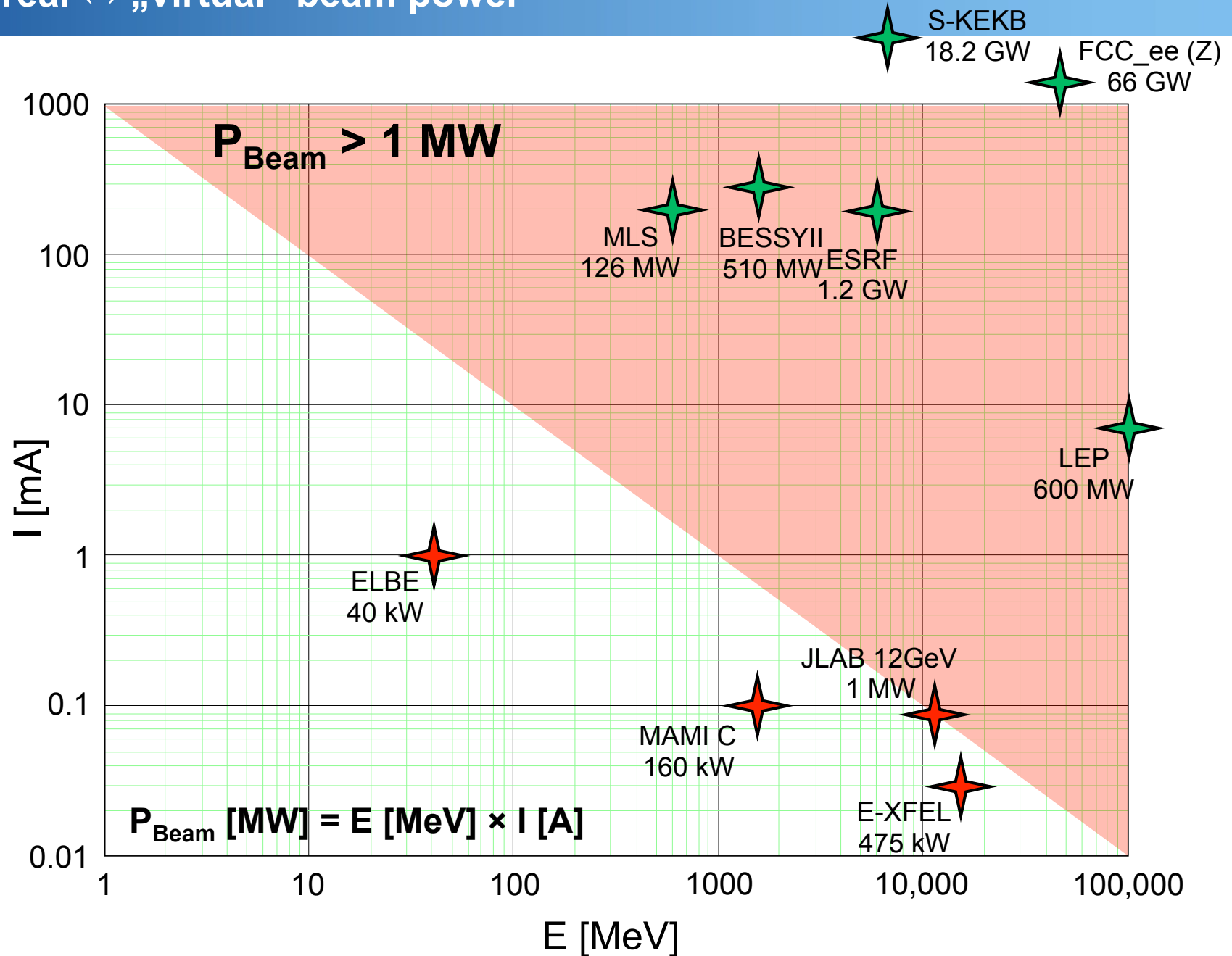

Storage ring – governed by equilibrium processes

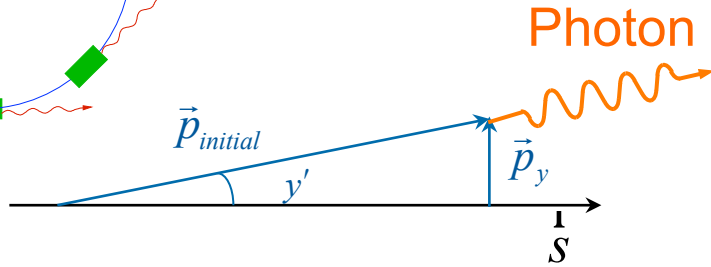
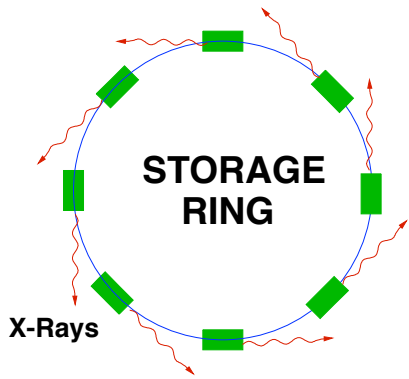

electron emits photon

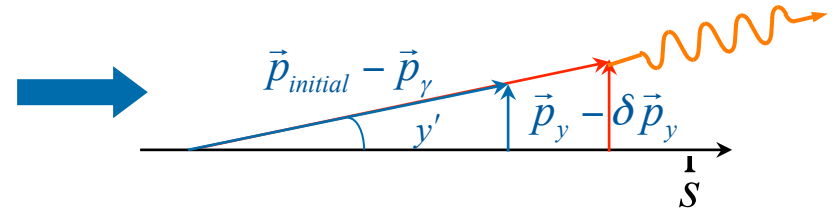

loses momentum (also transversal)

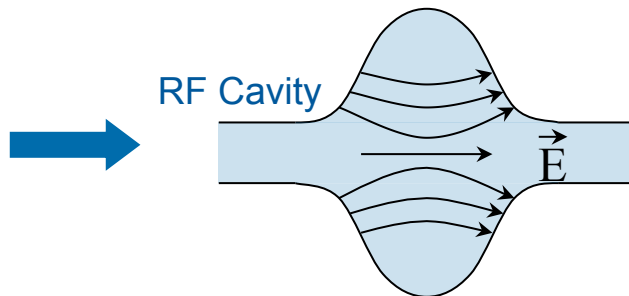

longitudinal momentum restored in acceleration cavity

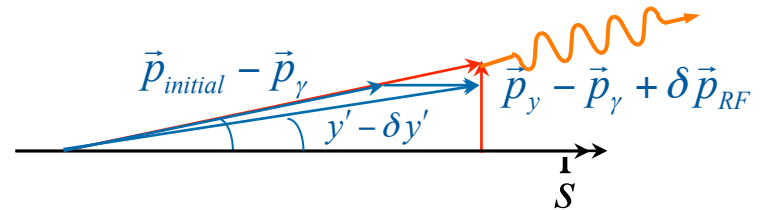

angle and displacement reduces
→ emittance shrinks

“damping”

Storage ring – governed by equilibrium processes

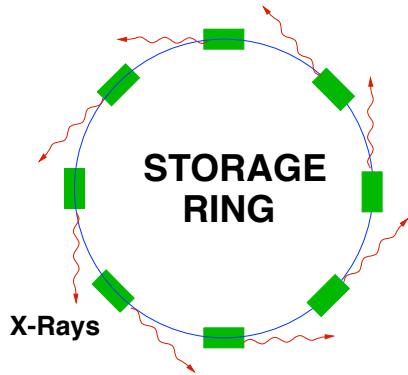

emission of photon at position with dispersion
(e.g. in dipole, where transversal position
is energy dependent)
electron oscillates around reference orbit
→ emittance increase

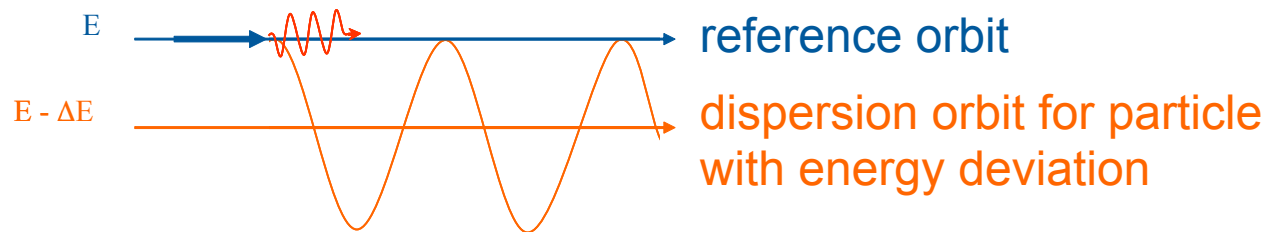

“heating”

emittance is defined by an equilibrium between these
two processes (damping and heating)
typical order: some nm rad horizontal (1/100 vertical)
similar process defined energy-spread and pulse length

Linac – governed by adiabatic damping and control

„adiabatic“ damping

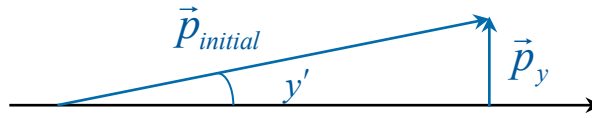
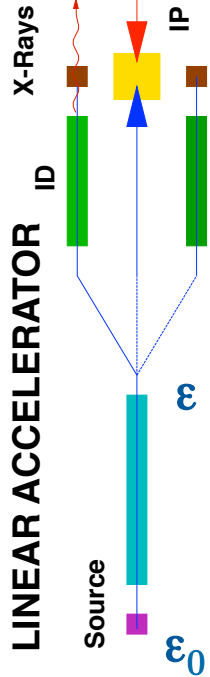

electron has transversal momentum

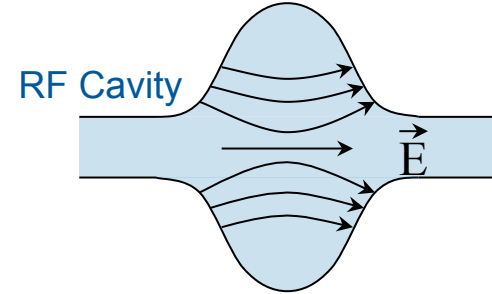

longitudinal component increases during acceleration

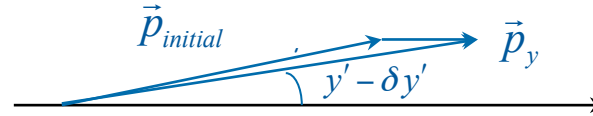

angle reduces with acceleration, emittance shrinks $\epsilon = \frac{\epsilon_0}{\gamma}$

additional: bunch-length control by applying correlated energy chirp (off crest) and magnetic chicane with longitudinal dispersion



The quality of the beam is defined by the source, the rest is proper acceleration and phase space control !

Storage ring versus Linac

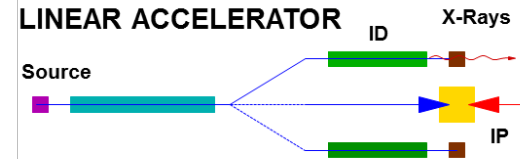
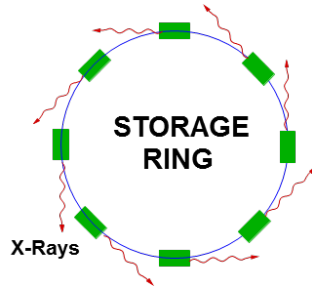

equilibrium beam dimensions

adiabatic damping + control

$\varepsilon_x = C_\gamma \cdot \frac{\gamma^2}{J_x} \cdot \frac{\left\langle \frac{1}{R^3} H(s) \right\rangle}{\left\langle \frac{1}{R^2} \right\rangle} \sim \frac{\gamma^2}{N^3}, \varepsilon_y = K \cdot \varepsilon_x$	$\varepsilon_{x,y} = \frac{\varepsilon_0}{\gamma}$
$\frac{\sigma_E}{E} \sim \frac{\gamma}{\sqrt{\rho}}$	$\left(\frac{\sigma_E}{E} \right)_0 \sim \frac{1}{\gamma}$
$\sigma_s \sim \sqrt{\frac{\alpha}{V'}} \cdot \sigma_E$	$\sigma_s = f(\sigma_0)$ <div style="background-color: #e0e0e0; padding: 5px; display: inline-block;">plus bunch manipulation</div>

“virtual” (internal) power

real (external) power

Beam emittance – single pass machine ↔ storage ring

3rd generation light sources in operation (selection):
 ALBA (5 nm@3 GeV), SOLEIL (4 nm@2.7 GeV), DIAMOND (3 nm@3 GeV),
 ESRF (4 nm@6 GeV), APS (3 nm@7 GeV), SPring8 (3nm@8 GeV)
 ALS (2.2 nm@1.9 GeV), PETRAIII (1 nm@6 GeV / **0.16nm@3GeV**)

$$\epsilon = \frac{\epsilon_{\text{norm}}}{\gamma}$$

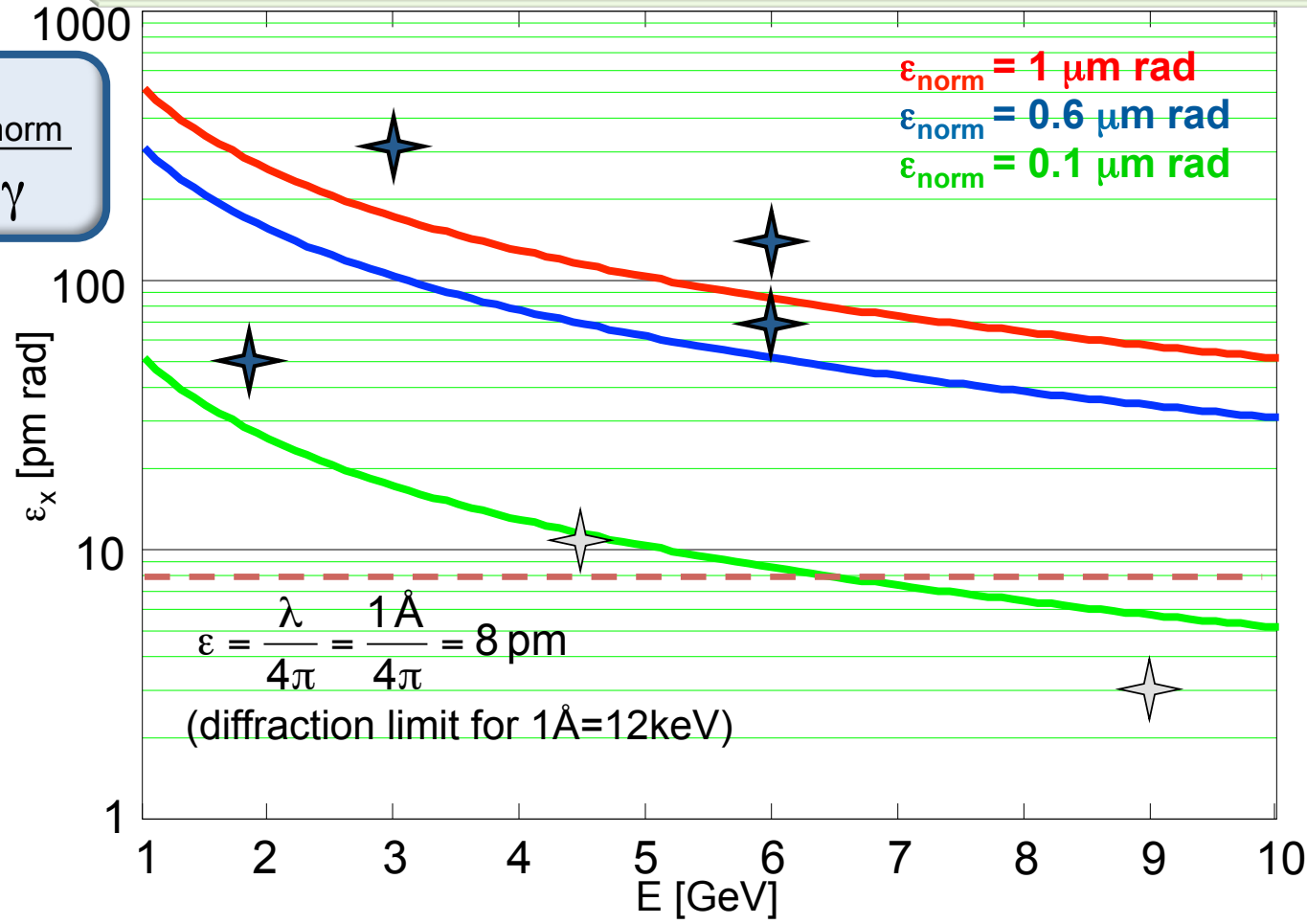

- MBA**
 ultra low emit.
 lattices:
- 320 pm, MAX IV** (in operation)
 - 147 pm, ESRF II** (upgrade 2018 - 2020)
 - 65 pm, APS** (design phase)
 - ~50 pm, ALS-U** (design phase)
 - 11 pm, PEPX** (design study)
 - 3 pm, tUSR** (design study)

Storage rings: low emittance goes hand in hand with necessity to operate with long bunches (up to some 100 ps) to reduce Touschek and IBS scattering!

Energy Recovery Linacs – The idea

- high average („virtual“) beam power (up to A, many GeV)
- many user stations
- beam parameter defined by equilibrium
- typical long bunches (20 ps – 200 ps)

- outstanding beam parameter
- single pass experiments
- high flexibility, short bunches (~ 10 fs)
- low number of user stations
- limited average beam power (\ll mA)

e.g. ESRF:
6 GeV, 200 mA
1.2 GW
virtual power,
stored energy
only 3380 J

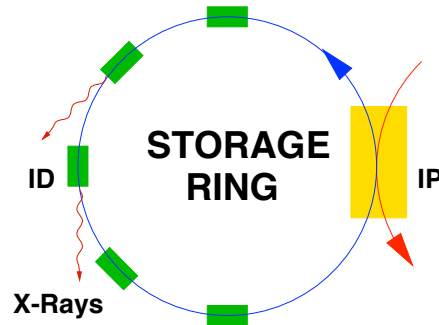

Energy Recovery Linacs – The idea

- high average („virtual“) beam power (up to A, many GeV)
- many user stations
- beam parameter defined by equilibrium
- typical long bunches (20 ps – 200 ps)

- outstanding beam parameter
- single pass experiments
- high flexibility, short bunches (~ 10 fs)
- low number of user stations
- limited average beam power (<<mA)

e.g. ESRF:
6 GeV, 200 mA
1.2 GW
virtual power,
stored energy
only 3380 J

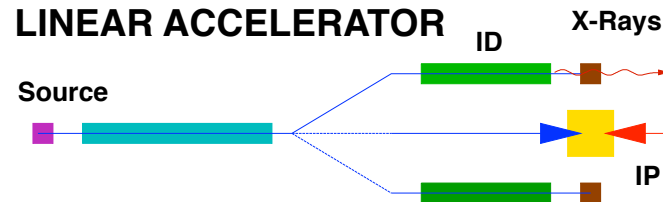
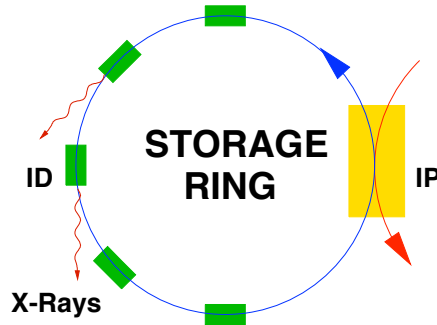

e.g. XFEL:
17.5 GeV, 30 μA
“only” ~ 500 kW,
but real power

$$\epsilon \sim \frac{1}{\gamma} \cdot \epsilon_{\text{source}}$$

**intrinsic short bunches,
high current**

ENERGY RECOVERY LINAC

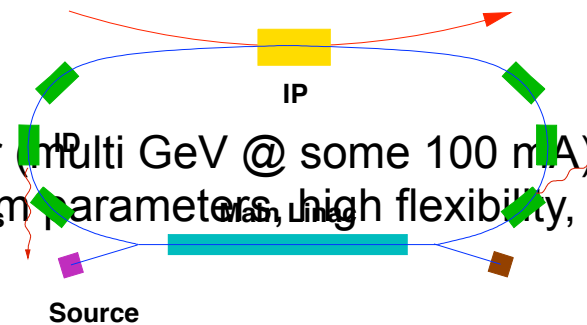

high average beam power (multi GeV @ some 100 mA) for single pass experiments,
excellent beam parameters, high flexibility, multi user facility

Energy recovery (nothing spooky)

e.g. „electron cooler“ for ion beams, first devices in the 70ies

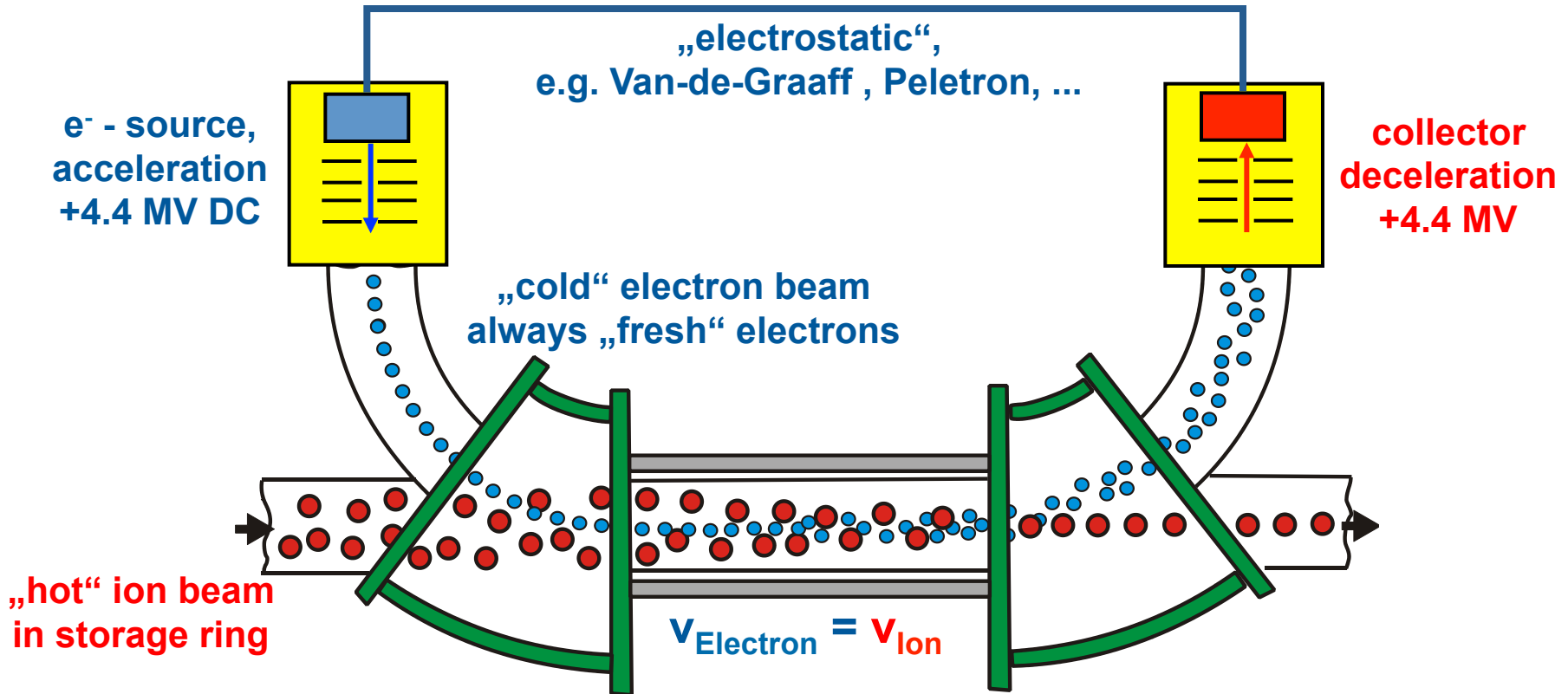

e.g. FermiLab recycler ring (Tevatron)

anti protons:	$E = 9$ GeV	$\rightarrow \beta = 0.995$
electrons:	$E = 4.9$ MeV	$\rightarrow U_{\text{Cooler}} = 4.39$ MV ($\beta = 0.995$)
	$I = 0.5$ A (DC)	$\rightarrow P = 2.2$ MW

„virtual“

Energy recovery in RF-fields – braking the DC limit

RF linear accelerator

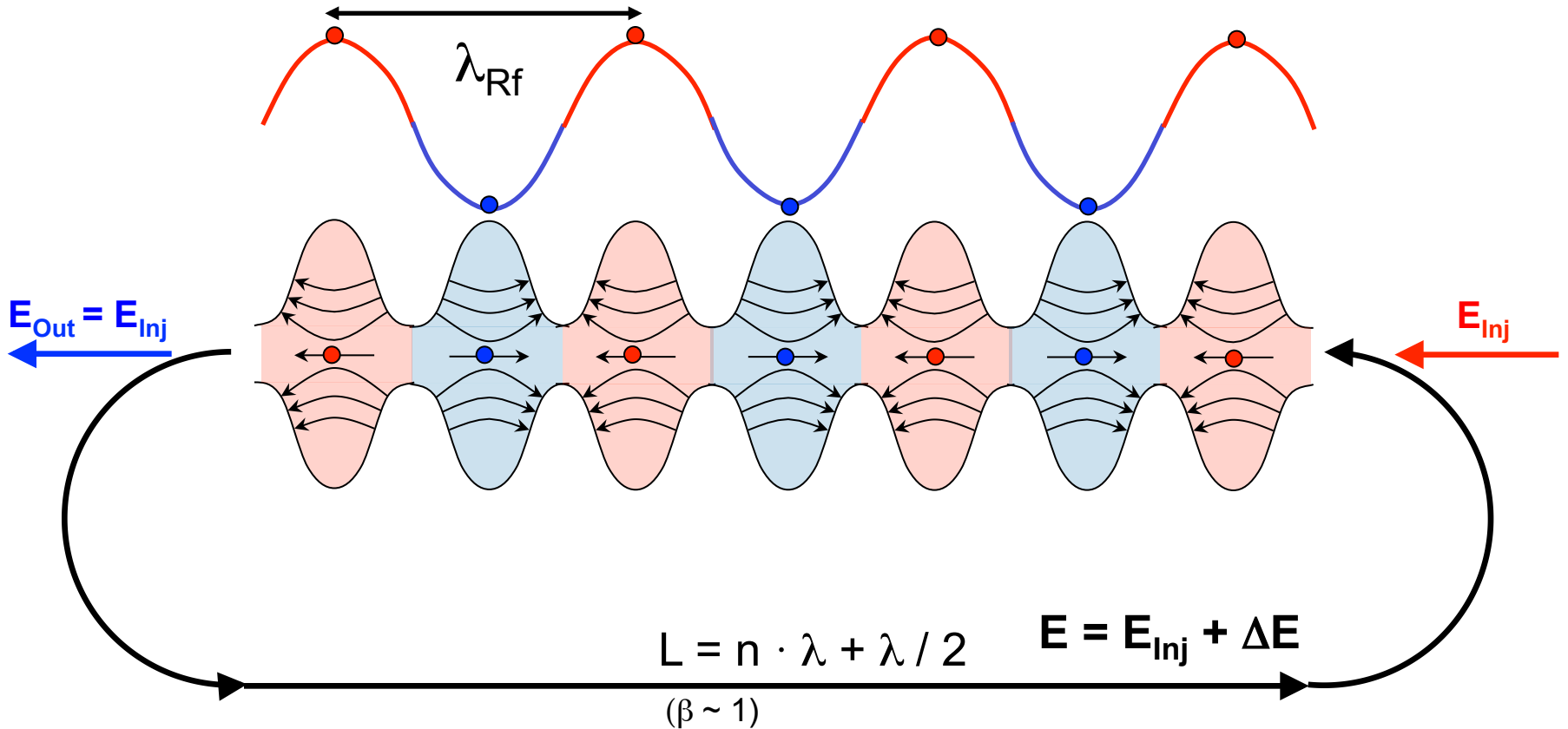

Energy supply = acceleration

→ „loss free“ energy storage (in the beam)

→ Energy recovery = deceleration

The Energy Recovery Linac Principle

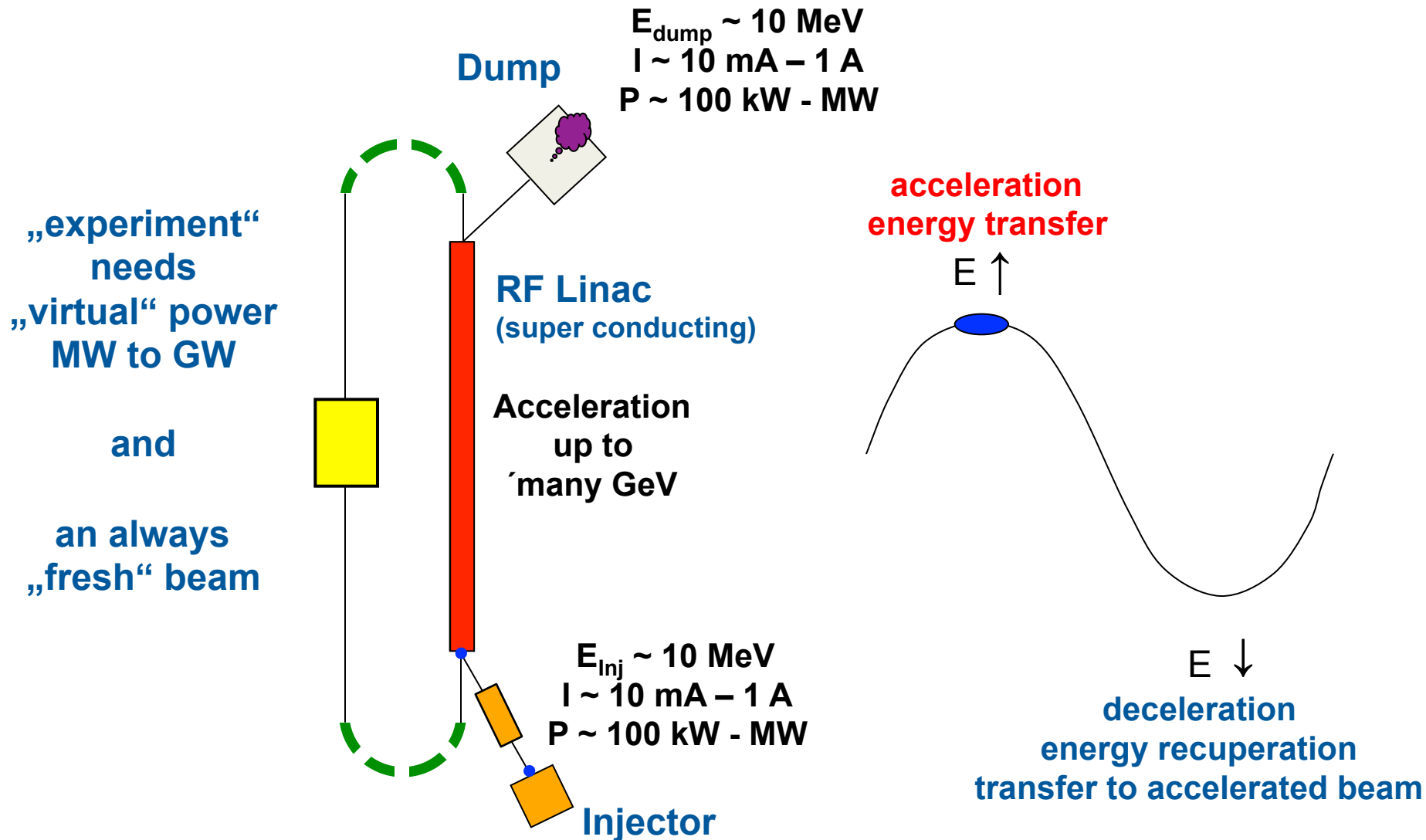

ERLs are in favor of superconducting RF

normal conducting (Cu) RF

(typical S/C-Band, ~2 – 6 GHz)

$\Delta E \sim 1 \text{ MV/m} / P_{\text{RF}} \sim 15 \text{ kW/m (CW)}$

(in short structures 210 kW/m reached = 3.8 MV/m)

pulsed operation allows ~ 50 MV/m, but duty cycle reduced by $1/50^2 = 0.4 \%$

cw high current operation hampered by limited HOM damping capabilities

(efficiency needs long structures with many cells, apertures typical only 10-20mm)

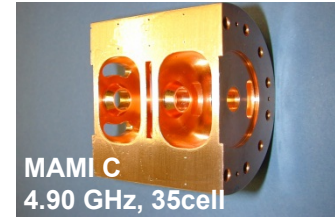

super conducting (Nb) RF

(L-Band, ~ 1 – 2 GHz)

$\Delta E \sim 20 \text{ MV/m} / P_{\text{RF}} \sim 20 \text{ W/m (CW)}$

(JLAB upgrade: 19.2 MV/m)

large apertures (70mm+) and low number of cells allows efficient HOM damping

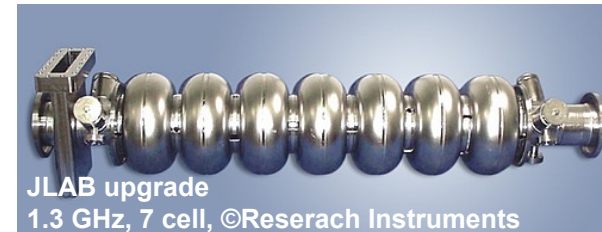

**SC RF allows to built an ERL “compact” (high gradient)
for high current cw operation (large apertures, strong HOM damping)**

Wall plug power consumption shifts from RF to Cryo (2K efficiency ~ 1/1000)

ERL is not necessarily a “green machine”

First idea: M. Tigner, Nuovo Cimento 37 (1965) 1228

Beam energy (GeV)	0.5	3
Length (m)	47	275
Beam current (A)	0.120	0.120
Luminosity ($\text{cm}^{-2} \text{s}^{-1}$)	$3 \cdot 10^{30}$	$3 \cdot 10^{30}$
RF power to establish accelerating field in absence of beam (kW), (1000 MHz operation)	.55	3.3
Refrigerator power (MW)	0.92	5.5
Synchrotron radiation loss in magnets (kW)	—	14 (30 m bending radius)

g-Beam Experiments (*).

rsity - Ithaca, N. Y.

65)

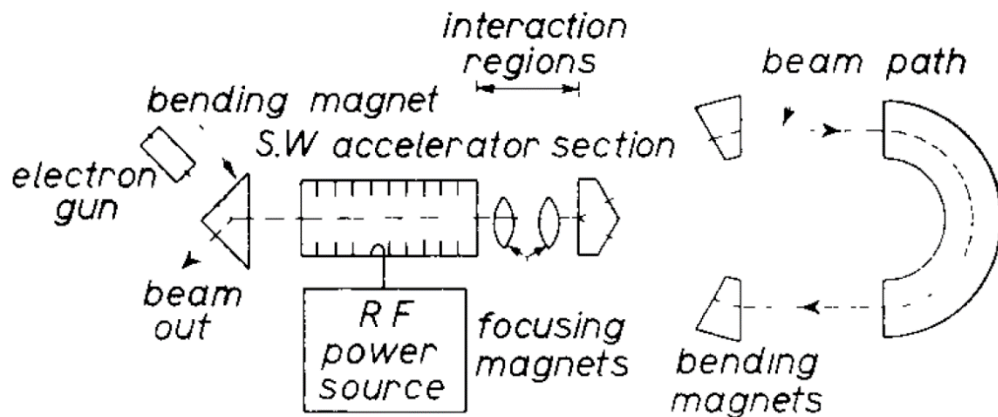

- stability issues (charge) solved
- one linac only

Maybe first realisation
(1977, without taking attention to it):
Reflexotron (two pass linac) for
medical application
(Chalk River, Canada)

S.O. Schreiber, IEEE NS-22 (1975) (3) 1060-1064

History – The Chalk River Reflexotron

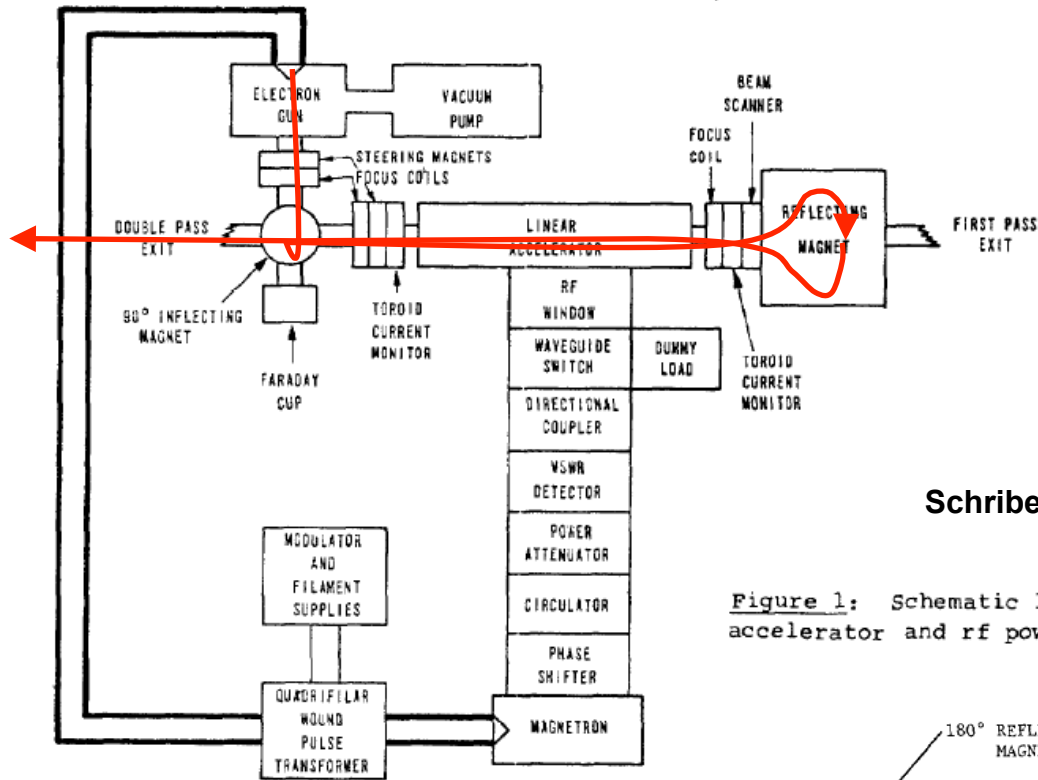

Schriber, Funk, Hodge, Huchon, PAC1977, 1061-1063

Figure 1: Schematic layout of accelerator and rf power system.

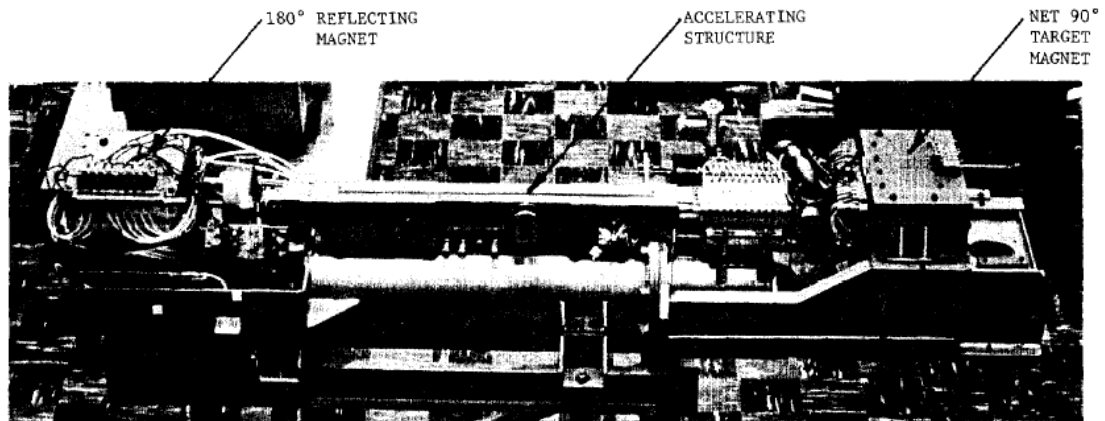
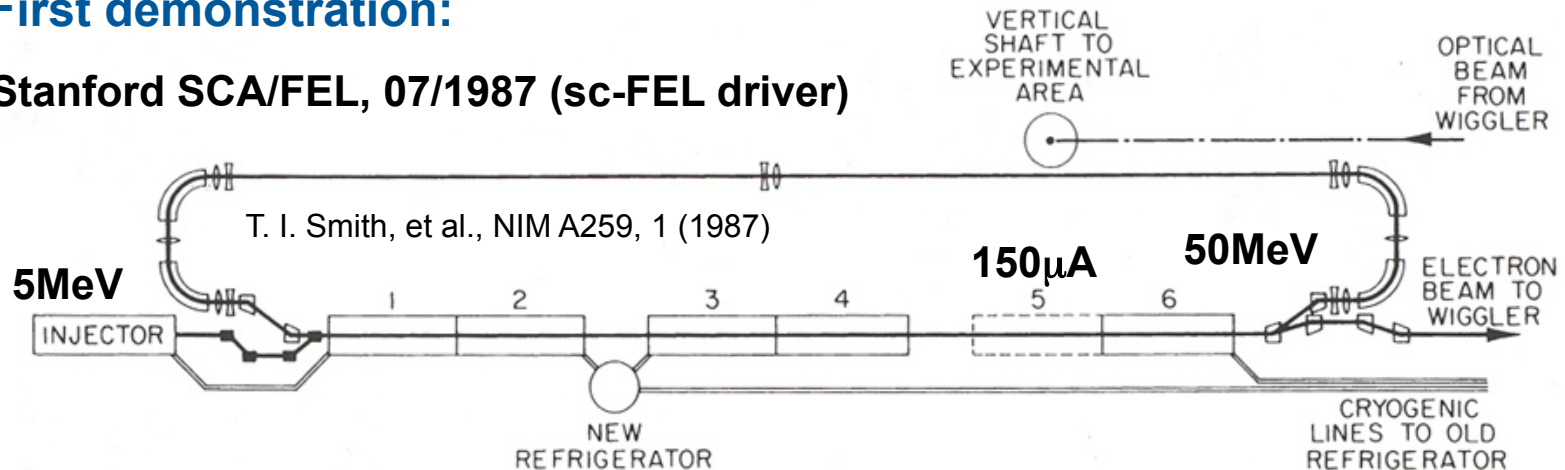

Figure 1. The 25 MeV electron accelerator attached to its strongback.

History – First demonstration

First demonstration:

Stanford SCA/FEL, 07/1987 (sc-FEL driver)



MIT Bates Recirculated Linac (2.857GHz, nc, pulsed), 1985

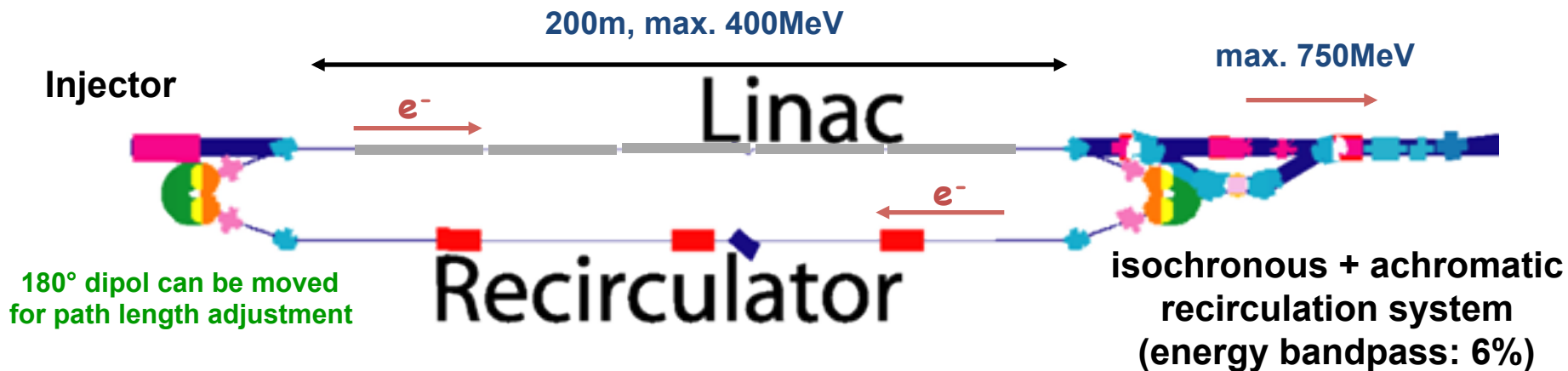

J.B. Flanz et al., IEEE Trans. Nucl. Sci., NS-32, No.5, p.3213 (1985)

History – A Little Different Concept

D.W. Feldman et al. / Energy recovery in the Los Alamos FEL

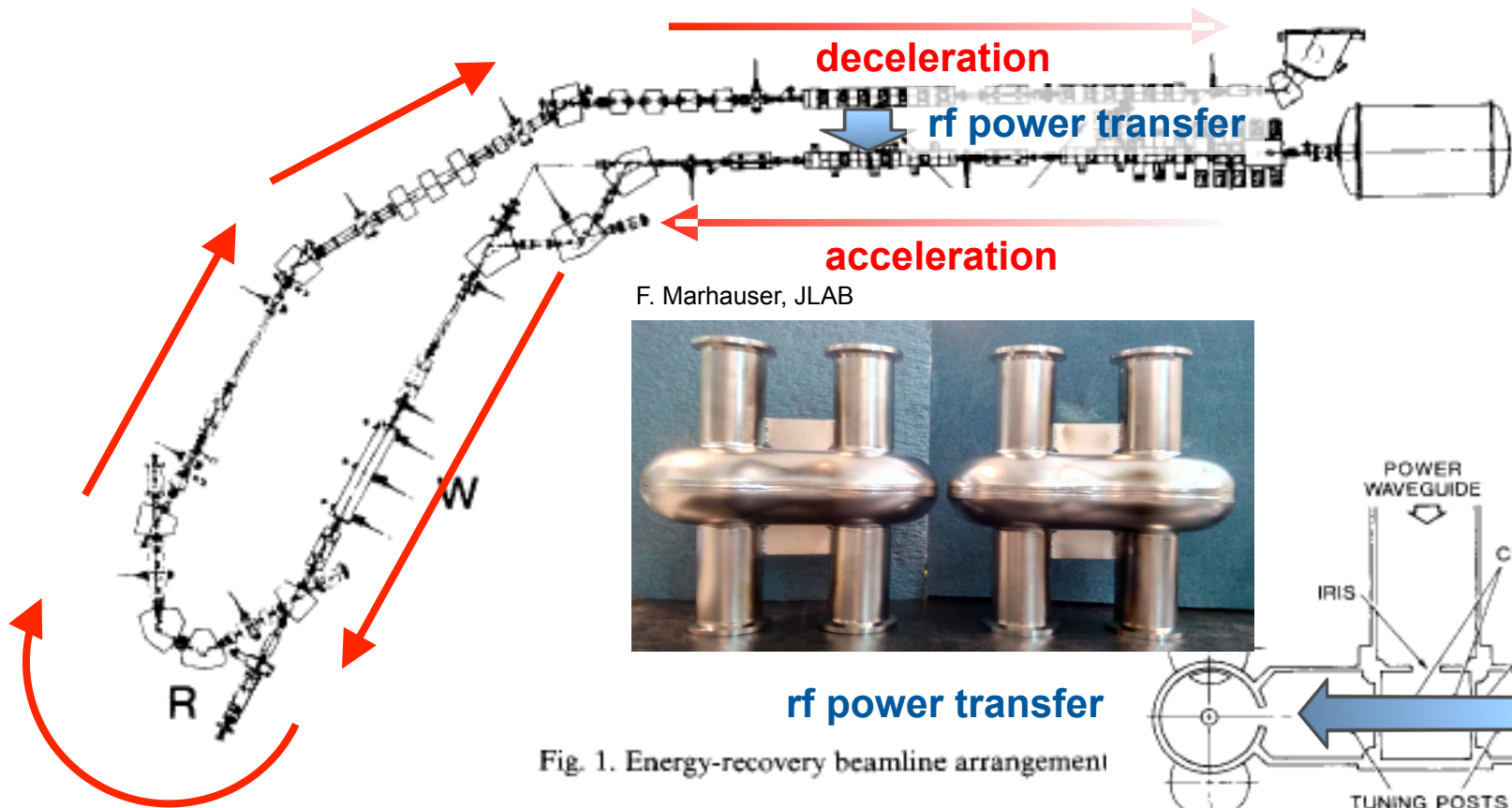

F. Marhauser, JLAB



rf power transfer

Fig. 1. Energy-recovery beamline arrangement

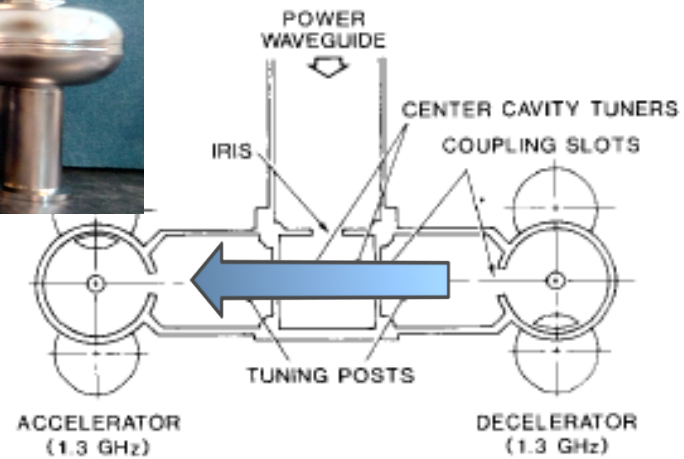
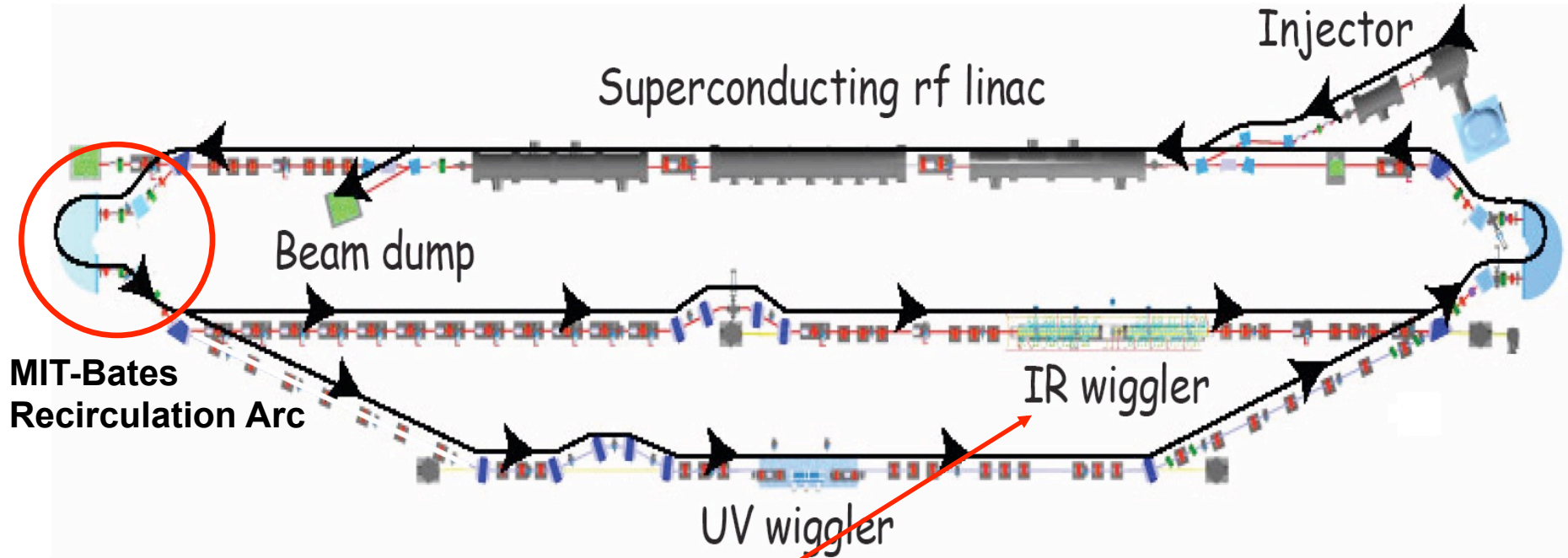

Fig. 2. Resonant bridge-coupler cross section.

First facilities – JLAB FEL

G.R. Neil, et al., Nucl. Instr. & Methods **A557** (2006) 9.



MIT-Bates
Recirculation Arc

**up to 14 kW cw laser power
@ 1.6 μm wavelength**

Parameter achieved:

Energy: 160 MeV

Current: 9.1 mA

(135 pC @ 75 MHz)

beam power: 1.5 MW

emittance (norm.): 7 μm

min. pulse length: 150 fs

First facilities – KEK / JAEA ERL FEL

JAEA IR-FEL (starts 1987, JAERI):

**500 MHz sc cavities, 15 – 20 MeV, 8 mA → 2 kW cw laser power @ 22 μm
at the beginning single pass → 2002 upgrade to energy recovery setup**

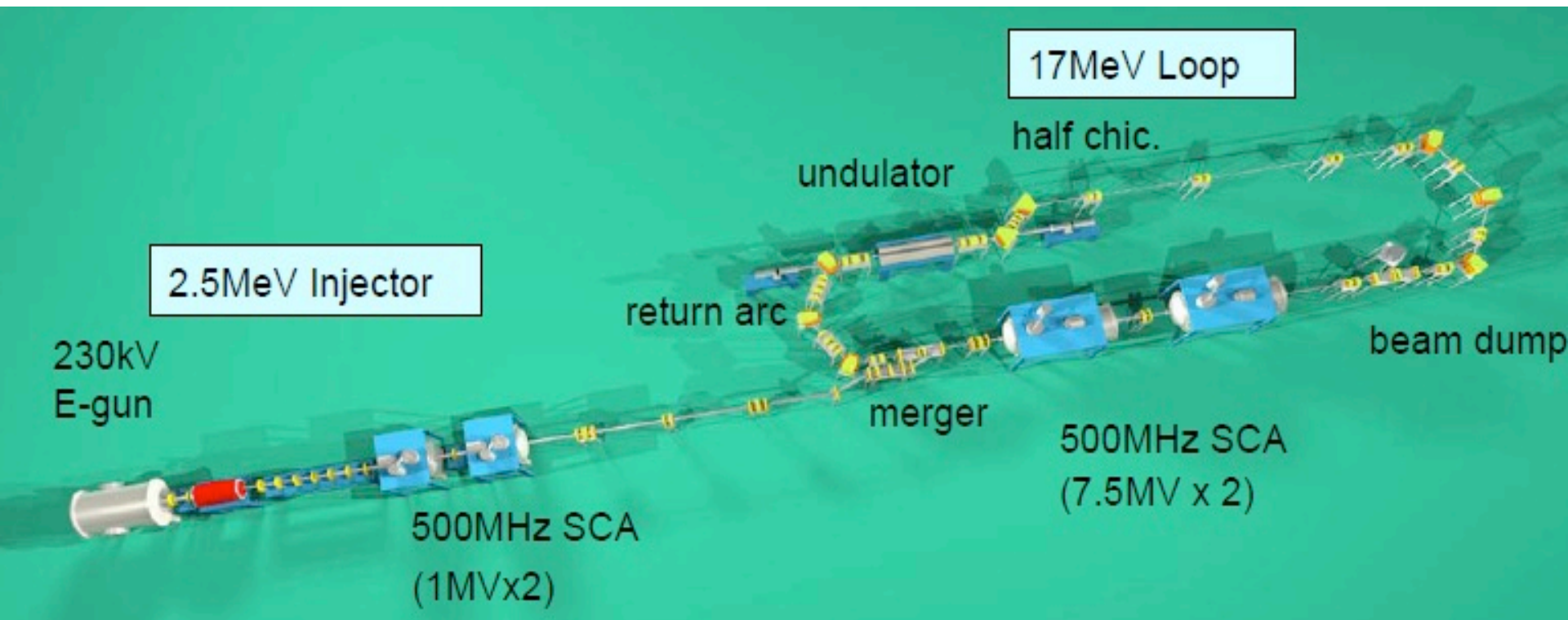

**Around 2005: KEK and JAEA proposes ERL based light sources (5 GeV)
Decision to built in an common effort: Compact ERL !**

Overview on projects and facilities

First idea:
M. Tigner (1965)

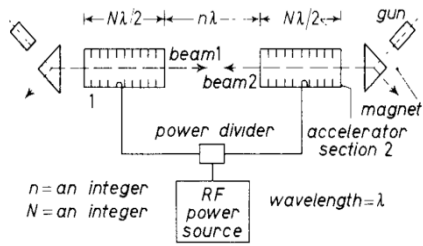

1960

BINP FEL (2004):
First multi-turn ERL

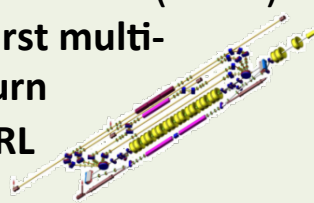

JAERI FEL (2002):
17 MeV, 5 mA

1980

CBETA (2016)
FFAG ERL
(with BNL)

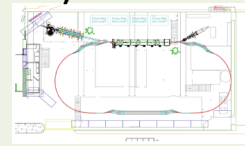

Cornell University
Injector Teststand

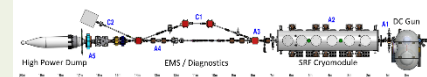

2000

BNL R&D ERL
Beijing ERL-FEL



bERLinPro

2020

ALICE, Daresbury

PERLE@ORSAY (?)
CERN, JLAB, Daresbury, BINP, LAL

First energy recovery:
Stanford SCA/FEL (1987)

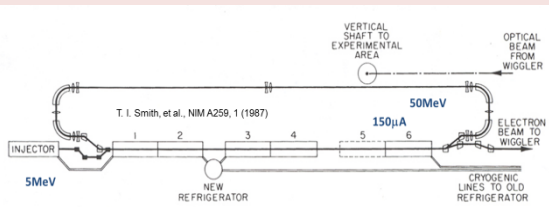

JLAB-FEL: Demo-FEL (1999)
& FEL Upgrade (2004)

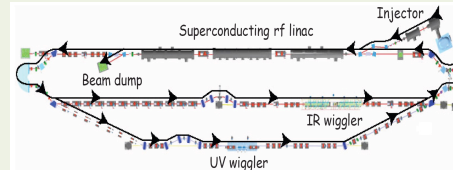

KEK cERL (2014):
recirc. & energy recovery

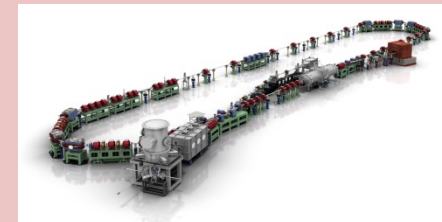

ERL as next Generation Multi-GeV, Multi-User SR-Source

Combines the two worlds of storage rings and linacs

- with energy recovery: some 100mA @ many GeV possible
- always “fresh” electrons (no equilibrium)
 - small emittance ($\sim 0.1 \mu\text{m rad norm.} = 10 \text{ pm rad@6GeV}$)
 - high brilliance (x 100 – 1000 compared to SR)
 - short pulses (ps down to 10 – 100 fs)
- free choice of polarisation
- 100% coherence up to hard X-rays
- real multi-user operation at many beam lines
- tailored optics at each ID

+

Flexible modes of operation (high brilliance, short pulse, different pulse patterns)
adaptable to user requirements!

Cornell ERL

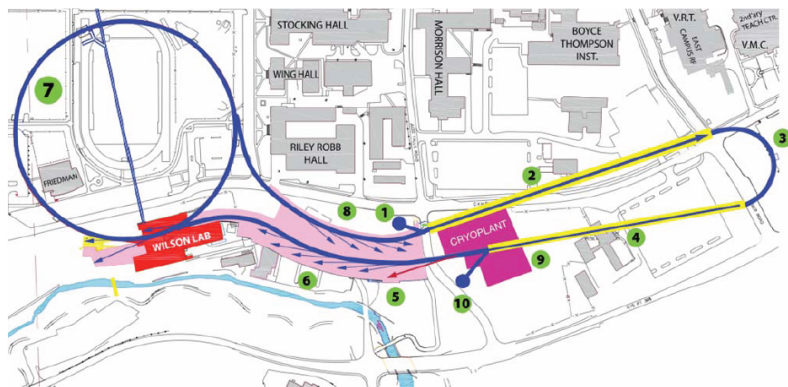

5 GeV, 100mA, $\epsilon = 8$ pm rad

($\epsilon_{\text{norm}} = 0.08 \mu\text{m}$ (@77pC), 2ps)

KEK ERL

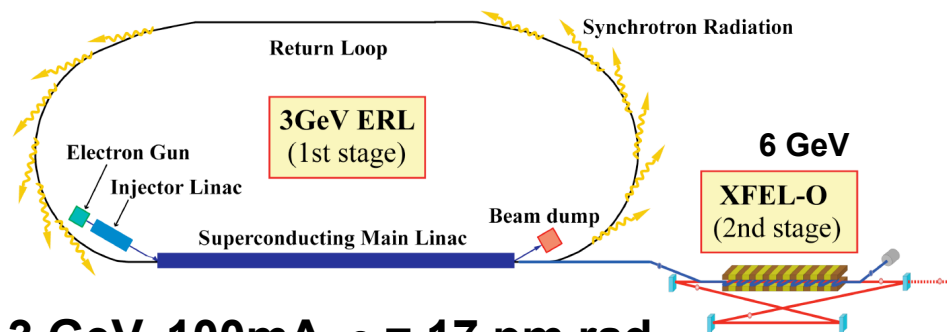

3 GeV, 100mA, $\epsilon = 17$ pm rad

($\epsilon_{\text{norm}} = 0.1 \mu\text{m}$ (@77pC), 2ps)

Femto Science Facility (FSF)

(multi turn, split linac), A. Matveenko et al.

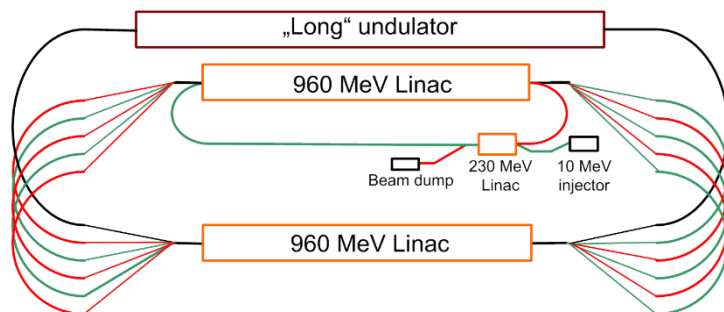

6 GeV, 20/5 mA, $\epsilon = 8/40$ pm rad

($\epsilon_{\text{norm}} = 0.1/0.5 \mu\text{m}$ (@15/4 pC), < 1 ps / 10 fs)

ELR as electron part of Electron Ion Collider

e.g. eRHIC: addition of an ERL to RHIC / BNL = Electron Ion Collider

250 GeV polarised protons \leftrightarrow 20 GeV polarised electrons, $L=10^{33-34} \text{ cm}^{-2} \text{ s}^{-1}$
 (415 mA) (10 mA) ($\beta^*=5\text{cm}$, $6\mu\text{m}$ spot size @ IP)

ERL compared to storage ring

- electron beam needs to pass the interaction zone only once
- disturbance of electron beam by proton beam can be up to 20x stronger
 - higher number of protons with high density possible
 → drastic increase in luminosity
 - higher flexibility in interaction region design
- spin transparency (free choice to arrange spin orientation at IP)

Why ERL and not storage ring?

Luminosity

$$L = f_{\text{coll}} \cdot \frac{n_{\text{lon}} \cdot n_e}{4 \cdot \pi \cdot \epsilon \cdot \beta} \cdot F_{\text{HGR}}$$

Limit: beam-beam parameter electrons (!)

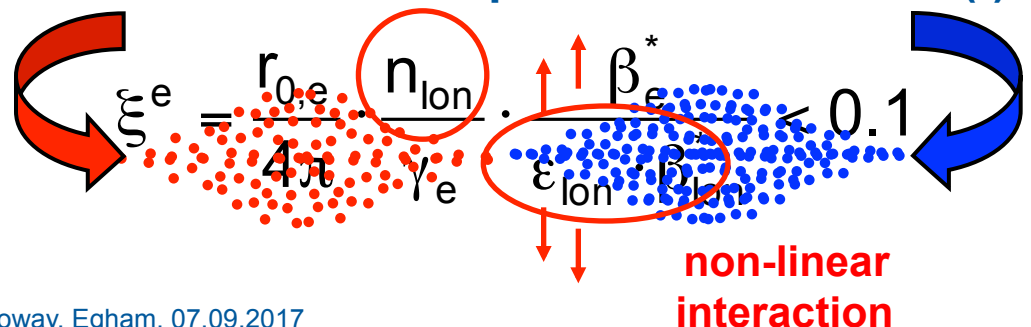

ELR as electron part of Electron Ion Collider

60 GeV (e) x 7 TeV (p)

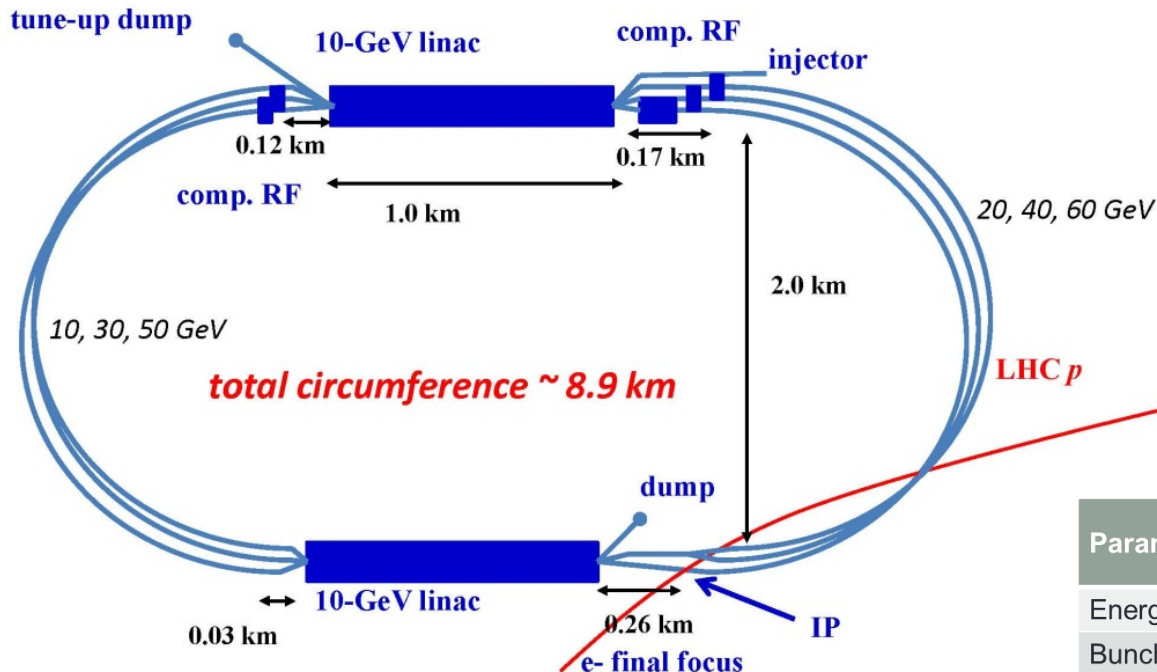

Parameters	LHeC	
	e	p
Energy (GeV)	60	7000
Bunch spacing (ns)	25	
Intensity, 10^{11}	0.01	1.7
Current (mA)	6.4	860
rms norm. emit. (mm-mrad)	50	3.75
$\beta_{x/y}^*$ (cm)	12	10
rms bunch length (cm)	0.06	7.6
IP rms spot size (μm)	7.2	
Beam-beam parameter		0.0001
Disruption parameter	6	
Polarization, %	90	None
Luminosity, $10^{33}\text{cm}^{-2}\text{s}^{-1}$	1.3	

ELR as electron cooler



e.g. RHIC
Cooling of 100GeV/u Au

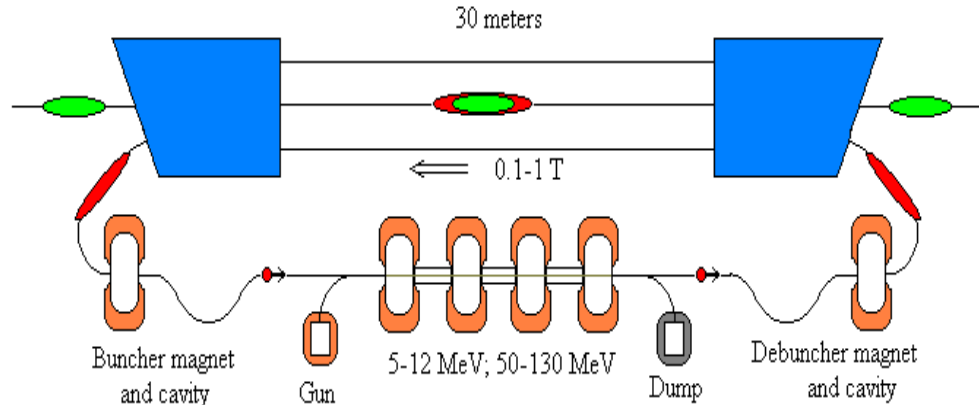

Efficient cooling needs

- $\gamma_{ion} = \gamma_{electron}$, e.g. 100 GeV protons needs 54.5 MeV electrons
- low emittance of electron beam ($\epsilon_{norm} \sim \mu\text{m rad}$)
- low energy spread of electron beam ($\delta_{E,rel} \sim 0.05\%$)
- high electron beam current

54.5 MV and A class currents not feasible with electrostatic accelerators

ERL cooler needs overlap of (many “short”) electron bunches with (“long”) ion bunches

(LEReC Phase-I project@BNL, up to 2 MeV, gun2dump approved)

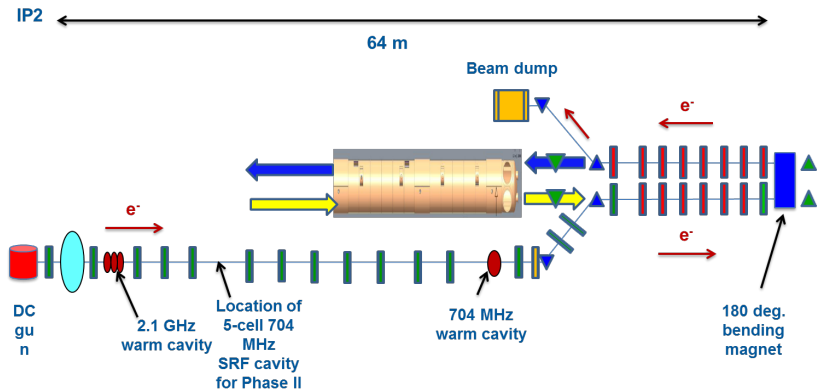

for ultra high ion energies
Coherent Electron Cooling
 (“stochastic cooling”)

- ion beam imprints modulation on electron beam
- modulation on electron beam amplified by FEL
- electron beam acts back on ion beam

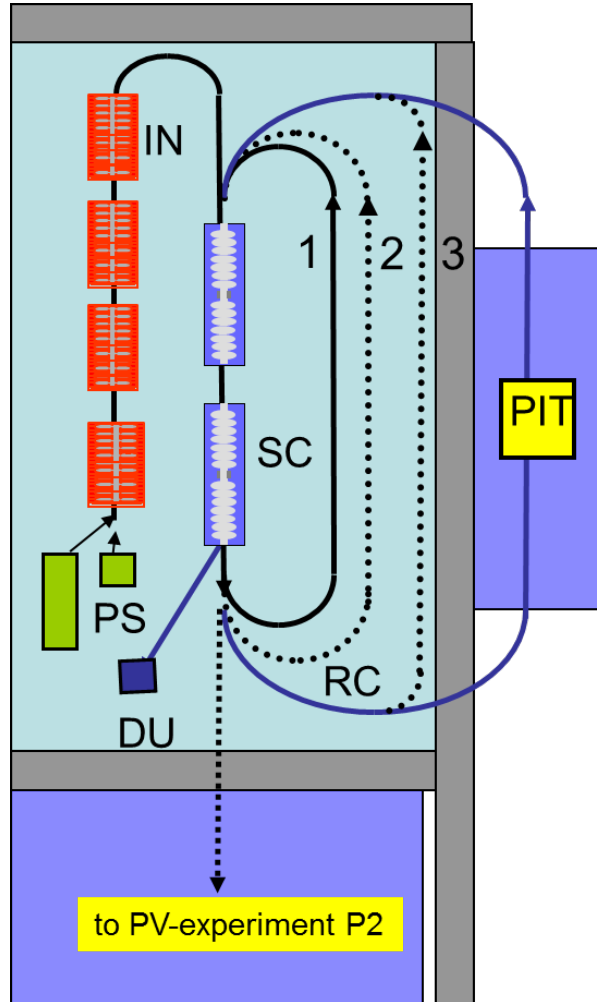

MESA @ Mainz University

Multi turn ERL for

- 1) External beams for precision measurements (weak mixing angle)

$E=155 \text{ MeV @ } 150 \mu\text{A}$, polarized e^- , $L=10^{39} \text{ cm}^{-2} \text{ s}^{-1}$

- 2) Pseudo Internal Target (PIT) experiments in Energy Recovery mode (dark photon search)

$E=105 \text{ MeV @ } 1 \text{ mA (10mA)}$, $L=10^{35} \text{ cm}^{-2} \text{ s}^{-1}$

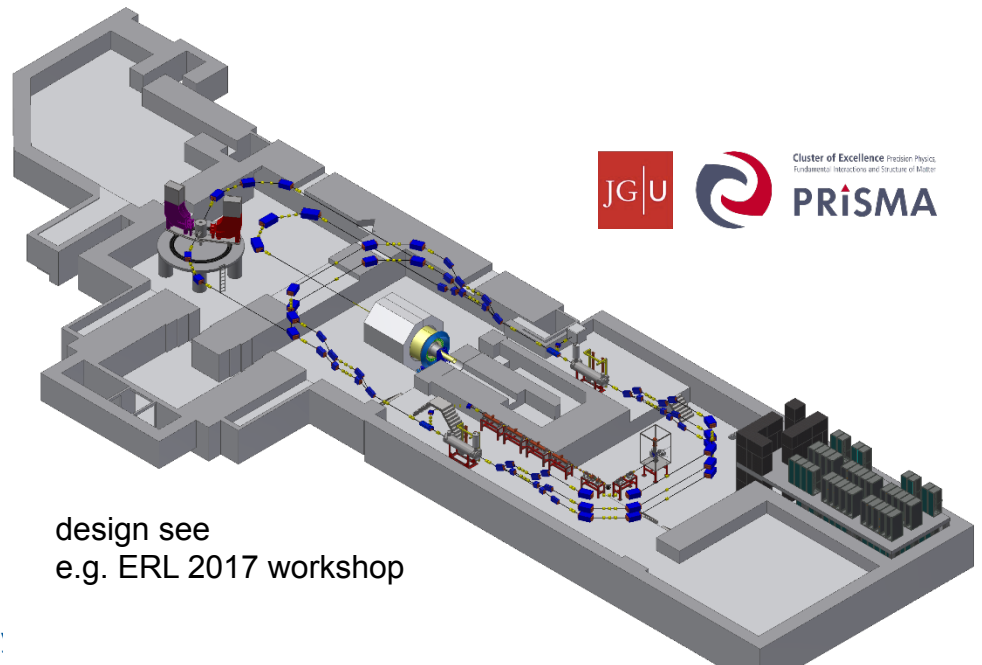

Cluster of Excellence Precision Physics
Fundamental Interactions and Structure of Matter

design see
e.g. ERL 2017 workshop

Next generation multi-user light source

(diffraction limited, short pulses, ID tailored beam parameters)

High energy electron cooling of bunched proton/ion beams

(Energy ~ 100 MeV + high current \rightarrow rules out VdG or SR)

Ultra high luminosity electron – ion collider (EIC, LHeC)

(overcoming beam-beam effect electron ring)

Compact radiation sources

(FEL, Compton sources,
next generation lithography)

and more ...

Electron source:

high current, low emittance (100 mA – A cw with $\epsilon_{\text{norm}} < \mu\text{m rad}$) not yet demonstrated
(big step forward: Cornell's 80 mA, dc gun)

Injector/Booster:

100 mA @ 5 – 15 MeV = 500 – 1500 kW beam loading (coupler, HOM damper, beam dump)

Main-Linac:

100 mA recirculating beam → beam break up (BBU), higher order modes (HOM),
highest cw-gradients (>15 MV/m) with quality factor $> 10^{10}$ → reduce cryo costs

Beam dynamics / optics:

recirculation, flexible optics, bunch compression schemes = flexibility

Control of beam loss

unwanted beam = dark current from cathode, gun, cavities due to field emission, stray light laser
beam halo, collimation schemes !?

Storage ring:

nearly Gaussian
~ pA losses typical
~ 10 nA maximum

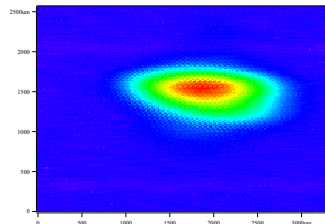

ERL:

no dead mathematician
~ 100 μA losses possible

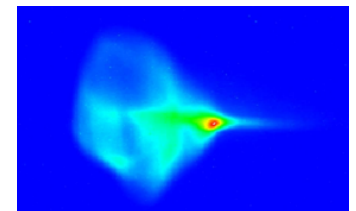

The “hummingbird”
P. Evtushenko, JLAB

Comparison Storage Ring <-> ERL (used charge / losses)

Let us assume 6000h/a operation @ 1.7 GeV

ERL parameter:

(10 MeV dump energy, 10^{-6} loss rate)

$$I_{\text{Beam}} = 100 \text{ mA}$$

$$\rightarrow 0.1 \text{ C / s}$$

$$\rightarrow 2.2 \cdot 10^6 \text{ C / a} = 1.4 \cdot 10^{25} \text{ electrons / a}$$

assume a lossrate of 10^{-6}

99.9999 mA dumped @ 10 MeV = 1 MW
(easily shielded, as mostly Gammas and
no neutrons)

100 nA dumped @ 1.7 GeV = 170 W

$$\rightarrow 100 \text{ nC / s}$$

$$\rightarrow 2.16 \text{ C / a} = 1.34 \cdot 10^{19} \text{ electrons / a}$$

BESSY II parameter (adjusted for comparison):

($\tau = 15 \text{ h}$ beam lifetime, $\eta_{\text{inj.}} = 90\%$ injection eff.,
 $T_{\text{circ}} = 800 \text{ ns}$)

$$I_{\text{Beam}} = 100 \text{ mA}$$

$$\rightarrow Q_{\text{Beam}} = 80 \text{ nC circulating "forever"}$$

$$\rightarrow 80 \text{ nC} = 0.5 \cdot 10^{12} \text{ electrons "forever"}$$

$$I(t) = I_0 \cdot e^{-\frac{t}{\tau}}, \quad Q(t) = Q_0 \cdot e^{-\frac{t}{\tau}}$$

$$\dot{Q}(t=0) = -\frac{Q_0}{\tau}, \quad Q_{\text{loss}} / \text{s} = \frac{\dot{Q}}{\eta_{\text{eff}}} = \frac{Q_0}{\eta_{\text{eff}} \cdot \tau}$$

losses are governed by lifetime and injection

maintaining $I_{\text{Beam}} = 100 \text{ mA} / Q_{\text{Beam}} = 80 \text{ nC}$

$$\rightarrow 1.65 \text{ pC / s}$$

1.65 pA dumped @ 1.7 GeV = 0,0028 W

$$\rightarrow 1.65 \text{ pC / s}$$

$$\rightarrow 35.6 \text{ } \mu\text{C / a} = 2.2 \cdot 10^{14} \text{ electrons / a}$$

Comparison Storage Ring <-> ERL (used charge / losses)

Let us assume 6000h/a operation @ 1.7 GeV

ERL parameter:

(10 MeV dump energy, 10^{-6} loss rate)

$$I_{\text{Beam}} = 100 \text{ mA}$$

$$\rightarrow 0.1 \text{ C / s}$$

$$\rightarrow 2.2 \cdot 10^6 \text{ C / a} = 1.4 \cdot 10^{25} \text{ electrons / a}$$

assume a lossrate of 10^{-6}

99.9999 mA dumped @ 10 MeV = 1 MW
(easily shielded, as mostly Gammas and
no neutrons)

100 nA dumped @ 1.7 GeV = 170 W

$$\rightarrow 100 \text{ nC / s}$$

$$\rightarrow 2.16 \text{ C / a} = 1.34 \cdot 10^{19} \text{ electrons / a}$$

BESSY II operation parameter:

($\tau = 5 \text{ h}$ beam lifetime, $\eta_{\text{inj.}} = 90\%$ injection eff.,
 $T_{\text{circ}} = 800 \text{ ns}$)

$I_{\text{Beam}} = 300 \text{ mA}$

$\rightarrow Q_{\text{Beam}} = 240 \text{ nC}$ circulating forever

$\rightarrow 240 \text{ nC} = 1.5 \cdot 10^{12}$ electrons forever

$$I(t) = I_0 \cdot e^{-\frac{t}{\tau}}, \quad Q(t) = Q_0 \cdot e^{-\frac{t}{\tau}}$$

$$\dot{Q}(t=0) = -\frac{Q_0}{\tau}, \quad Q_{\text{loss}} / \text{s} = \frac{\dot{Q}}{\eta_{\text{eff}}} = \frac{Q_0}{\eta_{\text{eff}} \cdot \tau}$$

losses are governed by lifetime and injection

maintaining $I_{\text{Beam}} = 300 \text{ mA} / Q_{\text{Beam}} = 240 \text{ nC}$

$\rightarrow 13.3 \text{ pC / s}$

15 pA dumped @ 1.7 GeV = 0,025 W

$$\rightarrow 15 \text{ pC / s}$$

$$\rightarrow 320 \text{ } \mu\text{C / a} = 2 \cdot 10^{15} \text{ electrons / a}$$

bERLinPro – Berlin Energy Recovery Linac Project

bERLinPro = Berlin Energy Recovery Linac Project

100 mA / low emittance technology demonstrator (covering key aspects of large scale ERL)

test and diagnostic line

(5mA@10MeV dump,
energy & slice diag.)

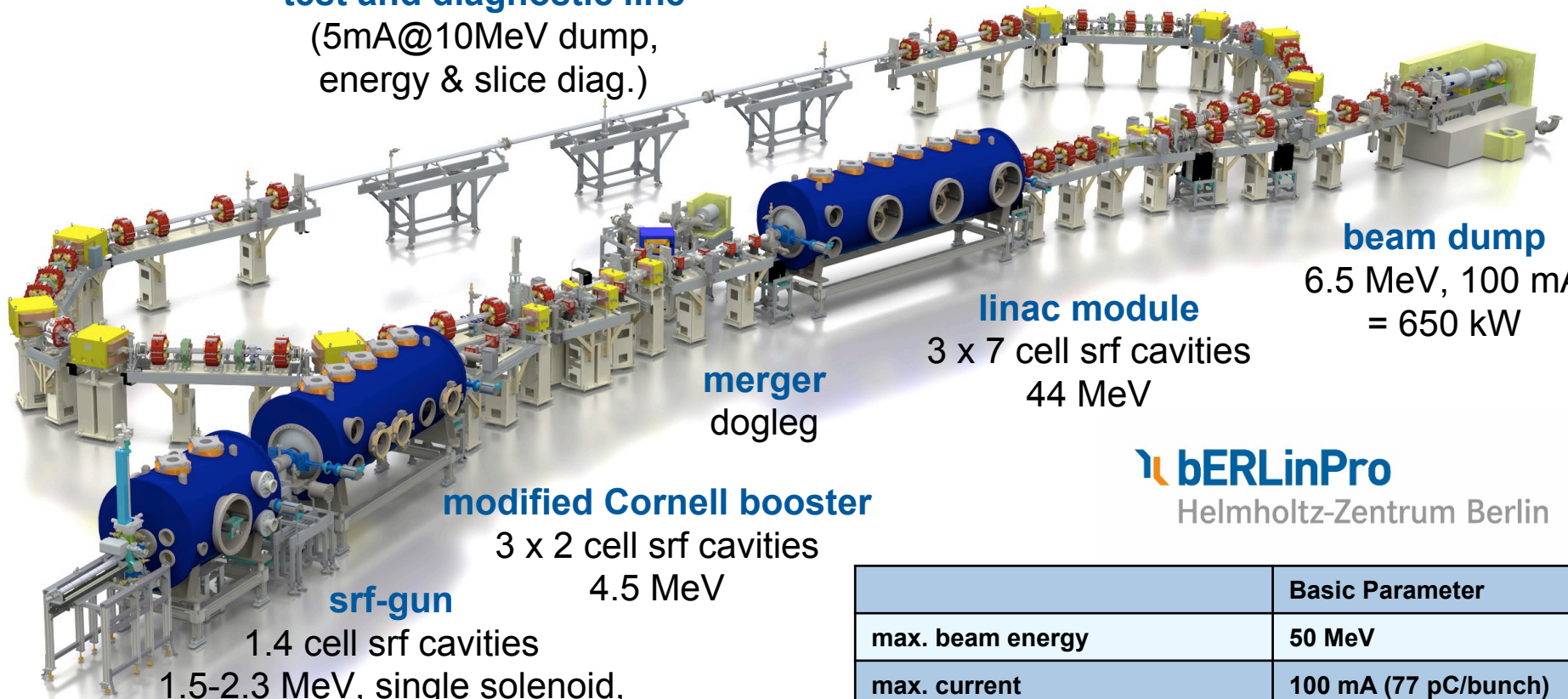

beam dump

6.5 MeV, 100 mA
= 650 kW

linac module

3 x 7 cell srf cavities
44 MeV

**merger
dogleg**

modified Cornell booster

3 x 2 cell srf cavities
4.5 MeV

srf-gun

1.4 cell srf cavities
1.5-2.3 MeV, single solenoid,

bERLinPro

Helmholtz-Zentrum Berlin

project started 2011, fully funded
building ready 2017
first electrons 2018
recirculation 2019/2020

	Basic Parameter
max. beam energy	50 MeV
max. current	100 mA (77 pC/bunch)
normalized emittance	1 μm (0.5 μm)
bunch length (straight)	2 ps or smaller (100 fs)
rep. rate	1.3 GHz
losses	< 10 ⁻⁵

High current, GeV range ERLs

- massive virtual (x 100 MW) and real (x 100 kW) power
 - RF generator & amplifier, RF control: transient beam loading
 - 3 x 270 kW klystron based cw transmitter / 600 kW wall plug power



High current, GeV range ERLs

- massive virtual (x 100 MW) and real (x 100 kW) power
 - RF generator & amplifier, RF control: transient beam loading
- high current source
 - nc (Cornell: 80 mA DC-gun (2014)) vs. sc (Elbe/HZDR, bERLinPro/HZB, BNL)
 - cathode: material, handling & insertion, QE, lifetime, ...
 - laser: power, wavelength, pattern, ...

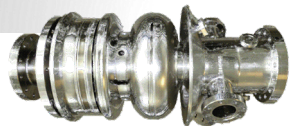
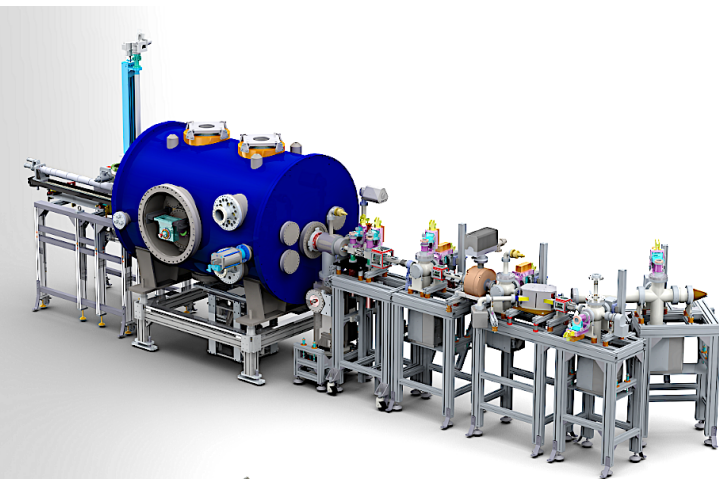

1.4-cell SRF injector

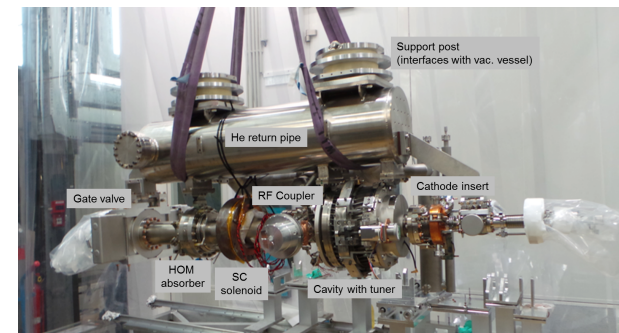
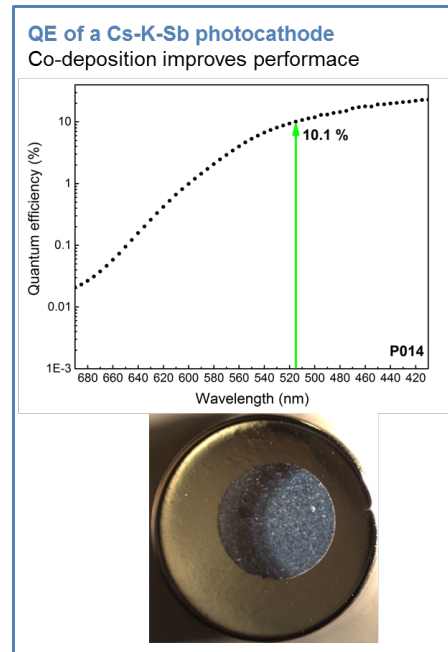

bERLinPro – Technological challenges I

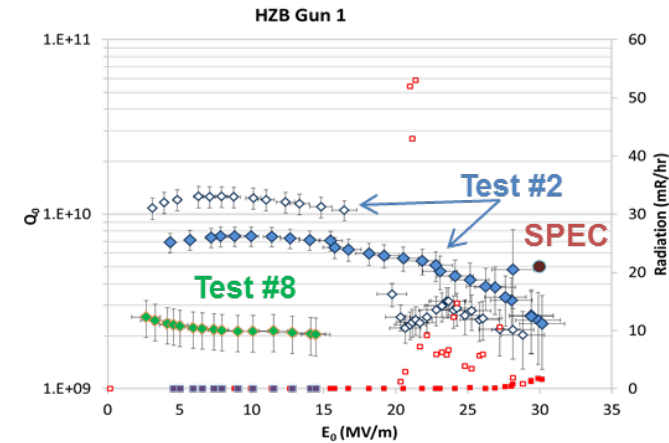
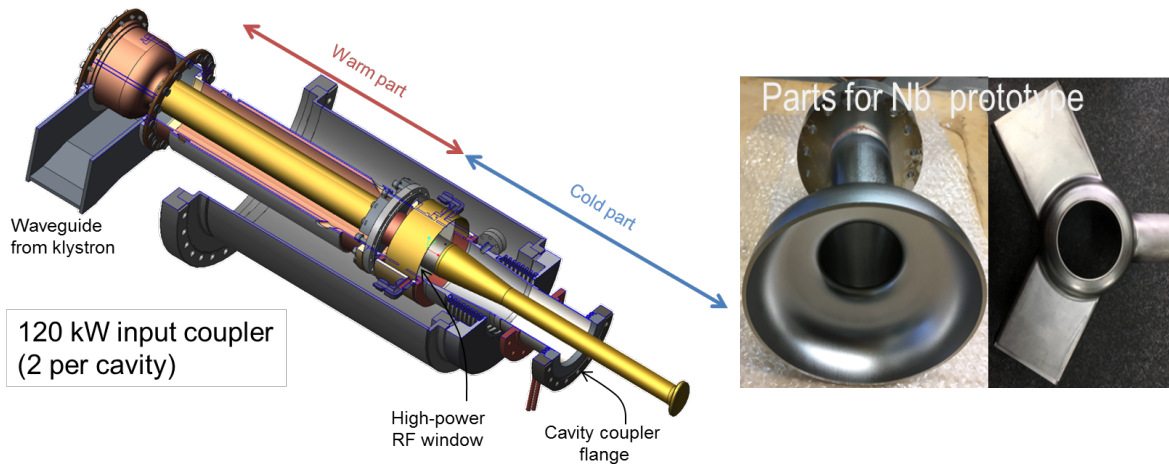

■ sc technology

- high fields / gradients, high Q(uality)
- fieldemission (dark current), multipacting
- cavity treatment (forming & welding, HPR, ECP, BCP, ..), module assembly (clean room, ...)
- high power coupler

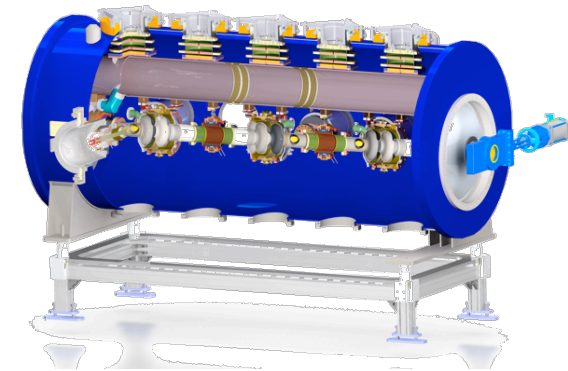

High current, GeV range ERLs

- massive virtual (x 100 MW) and real (x 100 kW) power
 - RF generator & amplifier, RF control: transient beam loading
- high current source
 - nc (Cornell: 80 mA DC-gun (2014)) vs. sc (Elbe/HZDR, bERLinPro/HZB, BNL)
 - cathode: material, handling & insertion, QE, lifetime, ...
 - laser: power, wavelength, pattern, ...
- sc technology
 - high fields / gradients, high Q(uality)
 - fieldemission (dark current), multipacting
 - cavity treatment (forming & welding, HPR, ECP, BCP, ..), module assembly (clean room, ...)
 - high power coupler
- radiation & machine safety
 - fast MPS
 - high power beam dump

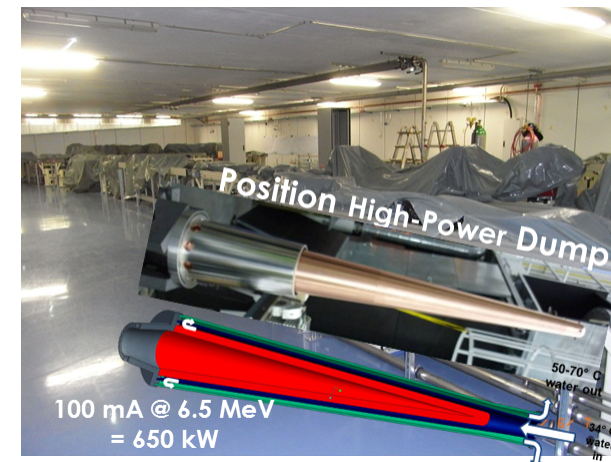

Booster cavities and module are based on the Cornell design
(3 x 2 cell, 1.8 K, 4 MeV@100 mA = 400 kW real beam power, 2 x 230 kW klystron)

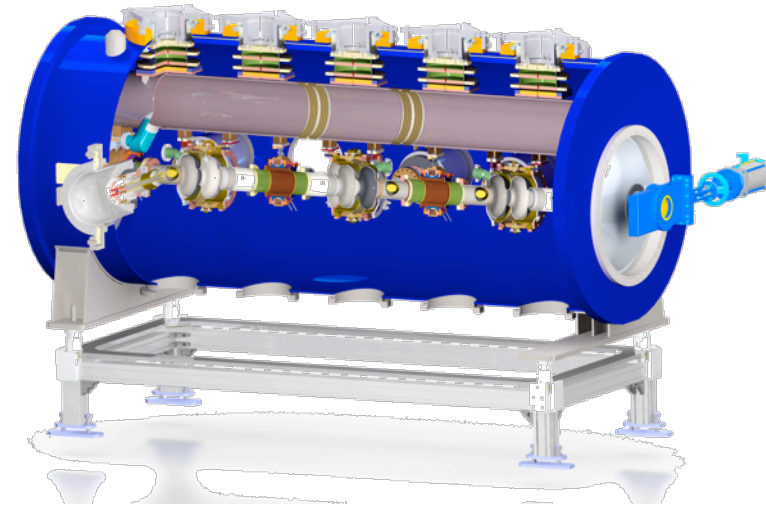
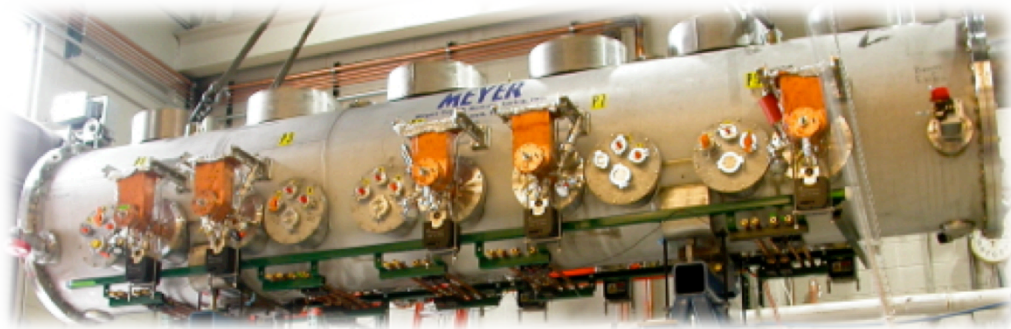

Linac cavities and module (HZB design)
(3 x 7 cell, 1.8 K, 44 MeV@2x100 mA, zero net beam-loading, 3 x 10 kW SSA)

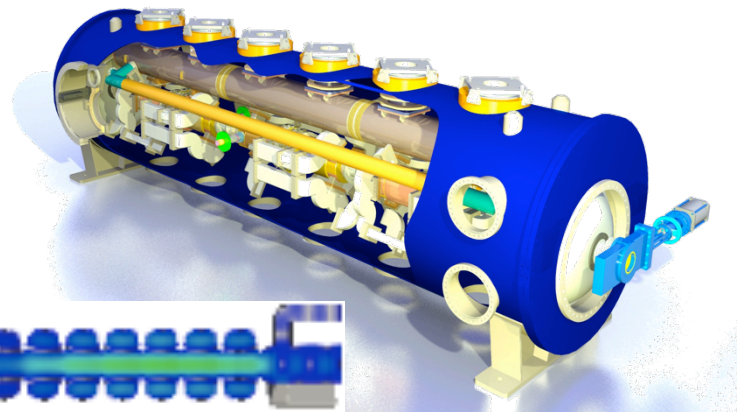
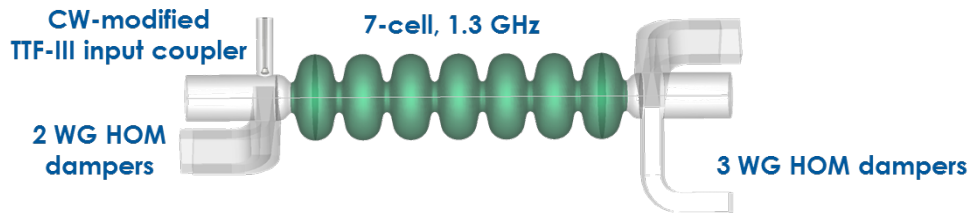



From an artists view to ...

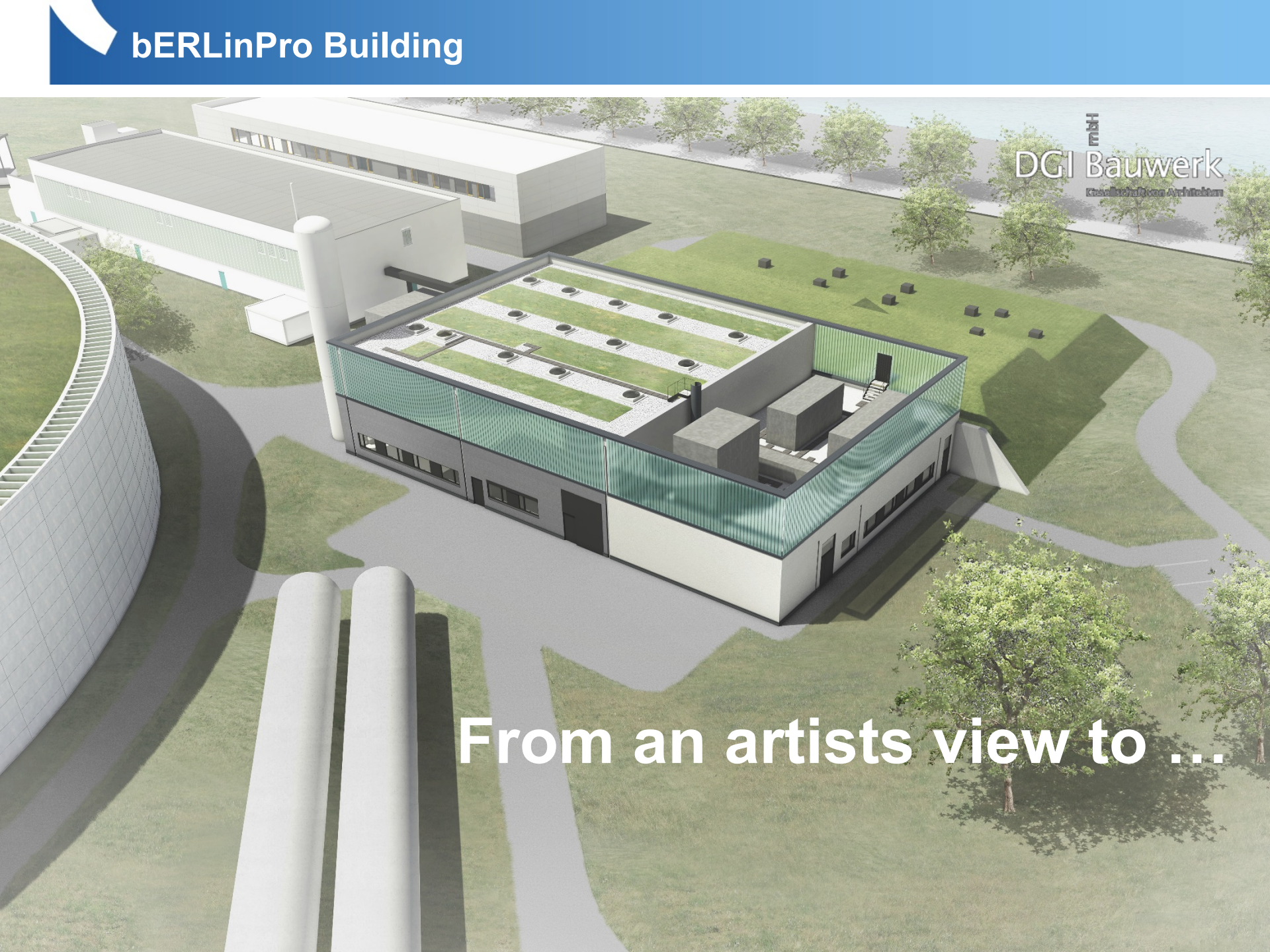

view north-west



LN₂
storage

High-bay
building

BESSY II

Technical Infrastructure building

Underground
bunker

Helium gas
storage

view south-east

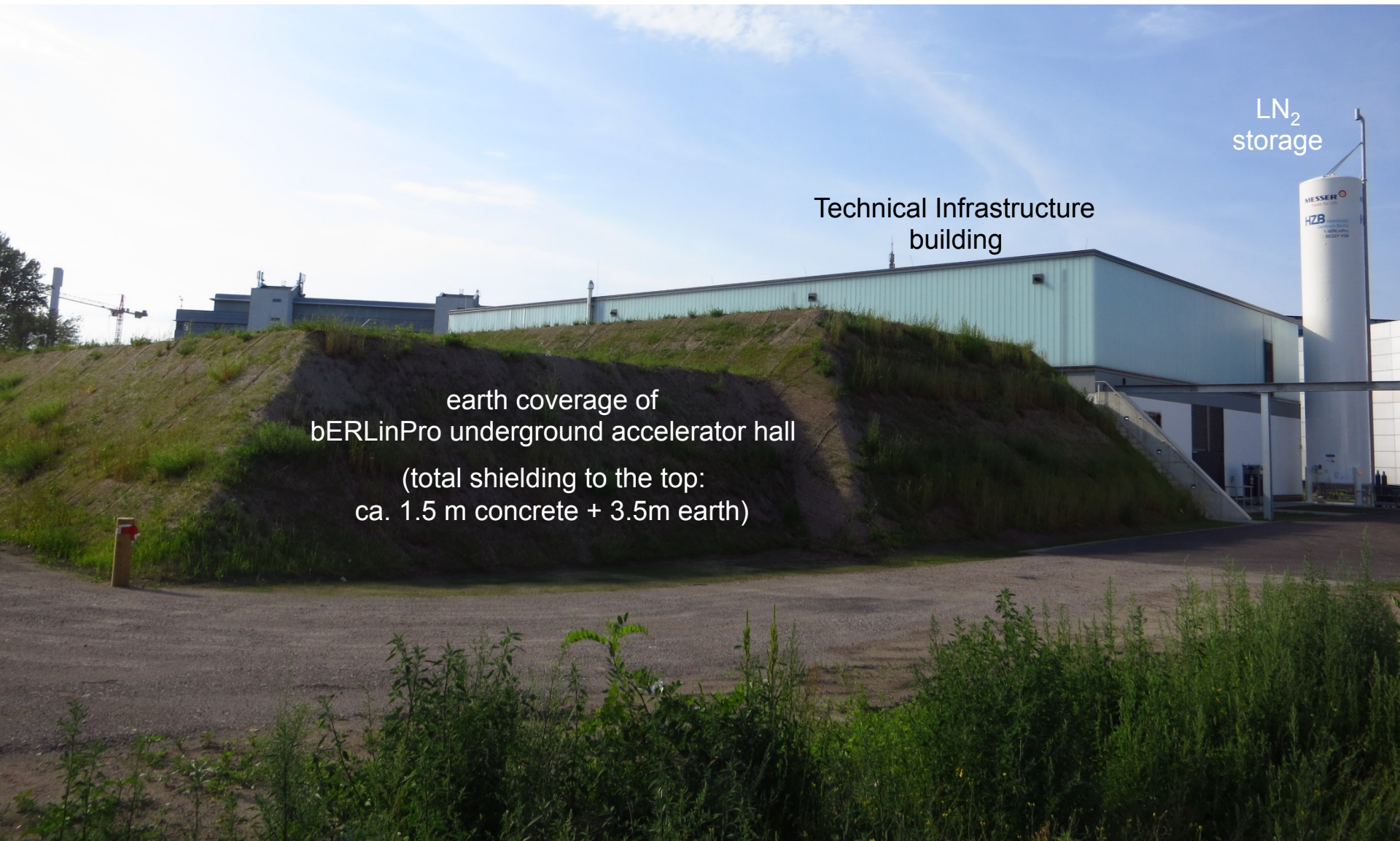

LN₂
storage

Technical Infrastructure
building

earth coverage of
bERLinPro underground accelerator hall
(total shielding to the top:
ca. 1.5 m concrete + 3.5m earth)

bERLinPro – performance parameter (simulations)

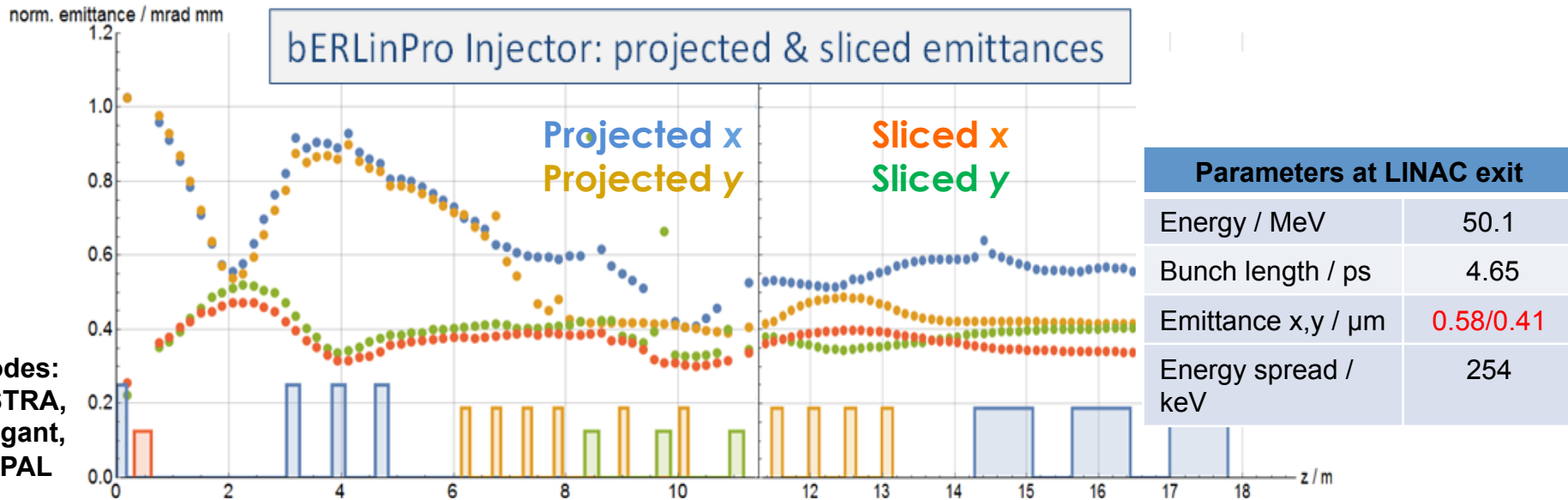

Optics (Short Bunch Mode, 10 pC): Bunch size & Emittance

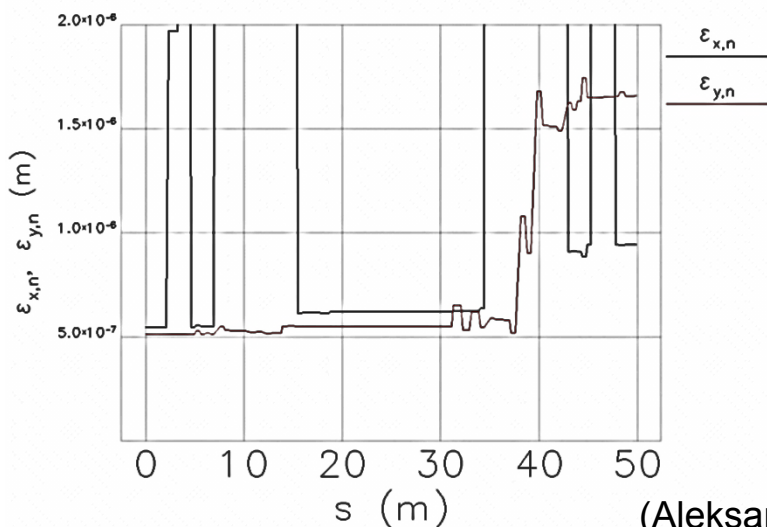

adrupc

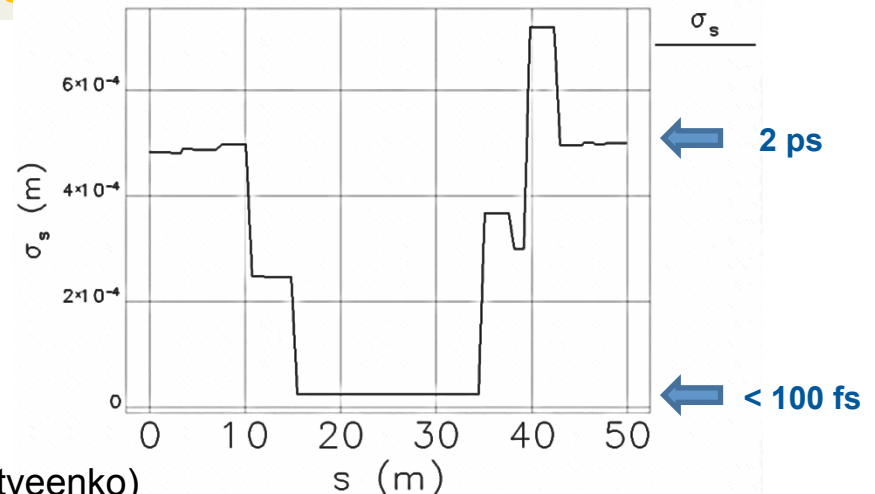

sigma matrix--input: recirc.ele lattice: recirc_ff.lte

sigma matrix--input: recirc.ele lattice: recirc_ff.lte

(Aleksandr Matveenko)

Beam Break Up: resonant interaction of short & long range cavity wake fields with the generating bunch or subsequent bunches → **instability & beam loss**

e.g. **Multibunch BBU:** many flavours: cumulative / regenerative, transverse / longitudinal, single-/multi-cavity, single-/multiple-turn

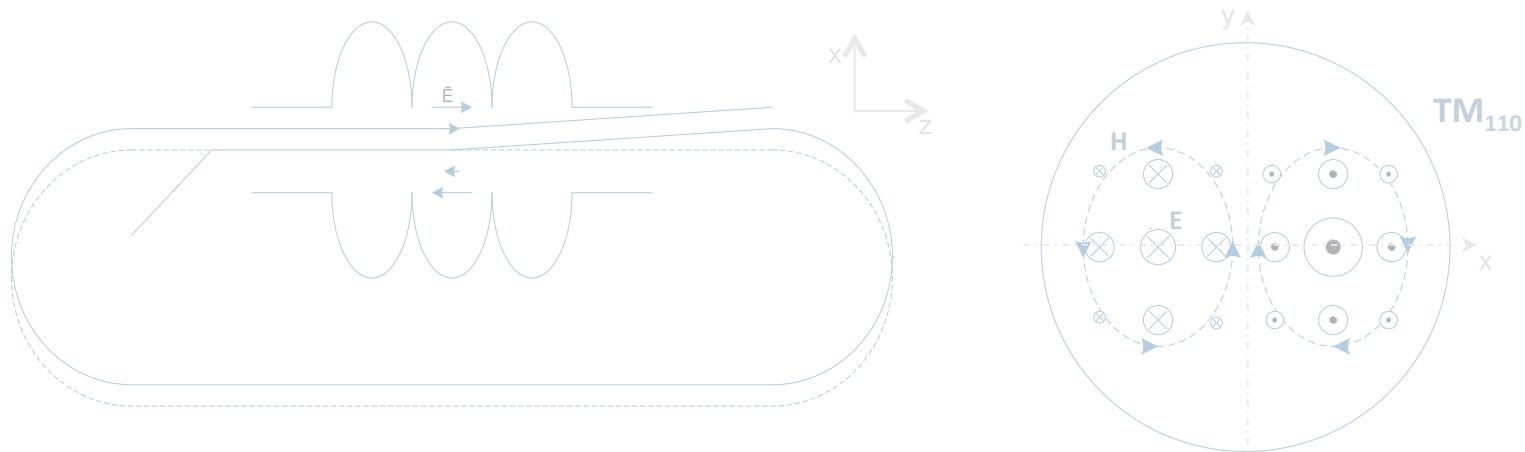

regenerative transverse BBU (single cavity, single turn, one mode):

1. bunch passes cavity “off axis” during accelerating passage → induce HOM voltage & transverse kick due to HOM
2. after recirculation kick transforms to an offset & HOM damp according to its Q
3. bunch passes cavity with varied offset on decelerating passage → induce HOM voltage & transverse kick due to HOM

BBU: HOM excitation exceeds HOM damping → kick strength growth up to loss

BBU threshold current

$$I_{th} = - \frac{2pc^2}{e\omega_\lambda \left(\frac{R}{Q}\right)_\lambda Q_\lambda m^* \sin(\omega_\lambda T_{rec})}$$

valid for:

- $m^* \sin(\omega_\lambda T_{rec}) < 0$
- $\omega_\lambda \neq n^* \omega_{rf}$

Countermeasures:

$$m^* = m_{12} \cos^2(\alpha) + (m_{14} + m_{32}) \sin(\alpha) \cos(\alpha) + m_{34} \sin^2(\alpha)$$

1. cavity design:

- HOMs: small R/Q, varying ω_λ at fixed $\omega_0 \rightarrow$ multi cavity BBU thresholds increase
- no HOM on a fundamental's harmonics: $\omega_\lambda \neq n^* \omega_{rf}$
- low Q for HOM \rightarrow HOM dampers (ferrites, waveguides, ...)

2. recirculator beam optics:

- for $\alpha=0$ & uncoupled beam transport $\rightarrow m^* = m_{12} = (\beta_1 \beta_2)^{1/2} \sin(\Delta\varphi_x)$
 \rightarrow stable for $\Delta\varphi = n\pi$
- adjust $\sin(\omega_\lambda T_{rec}) = 0$ for worst HOM
 large path length change \rightarrow impractical ☹️

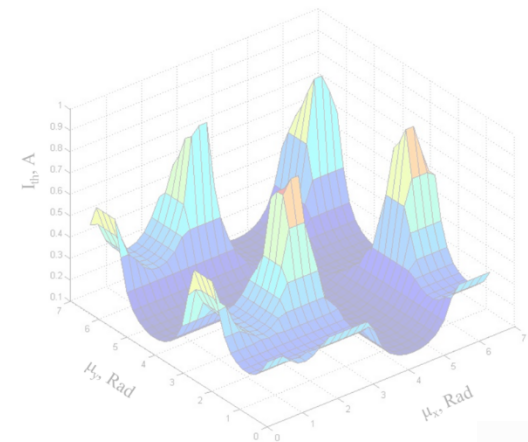

Y. Petenev

E. Pozdeyev et al.: Multipass beam breakup in energy recovery linacs, NIM-A 557 (2006) 176–188

G. Hoffstaetter et al.: Beam-breakup instability theory for energy recovery linacs, PRST-AB 7, 054401 (2004)

G. Hoffstaetter et al.: Recirculating beam-breakup thresholds for polarized higher-order modes with optical coupling, PRST-AB 10, 044401 (2007)

Unwanted Beam

Halo

generated by / together with wanted beam

- scattered particles (residual gas, IBS)
- laser stray light on cathode
- laser: limited extinction ratio
- ... (?)

moving together with wanted beam at design rf phases → same energy, no dispersive separation

Dark Current

generated independently of wanted beam (laser off)

- field emission in rf cavities
- ghost pulses from laser
- ... (?)

beside Dark Current from the gun → lower energy than wanted beam → lost in dispersive regions









Unwanted Beam

Amount:

- not reliably predictable for most sources

Loss positions:

- with initial beam parameter (place of origin, momenta) loss position along the machine can be calculated for the various generation processes → loss probability (to be weighted with unknown loss current ☹)

source	generating process	loss positions	amount
Halo	scattered Particles		
	stray light – laser halo		
Dark Current	field emission gun cath & plug		
	field emission booster & linac		

UBW 2012: <https://indico.helmholtz-berlin.de/conferenceDisplay.py?confId=2>

Energy Recovery Linacs can provide high current, high quality beams for single pass experiments in flexible setups

multi user light sources, collider, cooler, compact sources, ...

cw superconducting RF is the enabling technology

high gradient, large apertures

many challenges to be addressed

low emittance/high current sources, HOM damped cavities (BBU), flexible bunch compression, control of unwanted beam, optimising SRF efficiency (high gradient, high Q_0)

ongoing, worldwide effort to push ERL technology

bERLinPro, *cERL*, *BNL ERL*, CBETA Cornell Injector + FFAG ERL, JLAB ERL-FEL, Beijing University & IHEP, NovoERL BINP, MESA, S-DALINAC ERL, PERLE@ORSAY

Thanks to many of my colleagues providing me data and information!

Special thanks to my colleague Michael Abo-Bakr for transparencies on beam dynamic issues.

Some historical facts taken from G. Krafft's talk "What is an ERL, and why there might be one in your future", ERL Symposium, DPG Frühjahrstagung Darmstadt, 03/2016

Finis