

MULTI-PARTICLE EFFECTS IN PARTICLE ACCELERATORS (I)

G. Rumolo

Thanks to: D. Brandt, W. Herr, A Hofmann, E. Métral, R. Steerenberg

Overview on the course

2 hours to explain all the basics of multi-particle effects and reasons why they are object of study

- 1 hour

- Introduction, motivations, glossary, classifications...

- Space charge

- Some examples of instabilities, bunch oscillation modes

- 1 hour

- Numerical modeling of multi-particle effects

- Examples of experimental observations

General definition of *multi-particle processes* in an accelerator or storage ring

Class of phenomena in which the evolution of the particle beam cannot be studied as if the beam was a single particle (as is done in beam optics), but depends on the combination of **external fields and interaction between particles**. Particles can interact between them through

- **Self generated fields:**

- Direct space charge fields

- Electromagnetic interaction of the beam with the surrounding environment through the beam's own images and the wake fields (impedances)

- Interaction with the beam's own synchrotron radiation

- Long- and short-range **Coulomb collisions**, associated to intra-beam scattering and Touschek effect, respectively

- Interaction of electron beams with **trapped ions**, proton/positron/ion beams with **electron clouds, beam-beam** in a collider ring, **electron cooling** for ions

**MULTI-PARTICLE PROCESSES ARE DETRIMENTAL FOR THE BEAM
(DEGRADATION AND LOSS, SEE NEXT SLIDES)**

DIRECT SPACE CHARGE FORCES

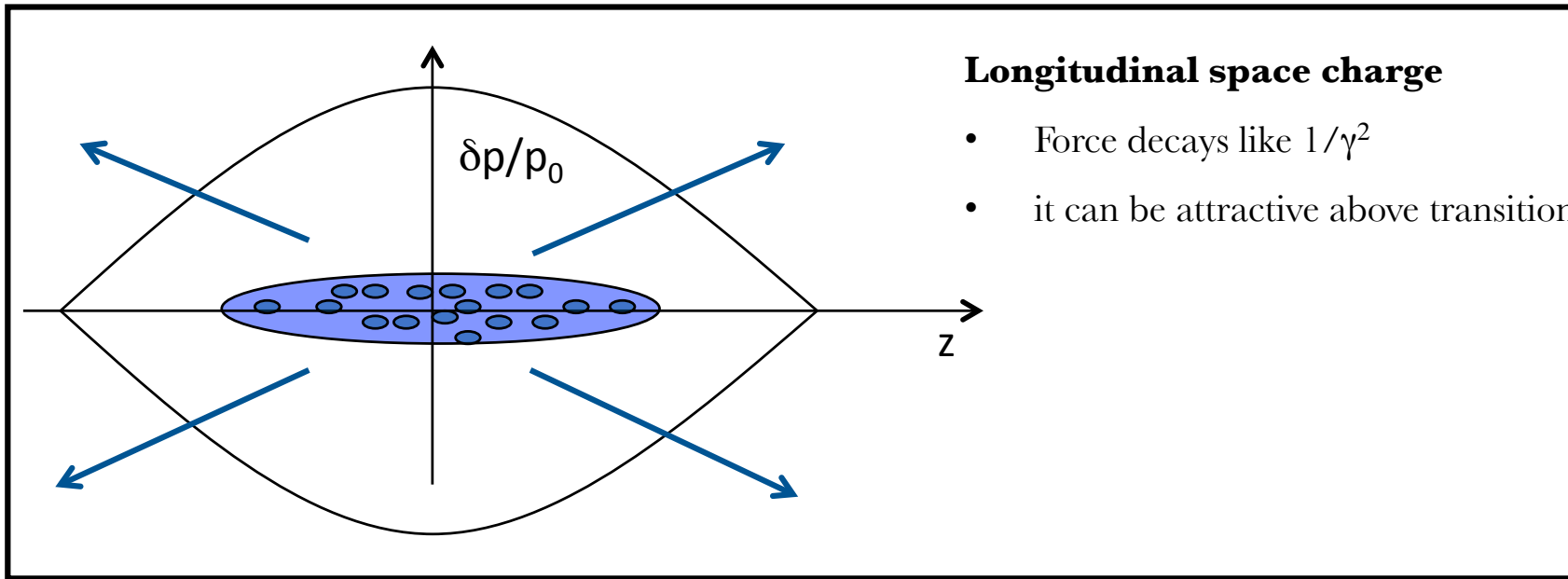

Transverse space charge

- Force decays like $1/\gamma^2\beta$
- It is always repulsive

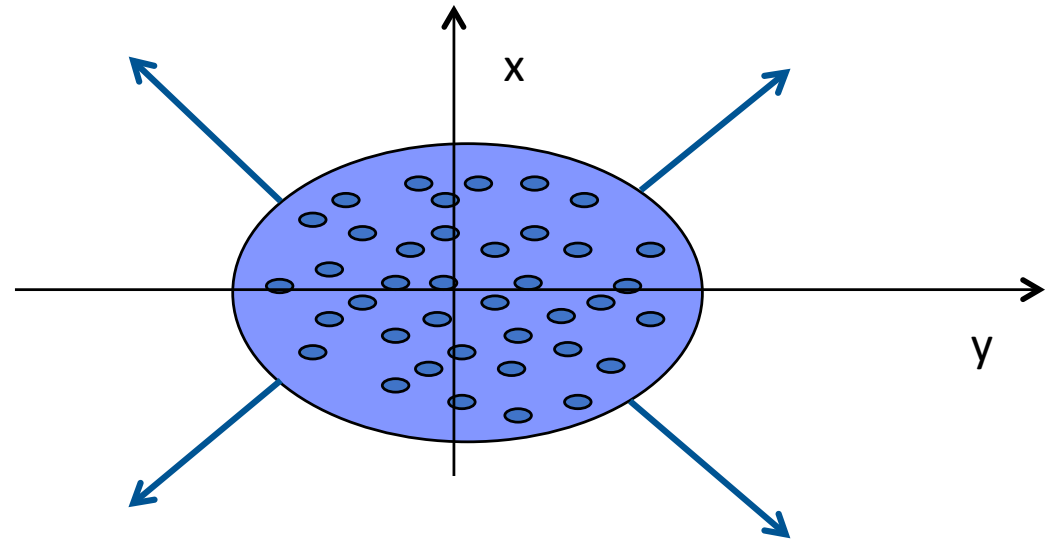

WAKE FIELDS (IMPEDANCES)

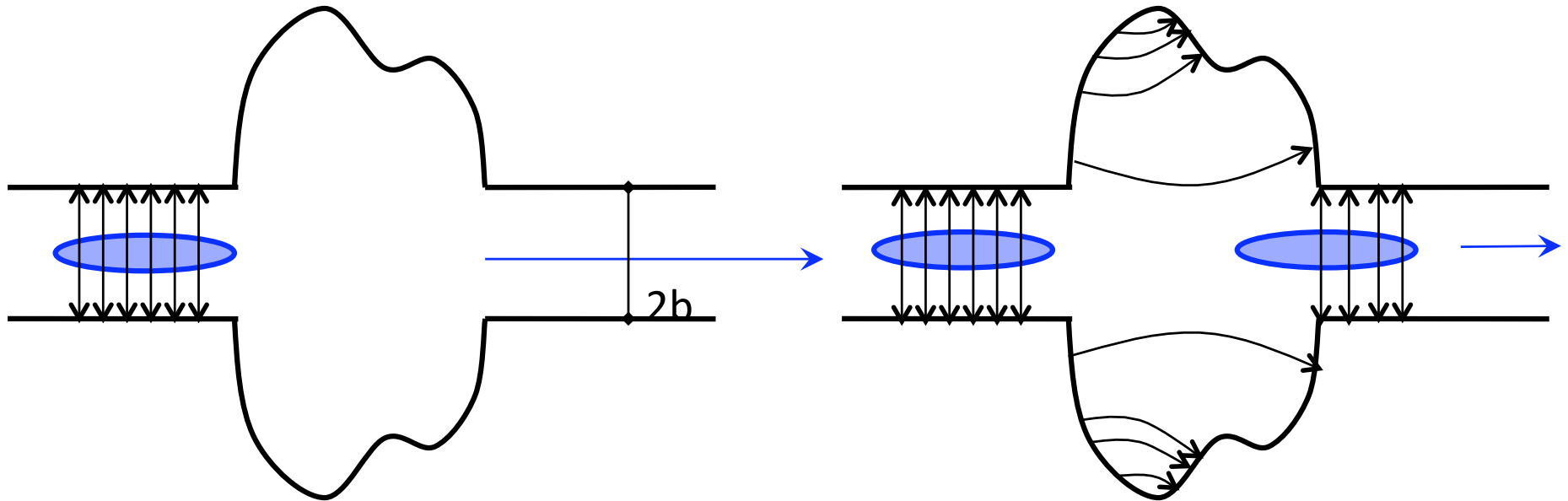

When the beam goes through a discontinuity, it induces an e-m field which keeps ringing after the beam has passed:

- Energy loss
- Effect intra-bunch and on following bunches

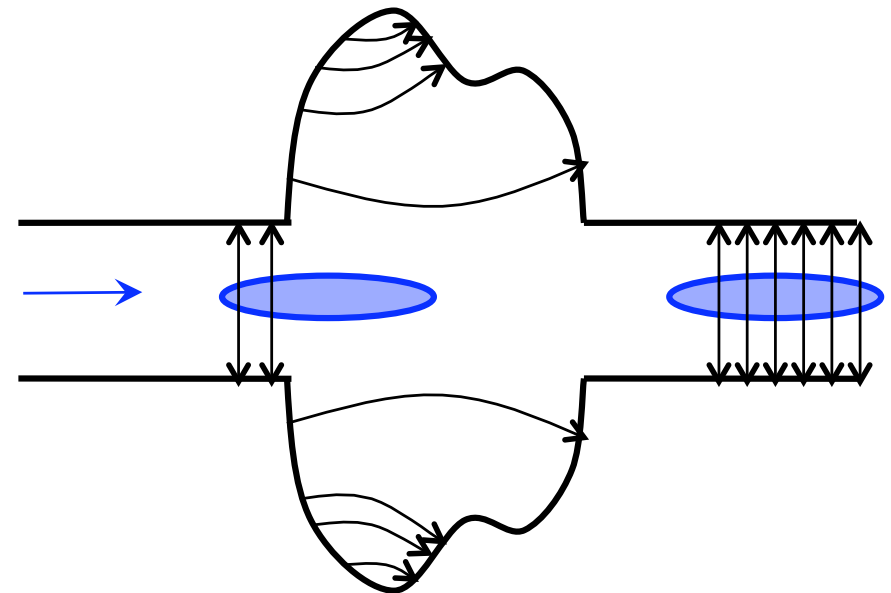

WAKE FIELDS (IMPEDANCES)

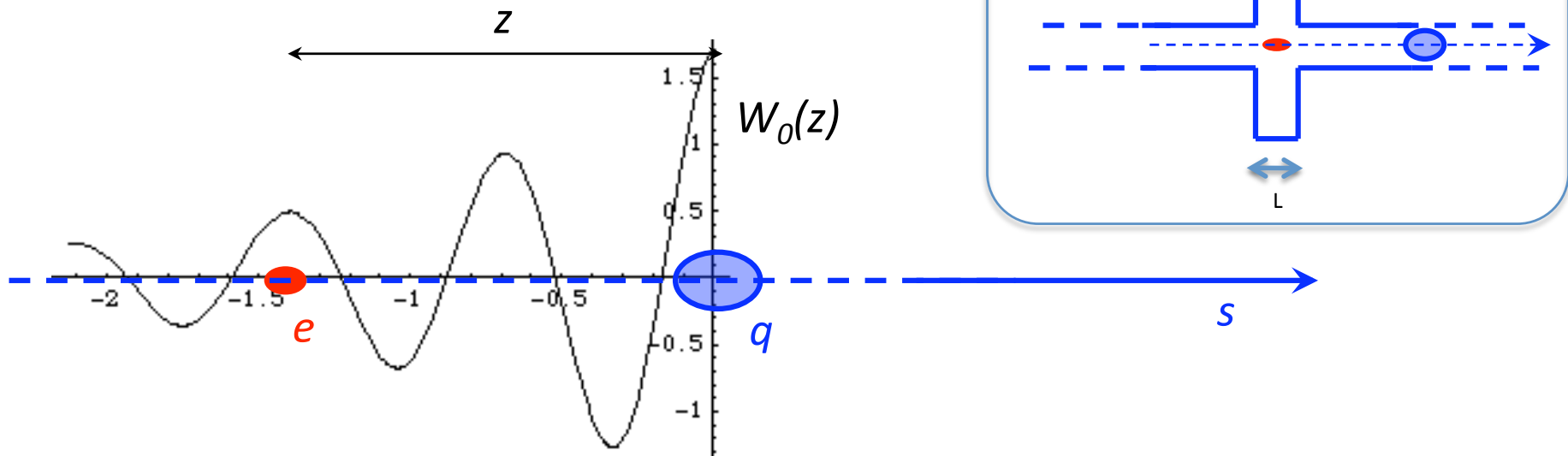

Model:

A **particle q** going through a device of length L , s ($0, L$), leaves behind an oscillating field and a **probe charge e** at distance z feels a force as a result. The integral of this force over the device defines the **wake field** and its Fourier transform is called the **impedance of the device of length L** .

$$\int_0^L F_{\parallel}(s, z) ds = -eqW_{\parallel}(z) \qquad \int_0^L F_{\perp}(s, z) ds = -eqxW_{\perp}(z)$$

$$Z_{\parallel(\perp)}(\omega) \equiv \frac{1}{c} \int_{-\infty}^{\infty} dz e^{-i\omega z/c} W_{\parallel(\perp)}$$

WAKE FIELDS (IMPEDANCES)

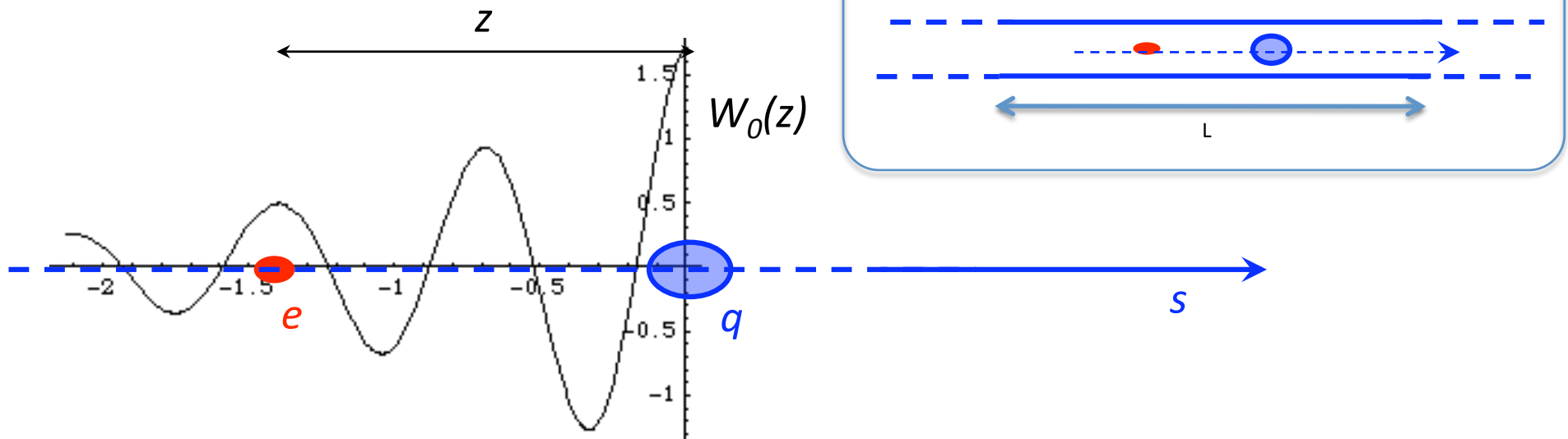

Model (cont's):

The device of length L can also be a segment of accelerator (defined by the simple beam pipe) and the wake is generated by the finite conductivity of the pipe material. In this case the wake field and the impedance are said to be of **resistive wall** type and the integration can be done over $L=2\pi R$

$$\int_0^L F_{\parallel}(s, z) ds = -eqW_{\parallel}(z) \qquad \int_0^L F_{\perp}(s, z) ds = -eqxW_{\perp}(z)$$

$$Z_{\parallel(\perp)}(\omega) \equiv \frac{1}{c} \int_{-\infty}^{\infty} dz e^{-i\omega z/c} W_{\parallel(\perp)}$$

WAKE FIELDS (IMPEDANCES)

The full ring is usually modeled with a so called **total impedance** made of three main components:

- **Resistive wall** impedance



- Several **narrow-band resonators** at lower frequencies than the pipe cutoff frequency c/b (b beam pipe radius)

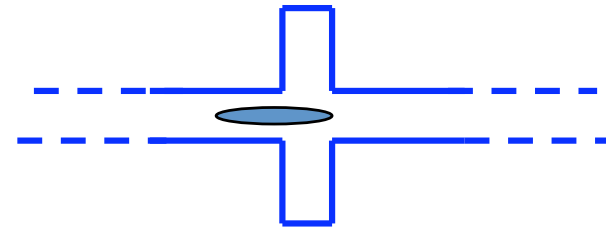

- One **broad band resonator** at $\omega_r \sim c/b$ modeling the rest of the ring (pipe discontinuities, tapers, other non-resonant structures like pick-ups, kickers bellows, etc.)

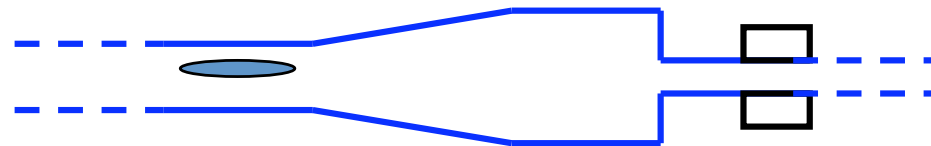

⇒ The total impedance is **allocated to the single ring elements** by means of off-line calculation prior to construction/installation

⇒ **Total impedance** designed such that the nominal intensity is stable

ELECTRON CLOUD

Principle of electron multipacting:

Example of LHC

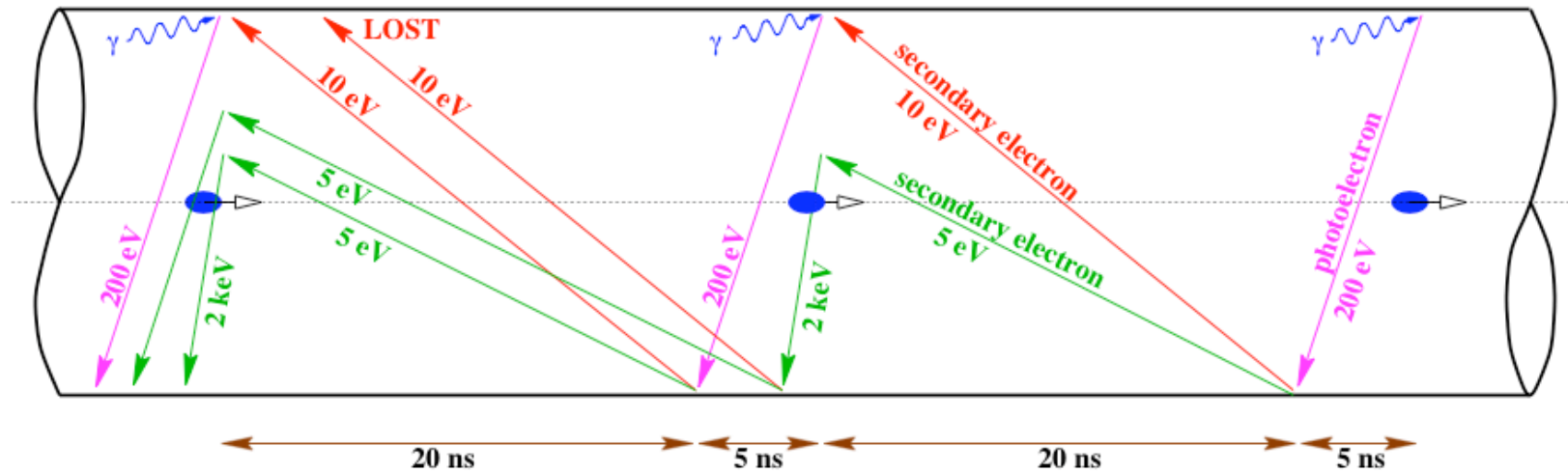

Electron multiplication is made possible by:

- ✓ Electron generation due to photoemission, but also residual gas ionization
- ✓ Electron acceleration in the field of the passing bunches
- ✓ Secondary emission with efficiency larger than one, when the electrons hit the inner pipe walls with high enough energy

ELECTRON CLOUD

Photoelectrons produced by the synchrotron radiation are accelerated by the bunches and quickly accumulate in the vacuum chamber (example, wiggler of a CLIC damping ring)

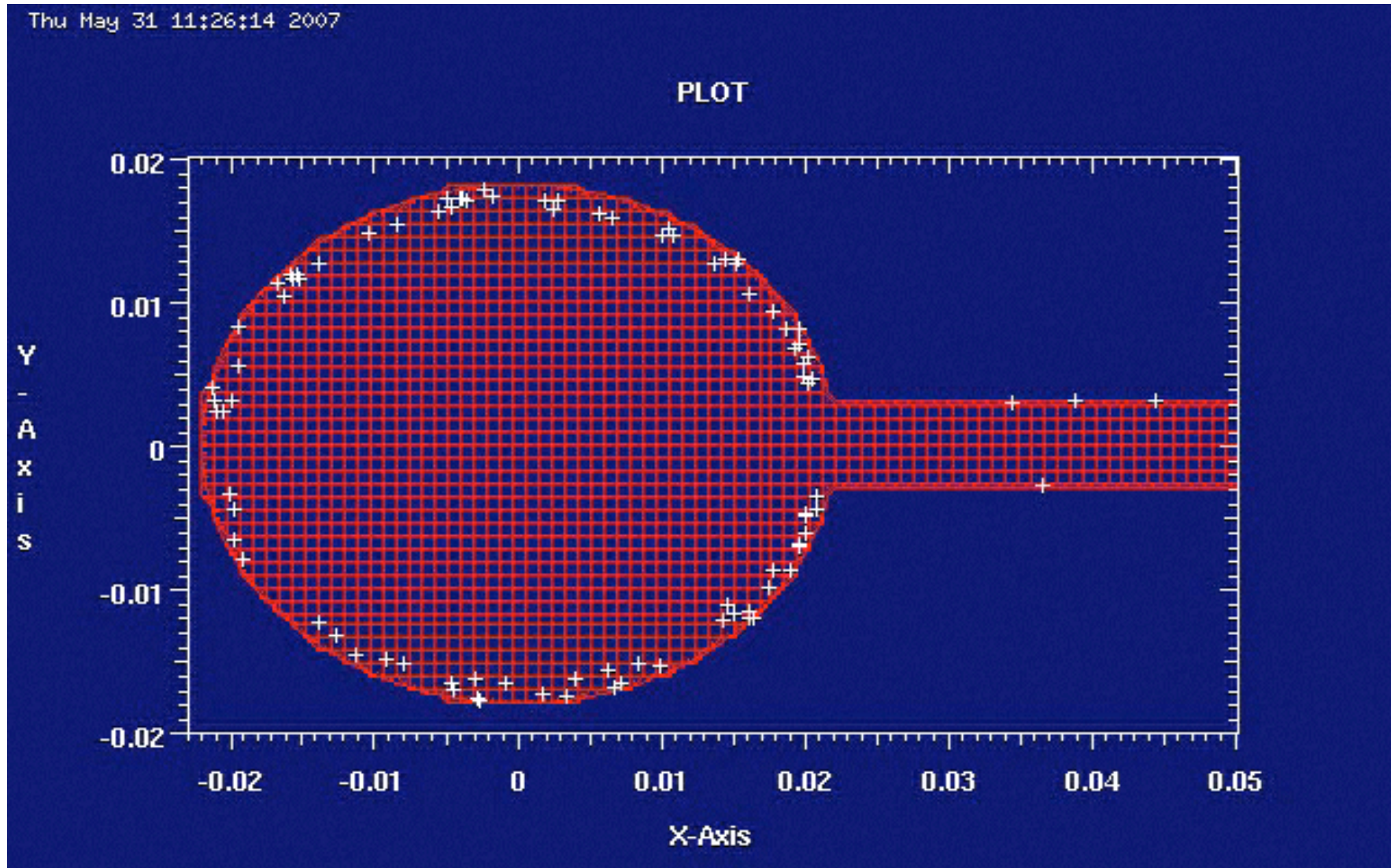

Several names to describe these effects...

Multi-particle is the most generic attribute. *High-current*, *high-intensity*, *high brightness* are also used because these effects are important when the beam has a high density in phase space (many particles in little volume)

Other labels are also used to refer to different subclasses

- **Collective effects (coherent):**

- The beam resonantly responds to a self-induced electromagnetic excitation

- Are **fast** and visible in the beam **centroid motion** (tune shift, instability)

- **Collective effects (incoherent):**

- Excitation moves with the beam, spreads the frequencies of particle motion.

- Lead to particle **diffusion** in phase space and **slow emittance growth**

- **Collisional effects (incoherent):**

- Isolated two-particle encounters have a global effect on the beam dynamics (diffusion and emittance growth, lifetime)

- **Two-stream phenomena:**

- Two component plasmas needed (beam-beam, pbeam-ecloud, ebeam-ions) and the beam reacts to an excitation caused by another „beam“

Some examples....

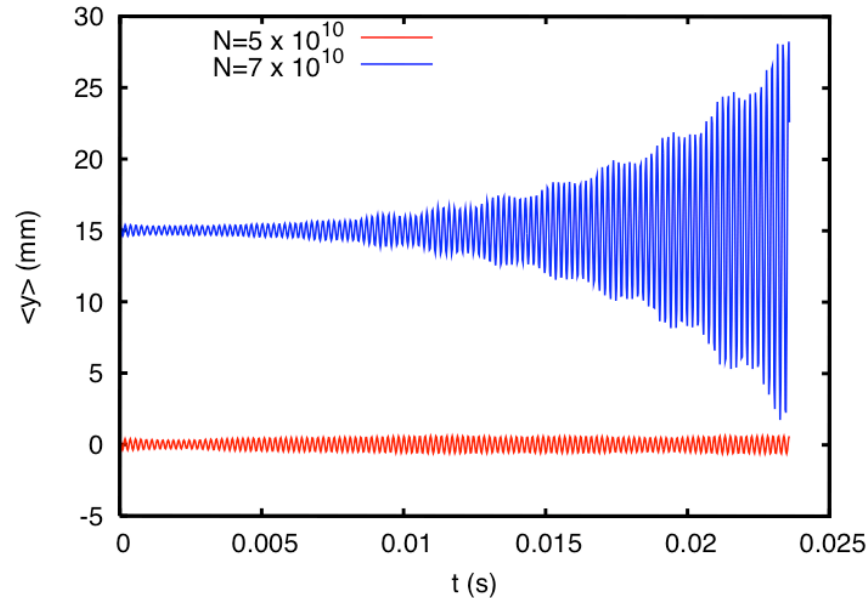

Coherent effect:

When the bunch current exceeds a certain limit (current threshold), the centroid of the beam, e.g. as seen by a BPM, exhibits an exponential growth and the beam is lost within few milliseconds (simulation of an SPS bunch)

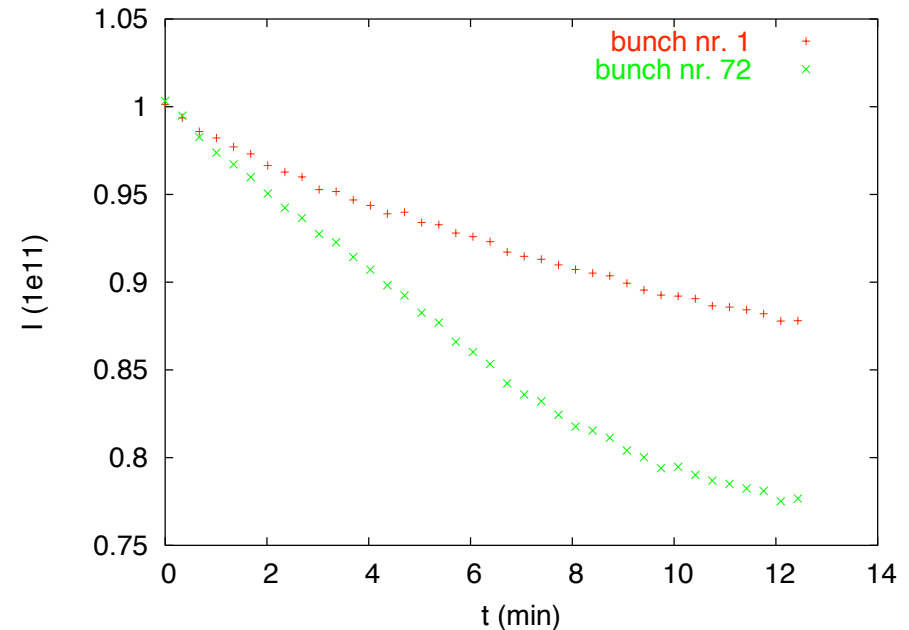

Incoherent effect:

Slow beam loss. First and last bunch of an SPS train of 72 bunches gradually lose their particles (10% and 25%, respectively) over several minutes (data from SPS, 2004)

More examples... (plots show measured beam intensity vs time)

BNL-RHIC, Au-Au operation, Run-4 (2004)

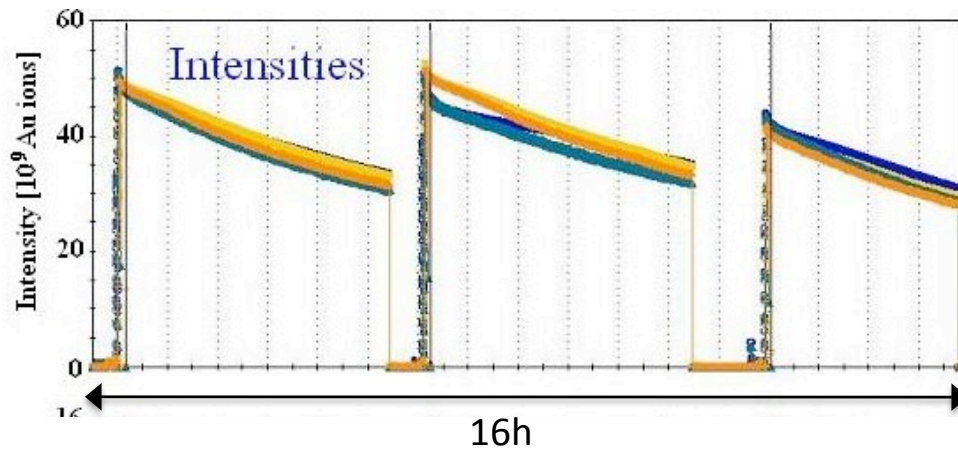

CERN-SPS (II) TMC Instability (2003)

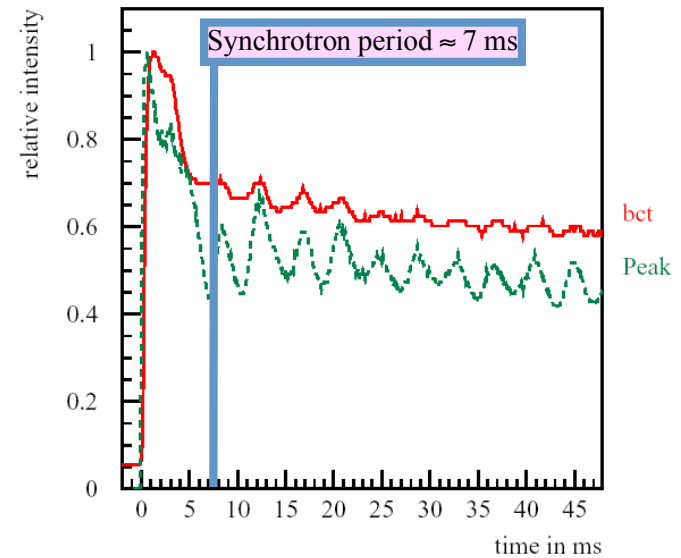

NOTE THE DIFFERENT TIME SCALE ON THESE PLOTS!

Why are multi-particle effects important ?

The performance of an accelerator is usually limited by a multi-particle effect!!

→ When the beam current in a machine is pushed above a certain limit (intensity threshold), **intolerable losses or beam quality degradation** appear due to these phenomena

→ How these effects can affect the beam:

- **Coherent effects can be:**

- Transverse

- ✓ coherent tune shift

- ✓ fast beam loss due to instability

- Longitudinal (energy loss, bunch lengthening, synchrotron tune shift)

- **Incoherent effects can be:**

- Longitudinal or transverse

- ✓ emittance growth, incoherent tune shift, tune spread, bad lifetime

- **Two-stream phenomena are:**

- result into coherent or incoherent effects

Types of collective effects (I)

- Single or multi-bunch behavior depends on the range of action of the wake fields
 - Single bunch effects are usually caused by short range wake fields (broad-band impedances)
 - Multi bunch or multi-turn effects are usually associated to long range wake fields (narrow-band impedances)

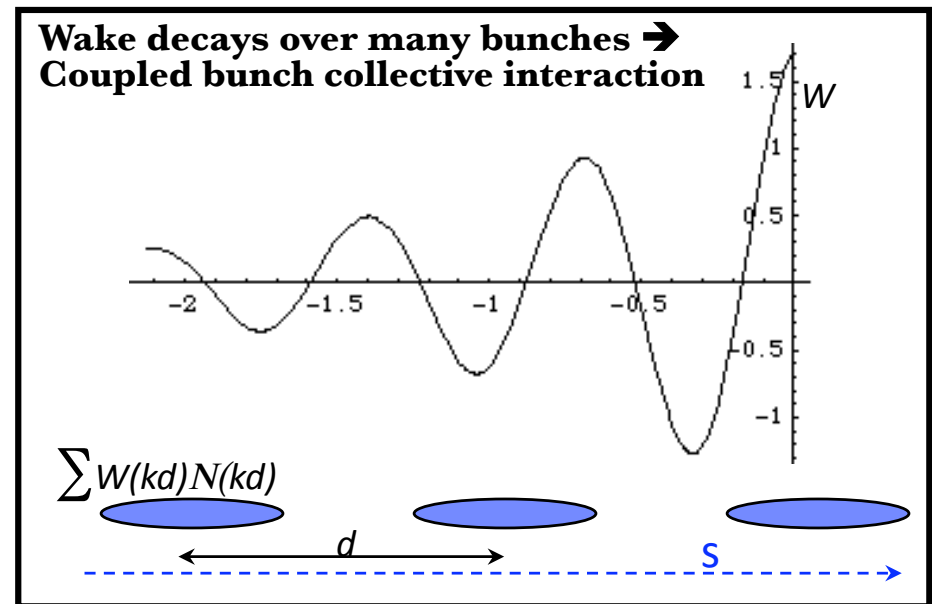
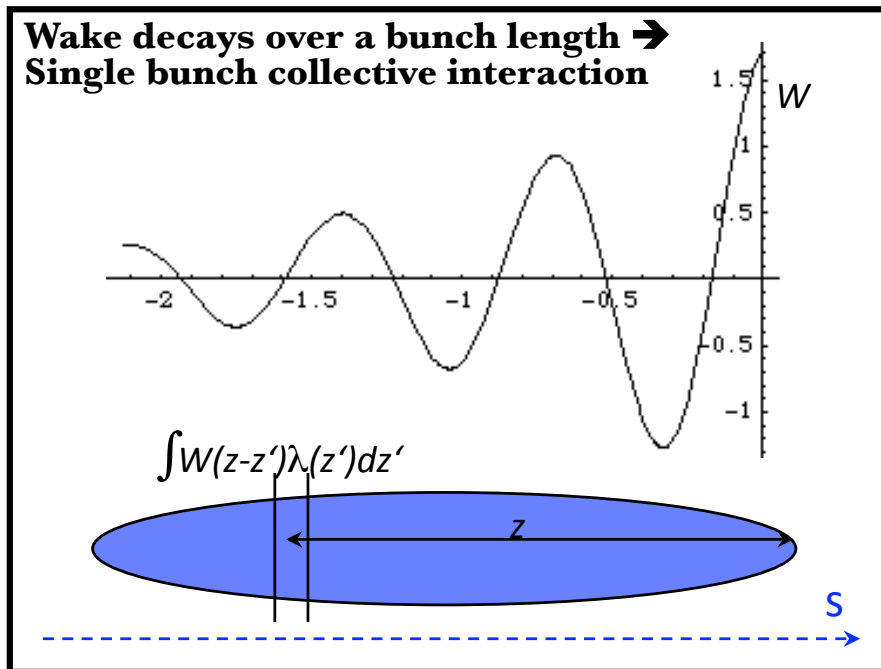

Types of collective effects (II)

- **Transverse:**

- Single bunch

- ✓ Head-tail instability

- ✓ Transverse Mode Coupling Instability (TMCI), also referred to as beam break-up or strong (fast) head-tail instability

- ✓ Electron Cloud Instability (ECI)

- Coupled bunch instability

- ✓ Coupling between subsequent bunches through long range wake fields or electron cloud, Ion Instability, Fast-Ion Instability

- **Longitudinal:**

- Single bunch

- ✓ Potential well distortion, energy loss

- ✓ Microwave instability, also referred to as turbulent bunch lengthening

- Coupled bunch instability

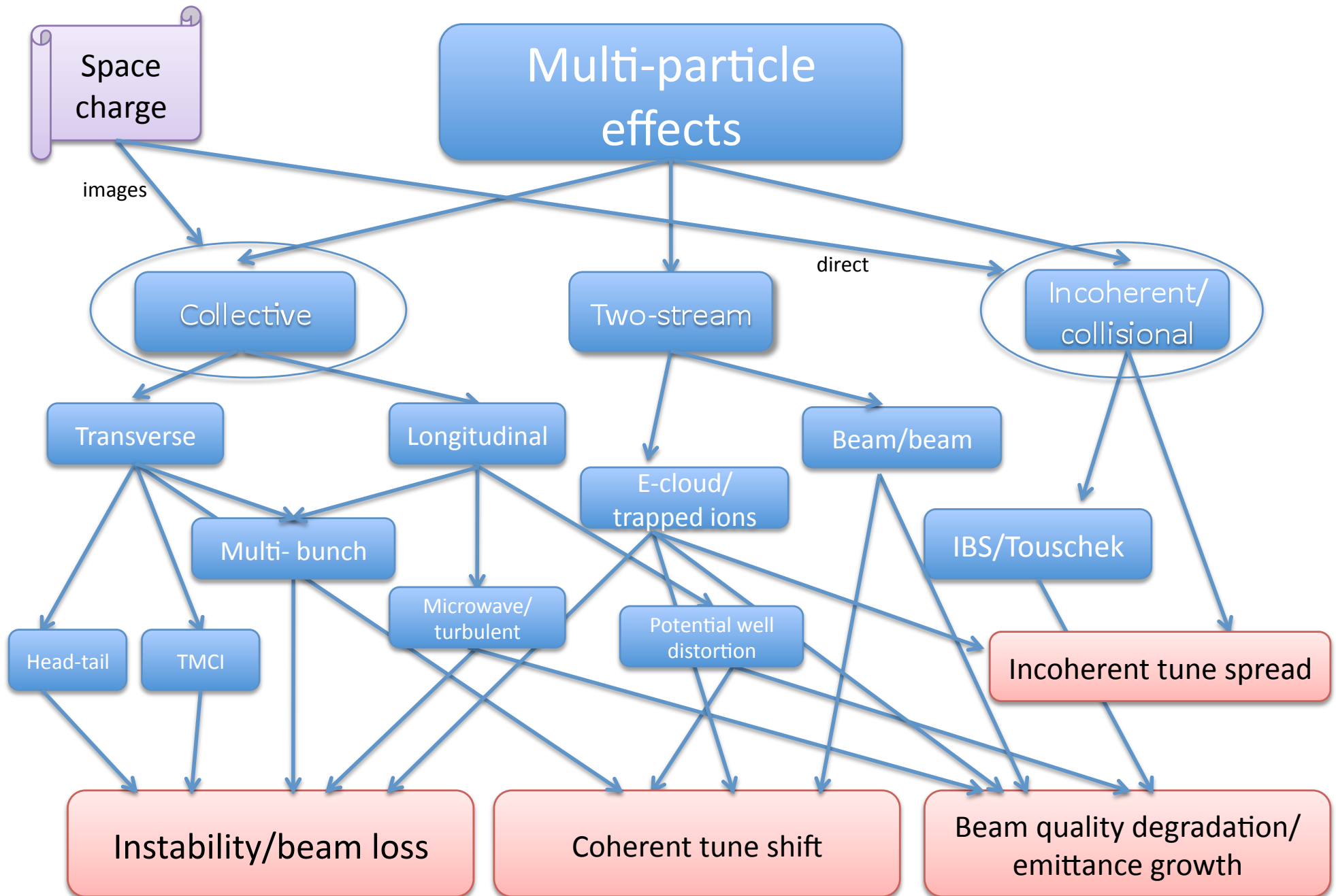

Direct space charge effect (transverse)

- To quantify the **direct space charge effect**
 - Consider a continuous beam with circular cross section
 - Calculate the electromagnetic force from the beam acting on a generic particle inside the beam itself
 - Electric and magnetic components have opposite signs and scale between them with β^2 . There is perfect compensation only when $\beta=1$.

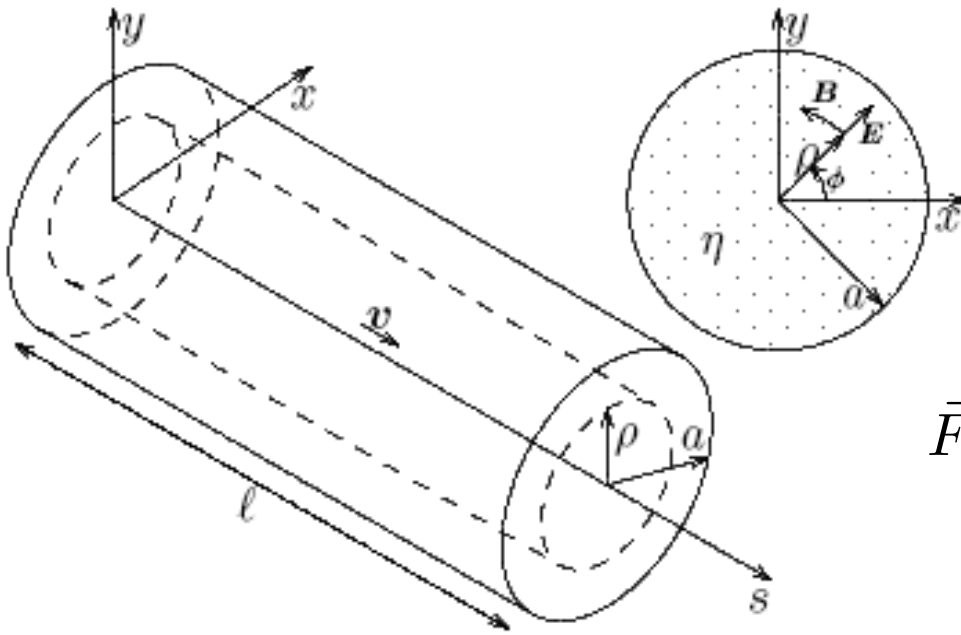

$$\begin{aligned}\vec{F} &= \vec{F}_E + \vec{F}_B = e \left(\vec{E} + \vec{v} \times \vec{B} \right) = \\ &= \frac{e\lambda\vec{\rho}}{2\epsilon_0\pi a^2} (1 - \beta^2) = \frac{e\lambda\vec{\rho}}{2\pi\epsilon_0\gamma^2 a^2}\end{aligned}$$

Defocusing space charge....

- Looking now only at the vertical plane
 - Additional force causes locally a defocusing deflection dy'
 - This translates into a local contribution to the tune depression $dQ_y(s)$
 - Tune shift ΔQ_y is found integrating all over the machine circumference

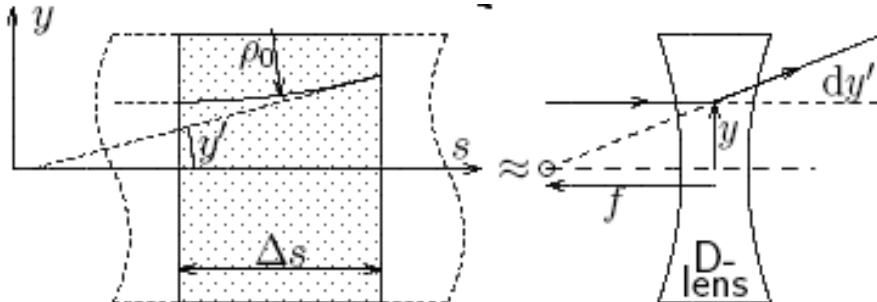
$$\left\{ \begin{aligned} F_y &= m_0 \gamma \frac{d^2 y}{dt^2} = m_0 \gamma \beta^2 c^2 \frac{dy'}{ds} \\ \frac{dy'}{y} &= \frac{2r_0 \lambda ds}{e \beta^2 \gamma^3 a^2} \end{aligned} \right.$$

$$dQ_y(s) = -\frac{\beta_y(s)}{4\pi} \frac{dy'}{y} = -\frac{r_0 \lambda \beta_y(s) ds}{2\pi e \beta^2 \gamma^3 a^2(s)}$$

$$\Delta Q_y = \oint dQ_y(s) = -\frac{r_0 \lambda}{2\pi e \beta^2 \gamma^3} \oint \frac{\beta_y(s) ds}{a^2(s)} = -\frac{r_0 \lambda R}{e \beta \gamma^2 \epsilon_{yn}}$$

Defocusing space charge....

- The direct space charge tune shift of a continuous beam with circular cross section
 - Is negative, because **space charge transversely always defocuses**
 - Is **proportional to the number of particles** inside the beam N
 - decreases with the beam energy ($\beta^{-1}\gamma^{-2}$)
 - is **inversely proportional to the normalized emittance** and does not depend on the local beta functions or beam sizes.

$$\Delta Q_{x,y} = - \frac{r_0 N}{2\pi e \beta \gamma^2 \epsilon_{xn,yn}}$$

$$r_0 = \frac{e^2}{4\pi\epsilon_0 m_0 c^2} = \begin{matrix} 1.54 \cdot 10^{-18} \text{ m protons} \\ 2.82 \cdot 10^{-15} \text{ m electrons} \end{matrix}$$

Some important extensions (I)

- If the beam has an elliptical cross section:
 - forces are still linear and can be calculated
 - defocusing contribution in both transverse directions

$$\Delta Q_x = -\frac{r_0 \lambda}{\pi e \beta \gamma^2 \epsilon_{xn}} \oint \frac{a}{a+b} ds$$
$$\Delta Q_y = -\frac{r_0 \lambda}{\pi e \beta \gamma^2 \epsilon_{yn}} \oint \frac{b}{a+b} ds$$

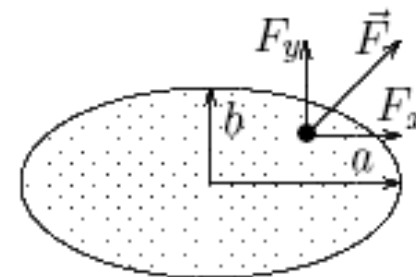

Some important extensions (II)

- If the beam does not have a circular nor elliptical cross section
 - Beam field over the beam cross section is nonlinear
 - Particles will see different tune shifts according to their betatron amplitudes. This causes a tune spread over the beam particles
 - The previous formulae will still hold for particles with small amplitudes (in the linear region of the beam force)

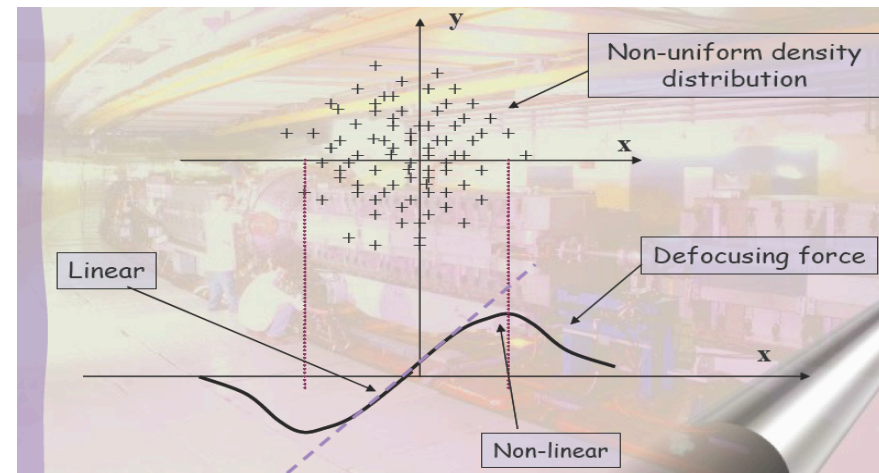
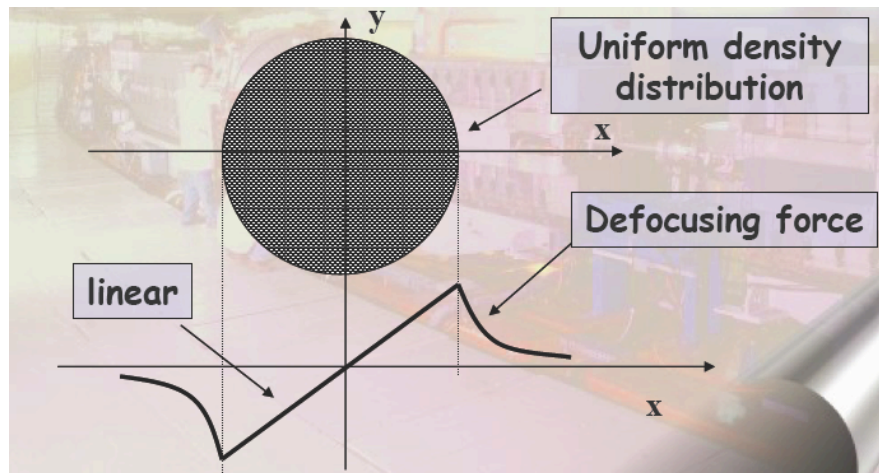

Some important extensions (III)

- If the beam is bunched and has an s-dependent line density
 - Relativistic field has an opening angle of $1/\gamma$
 - We can look at the bunched beam as locally continuous if the density $\lambda(s)$ changes smoothly (i.e. does not change much over $\Delta s = a/\gamma$)
 - The tune shift will depend on the position of the particle along the bunch
 - This translates into tune modulation with the synchrotron period, because particles execute synchrotron oscillations longitudinally

$$\Delta Q_{x,y} = - \frac{r_0 \lambda(s) R}{e \beta \gamma^2 \epsilon_{xn, yn}}$$

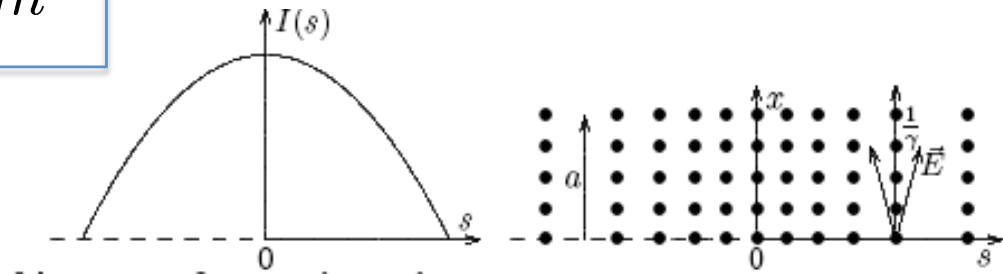

The effect of the images (incoherent)

- The presence of a beam pipe also contributes to the single particle tune shift
 - Assume two parallel plates at a distance h from the beam
 - There are infinite images placed at $\pm 2nh$, which contribute to E_i

$$E_{iny} = \frac{(-1)^n \lambda}{2\pi\epsilon_0} \left(\frac{1}{2nh + y} - \frac{1}{2nh - y} \right) \approx -\frac{\lambda y}{4\pi\epsilon_0 h^2} \frac{(-1)^n}{n^2}$$

$$E_{iy} = \sum_1^\infty E_{iny} = \frac{\lambda y}{4\pi\epsilon_0 h^2} \frac{\pi^2}{12}, \quad \text{div} \vec{E}_i = 0 \rightarrow E_{ix} = -\frac{\lambda x}{4\pi\epsilon_0 h^2} \frac{\pi^2}{12}$$

$$F_{ix} = -\frac{e\lambda}{\pi\epsilon_0} \frac{\pi^2}{48h^2} x \quad F_{iy} = \frac{e\lambda}{\pi\epsilon_0} \frac{\pi^2}{48h^2} y$$

$$\Delta Q_{x,y} = \pm \frac{2r_0 \lambda R \langle \beta_{x,y} \rangle}{e\beta^2 \gamma} \frac{\pi^2}{48h^2}$$

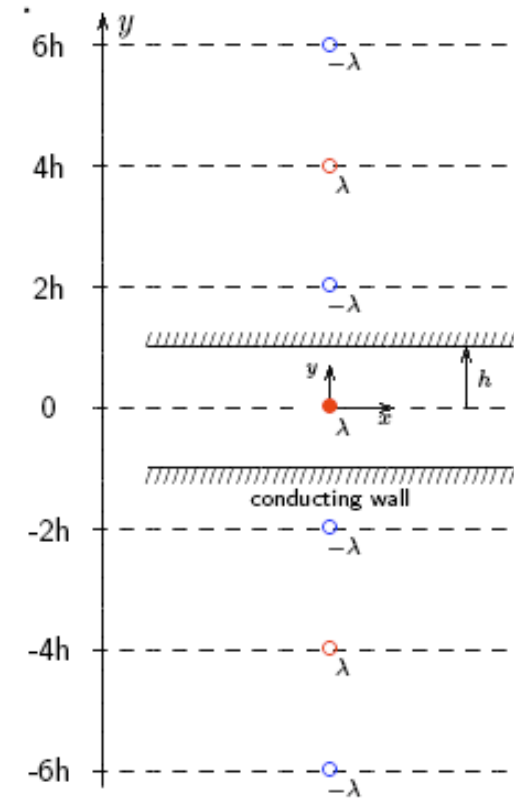

The effect of the images (coherent)

- The presence of a beam pipe also causes a net electric force on the beam, when it is rigidly offset as a whole

→ Direct space charge cannot because it moves along with the beam

→ This force F_c affects the beam collective motion, therefore it is responsible for a coherent tune shift

$$E_{cny} = -\frac{(-1)^n \lambda \bar{y}}{4\pi\epsilon_0 h^2} \left(\frac{1}{n^2} - \frac{(-1)^n}{n^2} \right)$$

$$E_{cy} = \sum_1^{\infty} E_{cny} = \frac{\lambda \bar{y}}{4\pi\epsilon_0 h^2} \left(\frac{\pi^2}{12} + \frac{\pi^2}{6} \right)$$

$$F_{cy} = \frac{e\lambda}{\pi\epsilon_0} \frac{\pi^2}{16h^2} \bar{y}$$

$$\Delta Q_{cy} = -\frac{2r_0 \lambda R \langle \beta_y \rangle}{e\beta^2 \gamma} \frac{\pi^2}{16h^2}$$

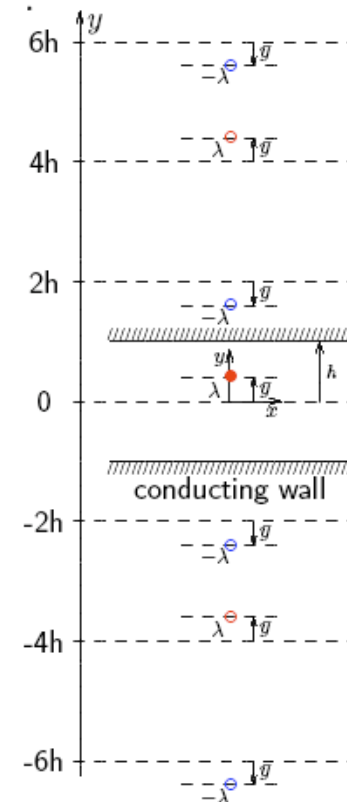

Summary of the space charge tune shifts

- All the space charge tune shifts of a continuous beam with circular cross section between two parallel perfectly conducting plates

	Incoherent (direct)	Incoherent (indirect)	Coherent (indirect)
Horizontal	$\Delta Q_{dx} = -\frac{r_0 N}{2\pi e\beta\gamma^2\epsilon_{xn}}$	$\Delta Q_{ix} = \frac{2r_0\lambda R\langle\beta_x\rangle}{e\beta^2\gamma} \frac{\pi^2}{48h^2}$	$\Delta Q_{cx} = 0$
Vertical	$\Delta Q_{dy} = -\frac{r_0 N}{2\pi e\beta\gamma^2\epsilon_{yn}}$	$\Delta Q_{iy} = -\frac{2r_0\lambda R\langle\beta_y\rangle}{e\beta^2\gamma} \frac{\pi^2}{48h^2}$	$\Delta Q_{cy} = -\frac{2r_0\lambda R\langle\beta_y\rangle}{e\beta^2\gamma} \frac{\pi^2}{16h^2}$

$$Q_{xcoh} - Q_{xinc} = -(\Delta Q_{dx} + \Delta Q_{ix}) = \frac{r_0\lambda R}{e\beta\gamma} \left(\frac{1}{\gamma\epsilon_{xn}} - \frac{\langle\beta_x\rangle\pi^2}{24\beta h^2} \right)$$

$$\begin{aligned} Q_{ycoh} - Q_{yinc} &= \Delta Q_{cy} - (\Delta Q_{dy} + \Delta Q_{iy}) = \frac{r_0\lambda R}{e\beta\gamma} \left(-\frac{2\langle\beta_y\rangle\pi^2}{16\beta h^2} + \frac{1}{\gamma\epsilon_{yn}} + \frac{2\langle\beta_y\rangle\pi^2}{48\beta h^2} \right) = \\ &= \frac{r_0\lambda R}{e\beta\gamma} \left(\frac{1}{\gamma\epsilon_{yn}} - \frac{\langle\beta_y\rangle\pi^2}{12\beta h^2} \right) \end{aligned}$$

What space charge tune shifts can cause

Problems caused by space-charge in rings

In rings space-charge can shift tunes into resonances where $Q = N/M$ is a simple rational fraction. Dipole imperfection deflects particle each turn in phase if $Q = \text{integer}$ and for a quadrupole error this happens if $Q = \text{half integer}$. Since space-charge shifts coherent and incoherent tunes differently and produces spread it may be difficult to avoid all resonances.

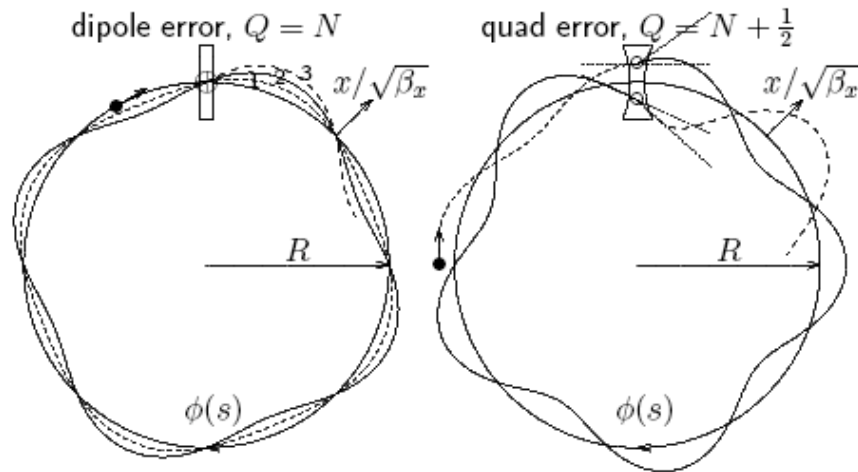

Related effects

Beam-beam effect: electric and magnetic forces ad.
Ions and electron clouds: don't move, no B -force.

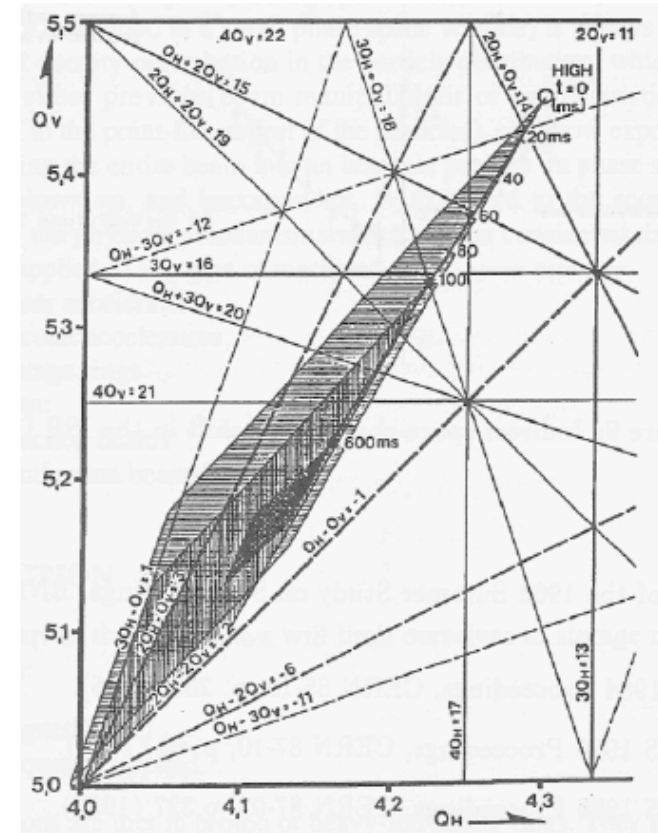

Direct space-charge tune shift and spread at different γ during acceleration (shaded areas), CERN booster, E. Brouzet, K.H. Schindl.

Instabilities

- Coherent transverse or longitudinal motion of a bunch can result into beam instability
 - A. **Single rigid bunch instability**: this is an instability affecting a bunch over multiple passages through the same impedance source
 - ✓ Long-range wake field, must extend over more than one turn
 - ✓ Typical source: narrow-band resonators, cavities, HOM in cavities
 - B. **Coupled rigid bunch instability**: this is an instability caused by the effect on a bunch of the sum of the wake fields left behind by the previous bunches
 - ✓ Long-range wake field, must extend over several interbunch gaps
 - ✓ Typical source: resistive wall, narrow-band resonators
 - C. **Single non-rigid bunch instability**: this is an instability in which the motion of the tail of a bunch is coupled to that of the head through a wake field
 - ✓ Short-range wake field, usually damped over one full bunch length
 - ✓ Typical source: broad-band impedance

A. Single rigid bunch instability (transverse)

- A bunch can become unstable passing several times through an impedance source (over successive turns, ring having circumference $C=2\pi R$)

→ Force felt by a probe charge at distance d from the bunch is proportional to the wake field $W_1(-d)$ and to the bunch offset y

→ This force F_c affects the bunch itself on successive turns and causes tune shift

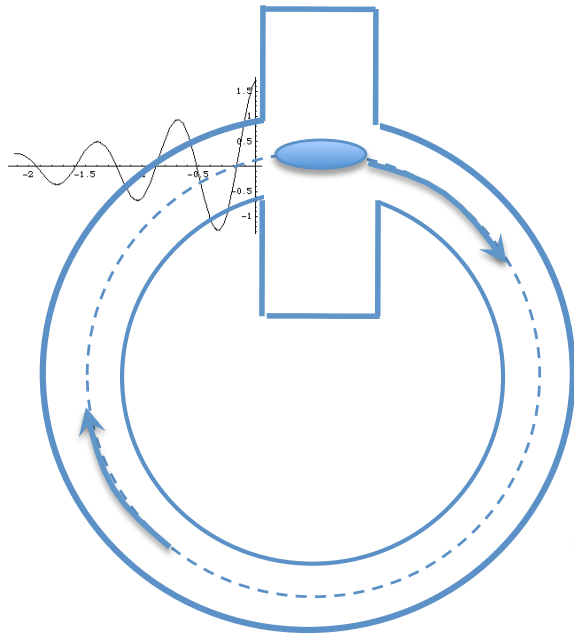

$$F_y = -\frac{Ne^2}{C}y(s)W_1(-d)$$

$$\frac{dy'}{ds} + \left(\frac{\omega_\beta}{c}\right)^2 y(s) = -\frac{Ne^2}{m_0\gamma c^2 C} \sum_{k=1}^{\infty} y(s - kC)W_1(-kC)$$

$$y \propto \exp\left(\frac{-i\Omega s}{c}\right) \Rightarrow$$

$$\begin{aligned} \Omega^2 - \omega_\beta^2 &= \frac{Ne^2}{m_0\gamma C} \sum_{k=1}^{\infty} \exp(ik\Omega T_0)W_1(-kC) \\ &= -i\frac{Ne^2}{m_0\gamma CT_0} \sum_{p=-\infty}^{\infty} Z_1^\perp(p\omega_0 + \Omega) \end{aligned}$$

A. Single rigid bunch instability (II)

- There will be a complex tune shift
 - Real part gives the coherent tune shift caused by the interaction of the bunch with the localized impedance source on successive turns
 - Imaginary part gives growth/damping time of the coherent oscillation

$$\frac{\text{Re}[\Omega - \omega_\beta]}{\omega_0} = \Delta Q_{cx,y} \approx \frac{Ne^2 \bar{\beta}_{x,y}}{4\pi m_0 \gamma c C} \sum_{p=-\infty}^{\infty} \text{Im} [Z_1^\perp(p\omega_0 + \omega_\beta)]$$

$$\text{Im}(\Omega - \omega_\beta) = \tau^{-1} \approx -\frac{Ne^2 \bar{\beta}_{x,y}}{2m_0 \gamma C^2} \sum_{p=-\infty}^{\infty} \text{Re} [Z_1^\perp(p\omega_0 + \omega_\beta)]$$

A. Single rigid bunch instability (III)

- An interesting case is when there is only one narrow-band resonator acting on the beam

→ Its resonant frequency ω_r is very close to a multiple of ω_0 ($p\omega_0$)

→ Then stability depends on the tuning of the betatron frequency with respect to the resonator frequency

$$\tau^{-1} \approx -\frac{Ne^2\bar{\beta}_{x,y}}{2m_0\gamma C^2} \left(\text{Re} [Z_1^\perp(p\omega_0 + \Delta_\beta\omega_0)] - \text{Re} [Z_1^\perp(p\omega_0 - \Delta_\beta\omega_0)] \right)$$

If $\Delta_\beta > 0$ (tune above the integer), beam is stable when $p\omega_0 < \omega_r$

If $\Delta_\beta < 0$ (tune below the integer), beam is stable when $p\omega_0 > \omega_r$

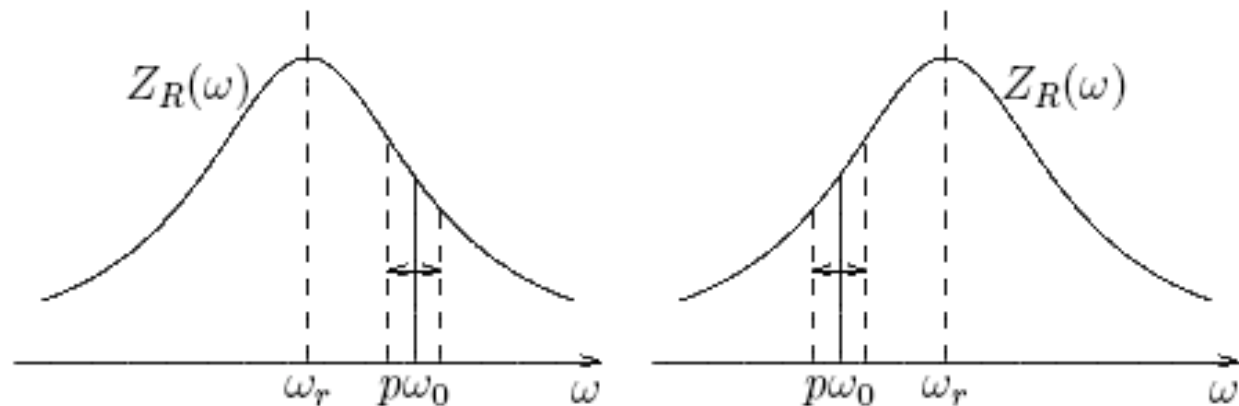

A. Single rigid bunch instability (longitudinal)

- There is an equivalent longitudinal of this type of instability, which is called **Robinson instability**. It has an intuitive explanation
 - When a bunch above transition is executing longitudinal dipole oscillations, it will have an **excess of energy when $\omega < \omega_0$**
 - If the cavity is tuned on **$\omega_r < p\omega_0$** the beam is stable because it will see a higher impedance (and therefore will lose more) when it is sitting on the **lower side-band**, i.e. when it has an excess of energy.
 - **Below transition** the situation is reversed.

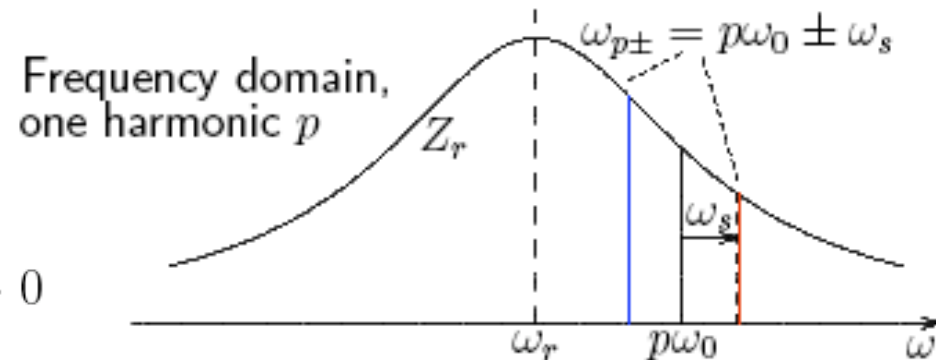

$$\epsilon = \hat{\epsilon} e^{-\alpha_s t} \sin(\omega_s t), \text{ damping if } \alpha_s > 0$$

$$\alpha_s = \frac{\omega_{s0} p I_p^2 (Z_r(\omega_{p+}) - Z_r(\omega_{p-}))}{2 I_0 h \hat{V} \cos \phi_s}$$

$$\gamma > \gamma_T, \cos \phi_s < 0, \text{ stable } Z_r(\omega_{p-}) > Z_r(\omega_{p+})$$

C. Single non-rigid bunch modes (Head-tail modes)

- A bunch can also become unstable because one or more of its intrinsic modes of oscillation are driven unstable by an external wake field/impedance

→ Longitudinal modes are described by a longitudinal mode number, l

→ Transverse modes are described by a transverse mode number, m

Examples:

- $m=0, l=1$ dipole oscillation inside a bucket
- $m=1, l=0$ rigid dipole oscillation
- $m=1, l=1$ transverse dipole oscillation with head and tail of the bunch out of phase by π
-

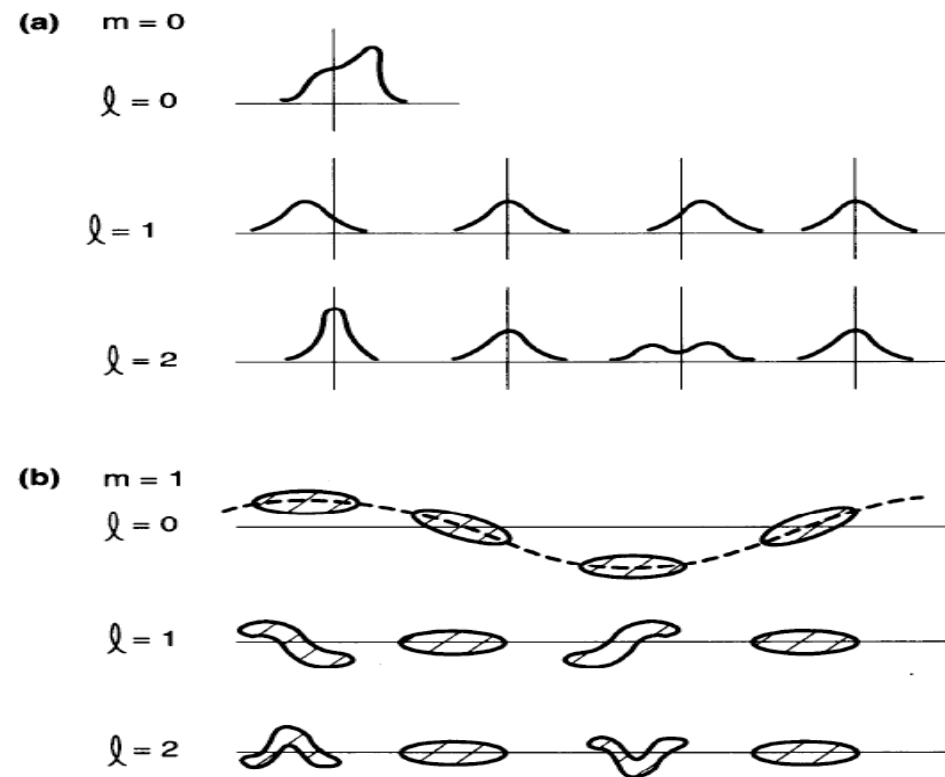

C. Head-tail modes seen by a wall current monitor

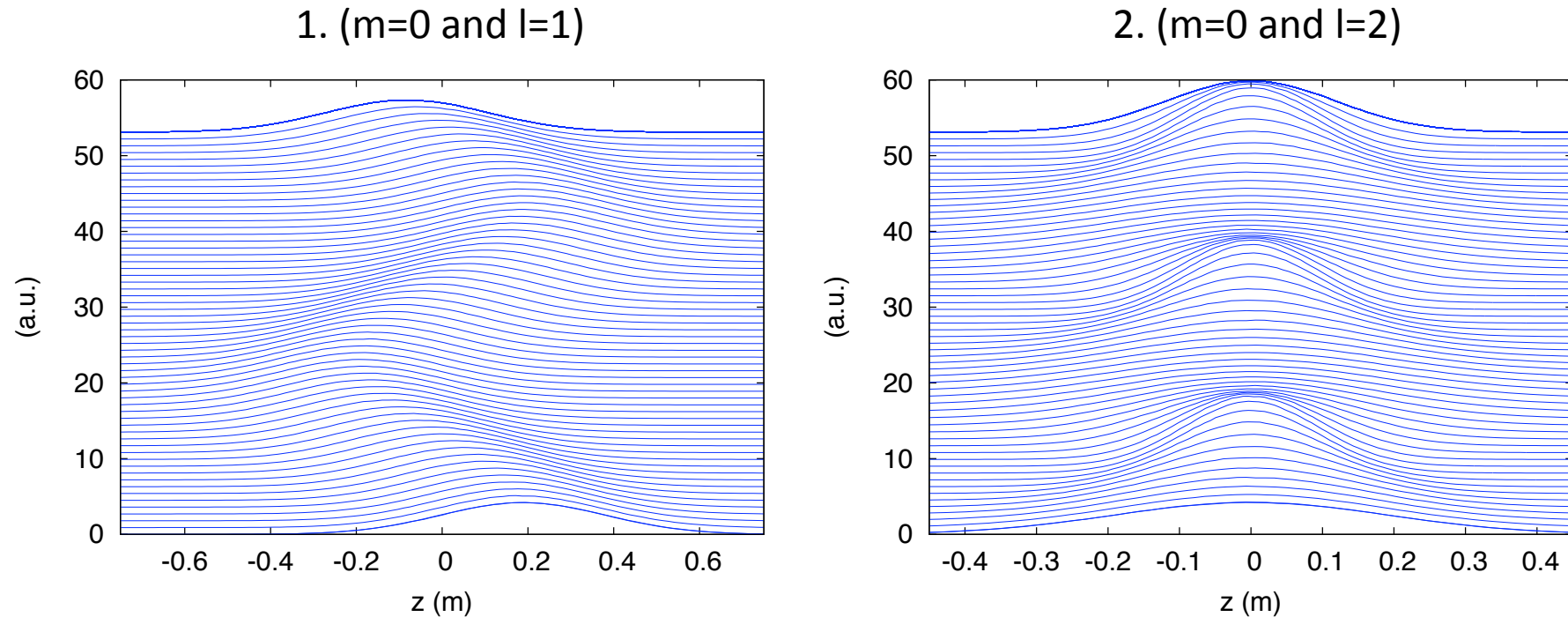

These are mountain range plots showing the evolution in time of the bunch shape

1. The bunch is executing a rigid dipole oscillation in the longitudinal phase space at the synchrotron frequency
2. The bunch is mismatched in the bucket and it executes a quadrupole oscillation in the longitudinal phase space at twice the synchrotron frequency

C. Head-tail modes seen at a wide-band pick-up (BPM)

- The patterns of the head-tail modes depend on chromaticity

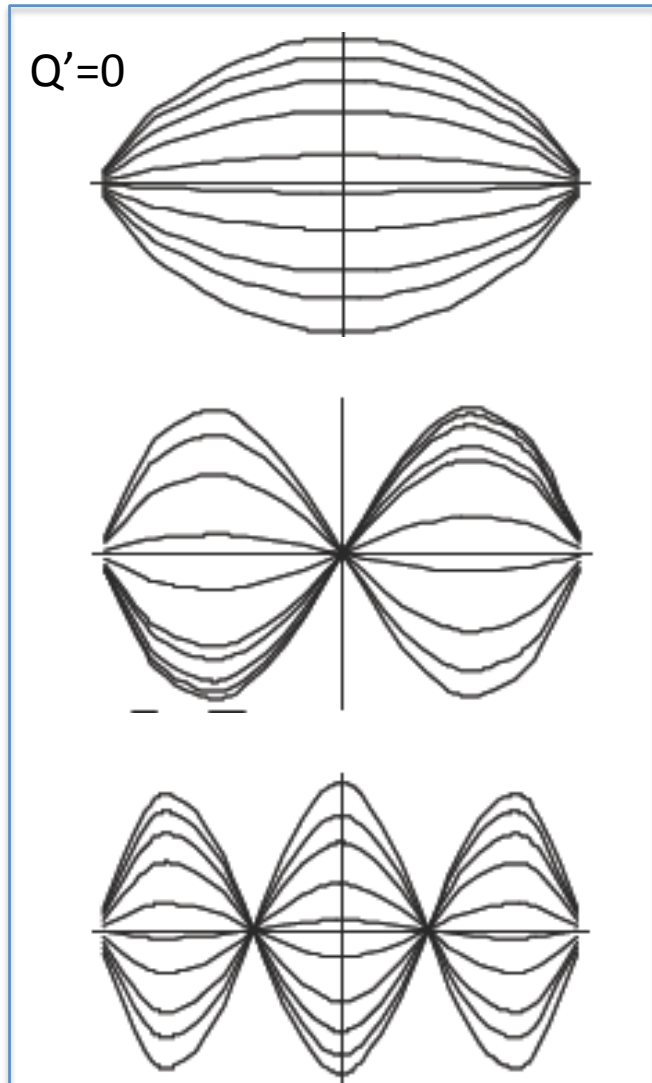

← $m=1$ and $l=0$ →

← $m=1$ and $l=1$ →

← $m=1$ and $l=2$ →

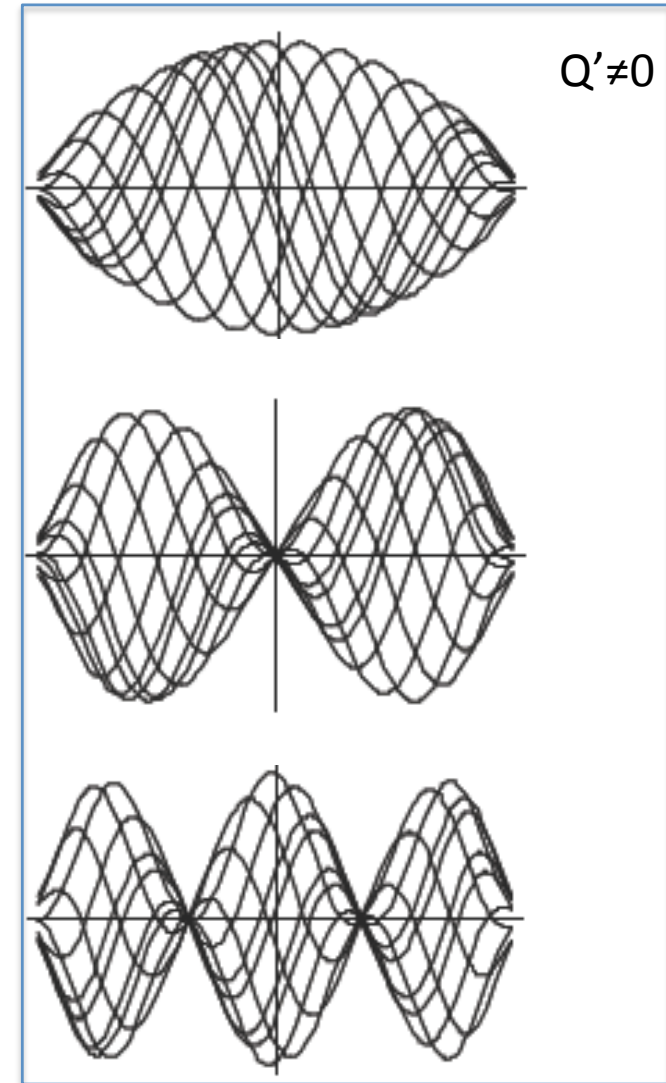

C. Head-tail modes seen at a wide-band pick-up (BPM)

$m=1$ and $l=0$

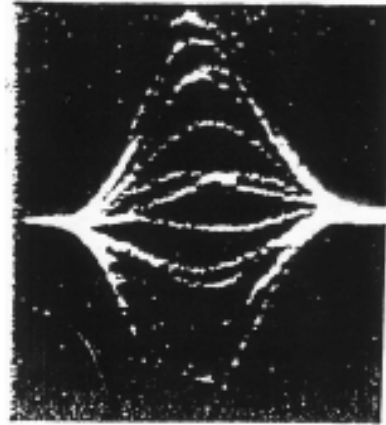

$Q' = 0$

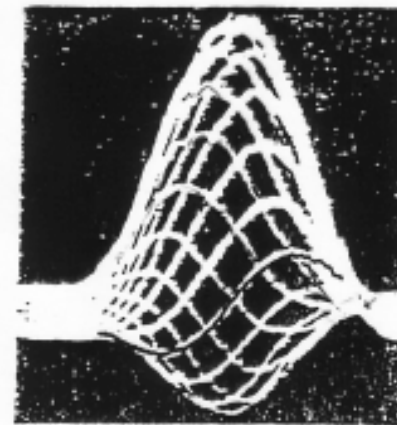

$Q' > 0$

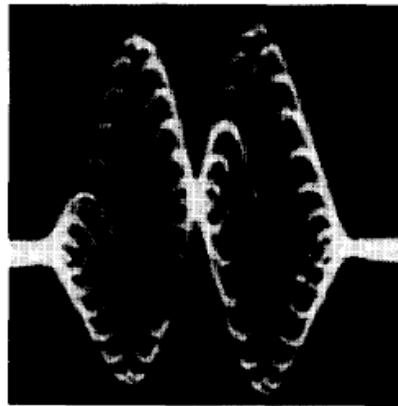

$l = 1$

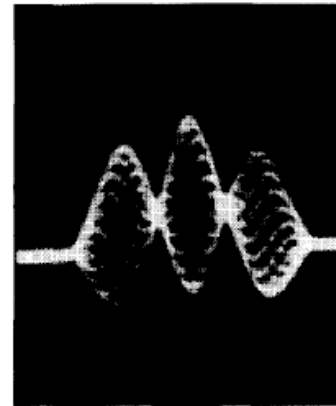

$l = 2$

Figure 6.32. Transverse beam oscillation modes observed at the CERN PS Booster. The head-tail phase χ is properly defined for the observed bunch shape. (Courtesy Jacques Gareyte, 1992).

C. Head-tail modes

- All the head-tail modes are affected by the **interaction of the bunch with an external impedance** and therefore oscillate at frequencies dependent on the bunch intensity

→ At very low intensity, where the influence of the impedance is small, they are multiples of the synchrotron frequency ($m=0$), or they cluster around the betatron frequency spaced by multiples of the synchrotron frequency ($m=1$)

$$\checkmark m\omega_\beta + l\omega_s$$

→ At „reasonably“ low intensities, the transverse modes ($m=1$) are:

- **Zero chromaticity** ($\xi=0$): all stable (neither growing nor damped)

- **Positive chromaticity** ($\xi>0$):

⇒ $l=0$ unstable and $|l|\geq 1$ stable below transition ($\eta<0$)

⇒ $l=0$ stable and $|l|\geq 1$ unstable above transition ($\eta>0$)

- **Negative chromaticity** ($\xi<0$):

⇒ $l=0$ stable and $|l|\geq 1$ unstable below transition ($\eta<0$)

⇒ $l=0$ unstable and $|l|\geq 1$ stable above transition ($\eta>0$)

→ As intensity increases, modes ($m=1, l$) shift due to the impedance, and there is an **intensity threshold** at which two of them ($l\leq 0$) couple and become unstable (**Transverse Mode Coupling Instability**)

C. Head-tail modes

- Typical pictures of modes shifting and coupling with intensity ($m=1$)
 - ⇒ Left picture: text book case, short bunch (calculation from Vlasov equation)
 - ⇒ Right picture: SPS case, long bunch (calculation + macroparticle simulation)

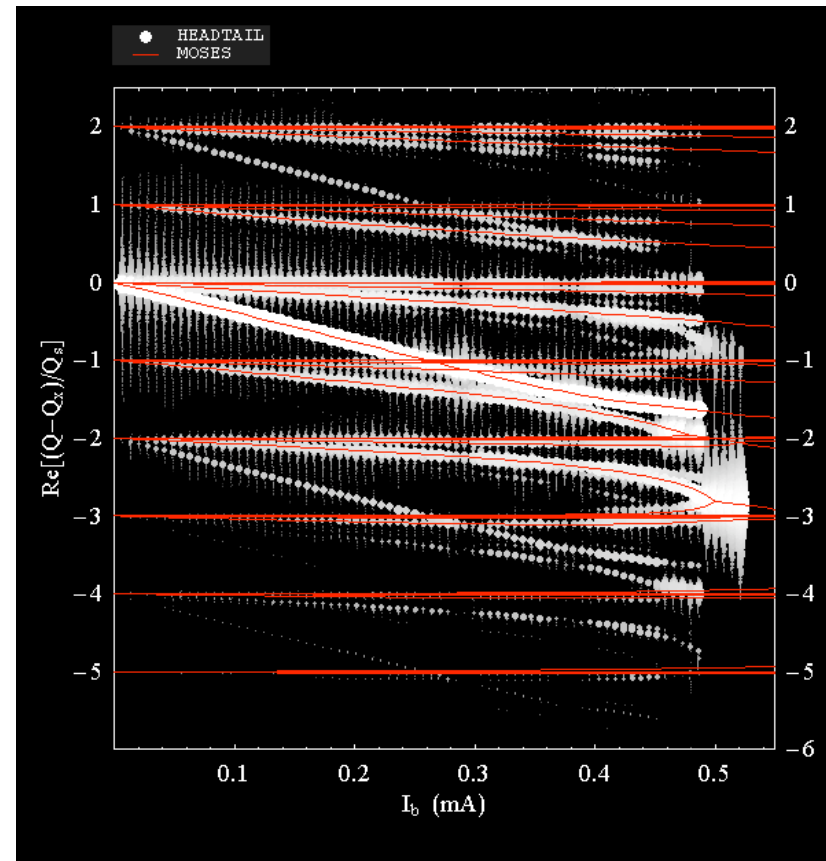
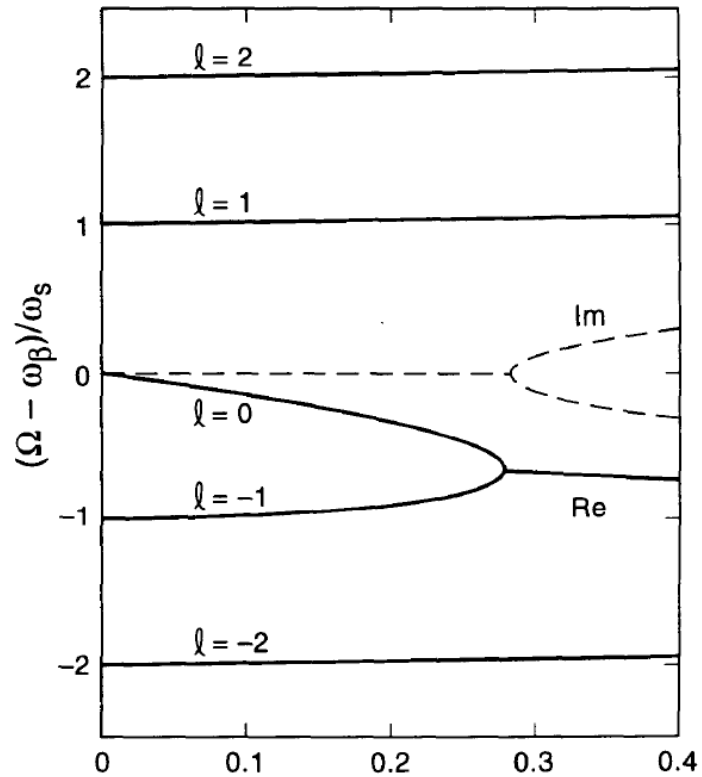

C. Head-tail modes

- The stability criterion of the mode $m=1, l=0$ can be understood qualitatively
 - Above transition particles rotate counterclockwise in the longitudinal phase space and they lose betatron phase going from head to tail ($\Delta p/p_0 > 0$ and $Q' < 0$, thus $\Delta Q < 0$)
 - The opposite happens below transition



Above transition energy:

$Q' = 0$: Going from head to tail or vice versa has same phase change. Phase lag and advance interchange, giving neither damping nor growth.

$Q' < 0$: Going from head to tail there is a loss in phase, going from tail to head a gain (picture), giving a systematic phase advance between head and tail and in average growth.

$Q' > 0$: Going from head to tail there is a phase gain, going back a loss, giving a systematic phase lag between head and tail and in average damping.

Below transition this situation is reversed.

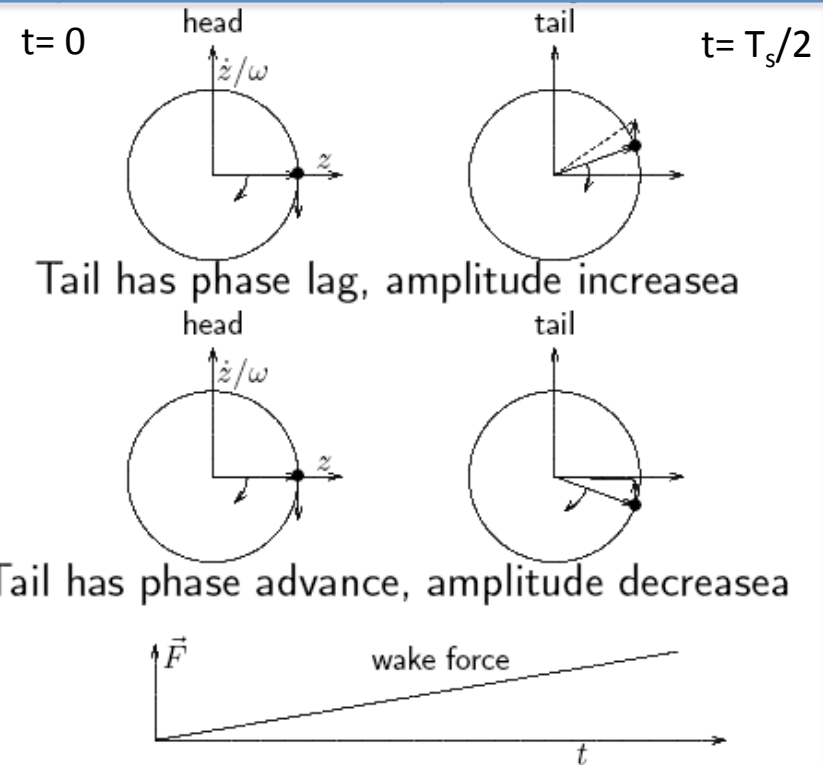

C. Head-tail modes

- For intensities well below the mode coupling threshold, the complex tune shift of the $m=1$ modes is given by an analytical formula
 - Valid for bunches with longitudinal Gaussian distribution
 - Real part for $l=0$ gives the coherent tune shift and imaginary part gives growth/damping rates of the different modes

$$\Omega^{(l)} - \omega_\beta - l\omega_s \approx -\frac{i}{4\pi} \frac{\Gamma(l + \frac{1}{2})}{2^l l!} \frac{Ne^2 \bar{\beta}_{x,y}}{m_0 \gamma C \sigma_z} \frac{\sum_{p=-\infty}^{\infty} Z_1^\perp(\omega') h_l(\omega' - \omega_\xi)}{\sum_{p=-\infty}^{\infty} h_l(\omega' - \omega_\xi)}$$

$$\omega' = p\omega_0 + \omega_{\beta x,y} + l\omega_s$$

$$\omega_\xi = \frac{\xi_{x,y} \omega_{\beta x,y}}{\eta}$$

Spectra of $h_l(\omega - \omega_\xi)$ and real and imaginary part of a broad-band impedance

