

Injection and extraction

- Kickers and septa
- Injection methods
 - Single-turn hadron injection
 - Injection errors, filamentation and blow-up
 - Multi-turn hadron injection
 - Charge-exchange H⁻ injection
 - Lepton injection
- Extraction methods
 - Single-turn (fast) extraction
 - Non-resonant multi-turn extraction
 - Resonant multi-turn (slow) extraction

Brennan Goddard (presented by Wolfgang Bartmann)

CERN

Injection, extraction and transfer

- An accelerator has limited dynamic range.
- Chain of stages needed to reach high energy
- Periodic re-filling of storage rings, like LHC

Beam transfer (into, out of, and between machines) is necessary.

LHC:	Large Hadron Collider
SPS:	Super Proton Synchrotron
AD:	Antiproton Decelerator
ISOLDE:	Isotope Separator Online Device
PSB:	Proton Synchrotron Booster
PS:	Proton Synchrotron
LINAC:	LINear Accelerator
LEIR:	Low Energy Ring
CNGS:	CERN Neutrino to Gran Sasso

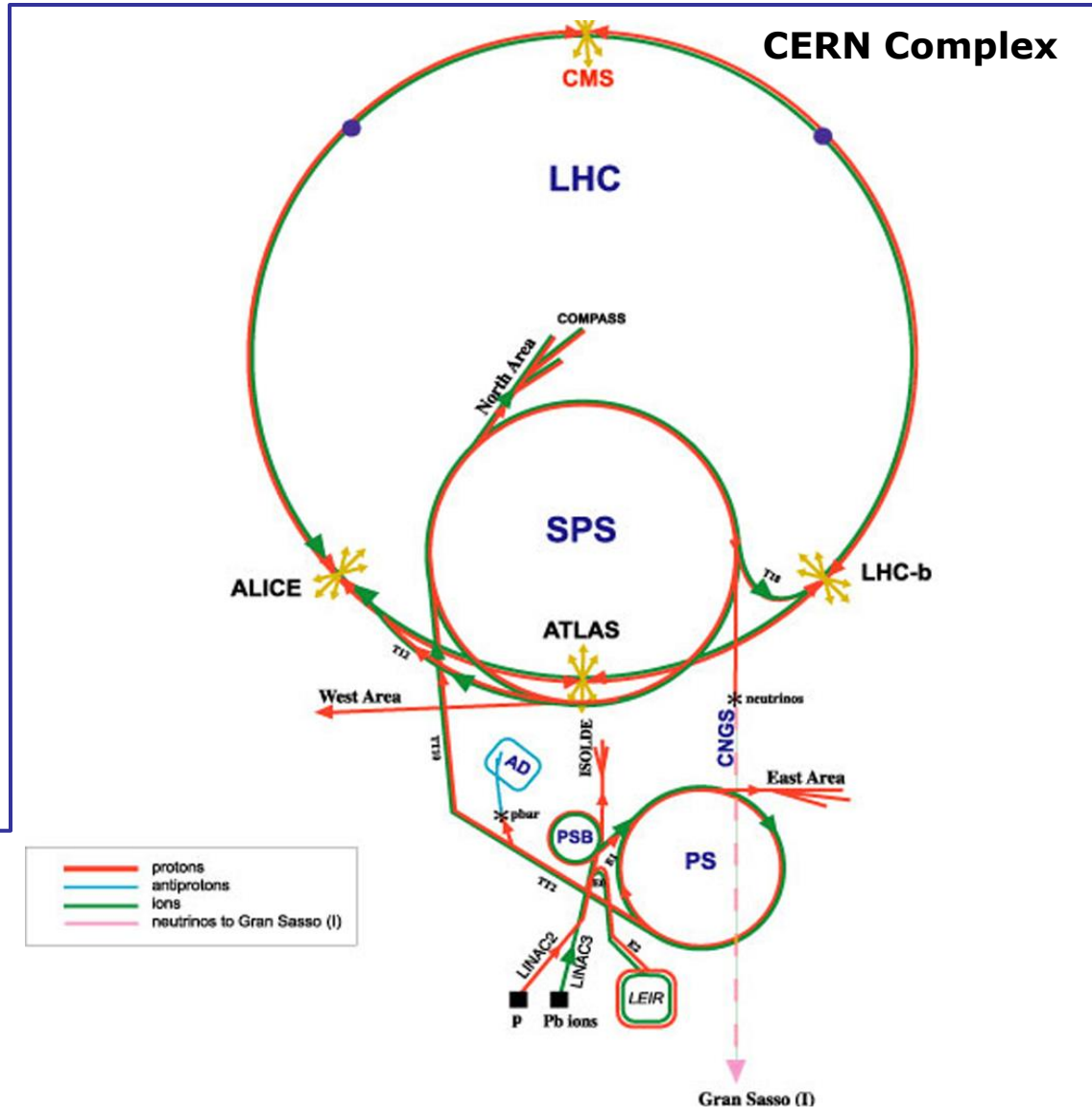

Kicker magnet

Pulsed magnet with very fast rise time
(100ns – few μ s)

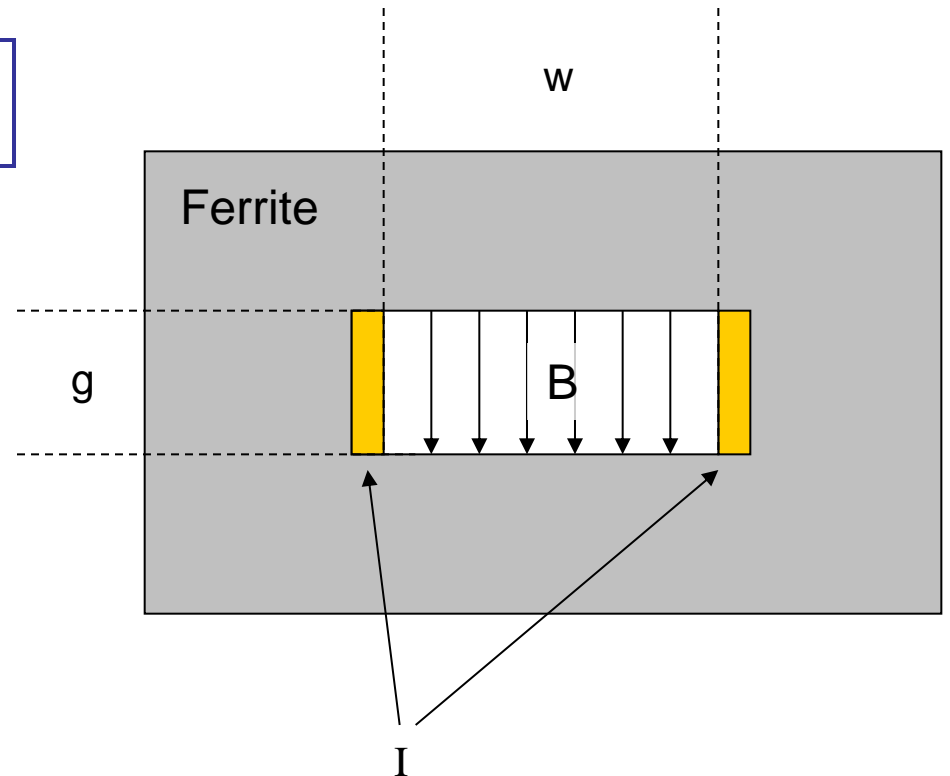

$$B = \mu_0 I / g$$

$$L = \mu_0 w l / g \quad (\text{magnet length } l)$$

$$dI/dt = V/L$$

Typically 3 kA in 1 μ s rise time

Magnetic septum

Pulsed or DC magnet with thin (2-20mm) septum between zero field and high field region

Septum coil

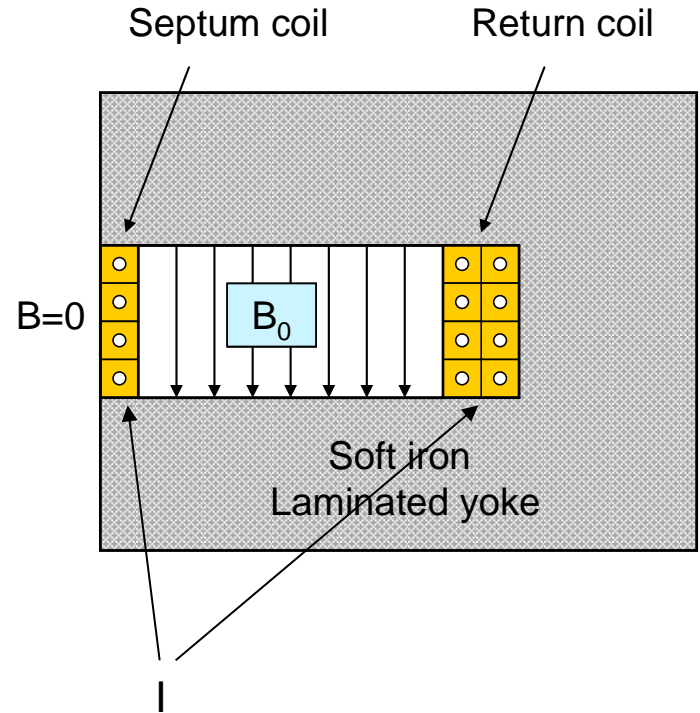
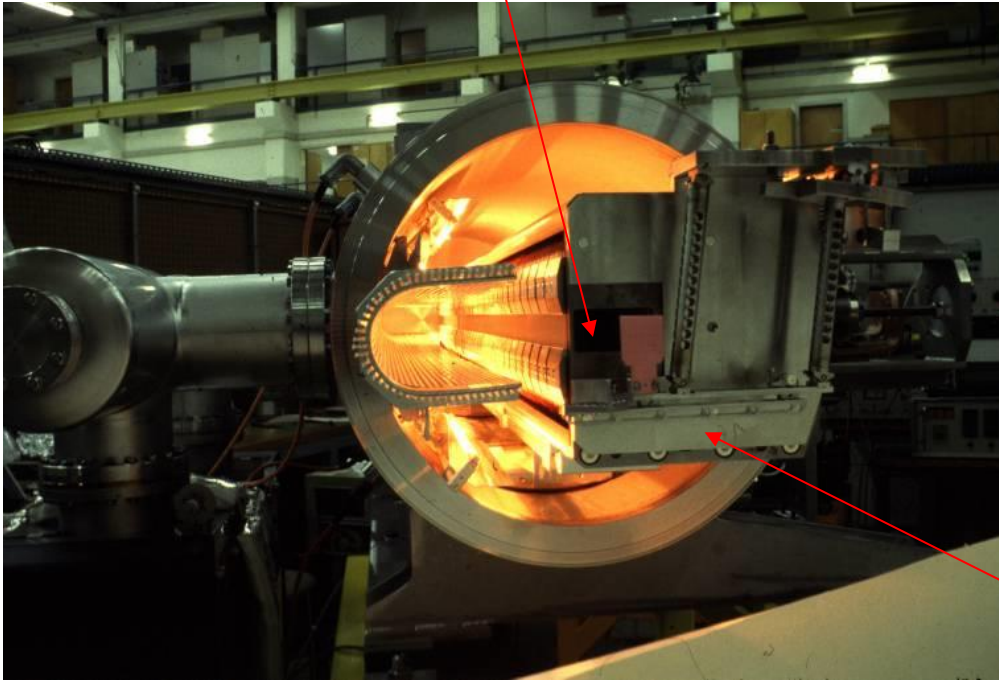

$$B_0 = \mu_0 I / g$$

Typically I 5-25 kA

Yoke

Electrostatic septum

DC electrostatic device with very thin (~ 0.1 mm) septum between zero field and high field region

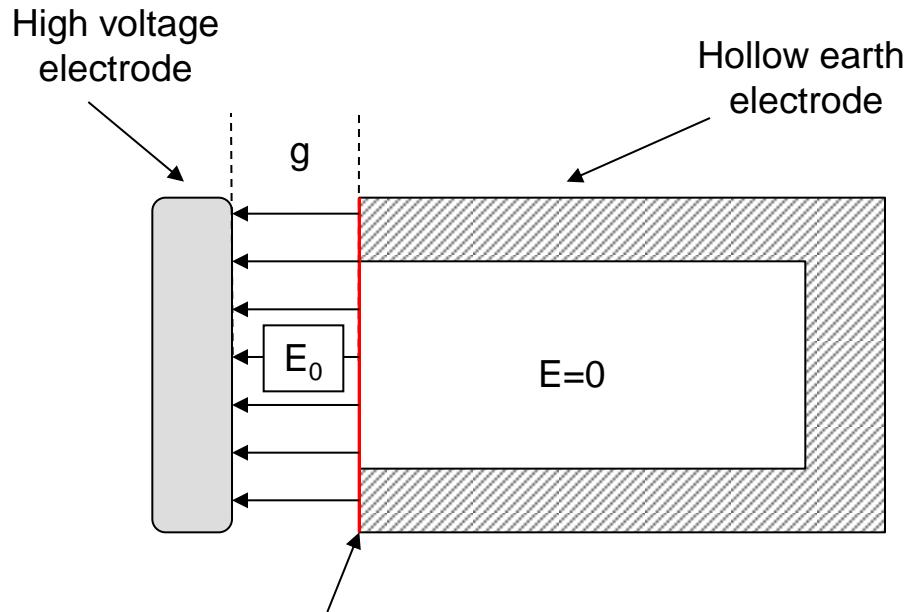

$$E = V / g$$

Typically $V = 200$ kV

$E = 100$ kV/cm

High Voltage
Electrode

Septum wires

Hollow earth
electrode

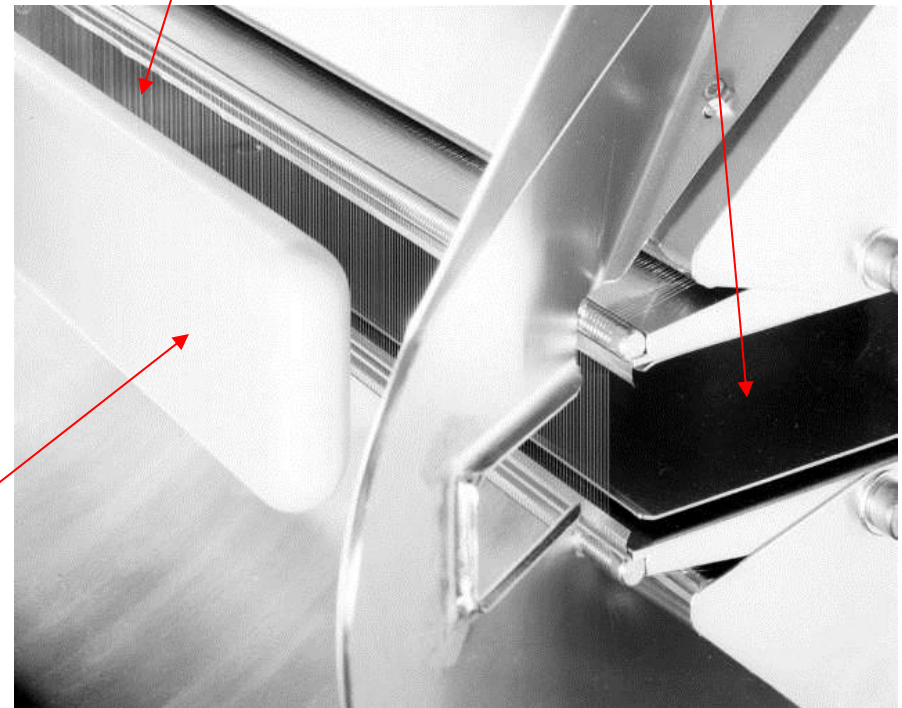

Normalised phase space

- Transform real transverse coordinates x, x' by

$$\begin{bmatrix} \bar{X} \\ \bar{X}' \end{bmatrix} = \mathbf{N} \cdot \begin{bmatrix} x \\ x' \end{bmatrix} = \sqrt{\frac{1}{\beta_s}} \cdot \begin{bmatrix} 1 & 0 \\ \alpha_s & \beta_s \end{bmatrix} \cdot \begin{bmatrix} x \\ x' \end{bmatrix}$$

$$\bar{X} = \sqrt{\frac{1}{\beta_s}} \cdot x$$

$$\bar{X}' = \sqrt{\frac{1}{\beta_s}} \cdot \alpha_s x + \sqrt{\beta_s} x'$$

Normalised phase space

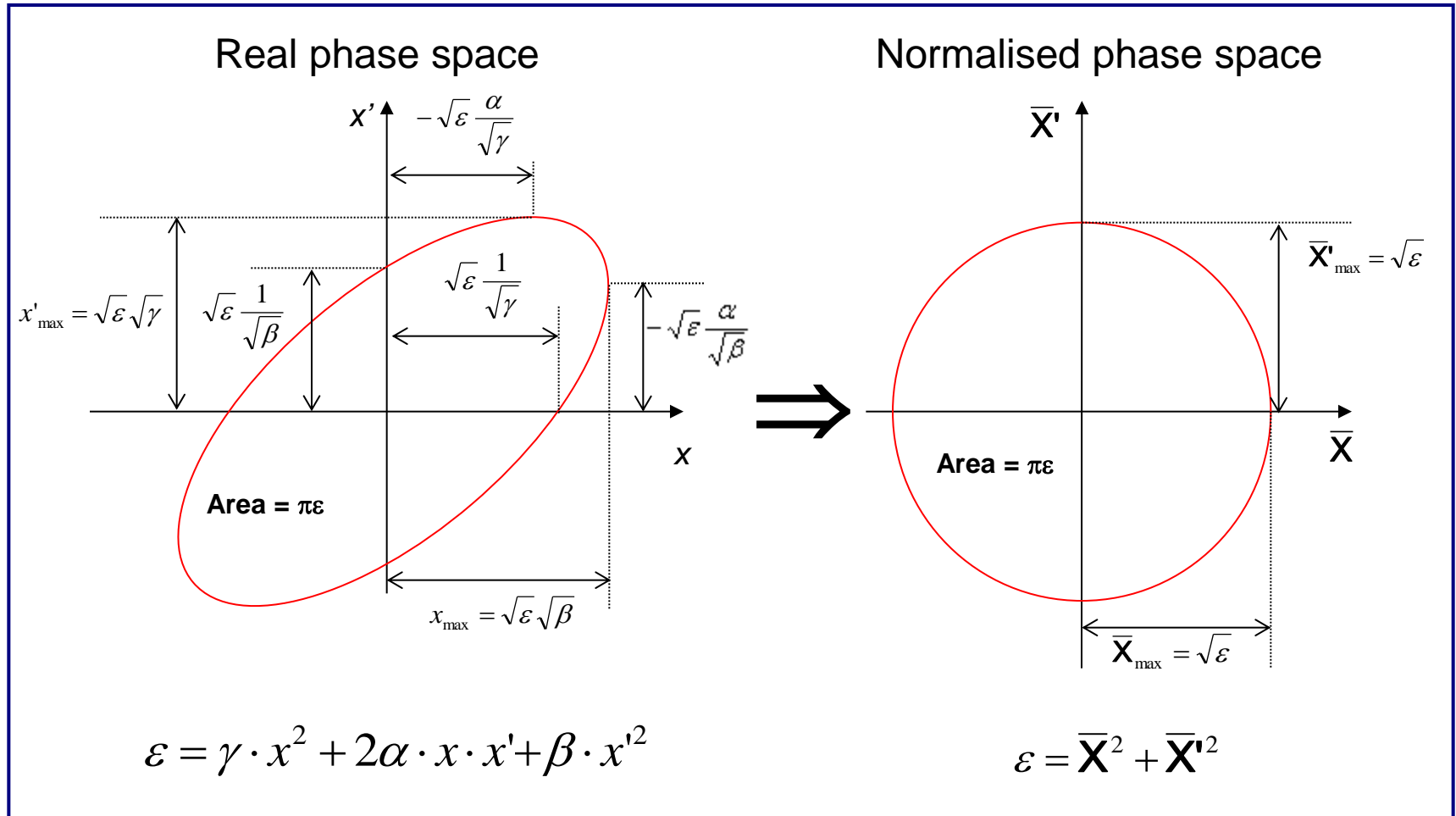

Single-turn injection – same plane

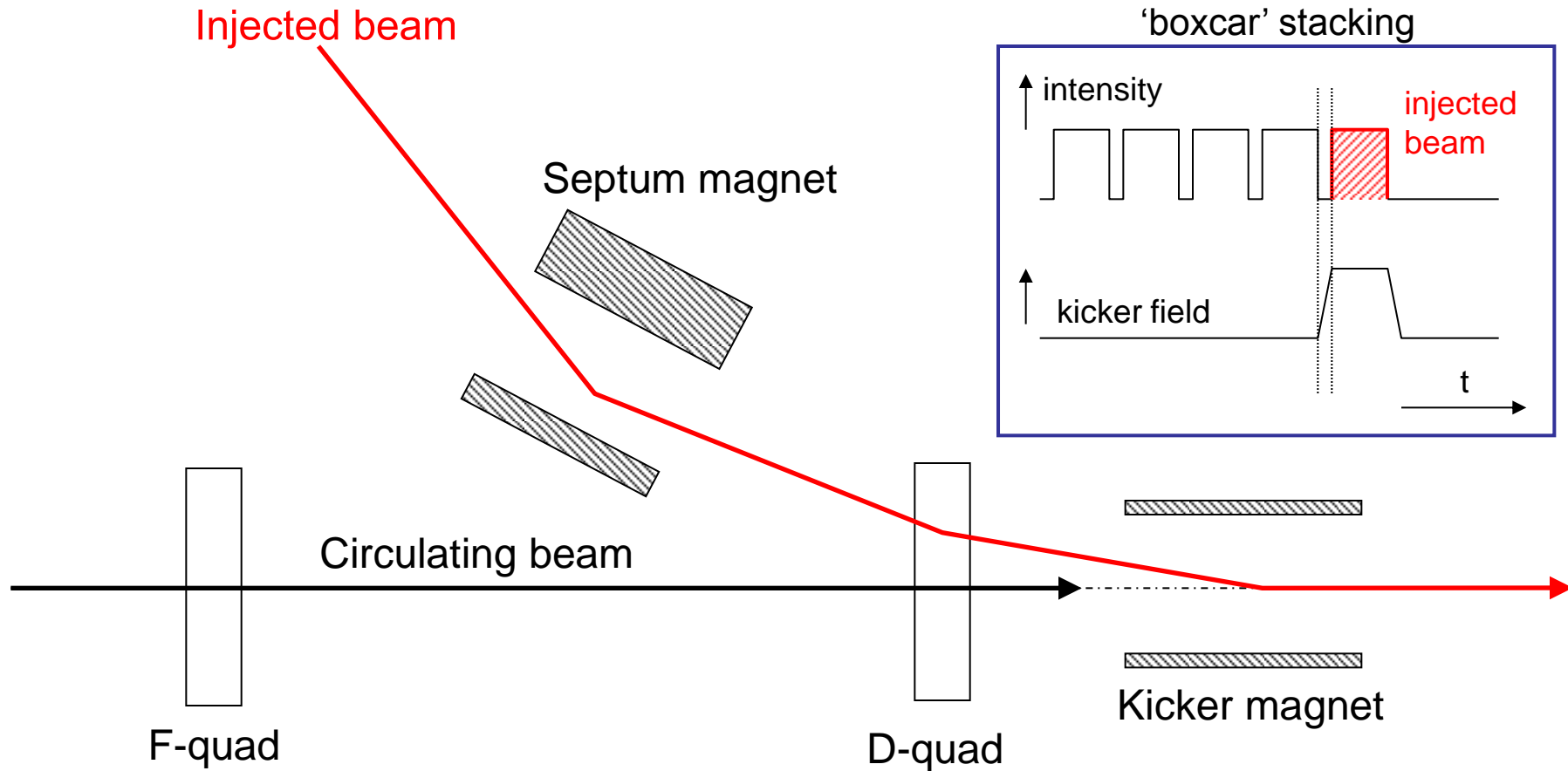

- Septum deflects the beam onto the closed orbit at the centre of the kicker
- Kicker compensates for the remaining angle
- Septum and kicker either side of D quad to minimise kicker strength

Single-turn injection

Normalised phase space at centre of idealised septum

Large deflection by septum

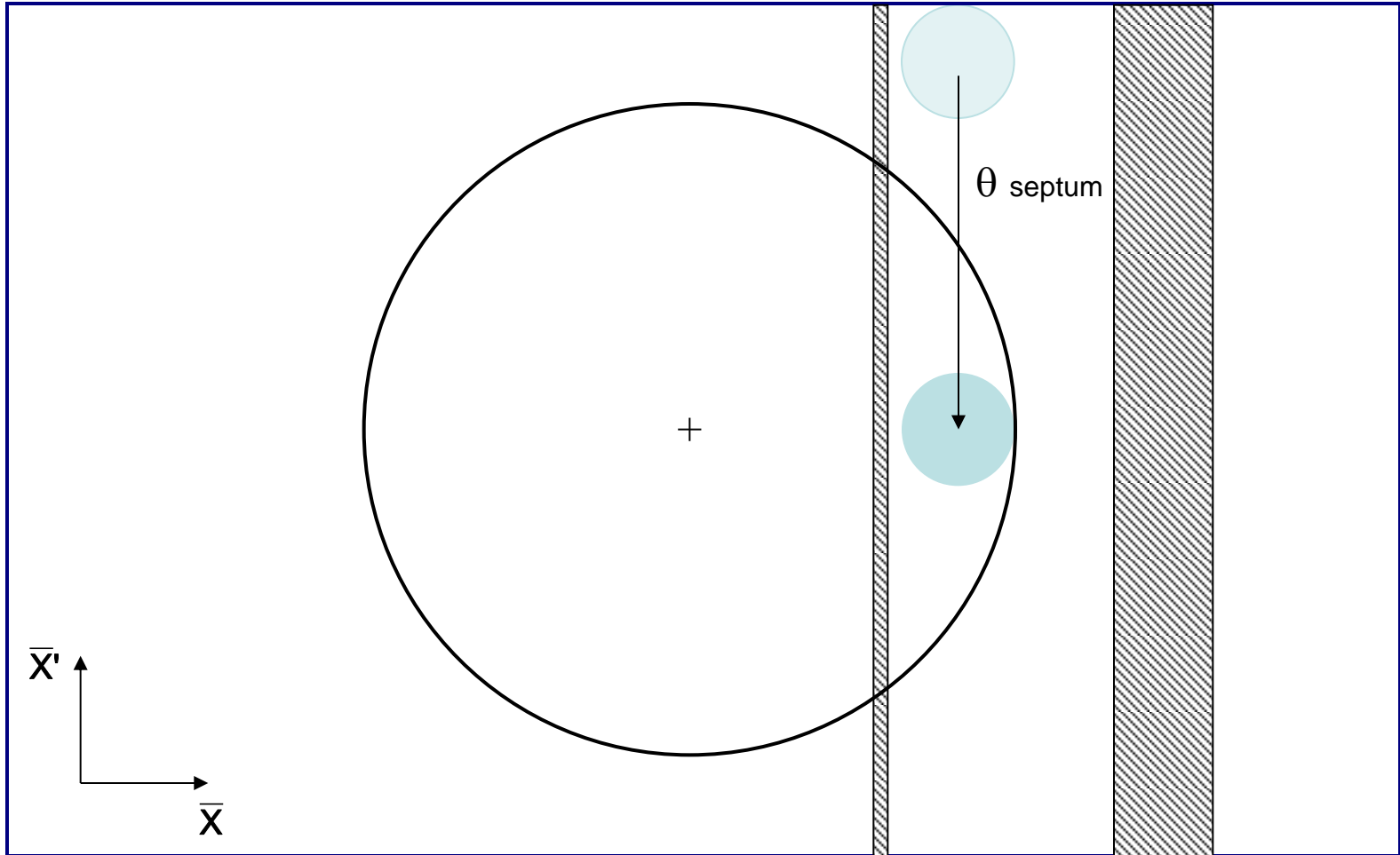

Single-turn injection

$\pi/2$ phase advance to kicker location

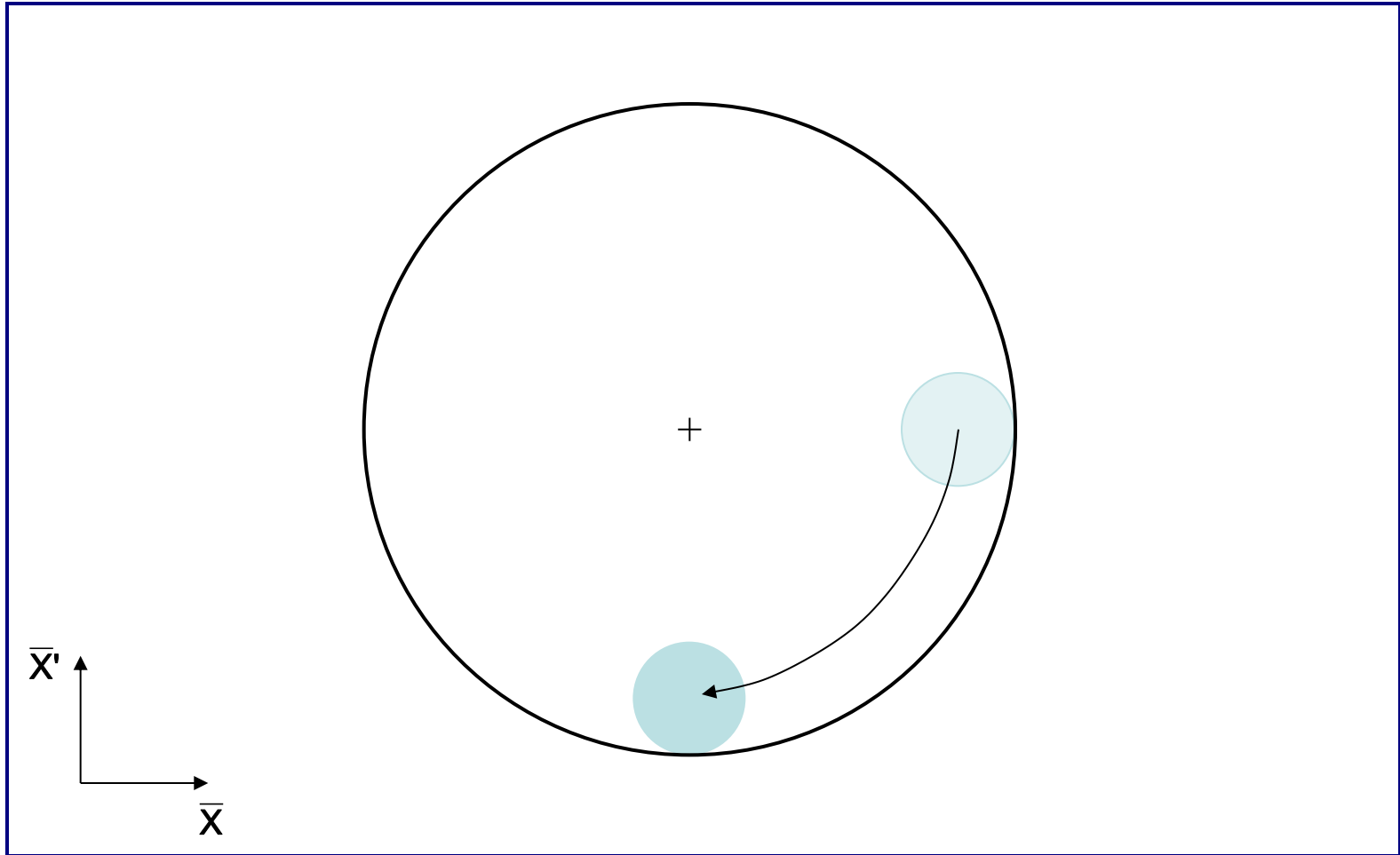

Single-turn injection

Normalised phase space at centre of idealised kicker

Kicker deflection places beam on central orbit

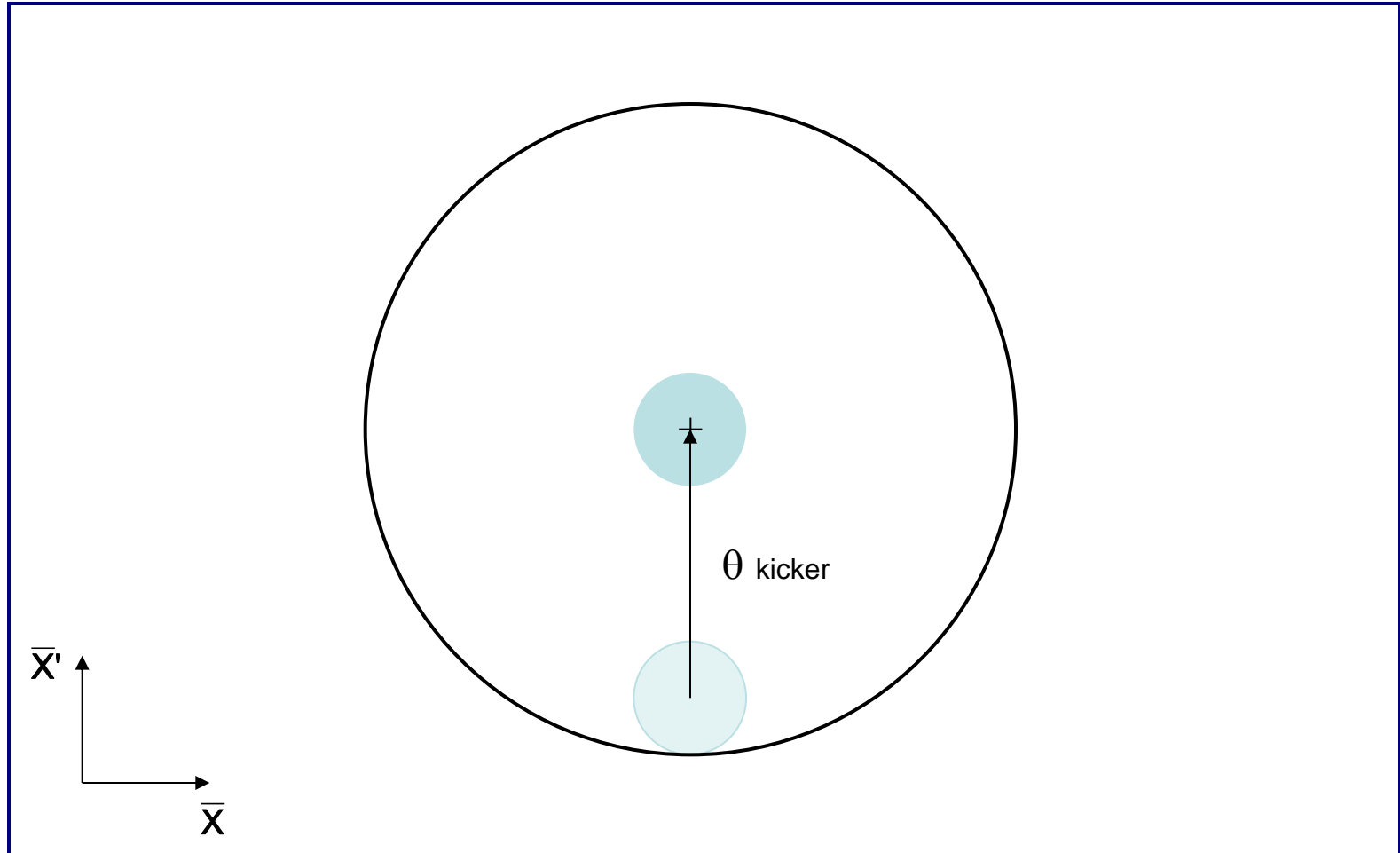

Injection oscillations

For imperfect injection the beam oscillates around the central orbit. 1

kicker θ error

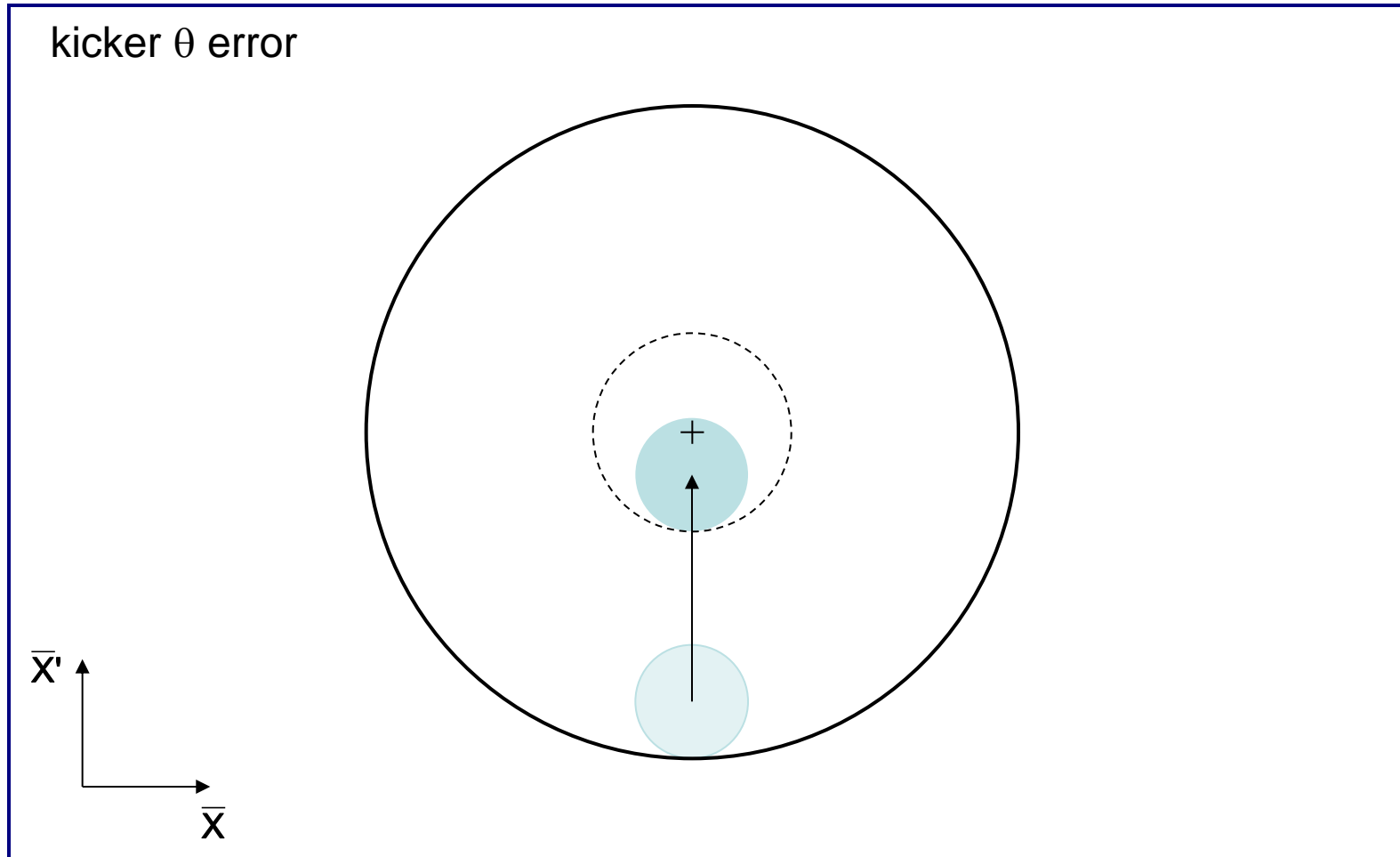

Injection oscillations

For imperfect injection the beam oscillates around the central orbit. 2

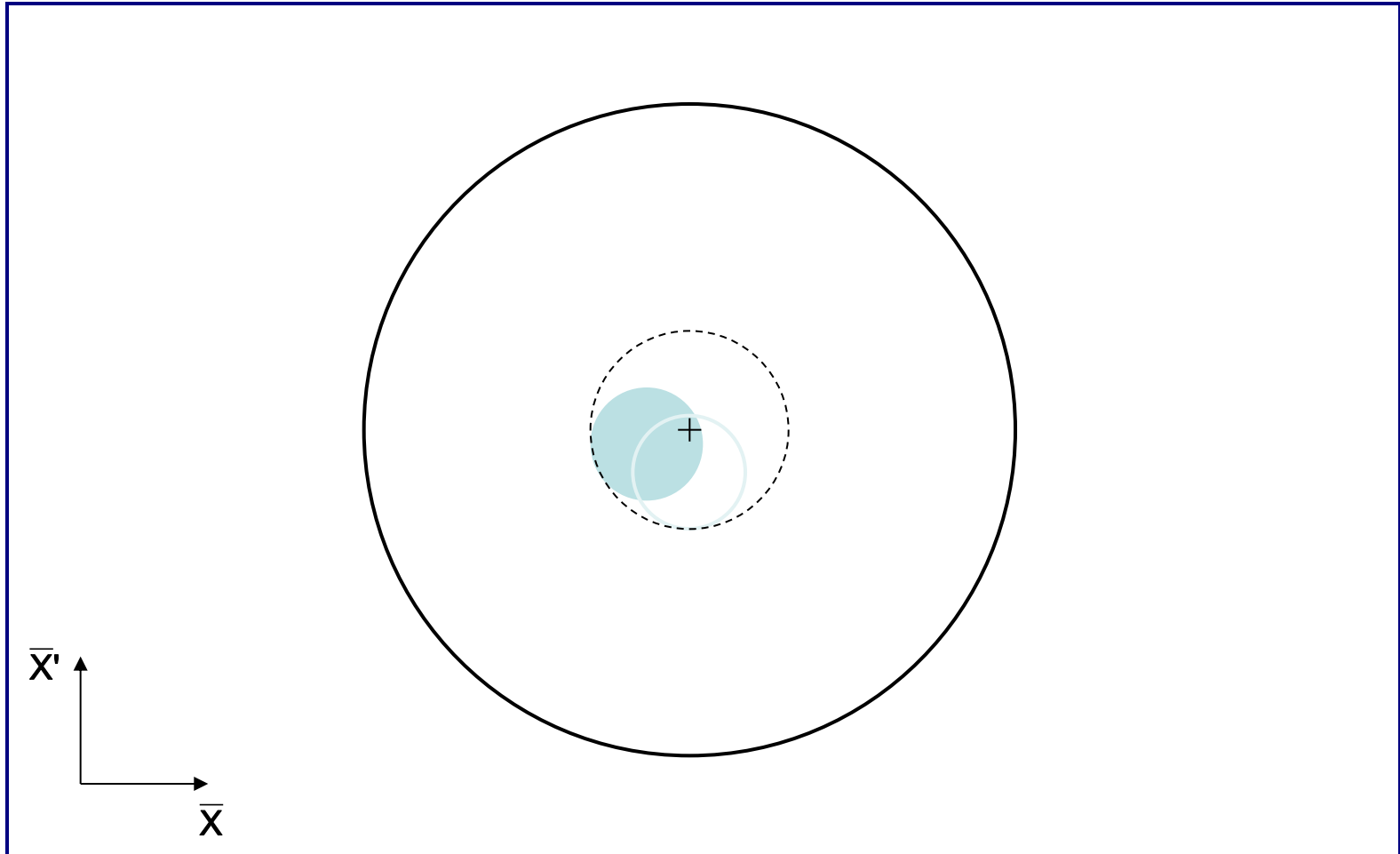

Injection oscillations

For imperfect injection the beam oscillates around the central orbit. 3

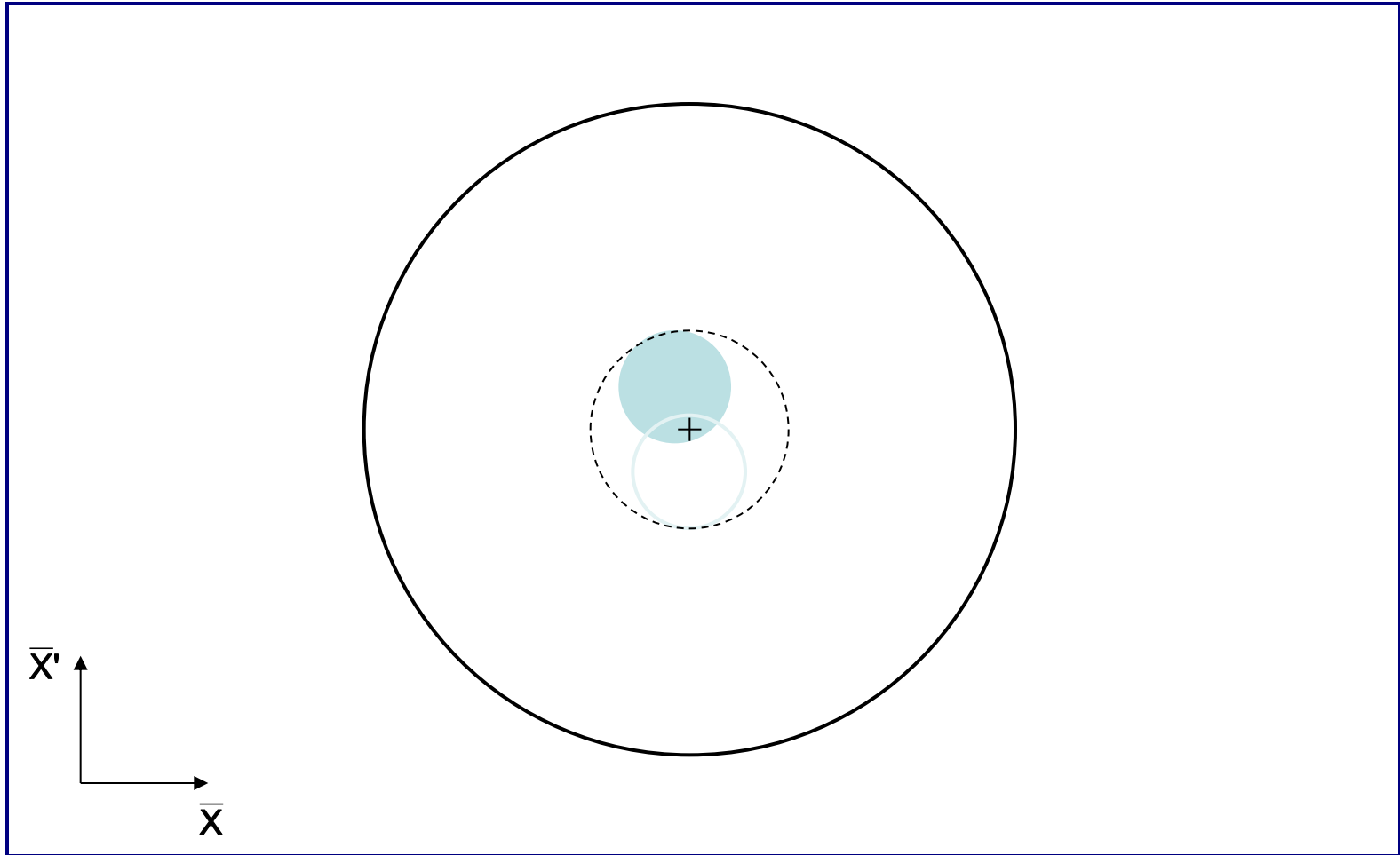

Injection oscillations

For imperfect injection the beam oscillates around the central orbit. 4

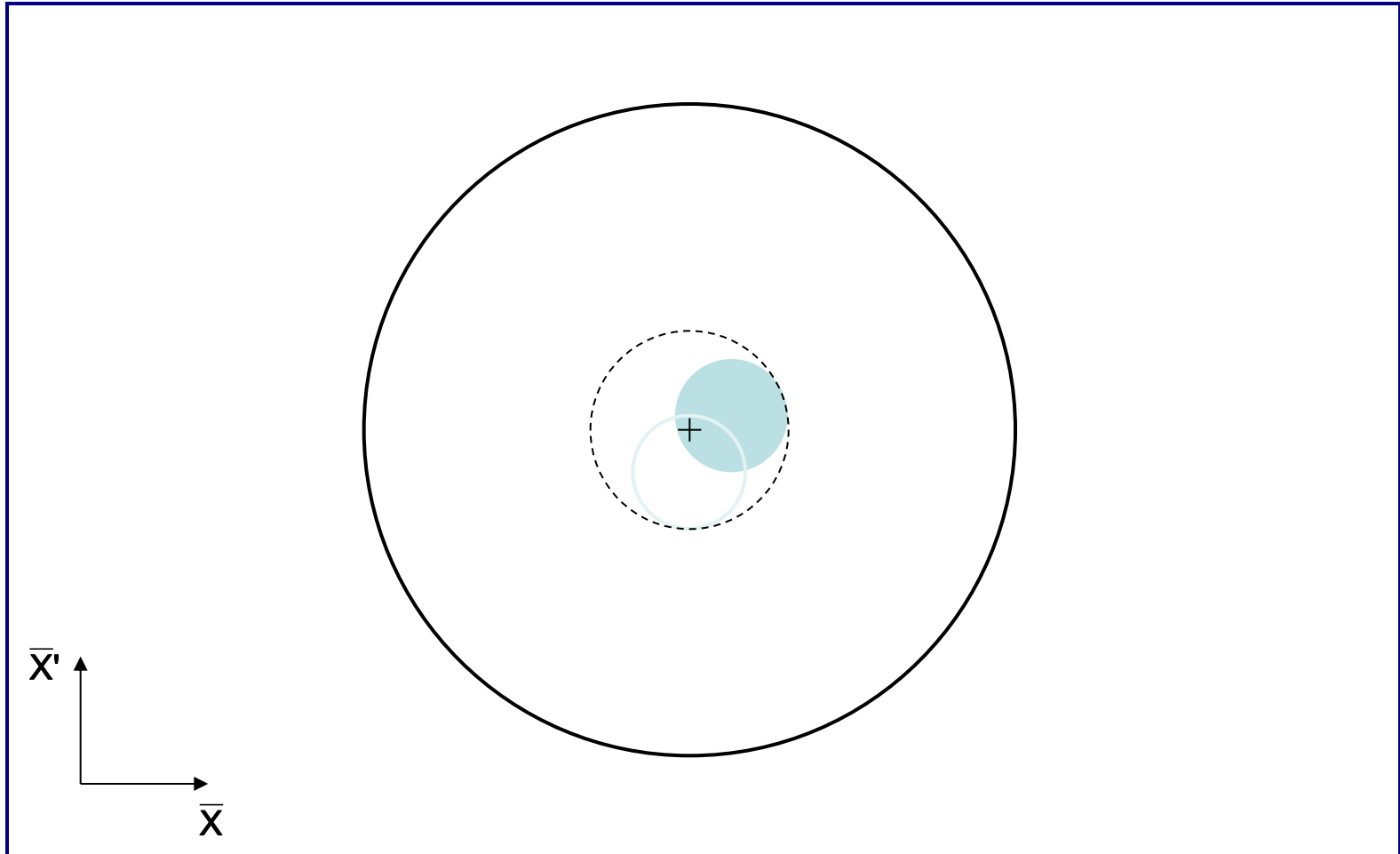

Injection oscillations

- Betatron oscillations with respect to the Closed Orbit

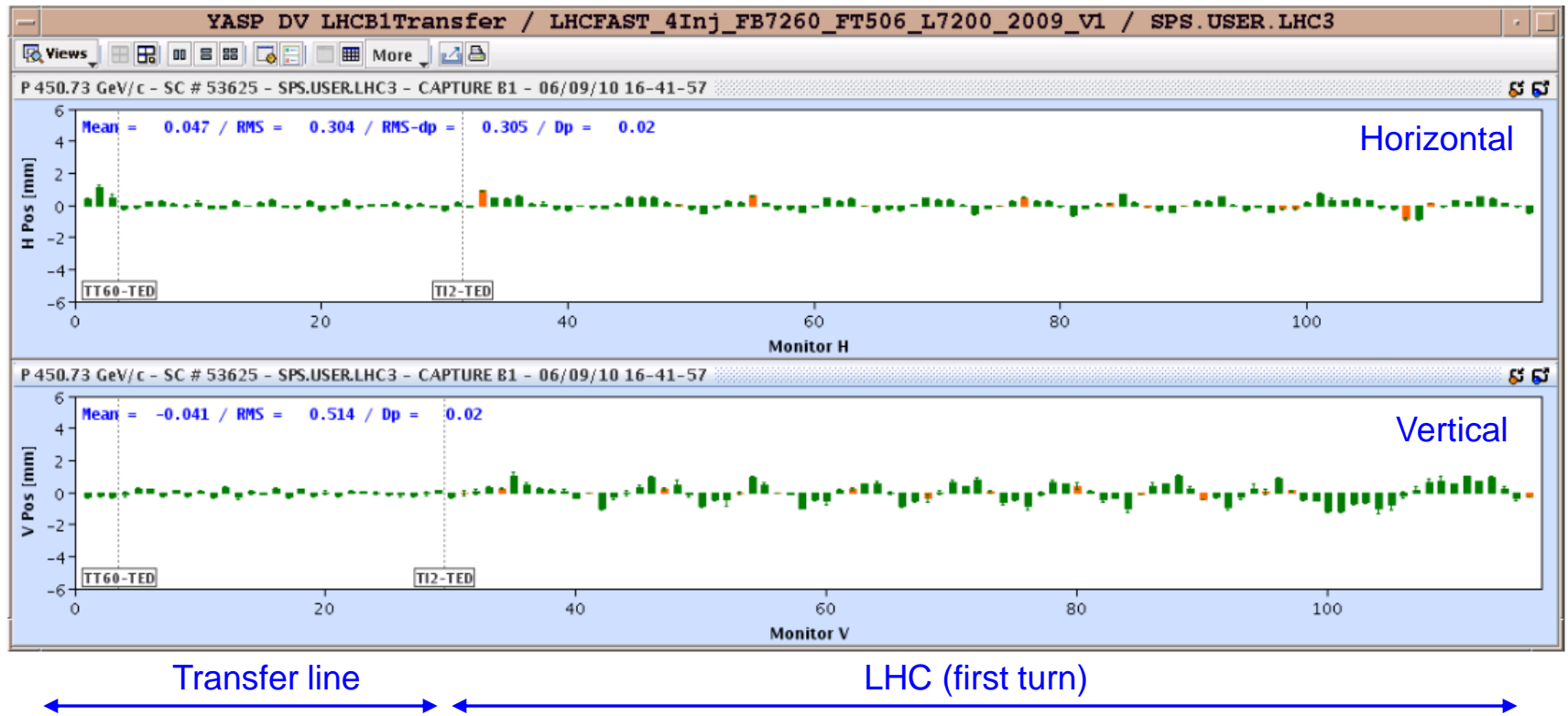

Filamentation

- Non-linear effects (e.g. magnetic field multipoles) present which introduce amplitude dependent effects into particle motion.
- Over many turns, a phase-space oscillation is transformed into an emittance increase.
- So any residual transverse oscillation will lead to an emittance blow-up through filamentation
 - “Transverse damper” systems used to damp injection oscillations - bunch position measured by a pick-up, which is linked to a kicker

Filamentation

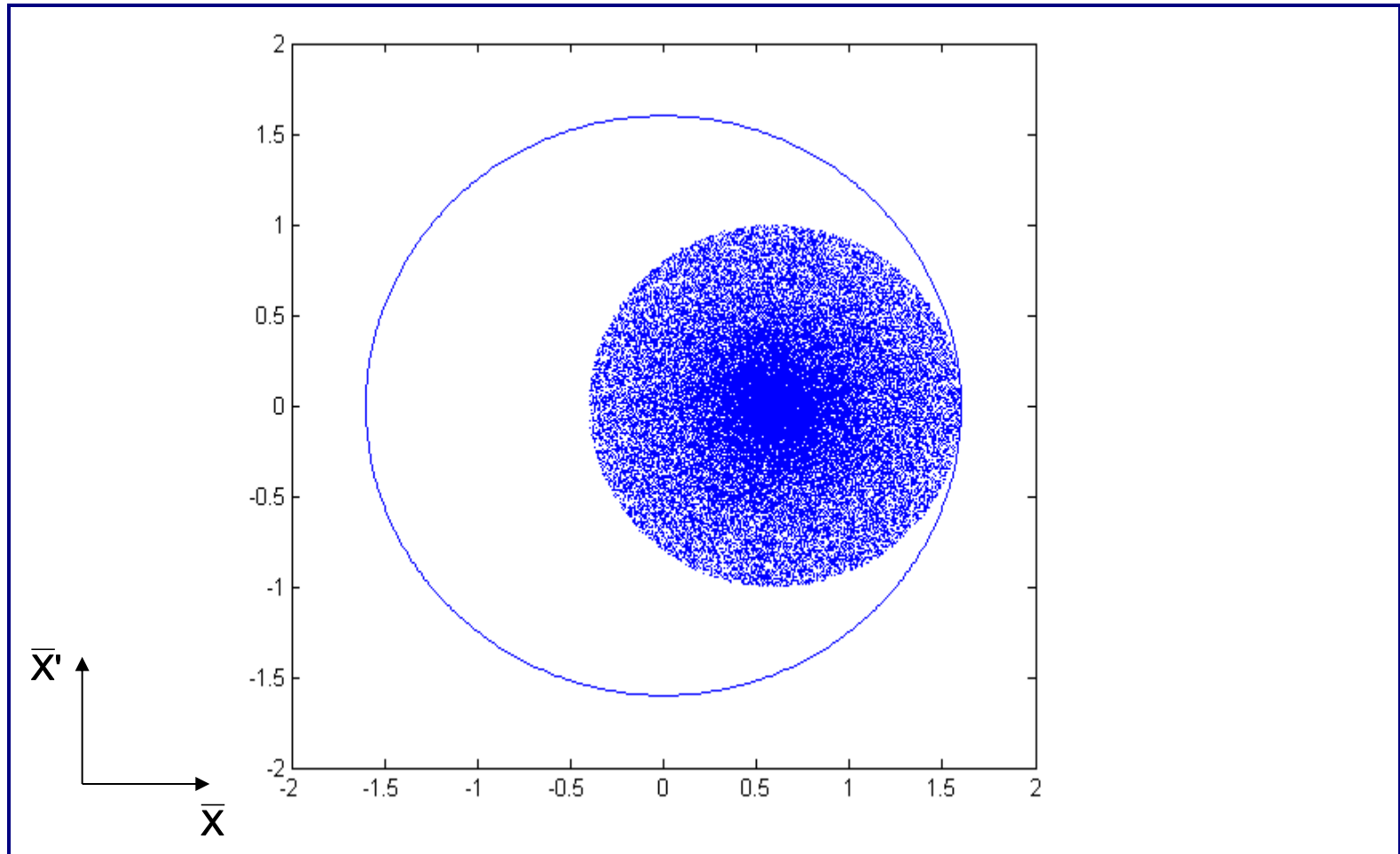

Filamentation

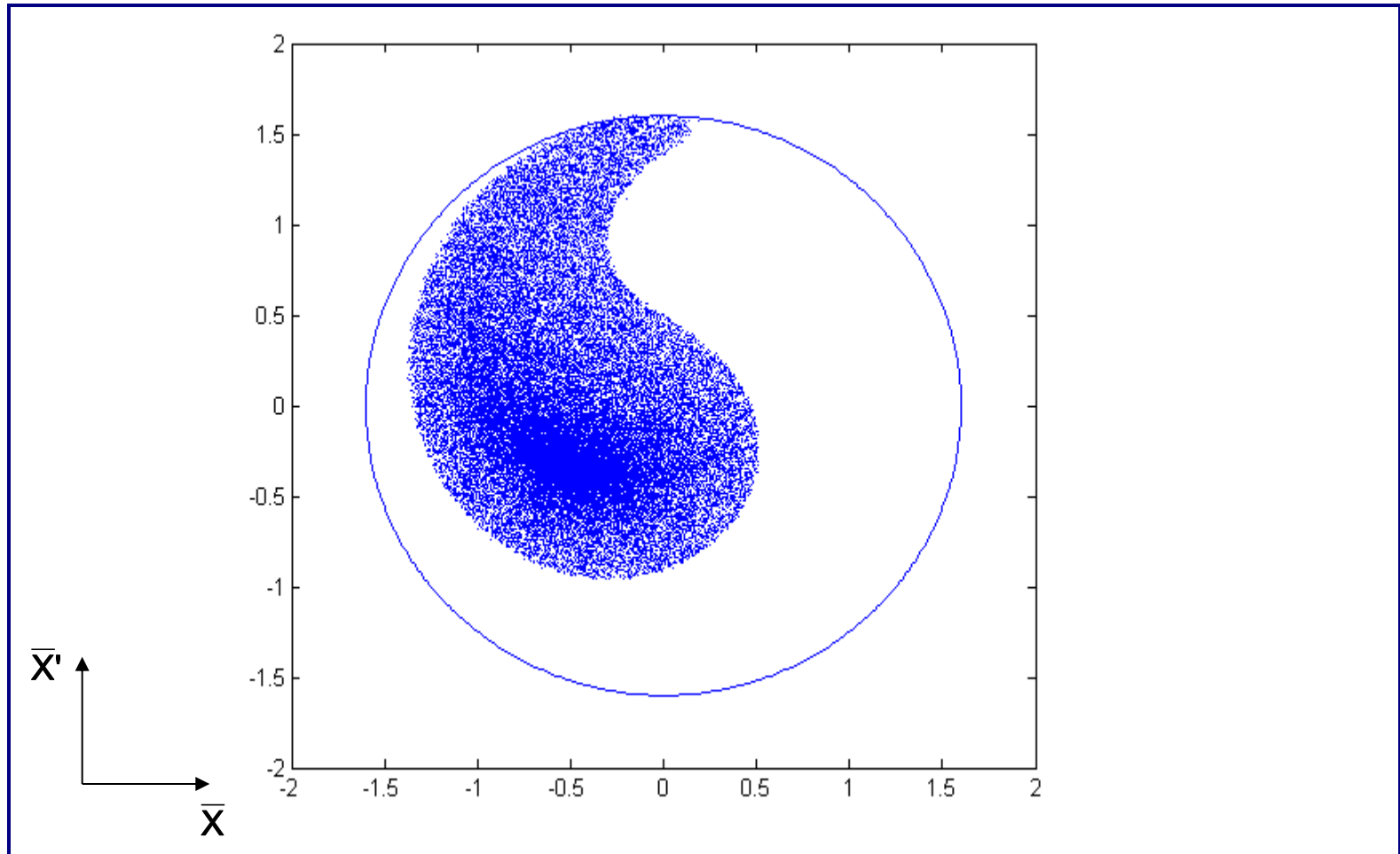

Filamentation

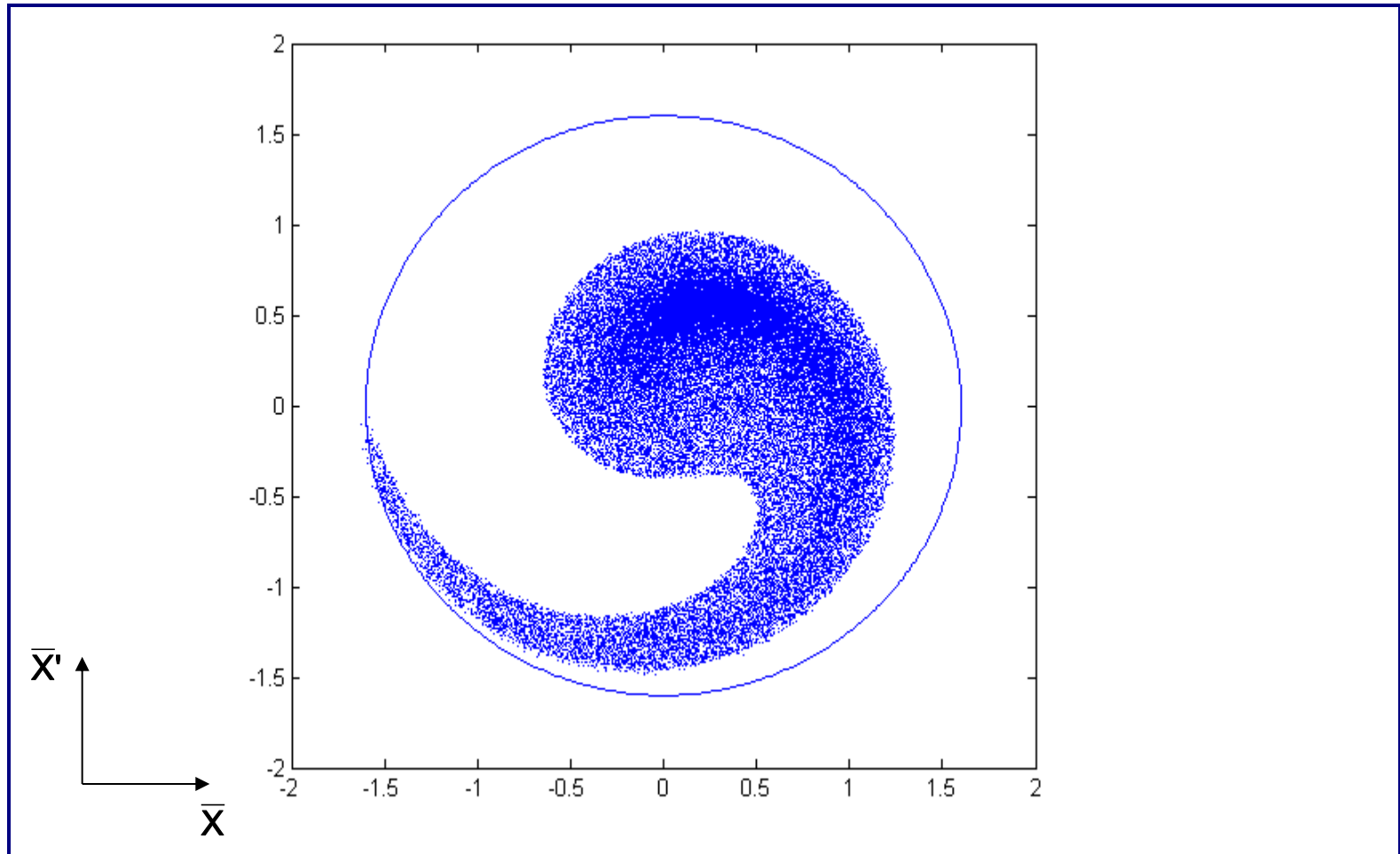

Filamentation

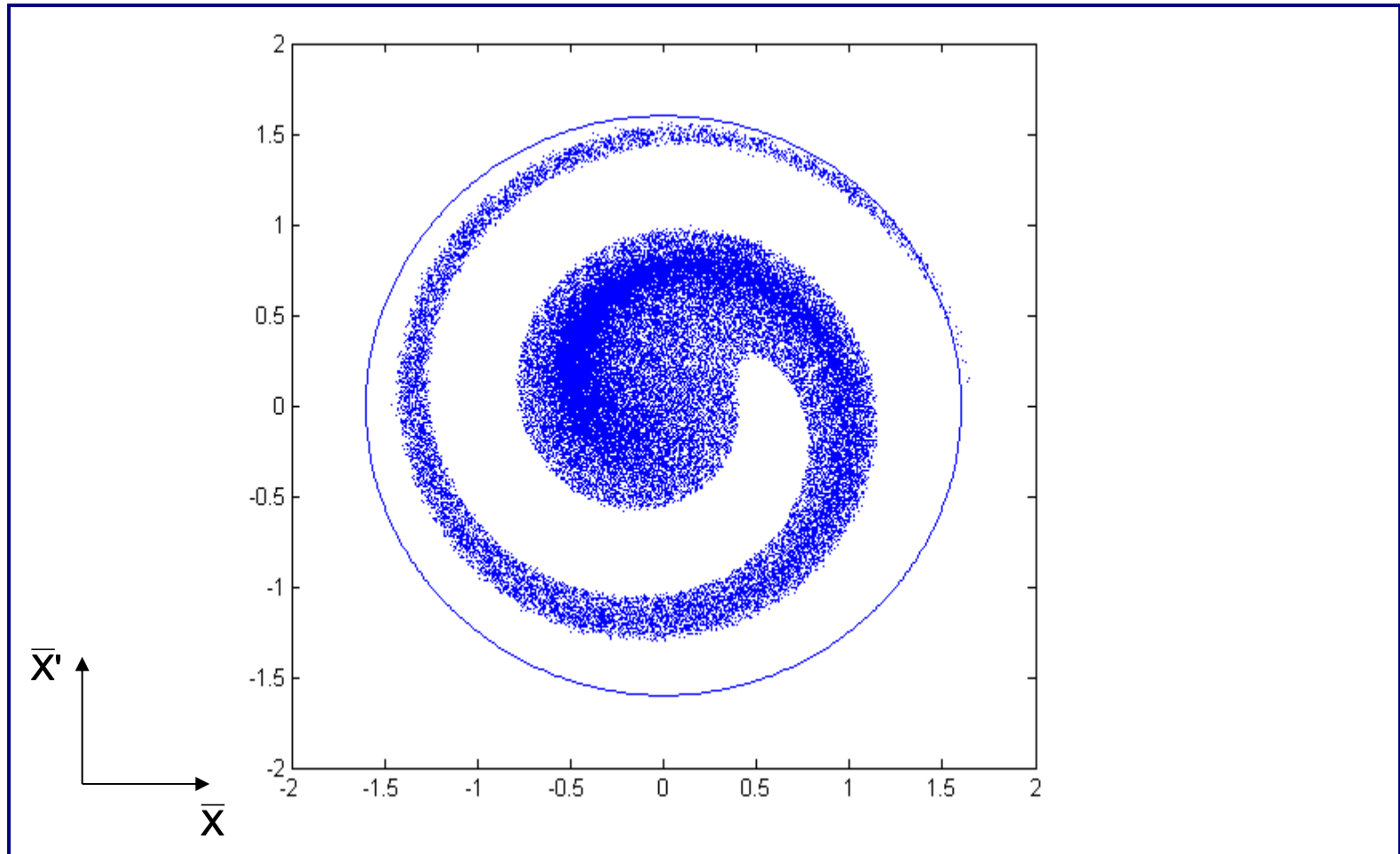

Filamentation

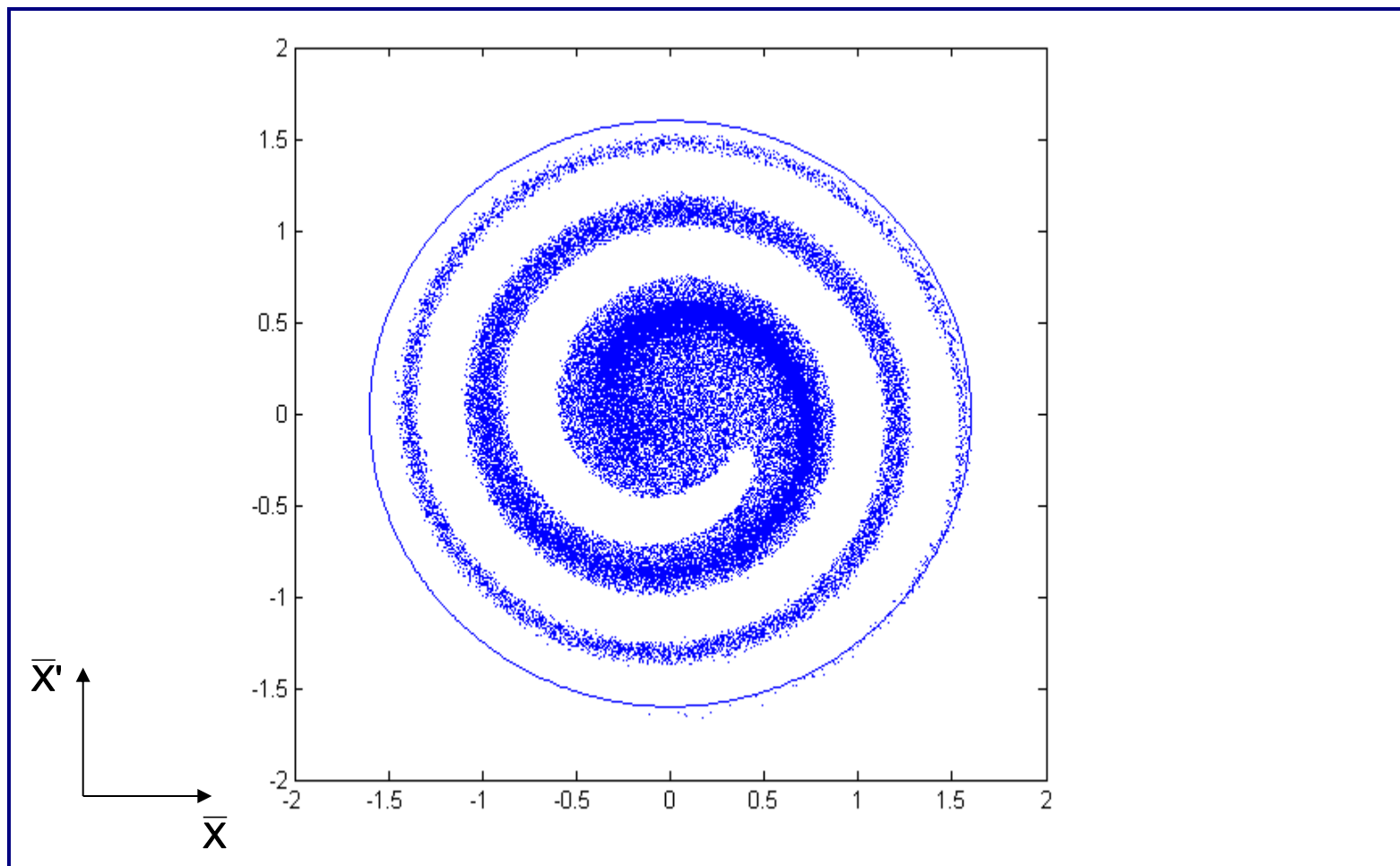

Filamentation

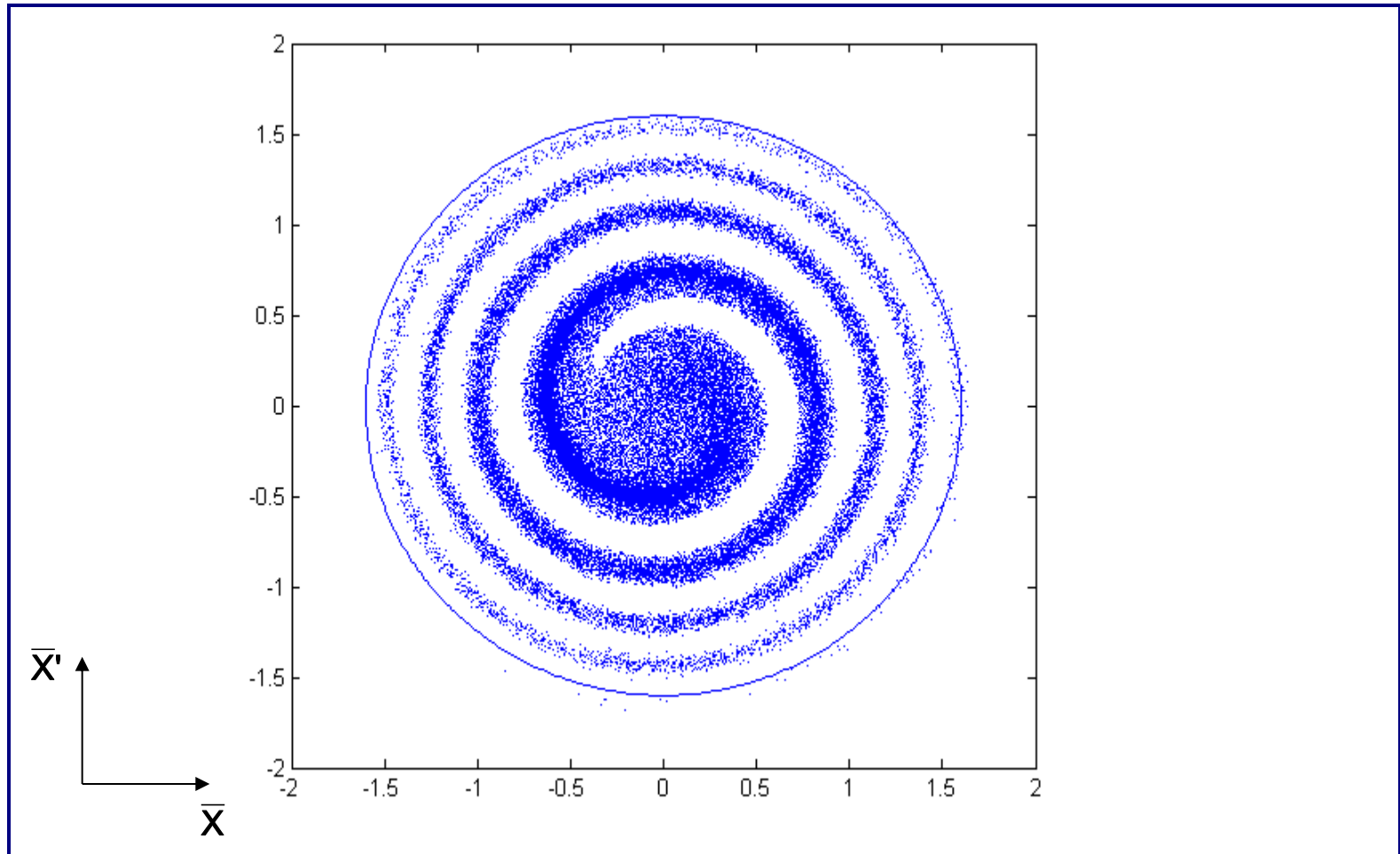

Filamentation

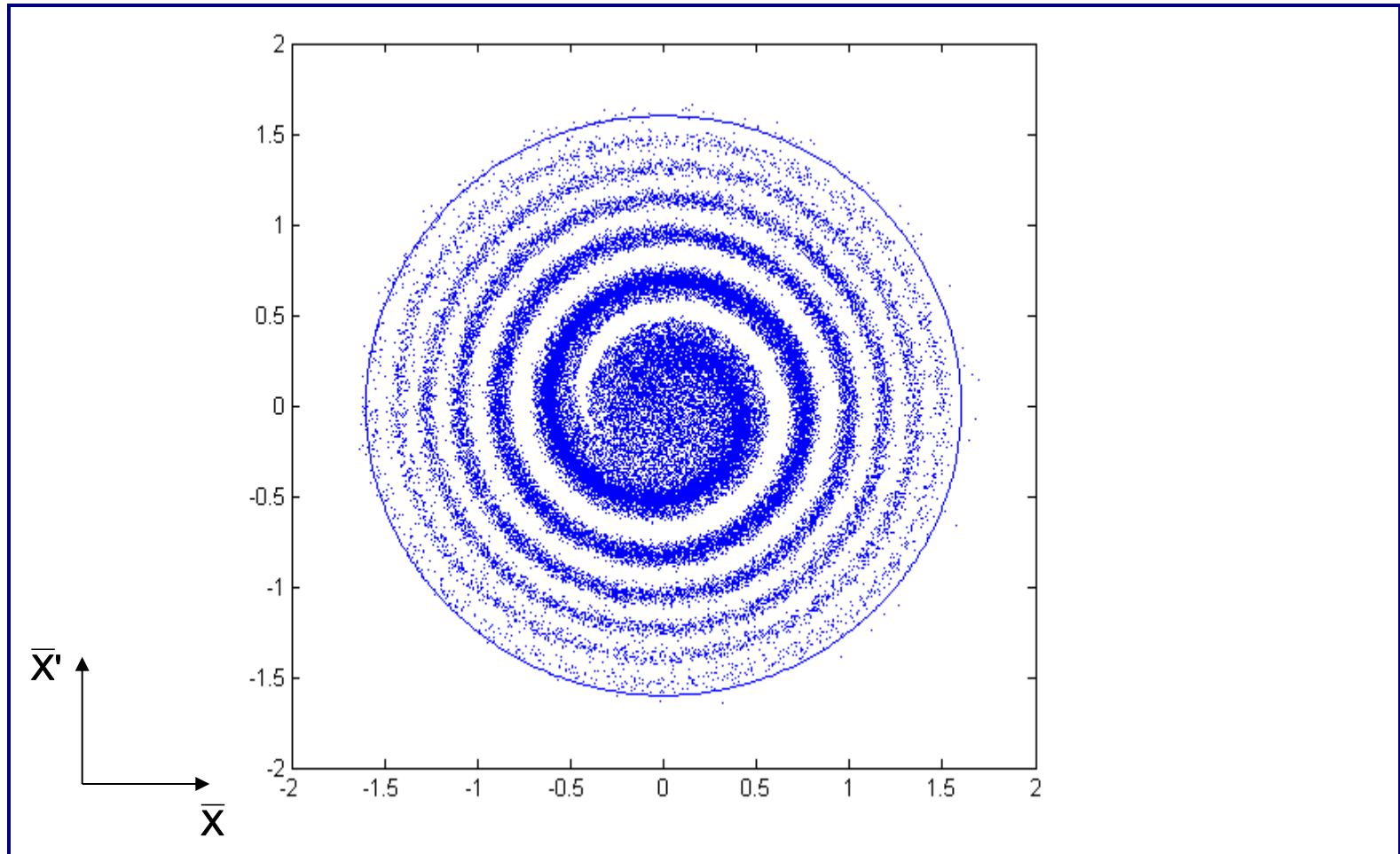

Filamentation

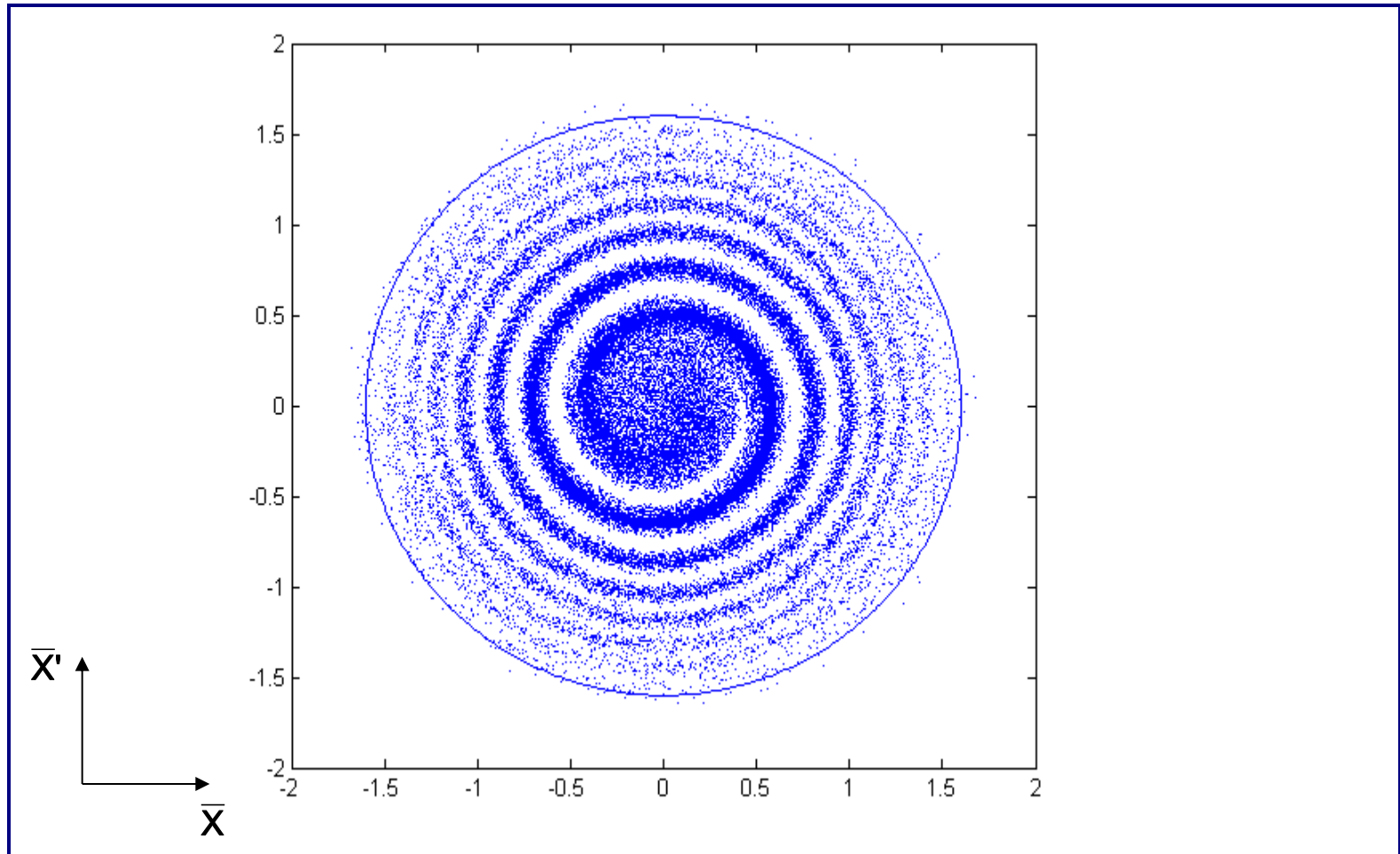

Filamentation

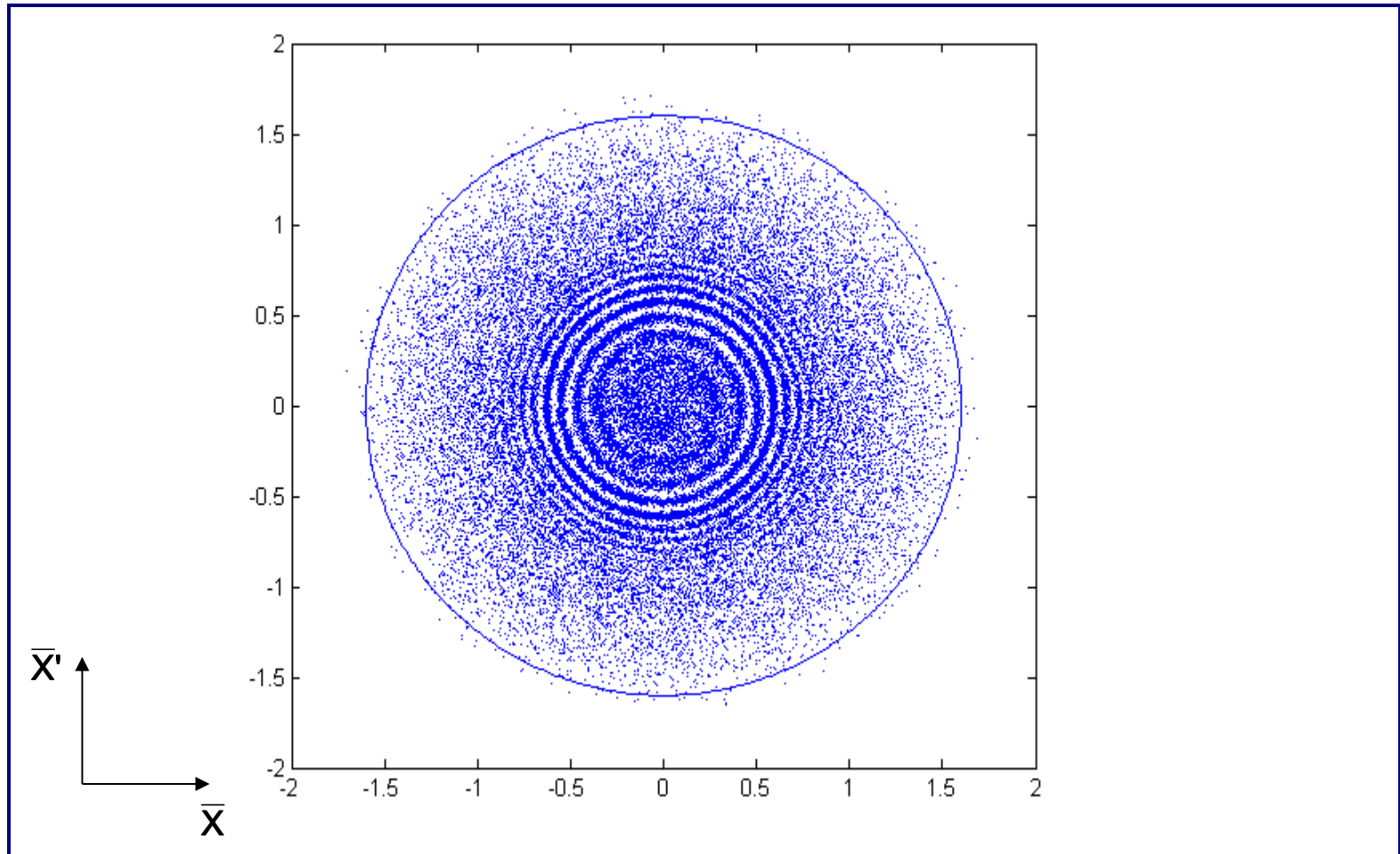

Filamentation

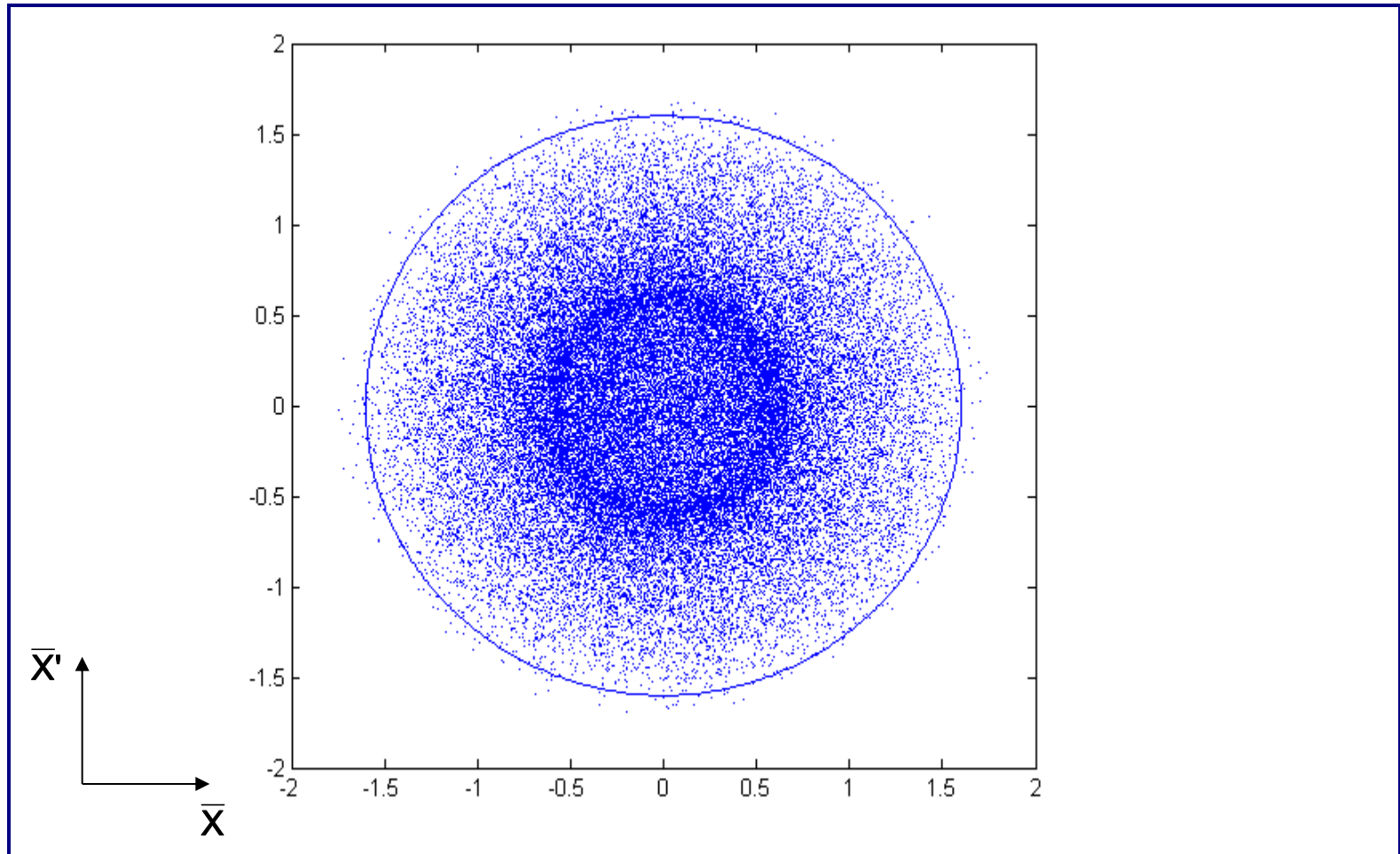

Damping of injection oscillations

- Residual transverse oscillations lead to an emittance blow-up through filamentation
- “Transverse damper” systems used to damp injection oscillations - bunch position measured by a pick-up, which is linked to a kicker
- Damper measures offset of bunch on one turn, then kicks the bunch on a subsequent turn to reduce the oscillation amplitude

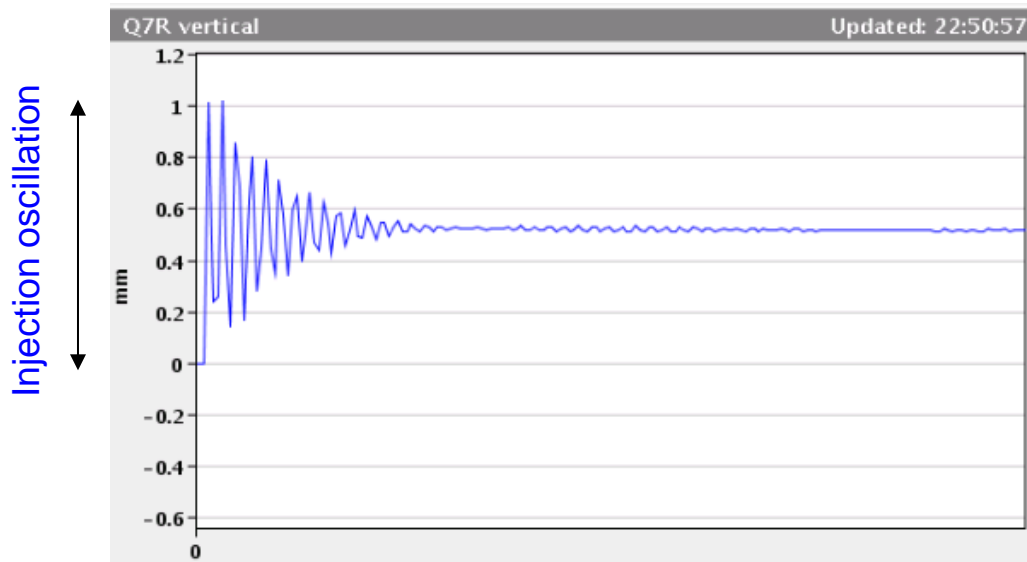

Optical Mismatch at Injection

- Can also have an emittance blow-up through optical mismatch
- Individual particles oscillate with conserved CS invariant:

$$a_x = \gamma x^2 + 2\alpha xx' + \beta x'^2$$

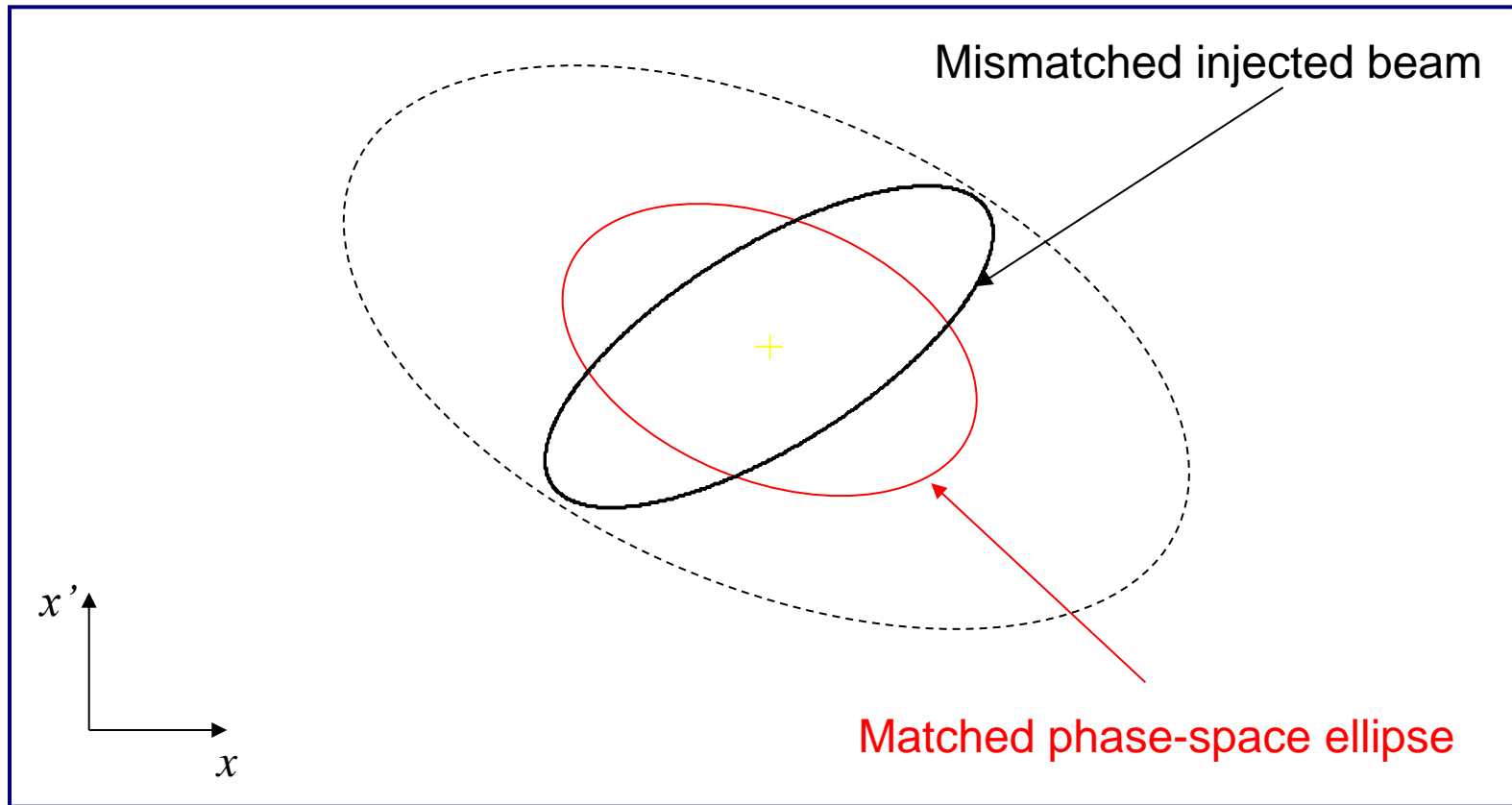

Optical Mismatch at Injection

- Filamentation fills larger ellipse with same shape as matched ellipse

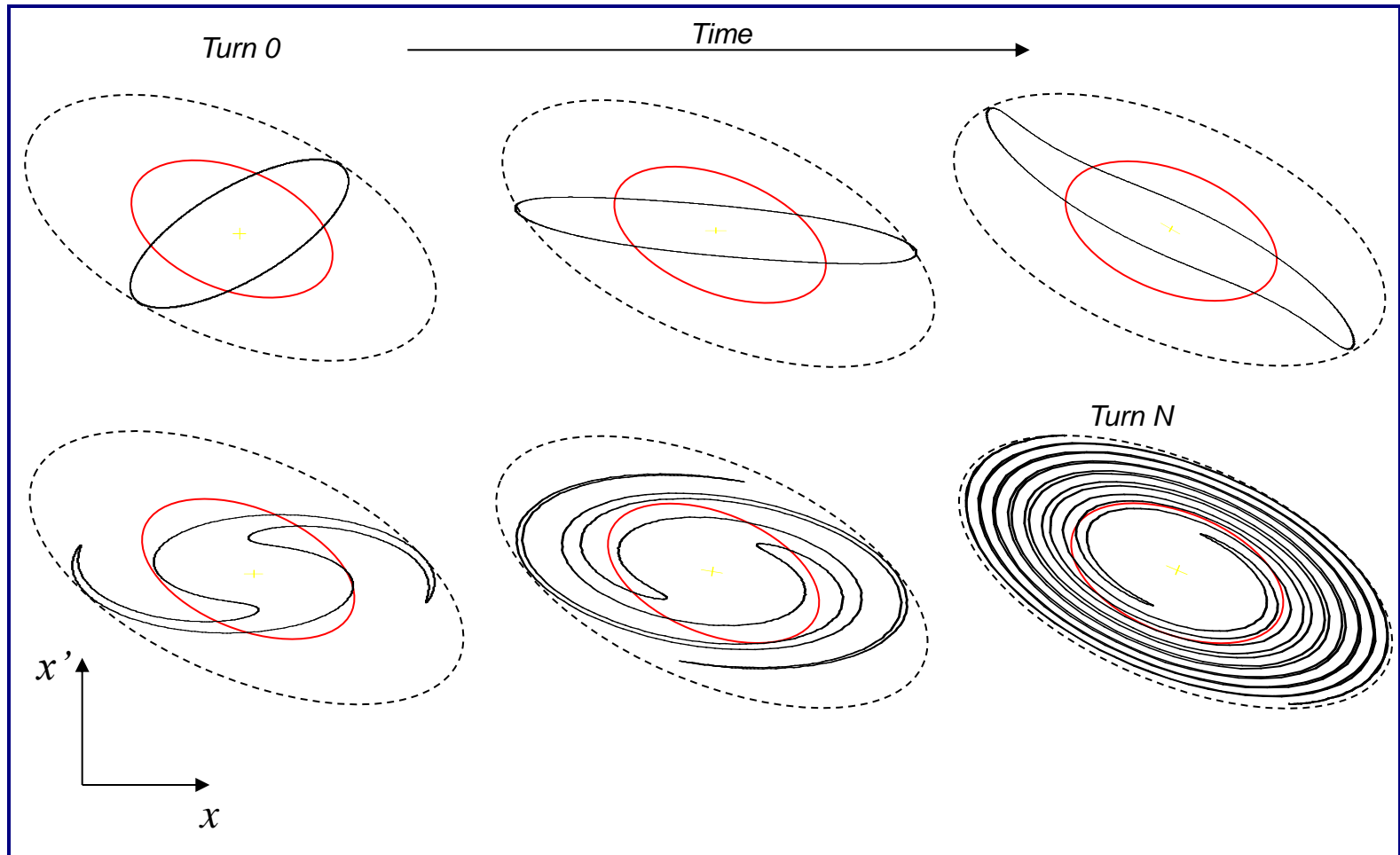

Multi-turn injection

- For hadrons the beam density at injection can be limited either by space charge effects or by the injector capacity
- If we cannot increase charge density, we can sometimes fill the horizontal phase space to increase overall injected intensity.
 - Condition that the acceptance of receiving machine is larger than the delivered beam emittance

Multi-turn injection for hadrons

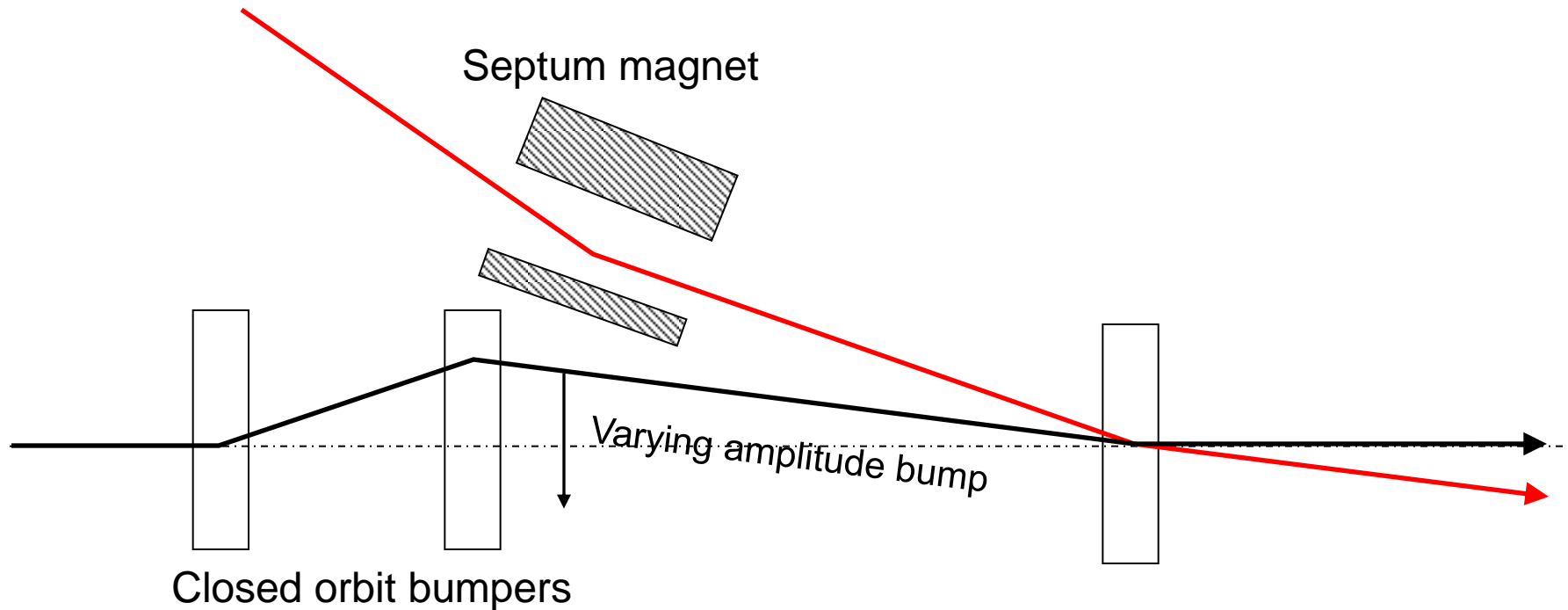

- No kicker
- Bump amplitude decreases and inject a new bunch at each turn
- Phase-space “painting”

Multi-turn injection for hadrons

Example: CERN PSB injection, fractional tune $Q_h = 0.25$
Beam rotates $\pi/2$ per turn in phase space

Turn 1

On each turn inject a
new batch and reduce
the bump amplitude

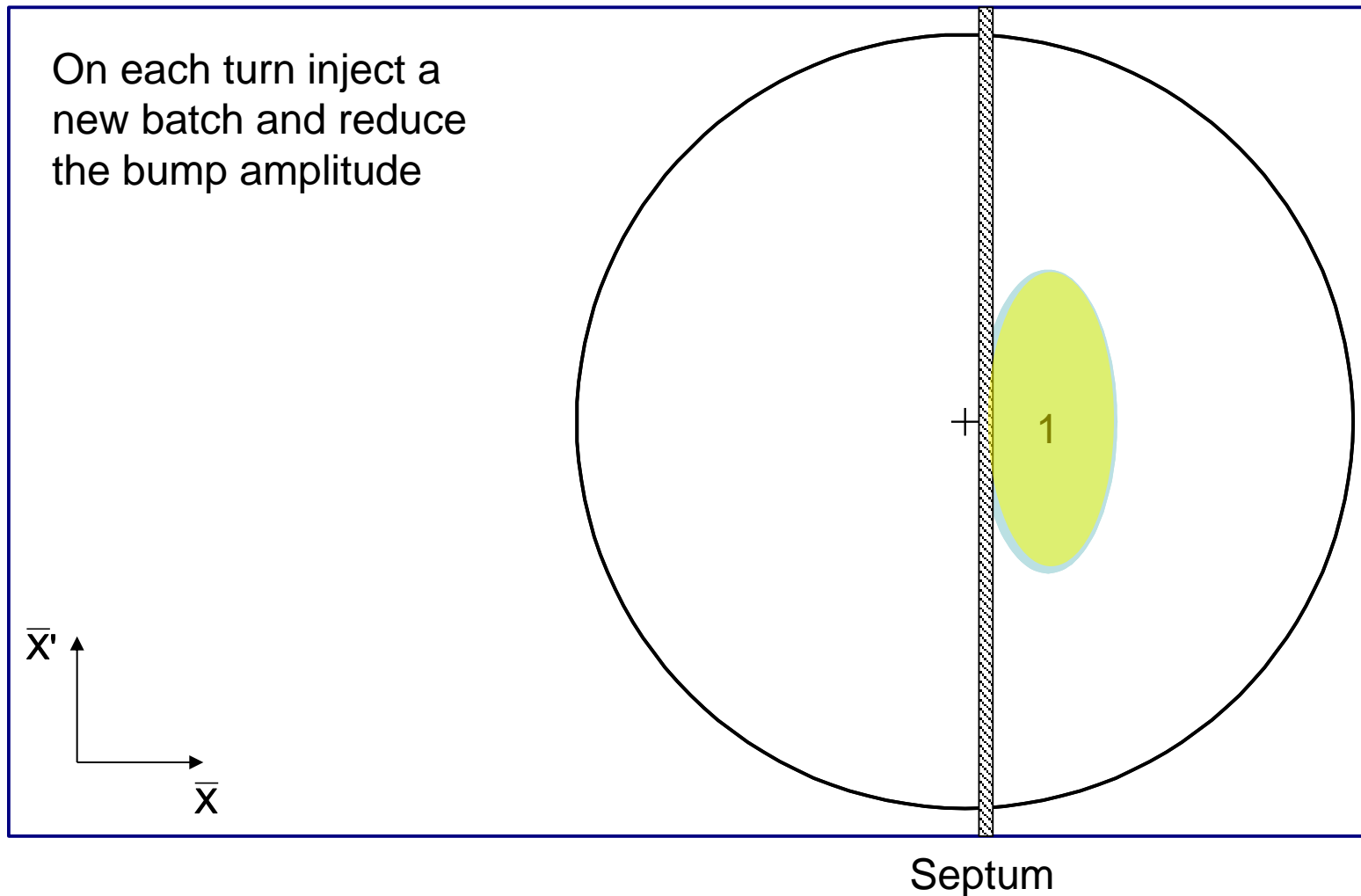

Multi-turn injection for hadrons

Turn 2

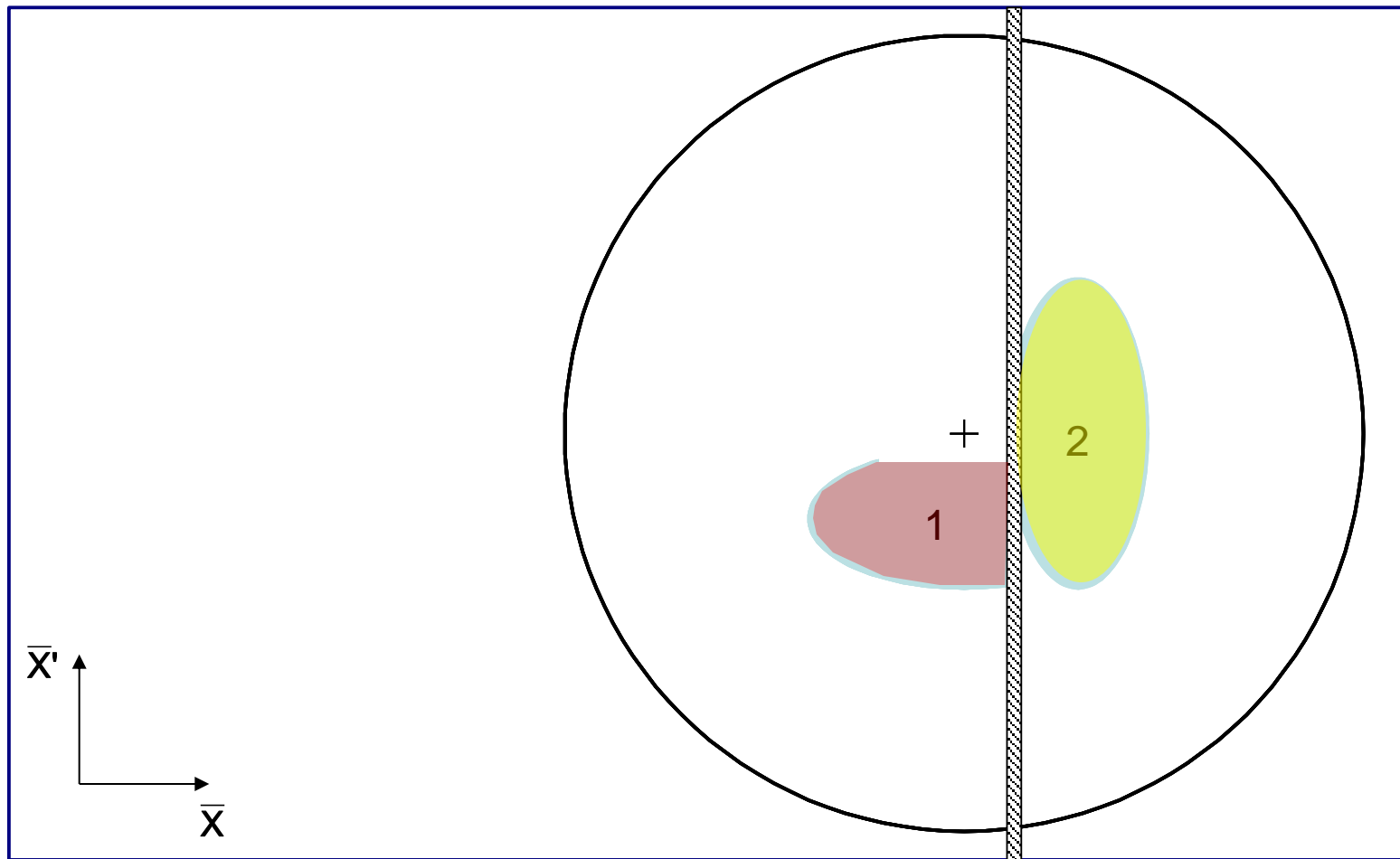

Multi-turn injection for hadrons

Turn 3

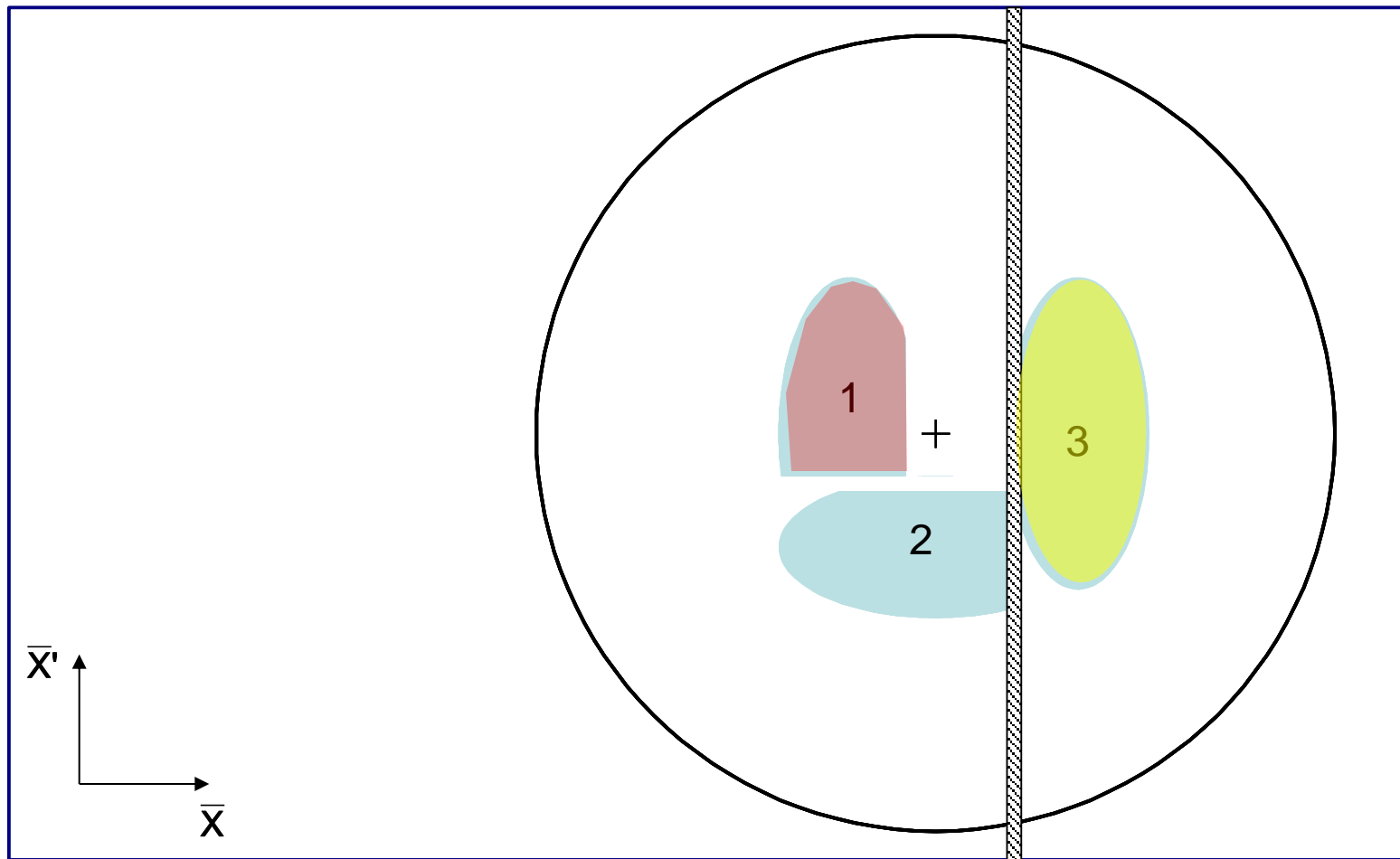

Multi-turn injection for hadrons

Turn 4

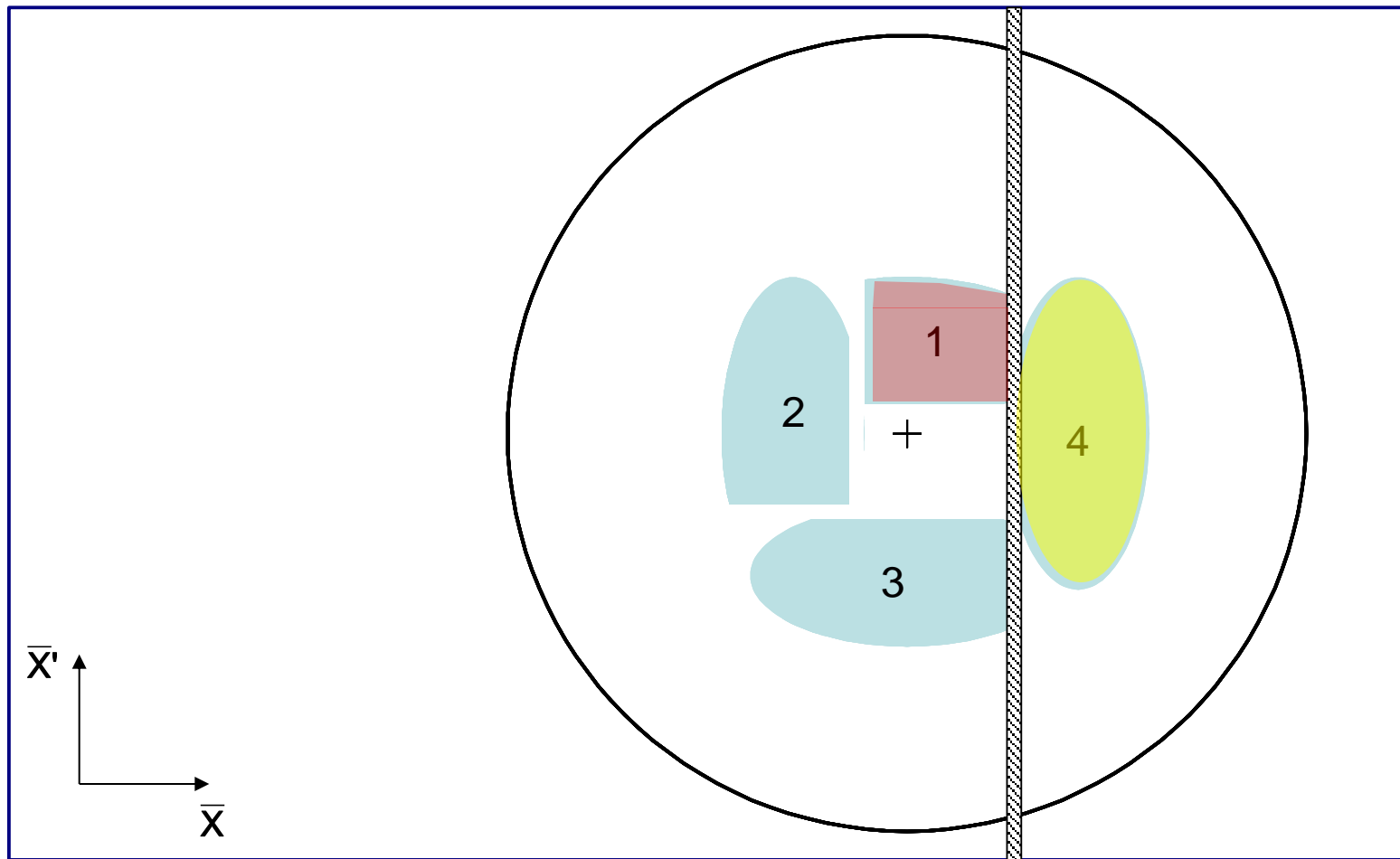

Multi-turn injection for hadrons

Turn 5

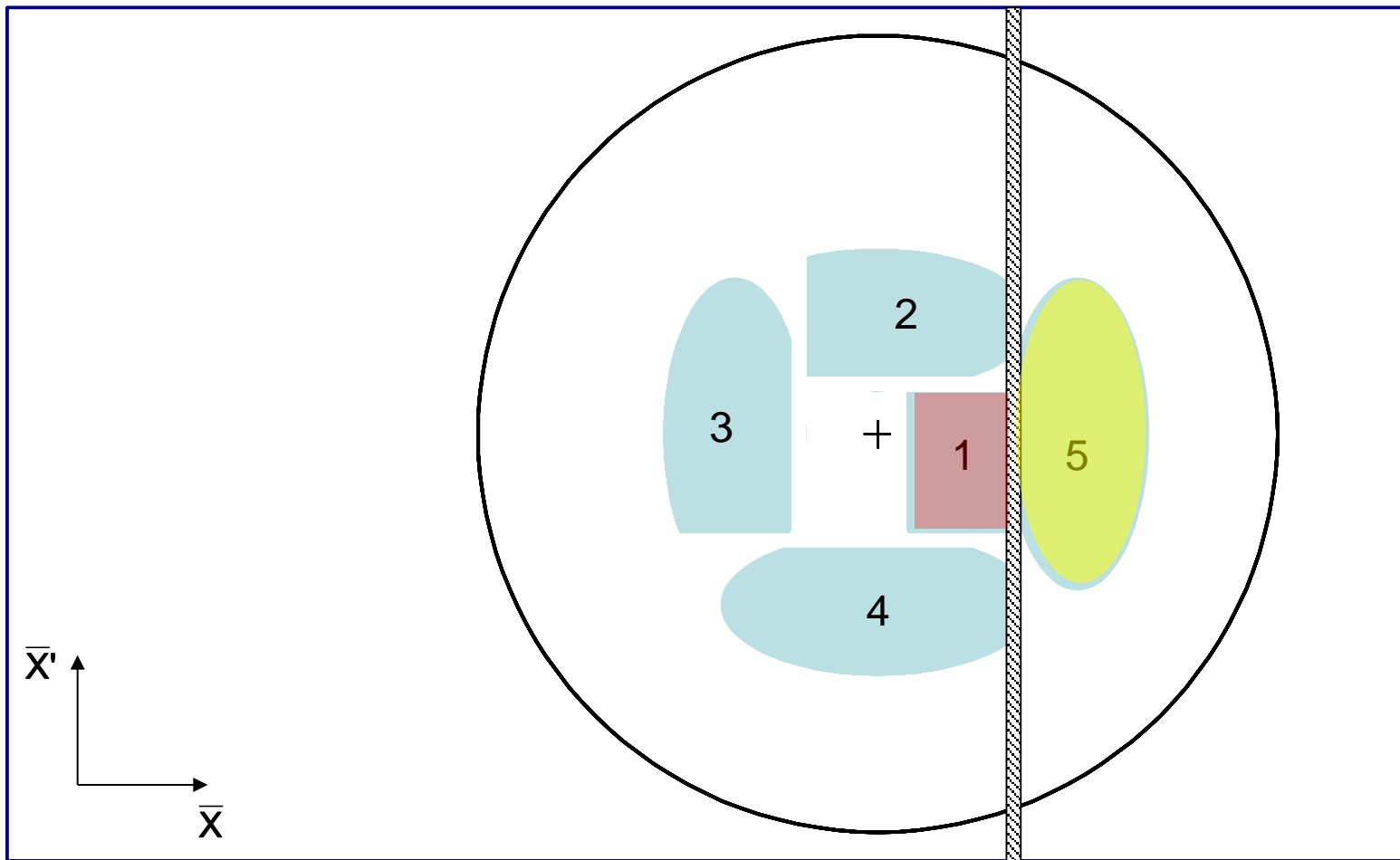

Multi-turn injection for hadrons

Turn 6

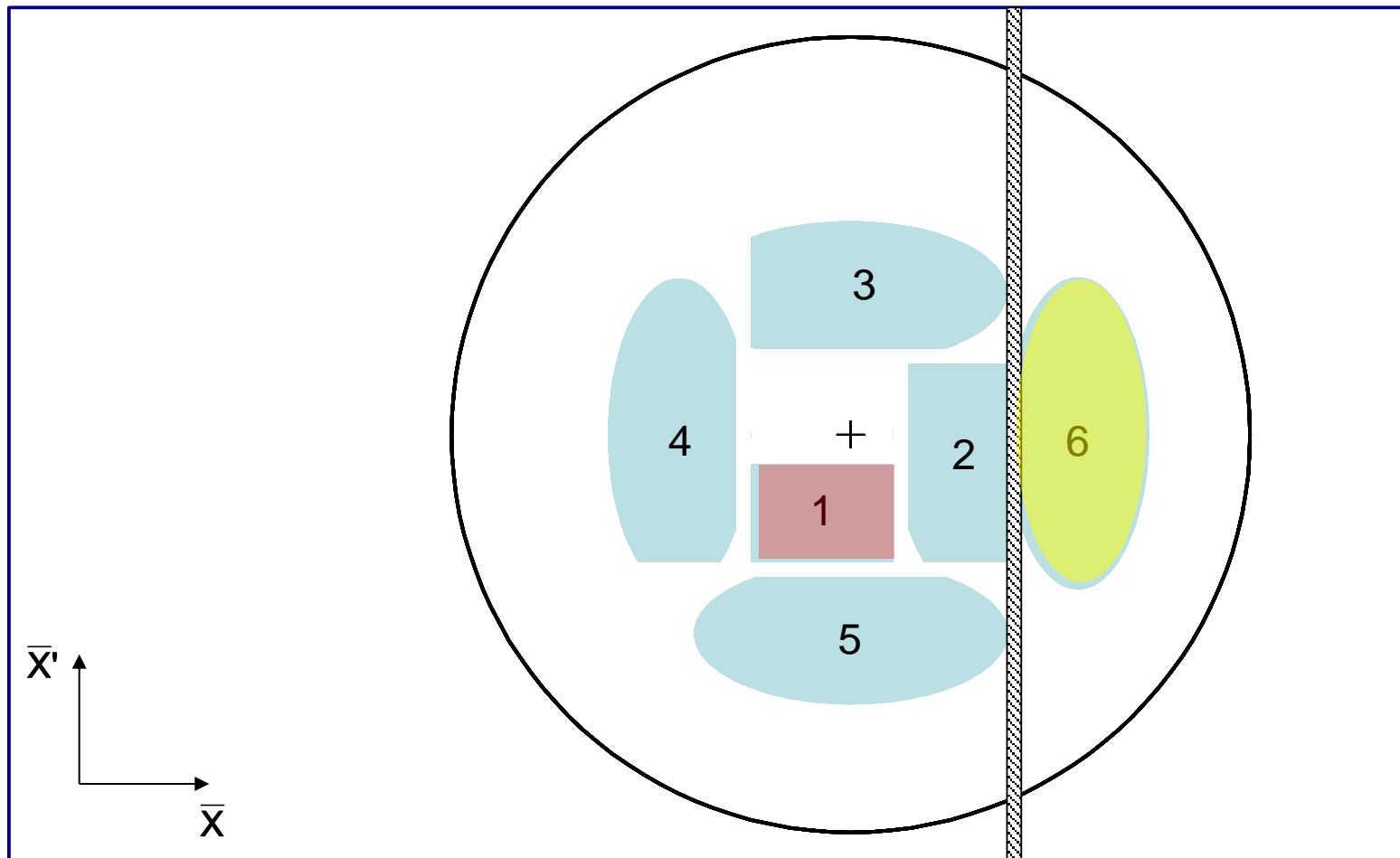

Multi-turn injection for hadrons

Turn 7

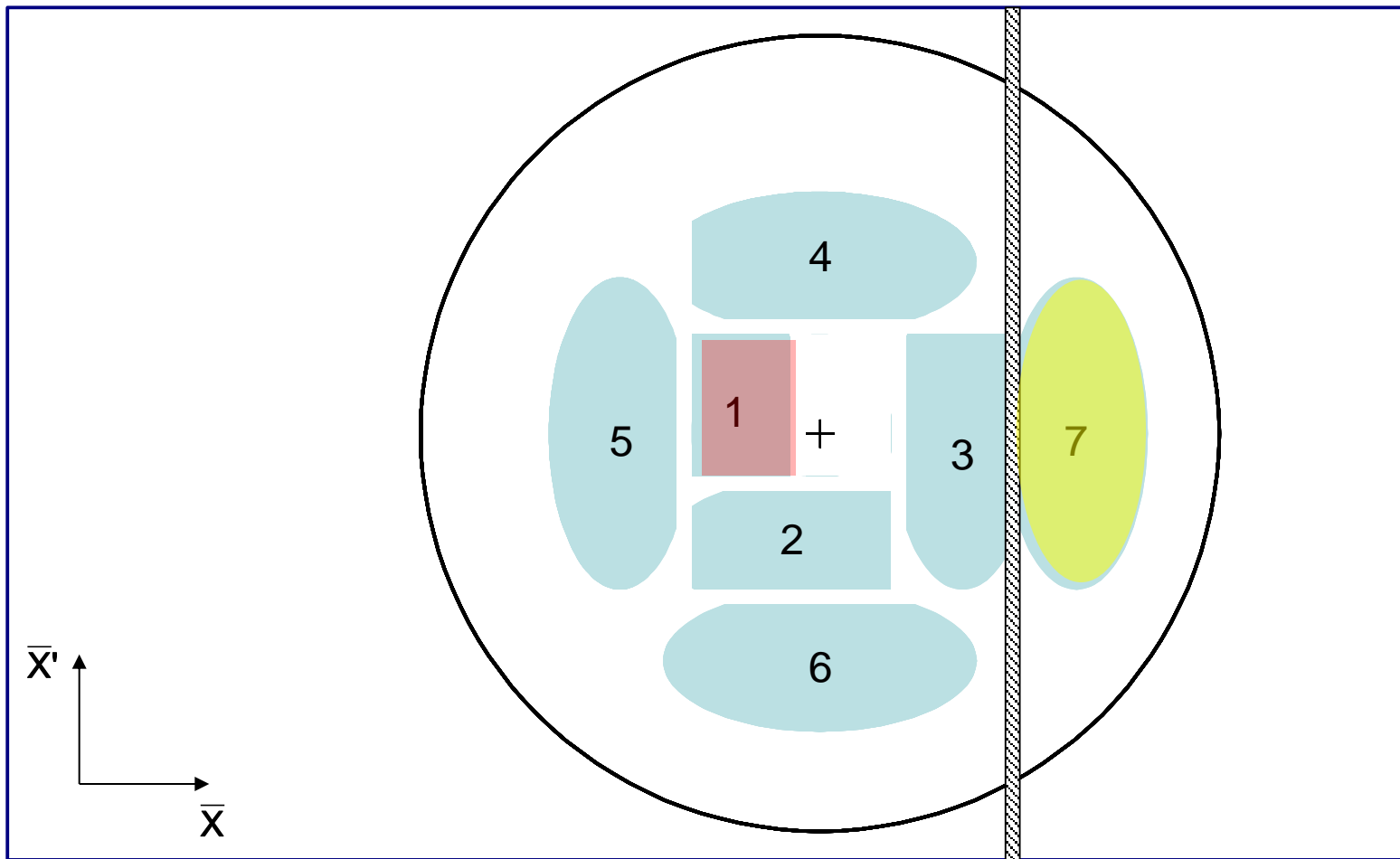

Multi-turn injection for hadrons

Turn 8

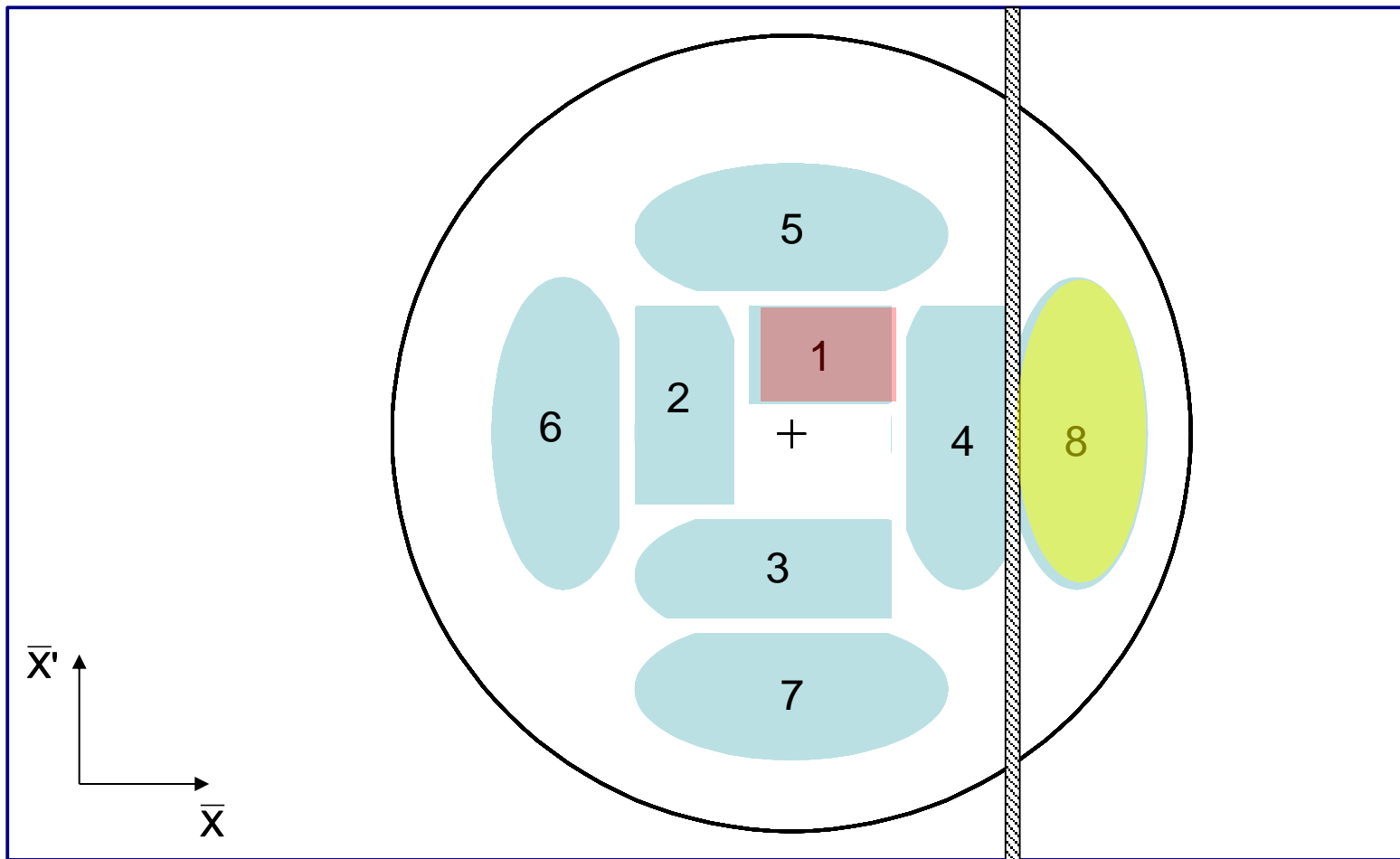

Multi-turn injection for hadrons

Turn 9

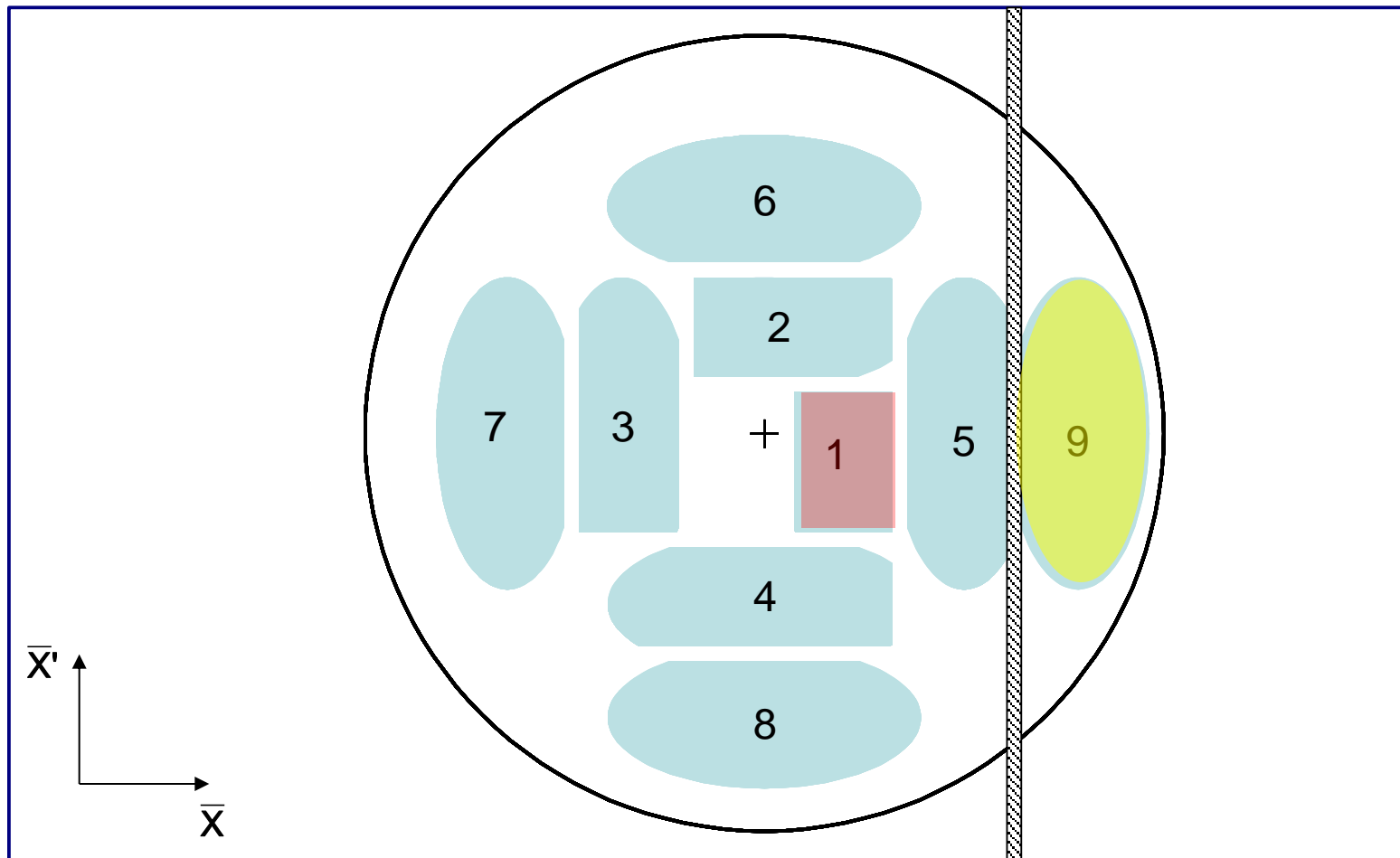

Multi-turn injection for hadrons

Turn 10

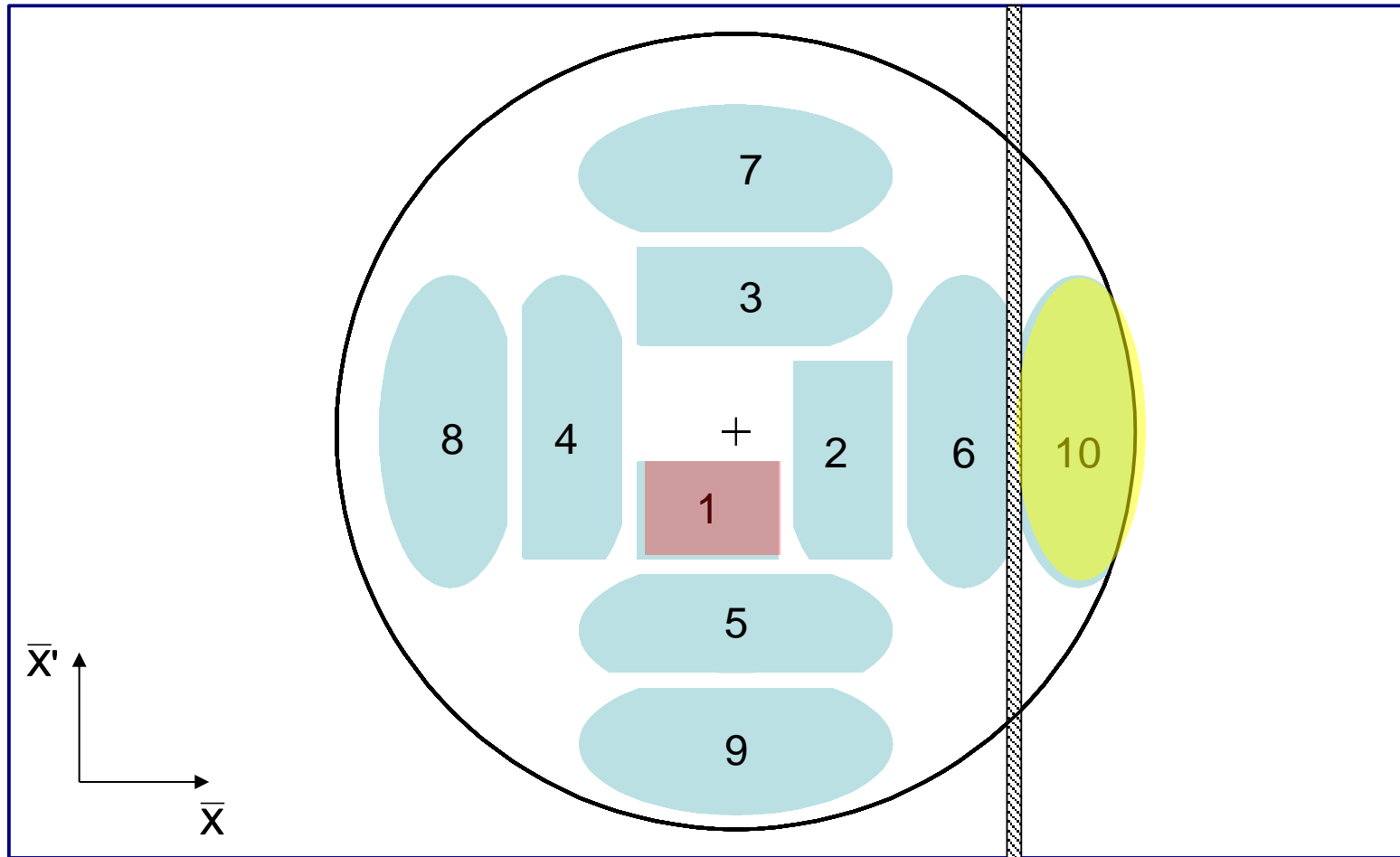

Multi-turn injection for hadrons

Turn 11

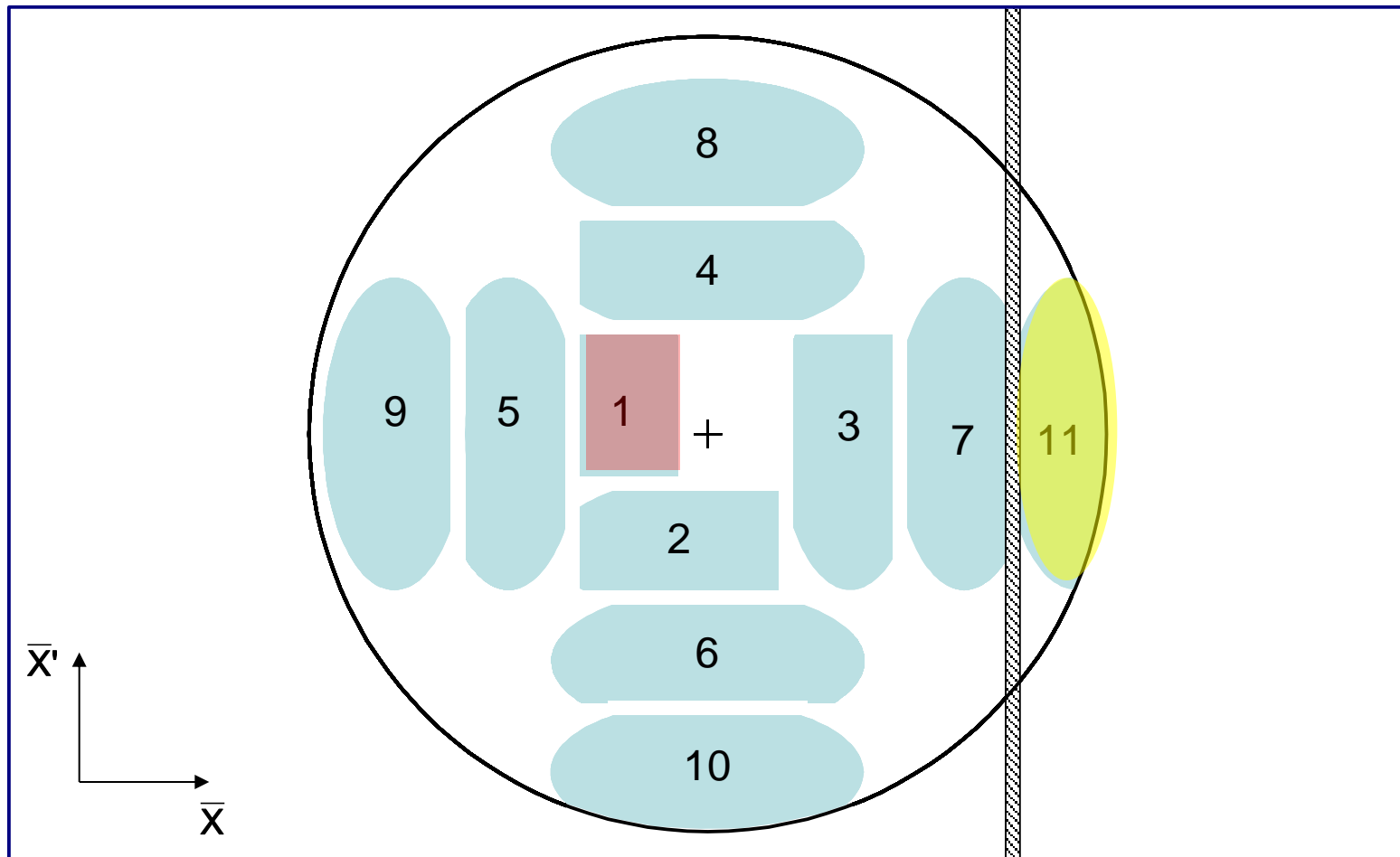

Multi-turn injection for hadrons

Turn 12

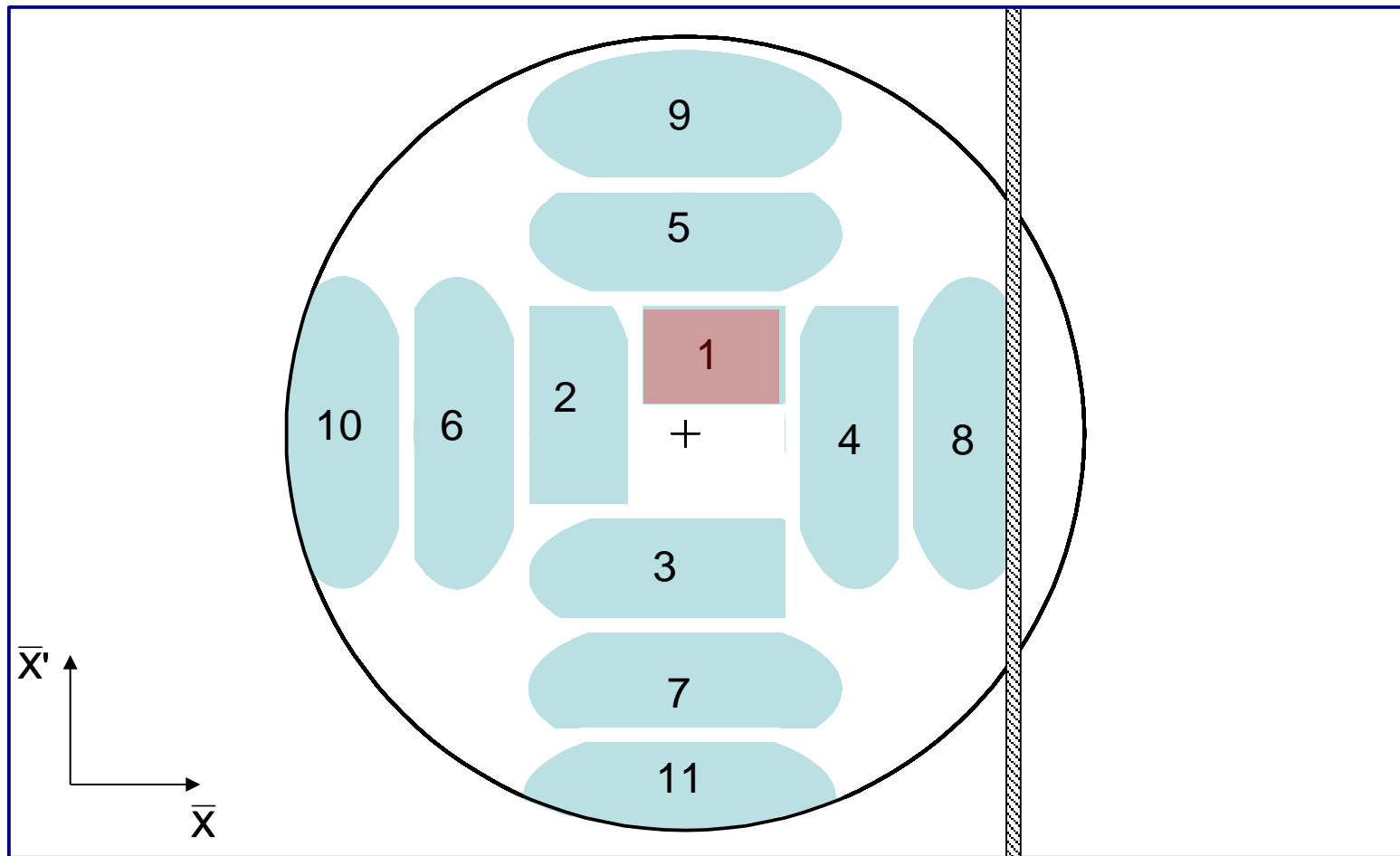

Multi-turn injection for hadrons

Turn 13

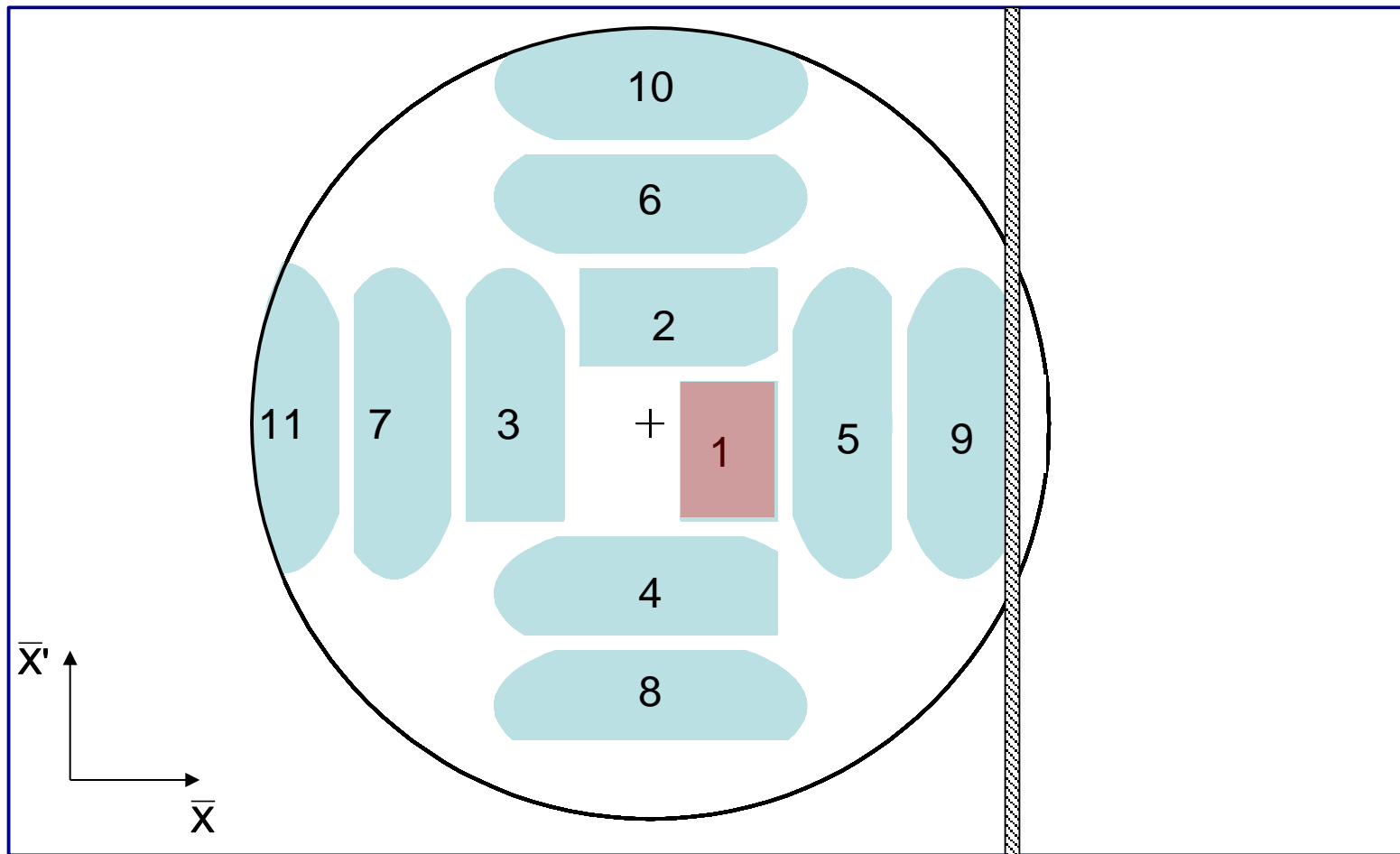

Multi-turn injection for hadrons

Turn 14

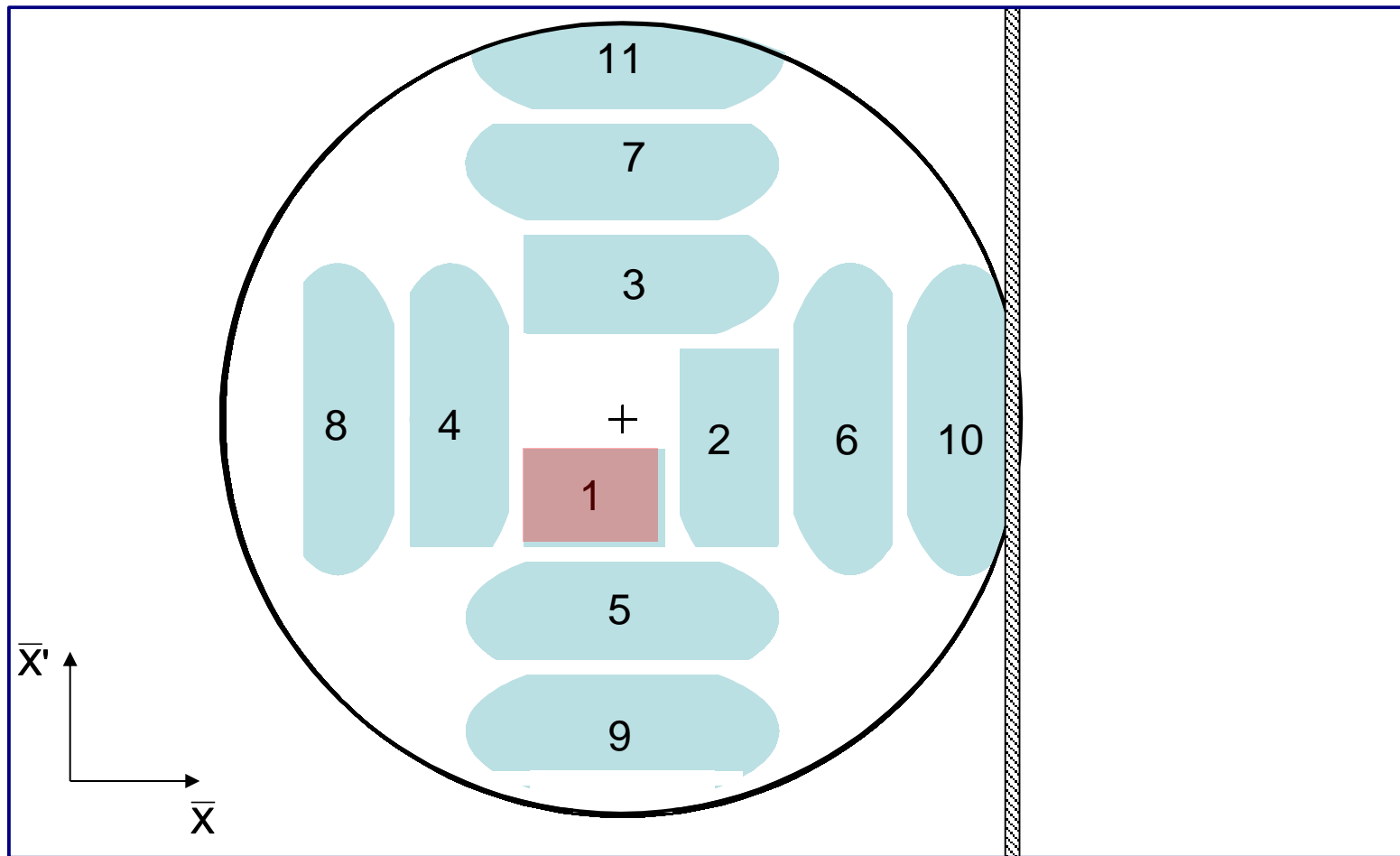

Multi-turn injection for hadrons

Phase space has been “painted”

Turn 15

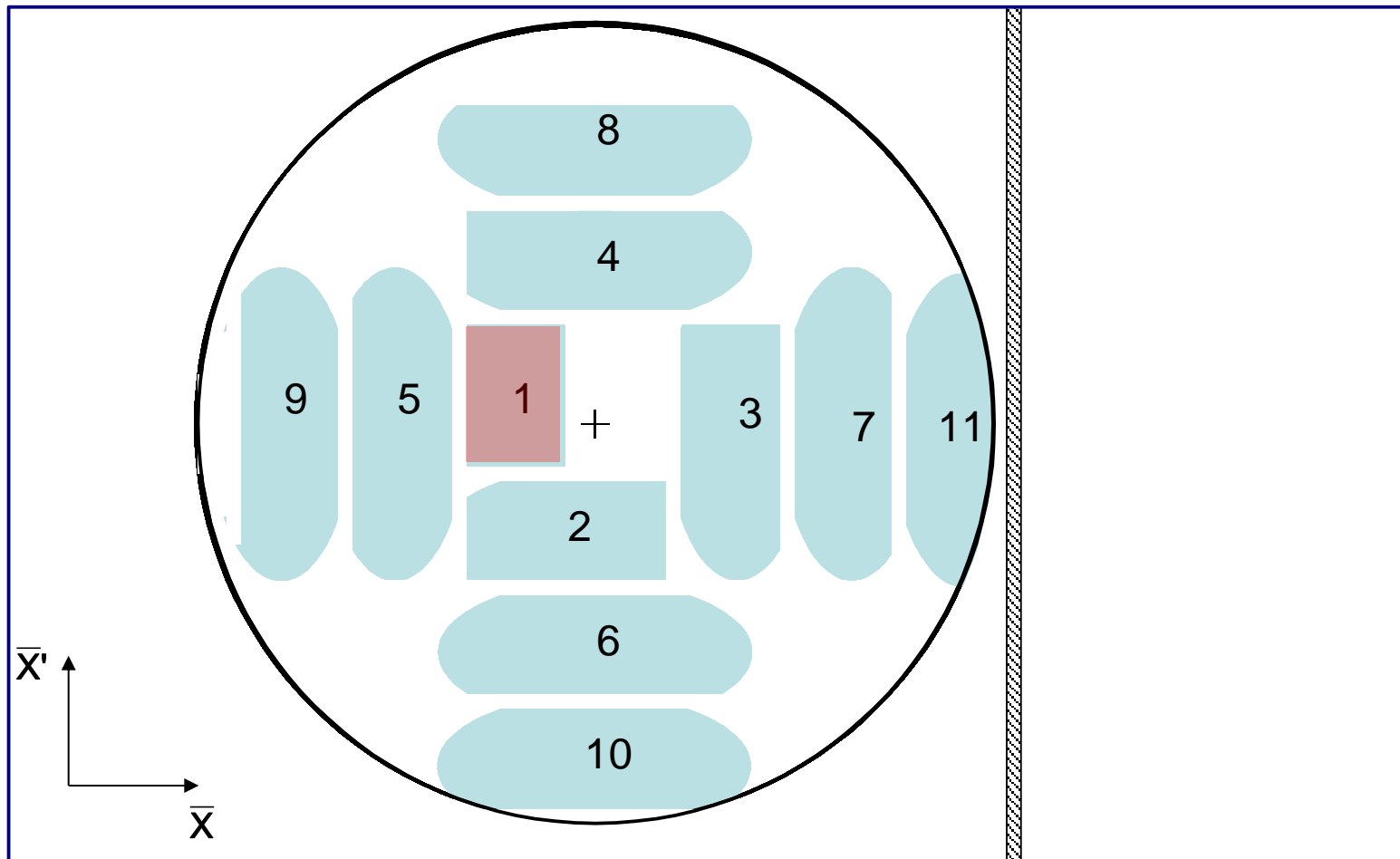

In reality filamentation occurs to produce a quasi-uniform beam

Injection mismatch

For multiturn injection over n turns, injected beam ellipse is deliberately mismatched to circulating beam ellipse to reduce losses

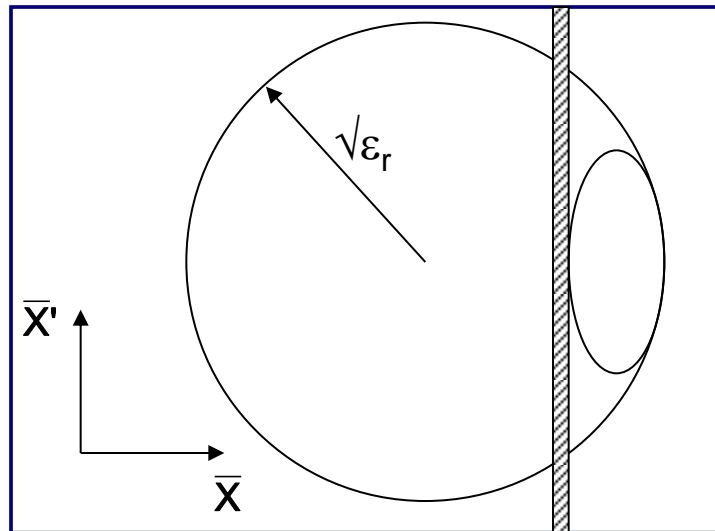

Charge exchange H⁻ injection

- Multiturn injection is essential to accumulate high intensity
- Disadvantages inherent in using an injection septum
 - Width of several mm reduces aperture
 - Beam losses from circulating beam hitting septum
 - Limits number of injected turns to 10-20
- Charge-exchange injection provides elegant alternative
 - Possible to fully “deploy” Liouville’s theorem, which says that emittance is conserved....
 - Convert H⁻ to p⁺ using a thin stripping foil, allowing injection into the same phase space area

Charge exchange H- injection

Start of injection process

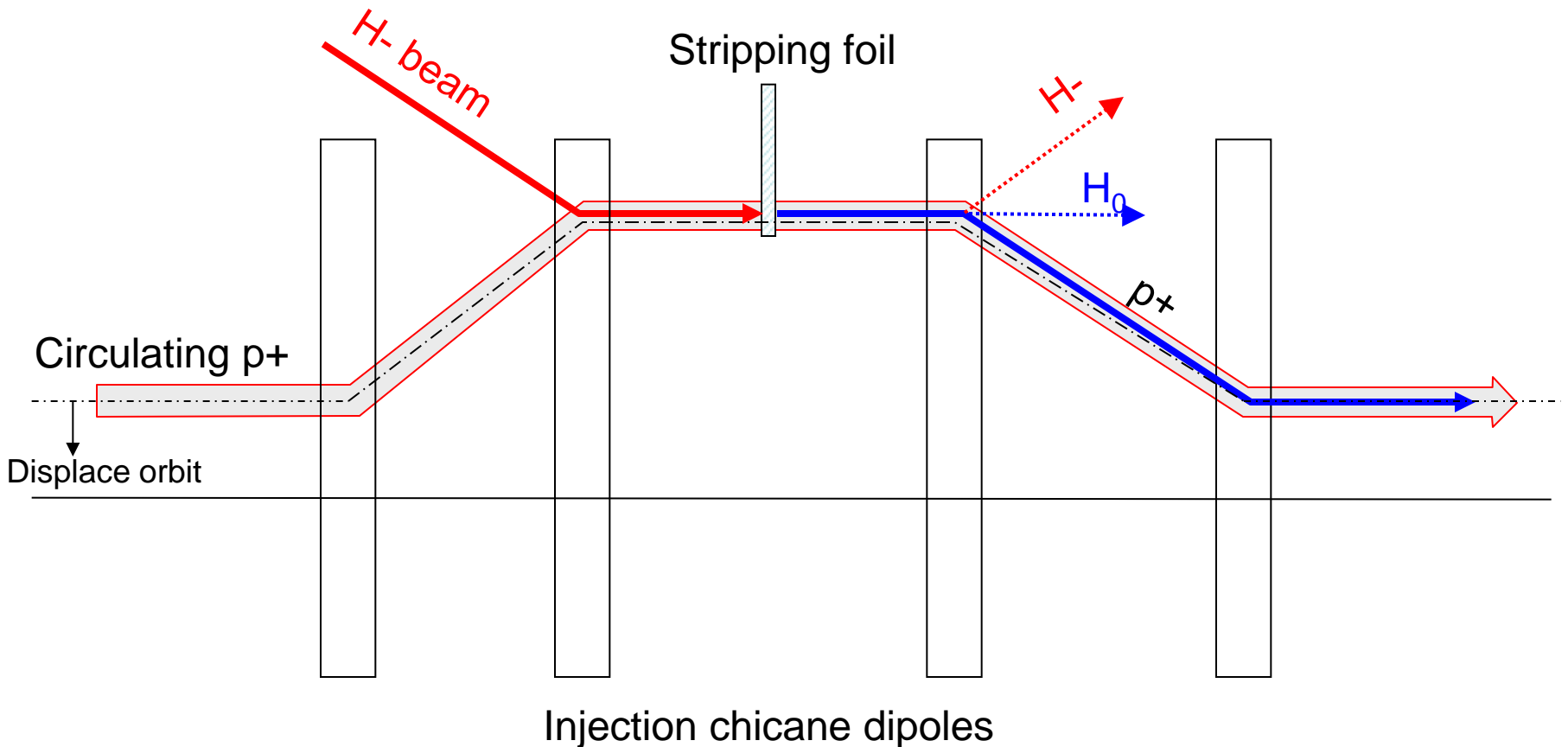

Charge exchange H- injection

End of injection process

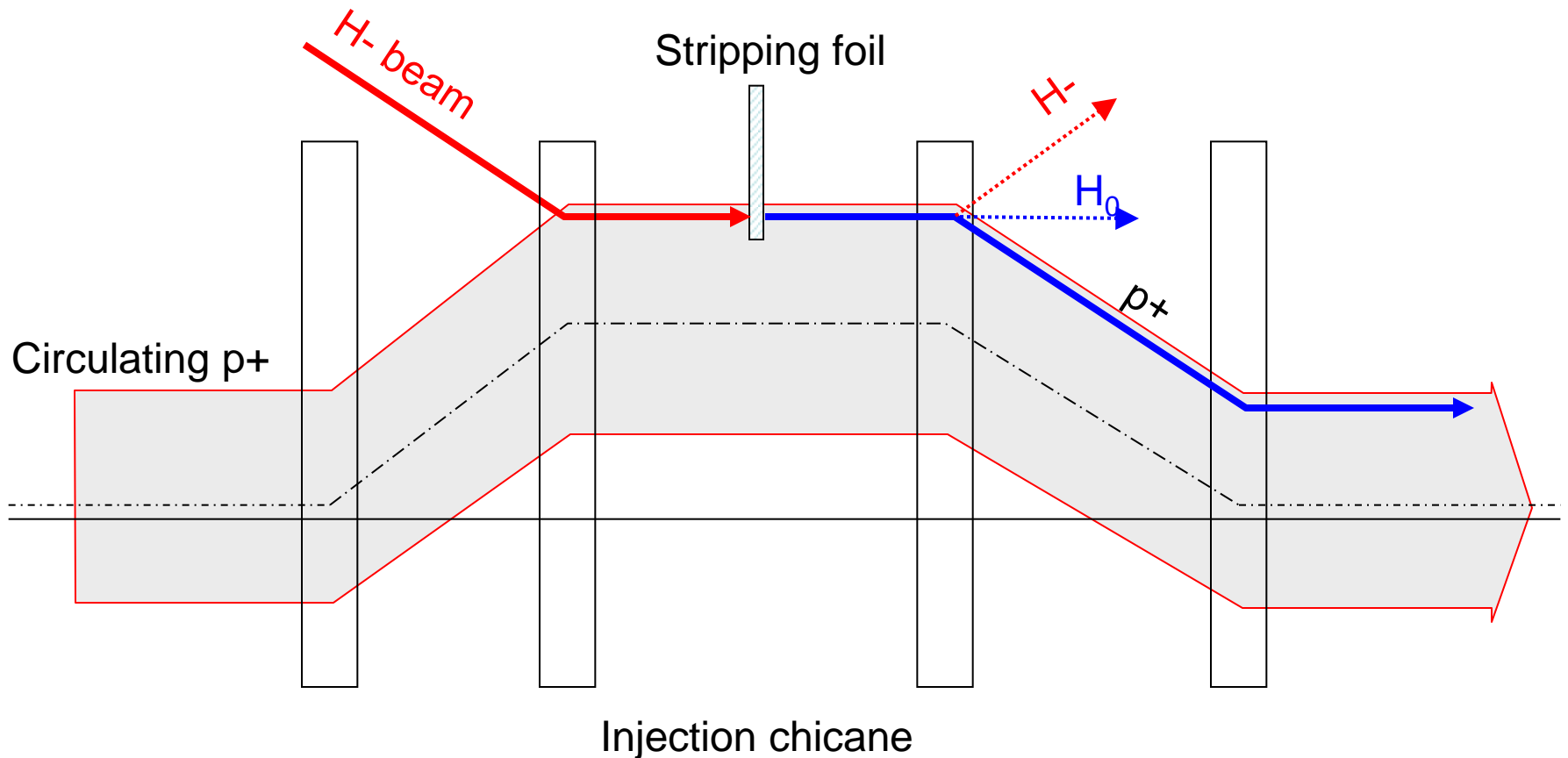

Charge exchange H- injection

- Paint uniform transverse phase space density by modifying closed orbit bump and steering injected beam
- Foil thickness calculated to double-strip most ions (>99%)
 - 50 MeV - 50 $\mu\text{g}\cdot\text{cm}^{-2}$
 - 800 MeV - 200 $\mu\text{g}\cdot\text{cm}^{-2}$ ($\sim 1\mu\text{m}$ of C!)
- Carbon foils generally used – very fragile
- Injection chicane reduced or switched off after injection, to avoid excessive foil heating and beam blow up

H- injection with laser stripping

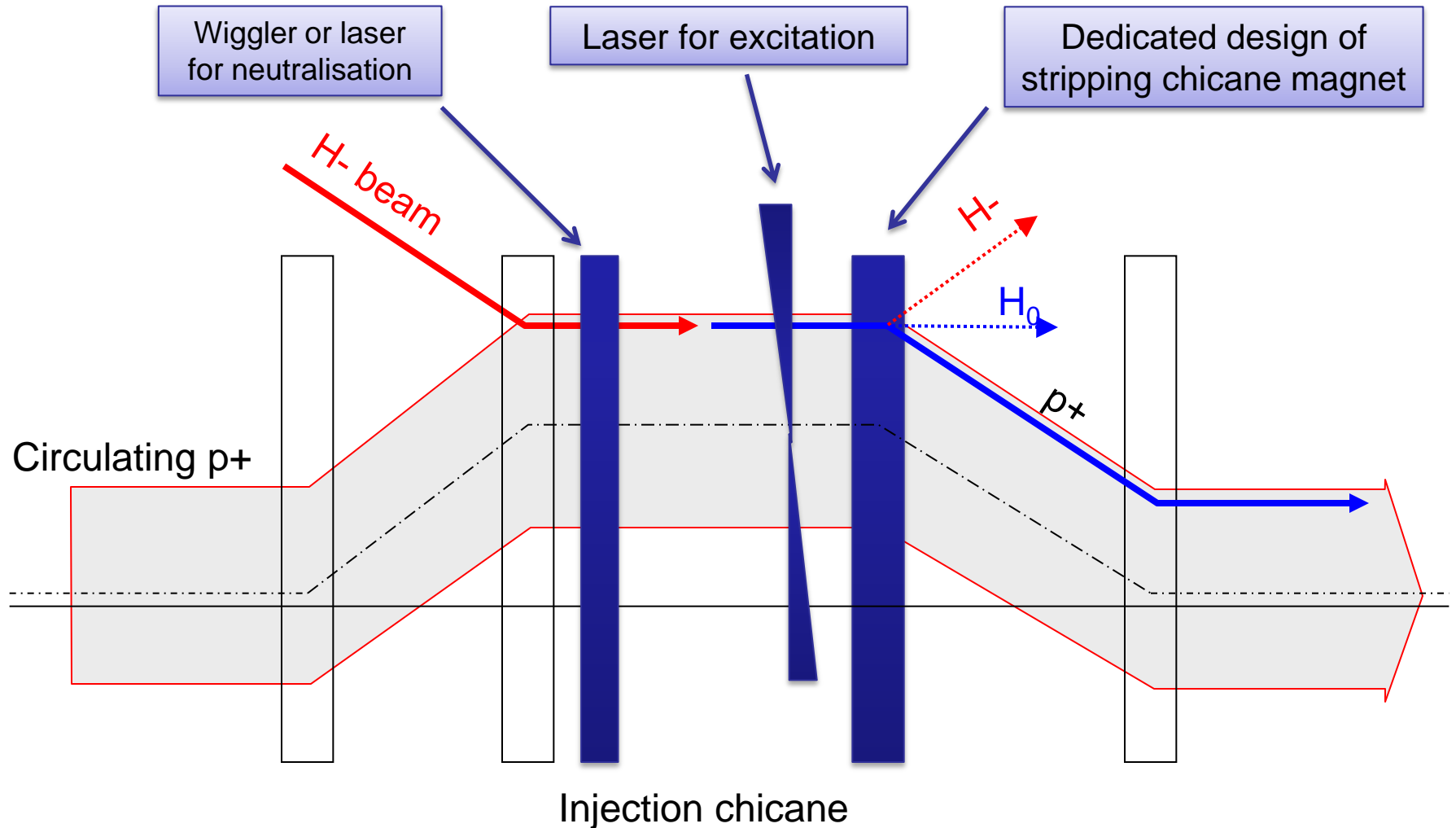

H- injection - painting

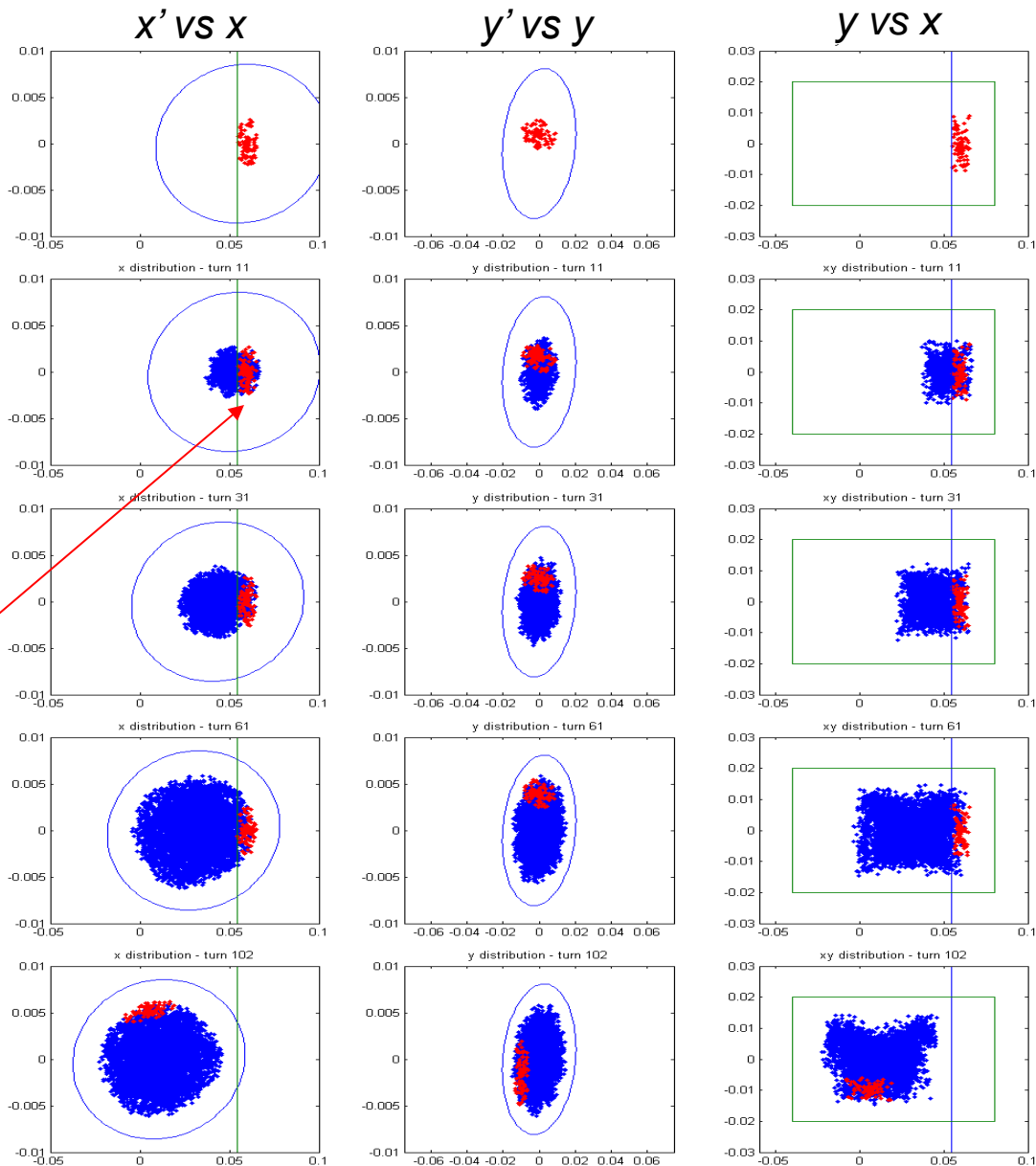

Note injection into same phase space area as circulating beam

Time

~100 turns

Lepton injection

- Single-turn injection can be used as for hadrons; however, lepton motion is strongly damped (different with respect to proton or ion injection).
 - Synchrotron radiation
- Can use transverse or longitudinal damping:
 - Transverse - Betatron accumulation
 - Longitudinal - Synchrotron accumulation

Betatron lepton injection

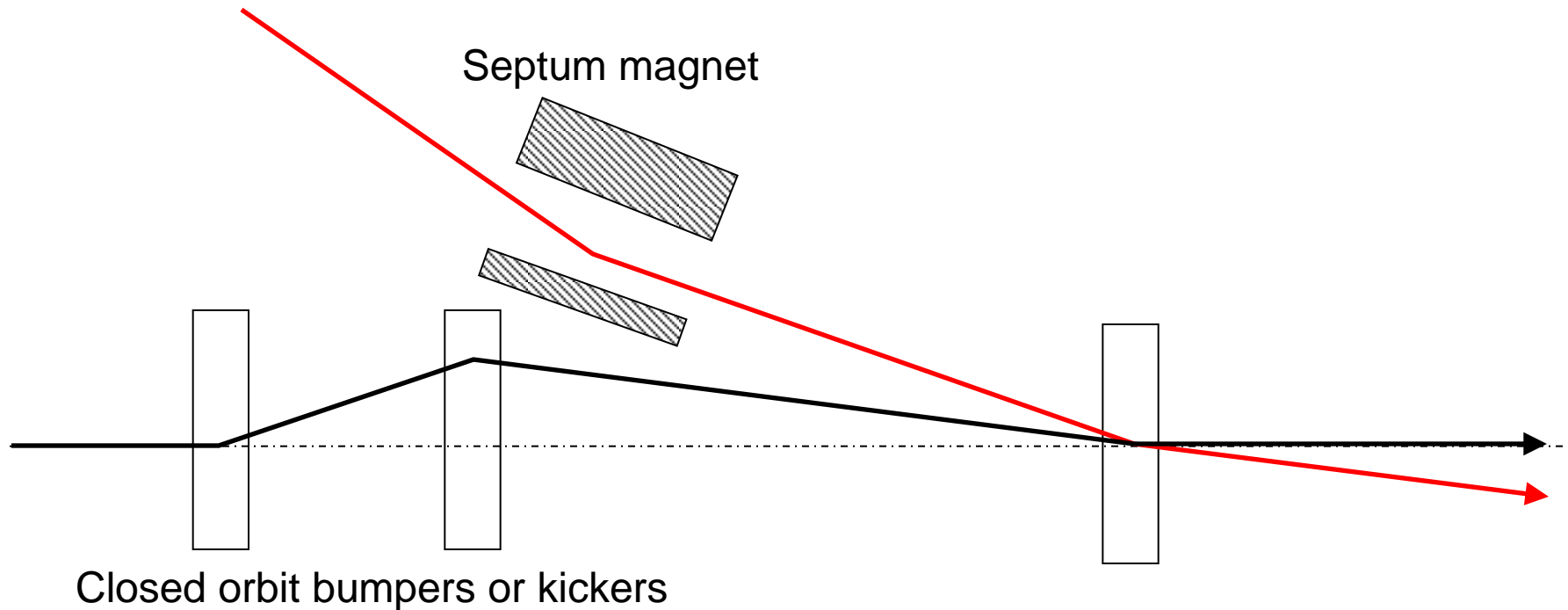

- Beam is injected with an angle with respect to the closed orbit
- Injected beam performs damped betatron oscillations about the closed orbit

Betatron lepton injection

Injected bunch performs damped betatron oscillations

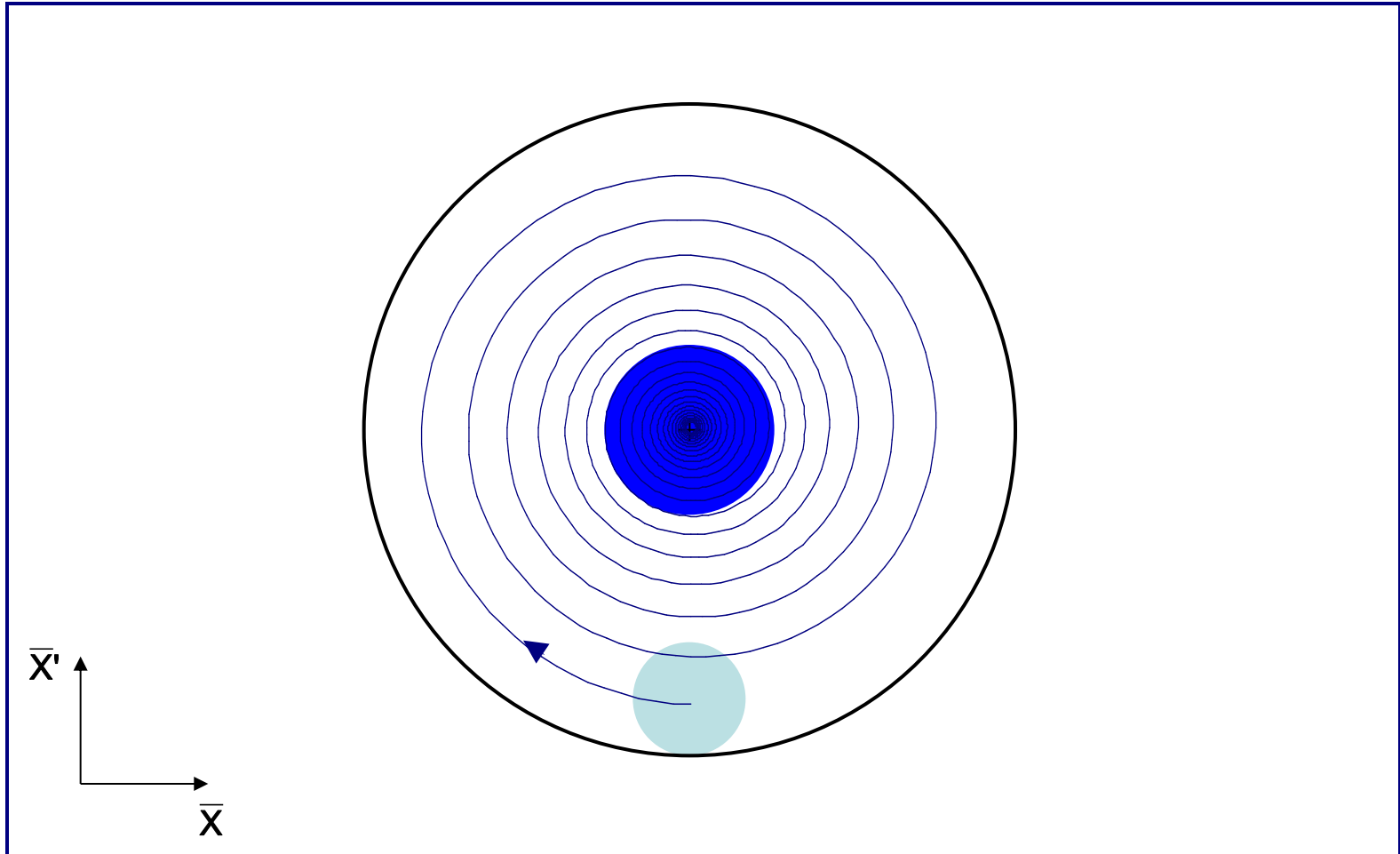

In LEP at 20 GeV, the damping time was about 6'000 turns (0.6 seconds)

Synchrotron lepton injection

Inject an off-momentum beam

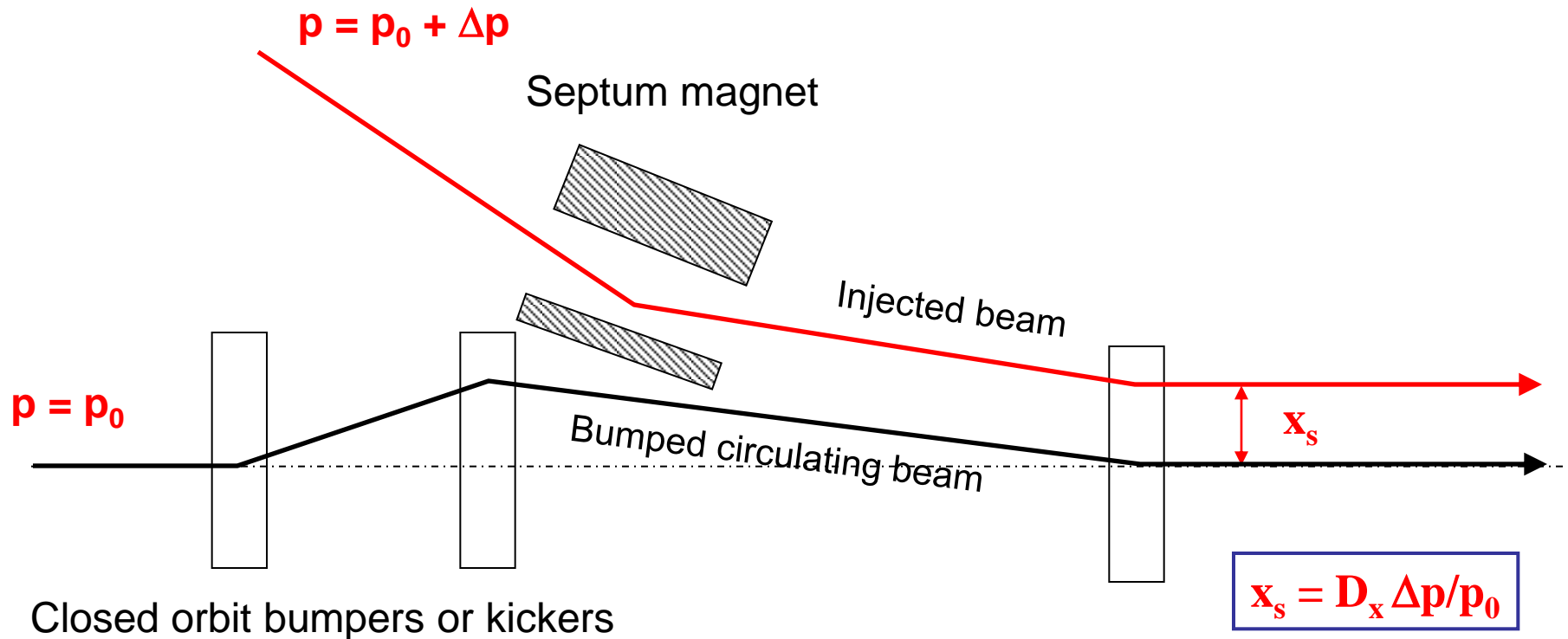

- Beam injected parallel to circulating beam, onto dispersion orbit of a particle having the same momentum offset $\Delta p/p$.
- Injected beam makes damped *synchrotron oscillations* at Q_s but does not perform betatron oscillations.

Synchrotron lepton injection

Double batch injection possible....

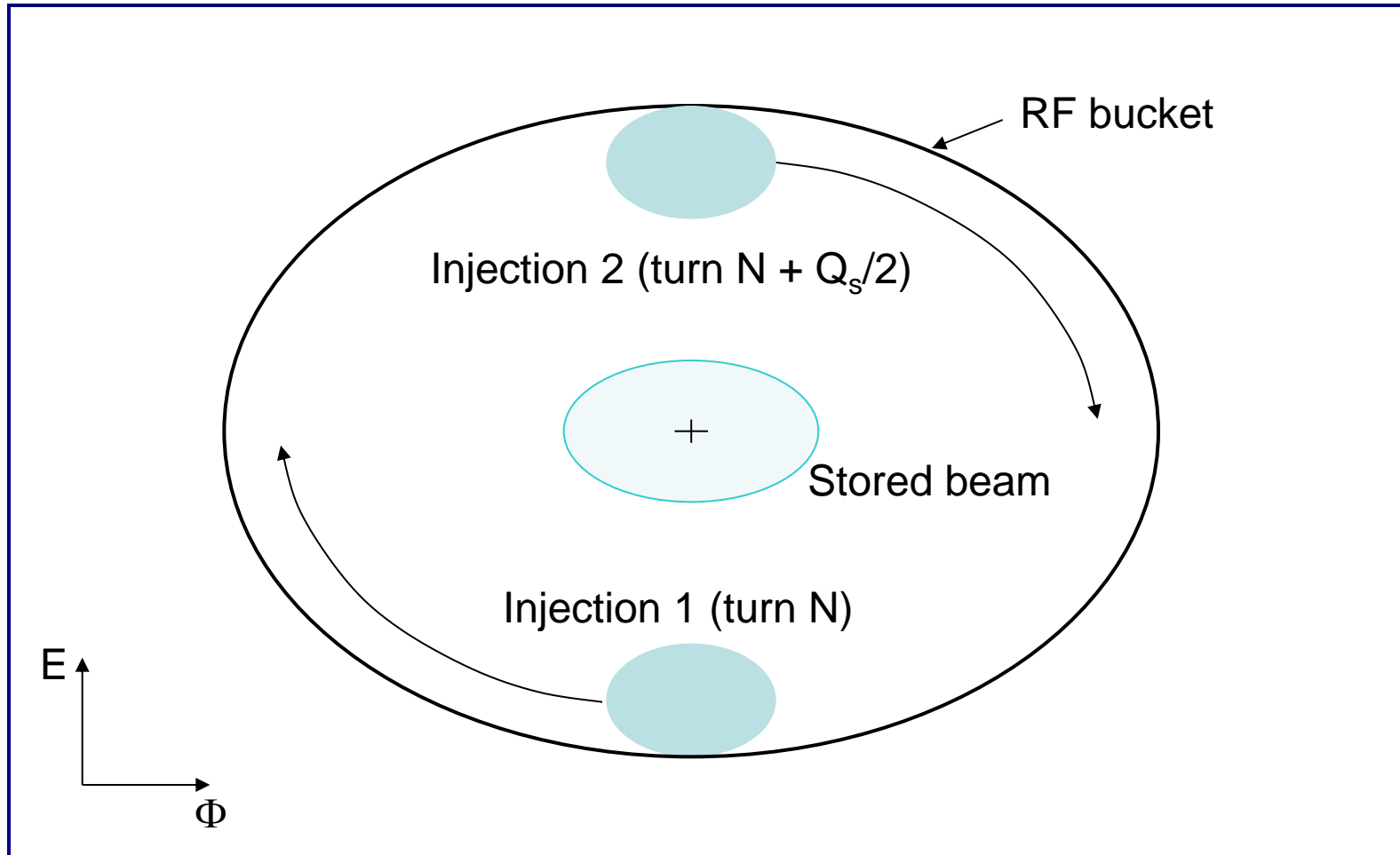

Longitudinal damping time in LEP was $\sim 3'000$ turns (2 x faster than transverse)

Synchrotron lepton injection in LEP

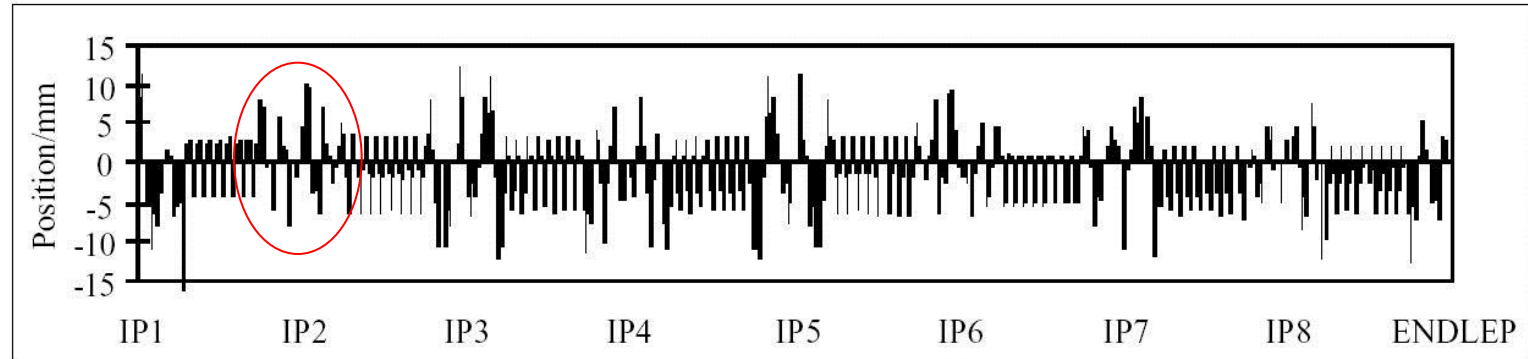

Optimized Horizontal First Turn Trajectory for Betatron Injection of Positrons into LEP.

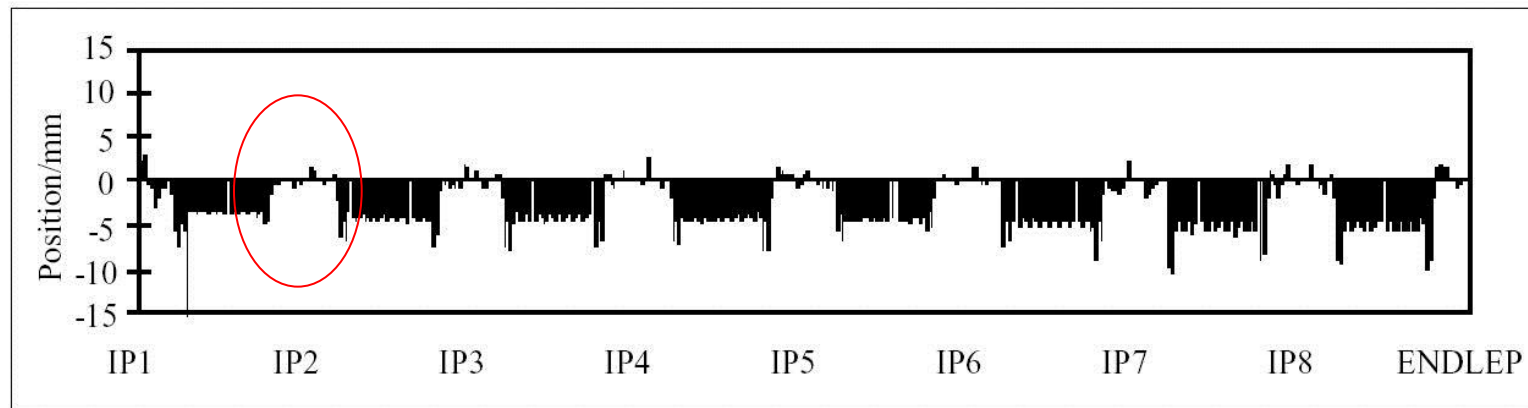

Optimized Horizontal First Turn Trajectory for Synchrotron Injection of Positrons with $\Delta P/P$ at -0.6%

Synchrotron Injection in LEP gave improved background for LEP experiments due to small orbit offsets in zero dispersion straight sections

Injection - summary

- Several different techniques
 - Single-turn injection for hadrons
 - Boxcar stacking: transfer between machines in accelerator chain
 - Angle / position errors \Rightarrow injection oscillations
 - Optics errors \Rightarrow betatron mismatch oscillations
 - Oscillations \Rightarrow filamentation \Rightarrow emittance increase
 - Multi-turn injection for hadrons
 - Phase space painting to increase intensity
 - H- injection allows injection into same phase space area
 - Lepton injection: take advantage of damping
 - Less concerned about injection precision and matching

Extraction

- Different extraction techniques exist, depending on requirements
 - Fast extraction: ≤ 1 turn
 - Non-resonant multi-turn extraction: few turns
 - Resonant multi-turn extraction: many thousands of turns
 - Resonant low-loss multi-turn extraction: few turns
- Usually higher energy than injection \Rightarrow stronger elements ($\int B \cdot dl$)
 - At high energies many kicker and septum modules may be required
 - To reduce kicker and septum strength, beam can be moved near to septum by closed orbit bump

Fast single turn extraction

Whole beam kicked into septum gap and extracted.

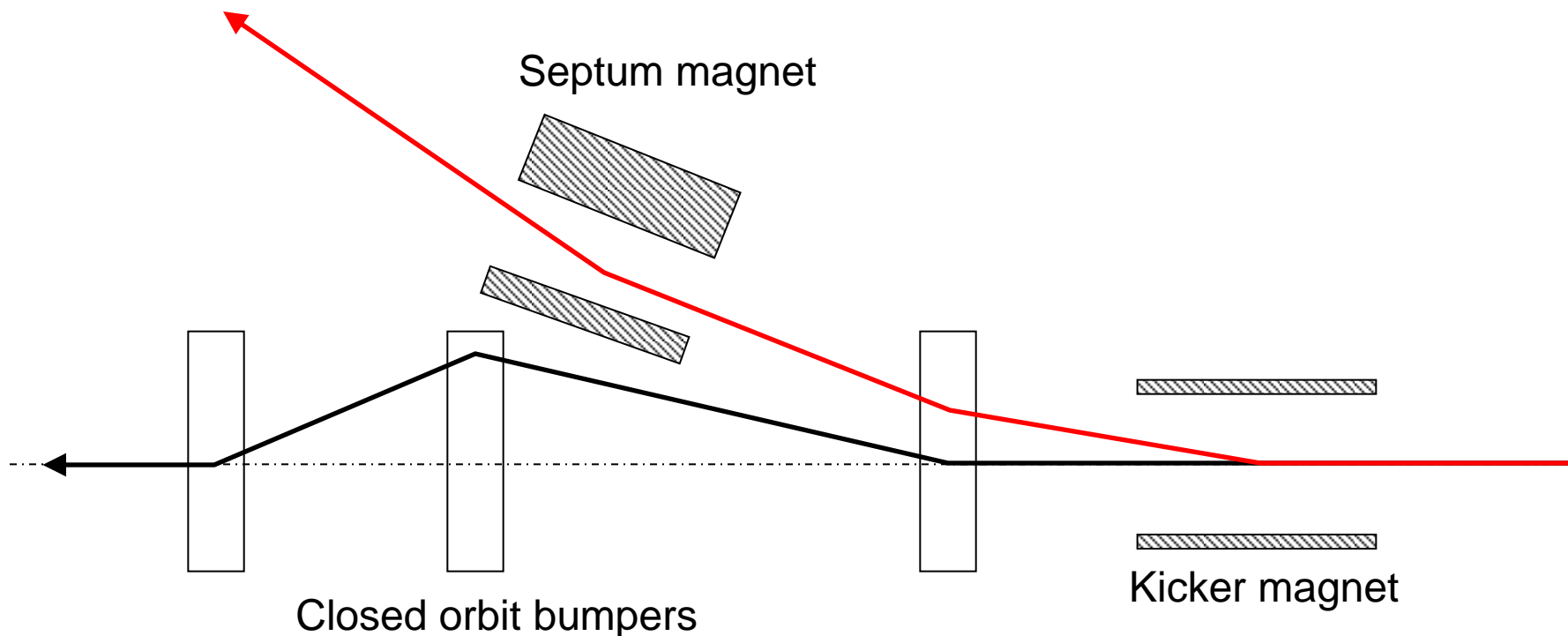

- Kicker deflects the entire beam into the septum in a single turn
- Septum deflects the beam entire into the transfer line
- Most efficient (lowest deflection angles required) for $\pi/2$ phase advance between kicker and septum

Fast single turn extraction

- For transfer of beams between accelerators in an injector chain.
- For secondary particle production (e.g. neutrinos)
- Septum deflection may be in the other plane to the kicker deflection.
- Losses from transverse scraping or from particles in extraction gap

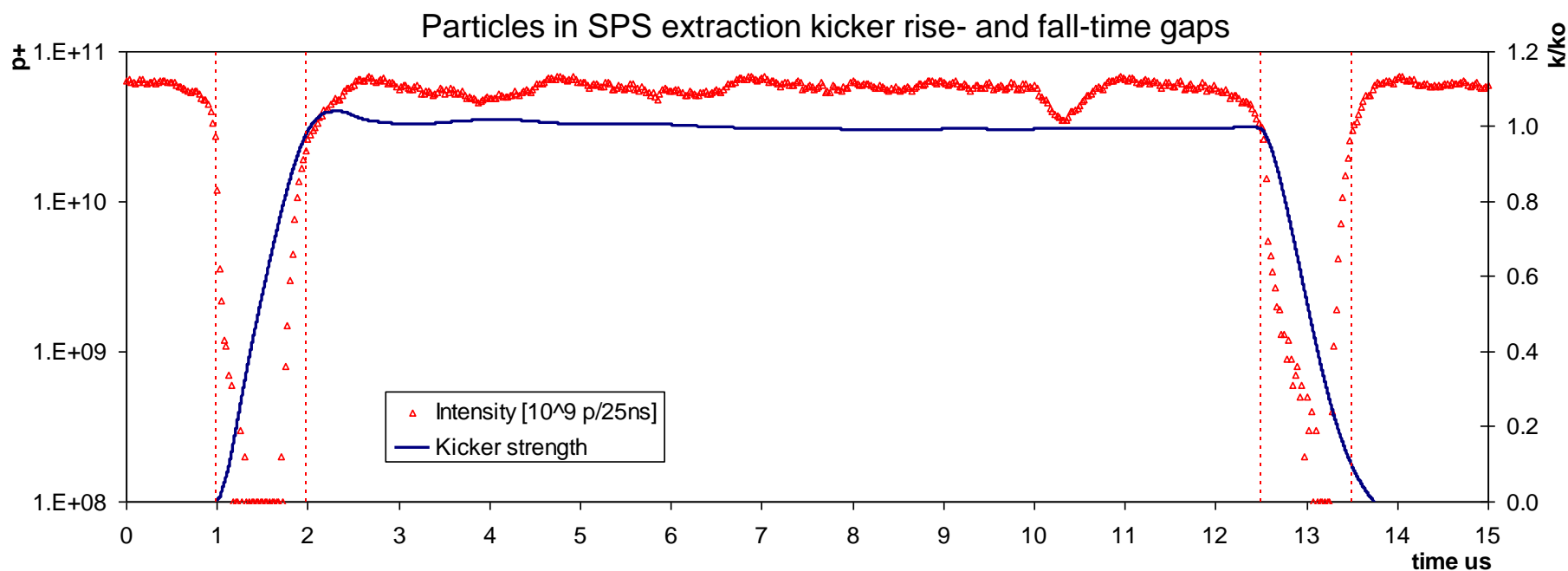

Synchronisation I

- Beam from PS has to be injected into right SPS bucket wrt to SPS revolution frequency
- Set frequency
 - Before beam is transferred, e.g. from SPS to LHC, the two machines must be synchronised on a common frequency f_c

$$f_c = \frac{f_{rev}^{SPS}}{27} = \frac{f_{rev}^{LHC}}{7}$$

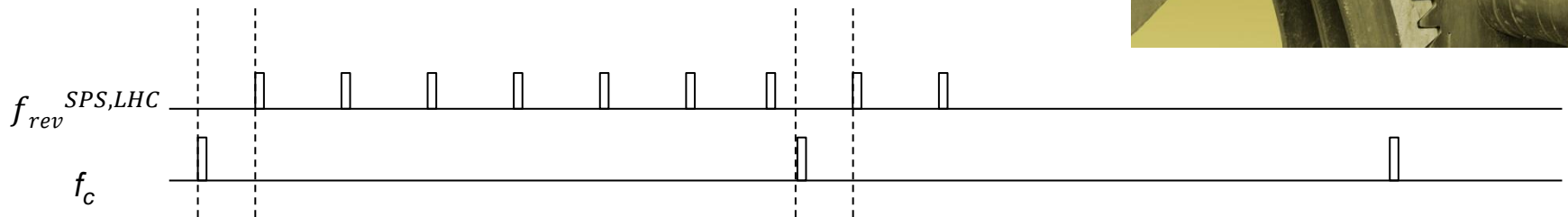

- Now the LHC can choose the bucket in which the first bunch will be injected
→ SPS must shift the beam to adapt to this position

Synchronisation II

- “Coarse” rephasing
 - Shift the beam in the SPS to reach wanted LHC bucket
 - To do so the particles will run for a short period on an average radius which is different from the central orbit (“radial steering”)
 - Matching of common frequency f_c with SPS revolution frequency (TDC)
- “Fine” rephasing – phase matching
 - Correct the position within the bucket
 - Matching of f_{RF}^{LHC} and f_{RF}^{SPS} (phase lock loop)

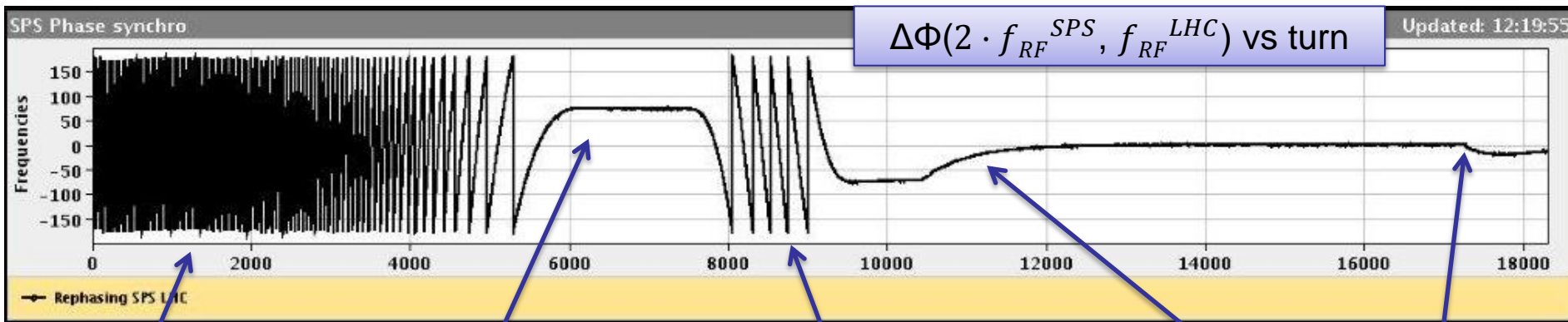
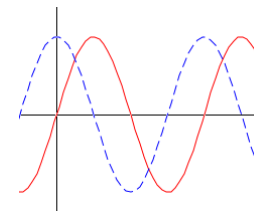

Set frequency

Constant frequency offset

Coarse rephasing

Fine rephasing

Extraction

Synchronisation III

- Triggering the SPS extraction and LHC injection kickers
 - Timing event: has only 1ms resolution; serves as prepulse;
 - With f_c calculate exact timing of kicker pulse for SPS and LHC

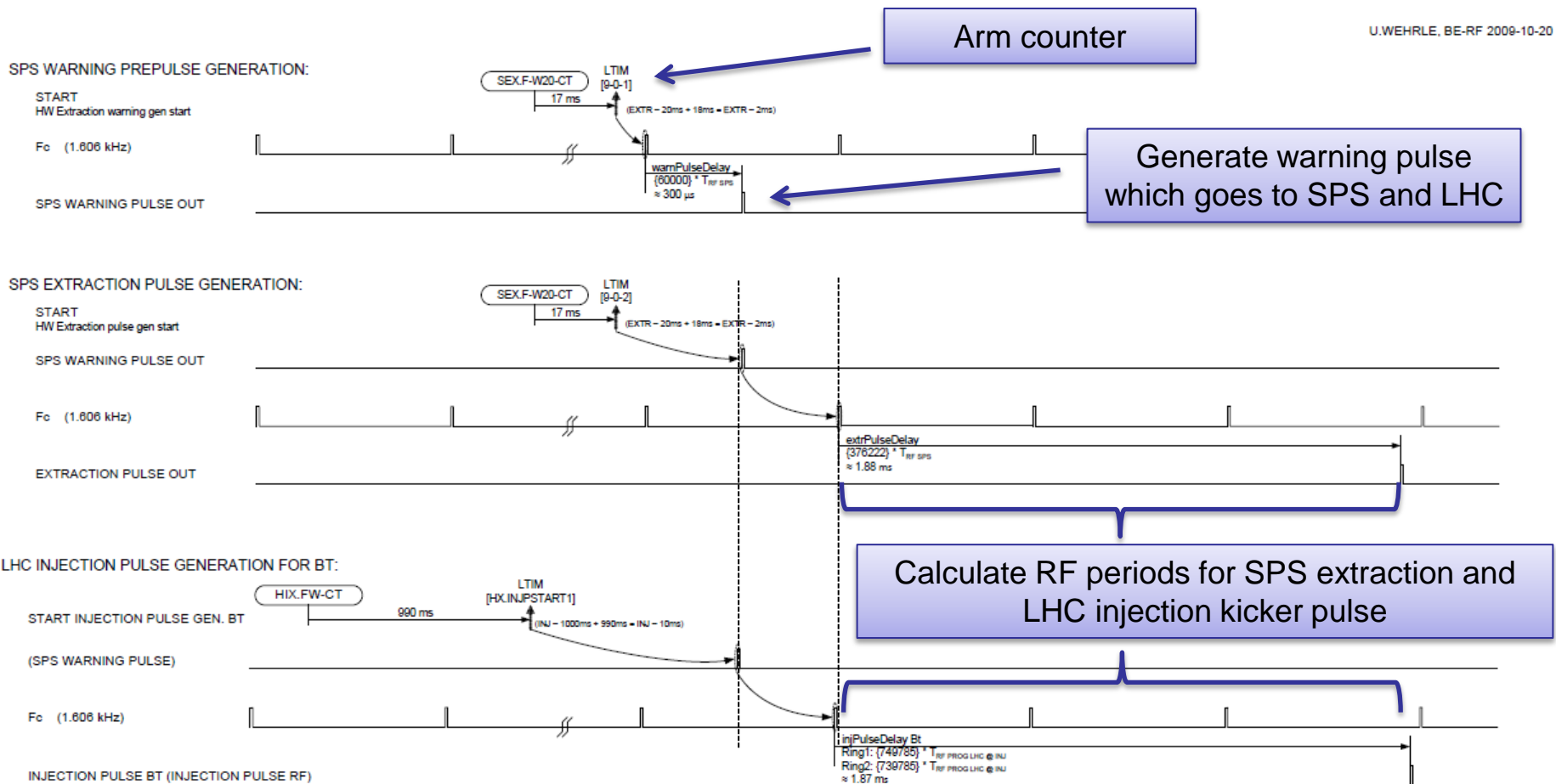

Multi-turn extraction

- Some filling schemes require a beam to be injected in several turns to a larger machine...
- And very commonly Fixed Target physics experiments and medical accelerators often need a quasi-continuous flux of particles...
- Multi-turn extraction...
 - Non-Resonant multi-turn ejection (few turns) for filling e.g. PS to SPS at CERN for high intensity proton beams ($>2.5 \cdot 10^{13}$ protons)
 - Resonant extraction (ms to hours) for experiments

Non-resonant multi-turn extraction

Beam bumped to septum; part of beam 'shaved' off each turn.

Extracted beam

Septum

Bumped circulating beam

Fast closed orbit bumpers

- Fast bumper deflects the whole beam onto the septum
- Beam extracted in a few turns, with the machine tune rotating the beam
- Intrinsically a high-loss process – thin septum essential

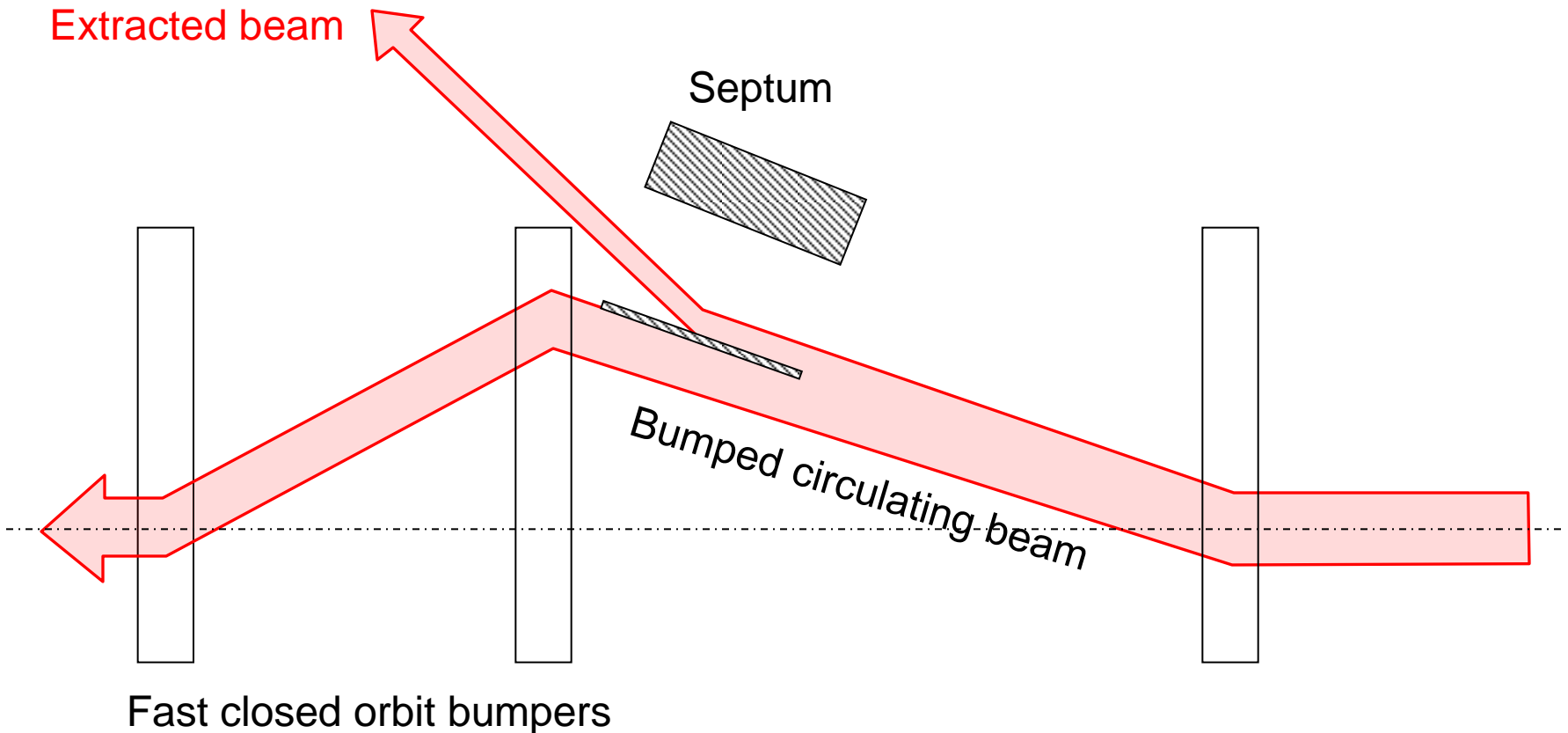

Non-resonant multi-turn extraction

- Example system: CERN PS to SPS Fixed-Target 'continuous transfer'.
 - Accelerate beam in PS to 14 GeV/c
 - Empty PS machine (2.1 μs long) in 5 turns into SPS
 - Do it again
 - Fill SPS machine (23 μs long)
 - Quasi-continuous beam in SPS (2 x 1 μs gaps)
 - Total intensity per PS extraction $\approx 3 \times 10^{13}$ p+
 - Total intensity in SPS $\approx 5 \times 10^{13}$ p+

Non-resonant multi-turn extraction

CERN PS to SPS: 5-turn continuous transfer

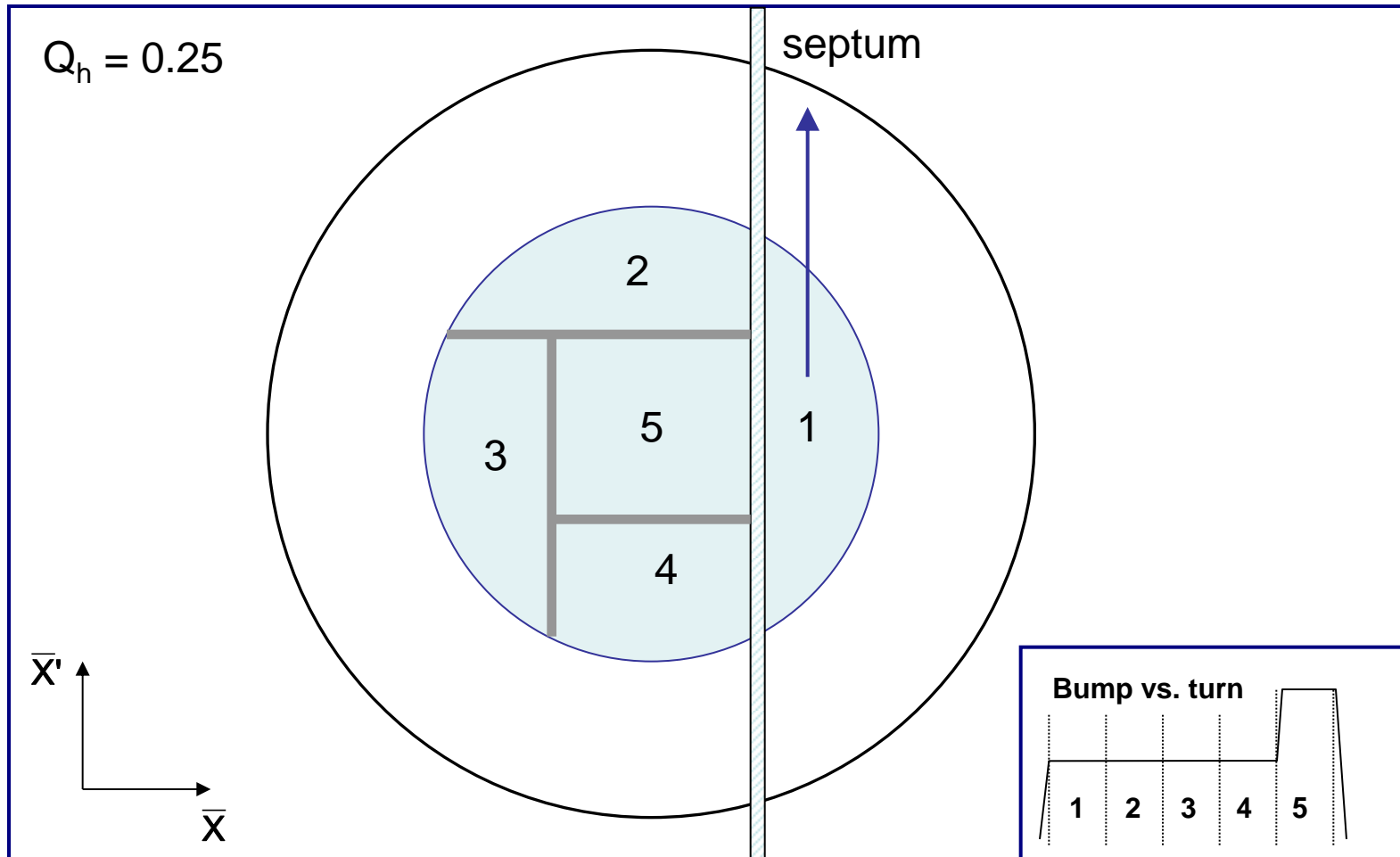

Non-resonant multi-turn extraction

CERN PS to SPS: 5-turn continuous transfer – 5th turn

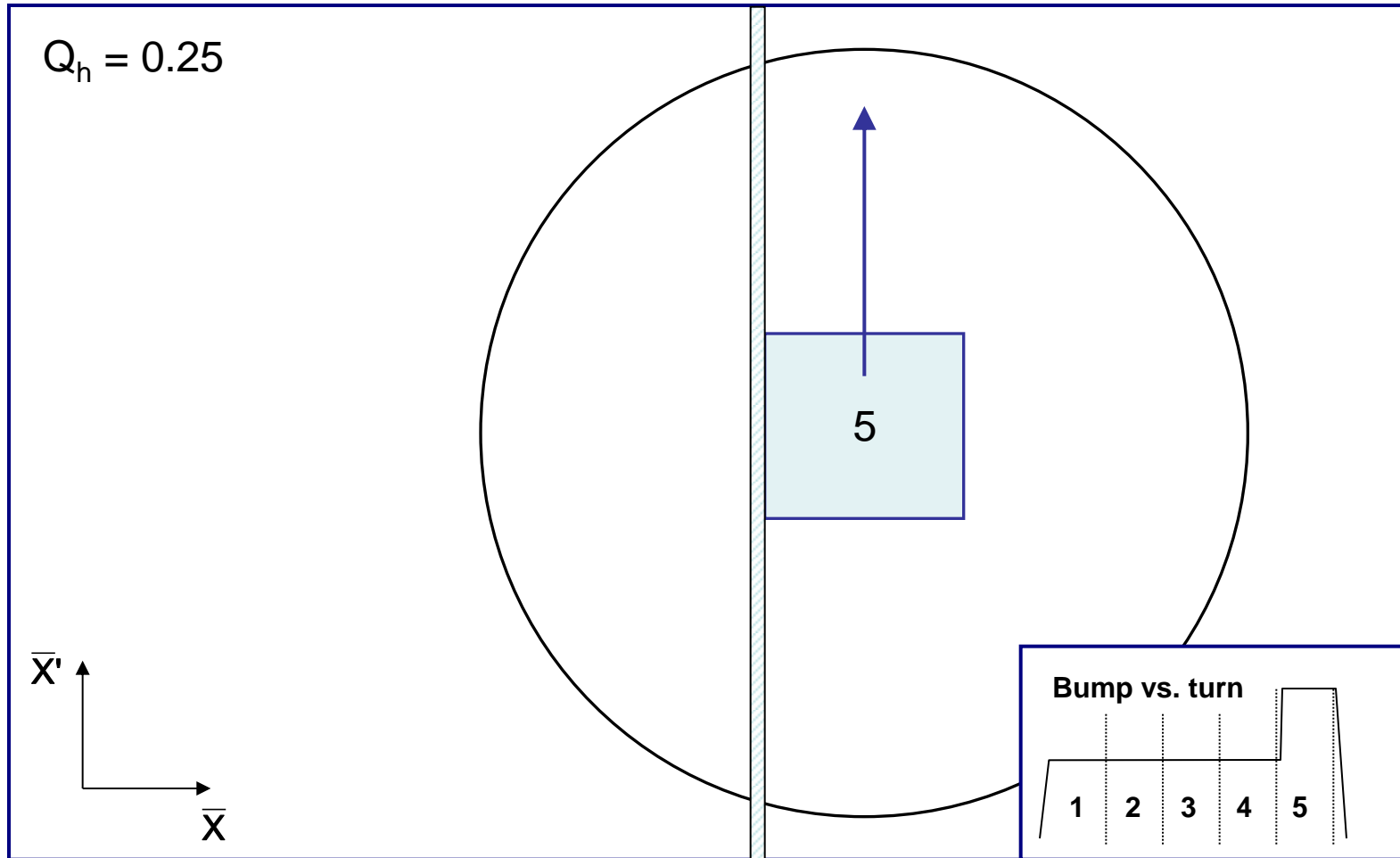

Non-resonant multi-turn extraction

- CERN PS to SPS: 5-turn continuous transfer
 - Losses impose thin (ES) septum... second septum needed
 - Still about 15 % of beam lost in PS-SPS CT
 - Difficult to get equal intensities per turn
 - Different trajectories for each turn
 - Different emittances for each turn

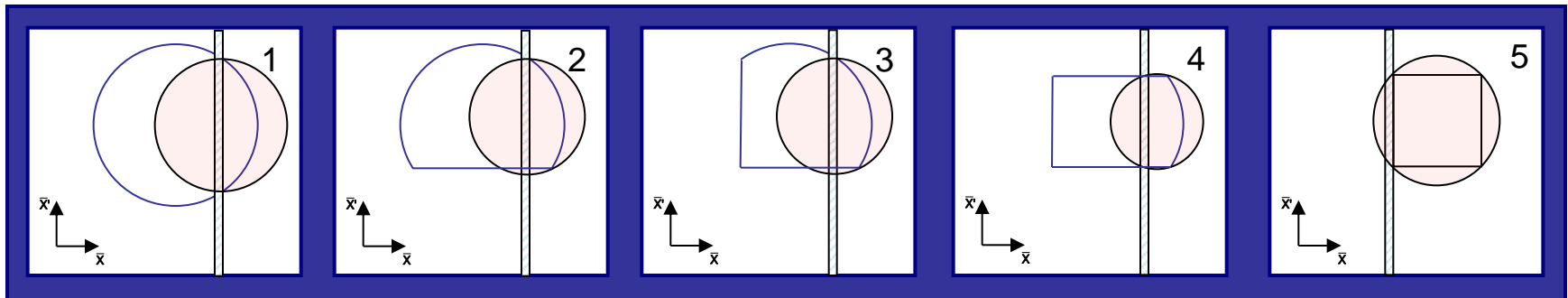
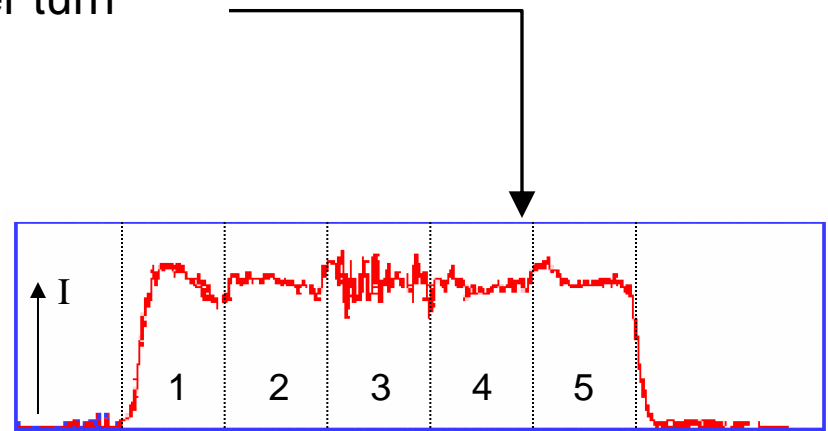

Resonant multi-turn extraction

Non-linear fields excite resonances which drive the beam slowly across the septum.

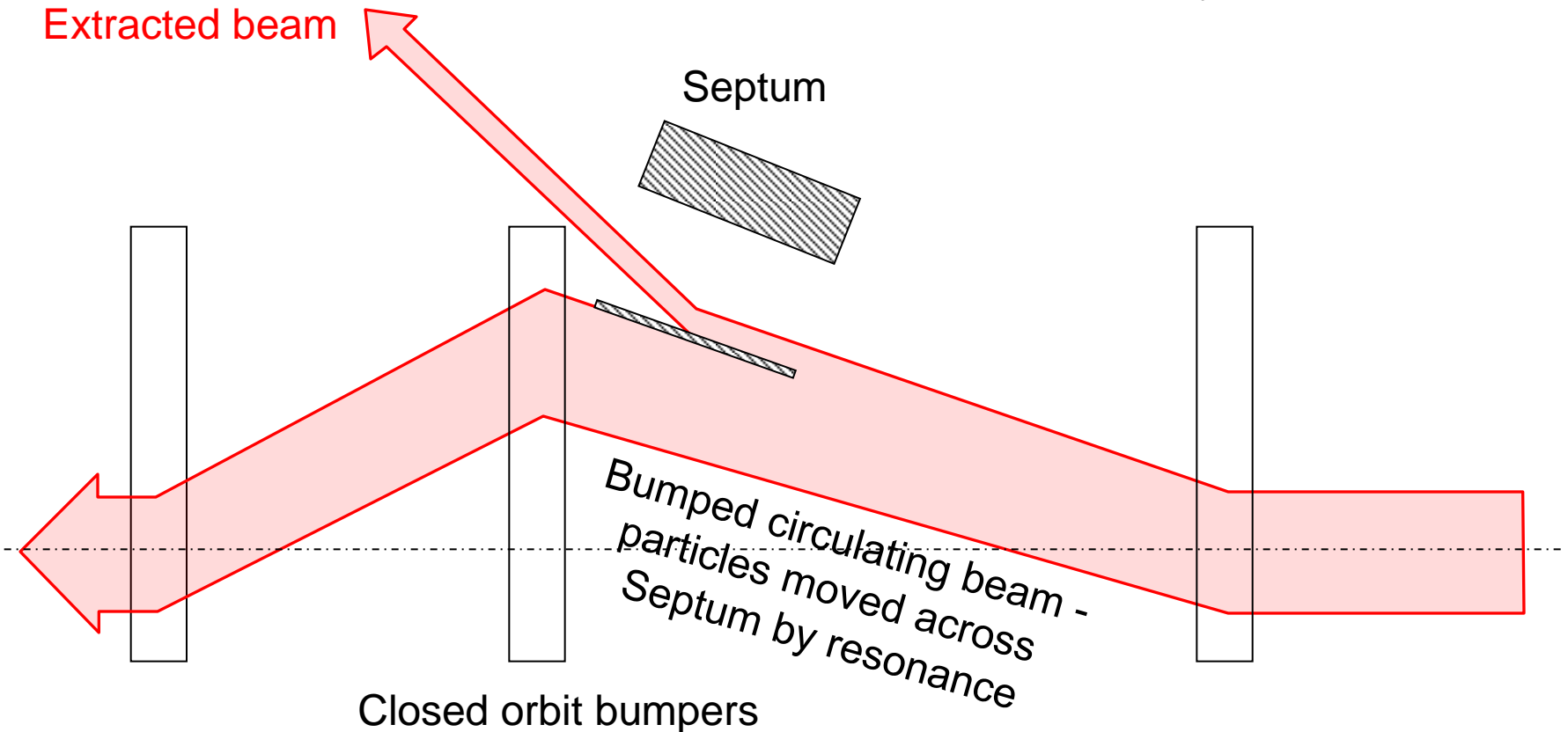

- Slow bumpers move the beam near the septum
- Tune adjusted close to n^{th} order betatron resonance
- Multipole magnets excited to define stable area in phase space, size depends on $\Delta Q = Q - Q_r$

Resonant multi-turn extraction

- 3rd order resonances
 - Sextupole fields distort the circular normalised phase space particle trajectories.
 - Stable area defined, delimited by unstable Fixed Points.

$$R_{fp}^{1/2} \propto \Delta Q \cdot \frac{1}{k_2}$$

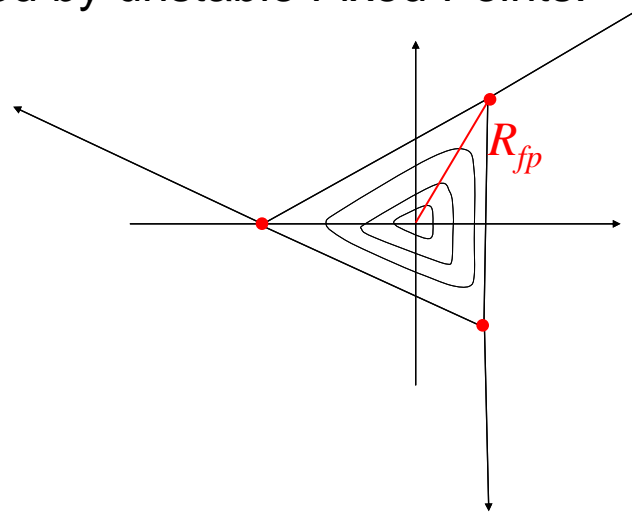

- Sextupoles families arranged to produce suitable phase space orientation of the stable triangle at thin electrostatic septum
- Stable area can be reduced by increasing the sextupole strength, or (easier) by approaching machine tune Q_h to resonant 1/3 integer tune
- Reducing ΔQ with main machine quadrupoles can be augmented with a 'servo' quadrupole, which can modulate ΔQ in a servo loop, acting on a measurement of the spill intensity

Third-order resonant extraction

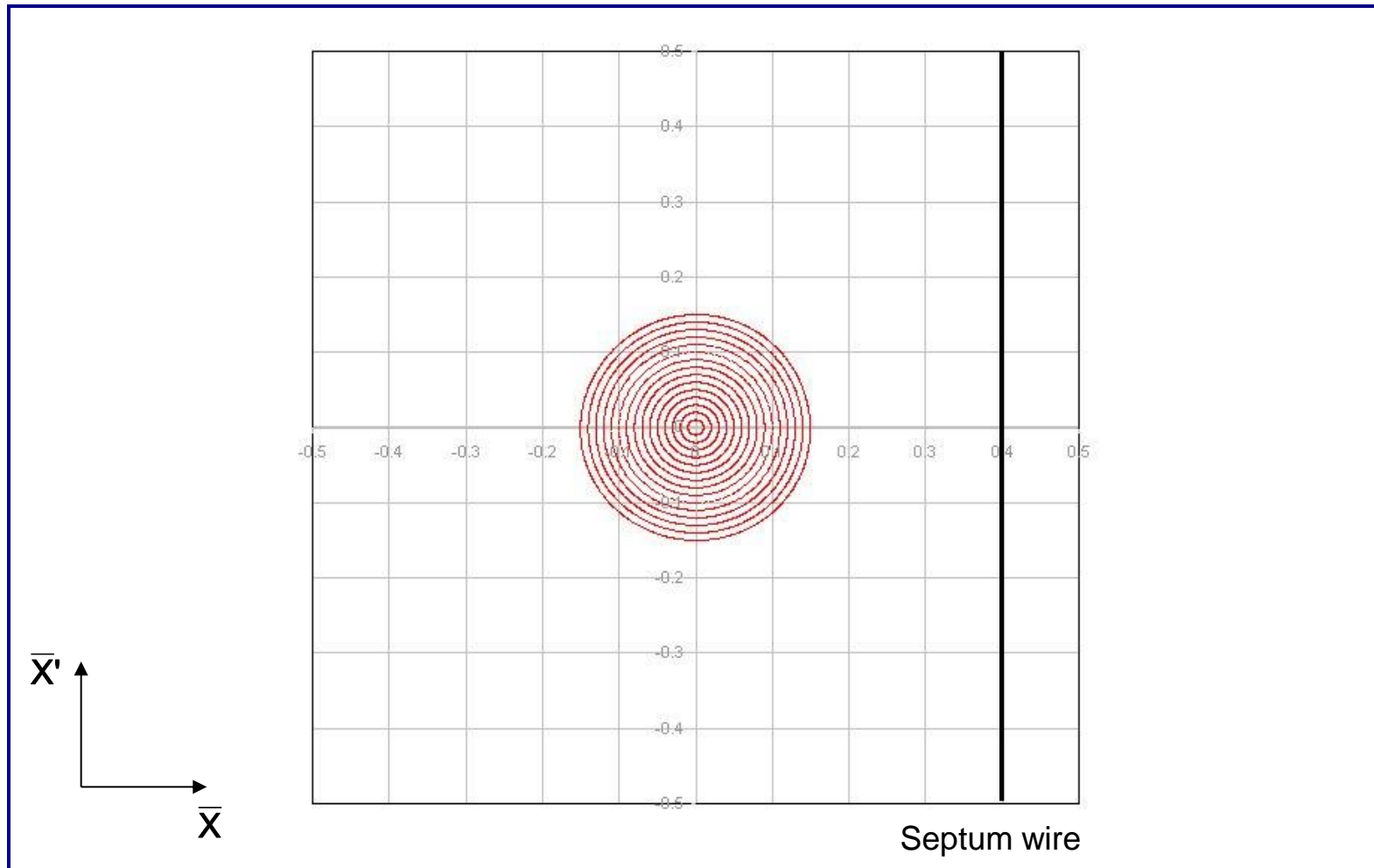

- Particles distributed on emittance contours
- ΔQ large – no phase space distortion

Third-order resonant extraction

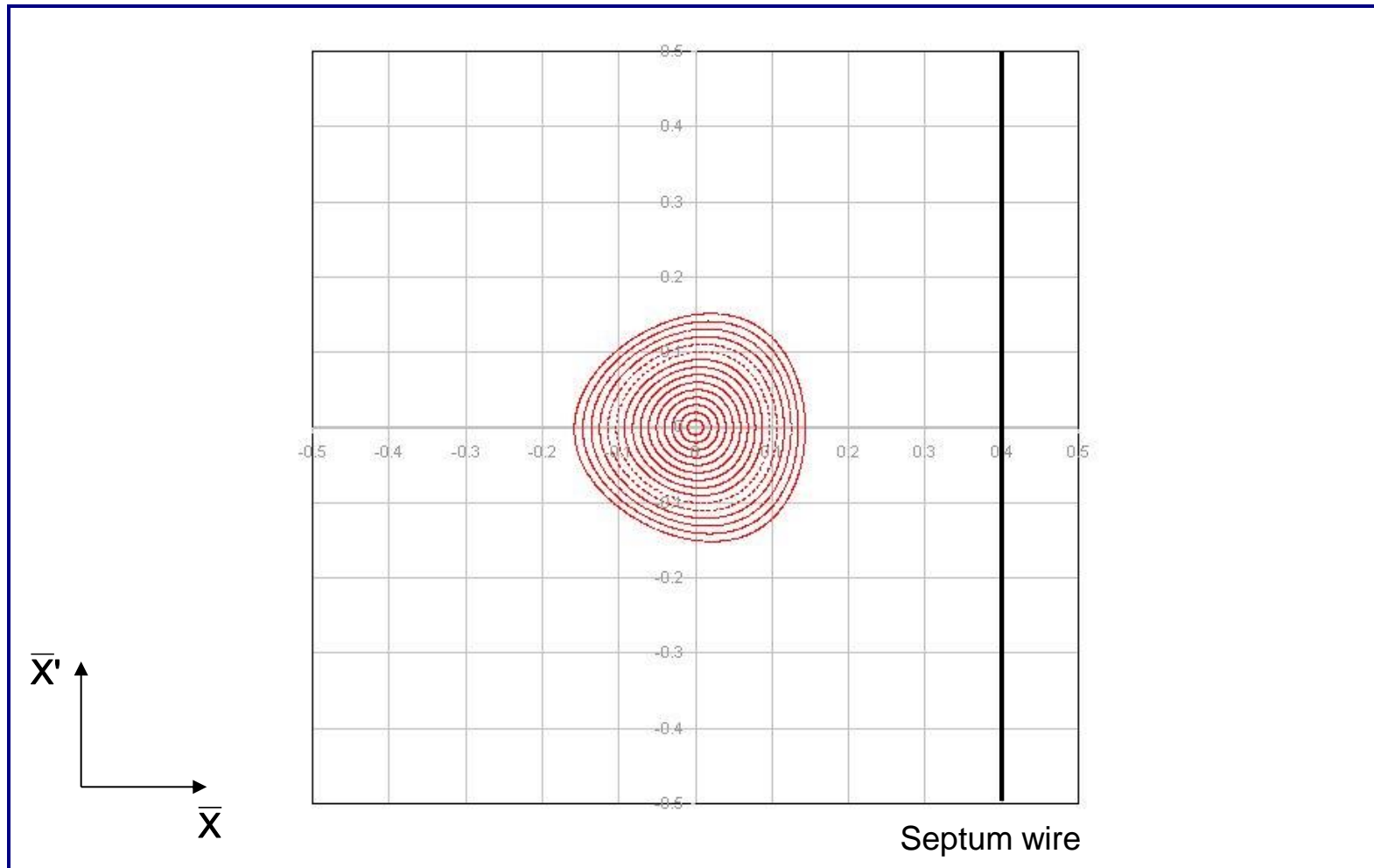

- Dedicated sextupole magnets produce a triangular stable area in phase space
- ΔQ decreasing – phase space distortion for largest amplitudes

Third-order resonant extraction

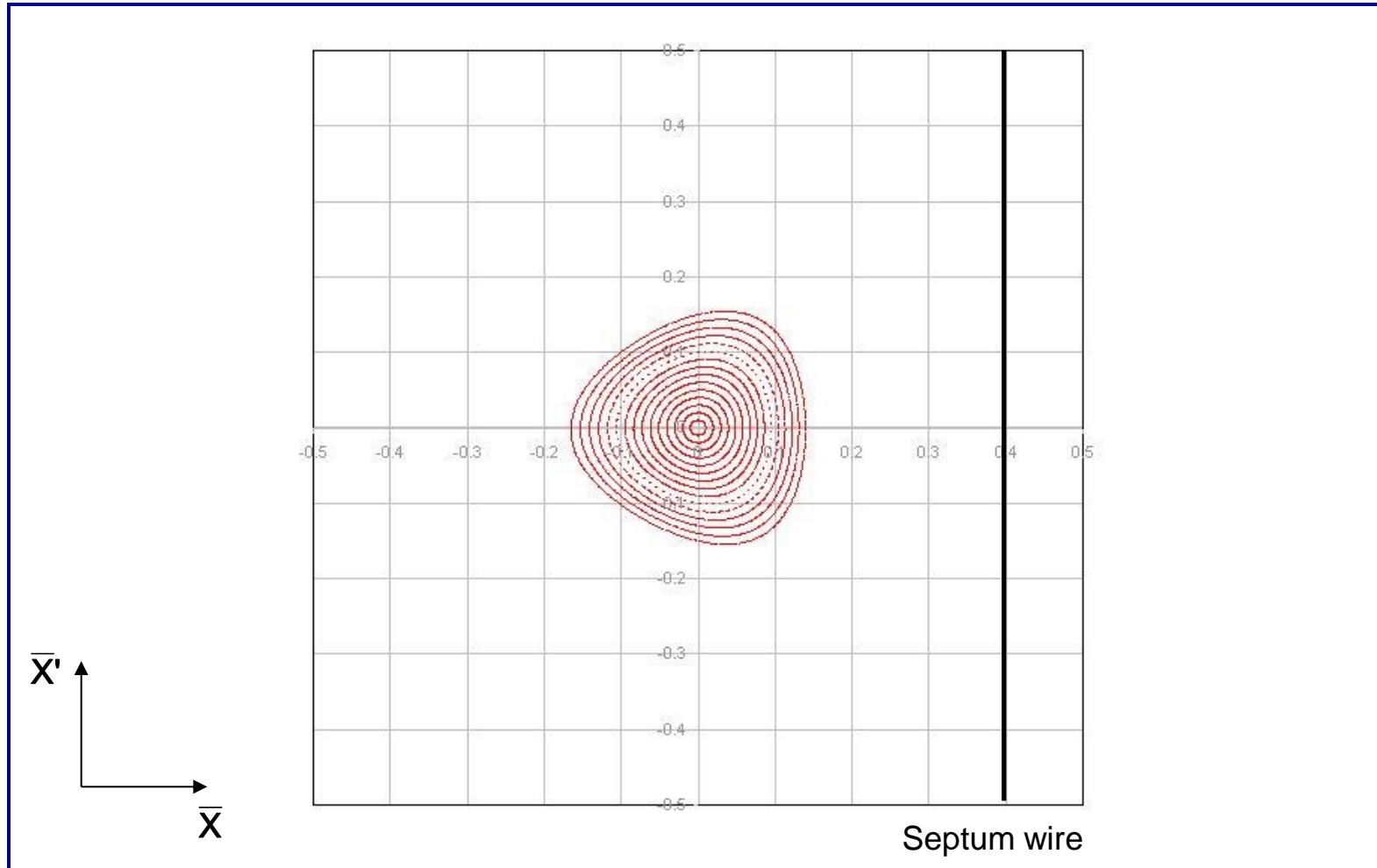

Third-order resonant extraction

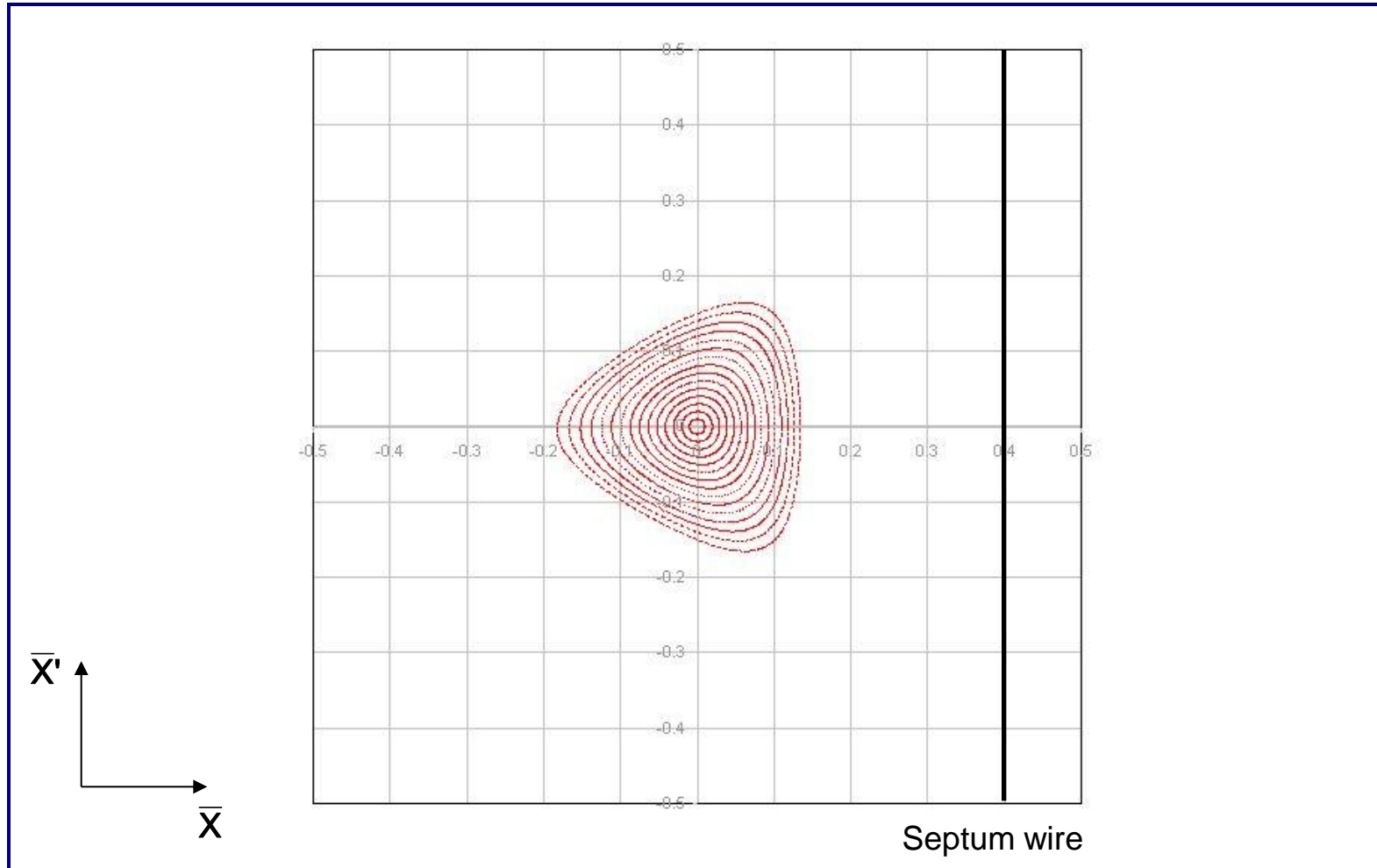

Third-order resonant extraction

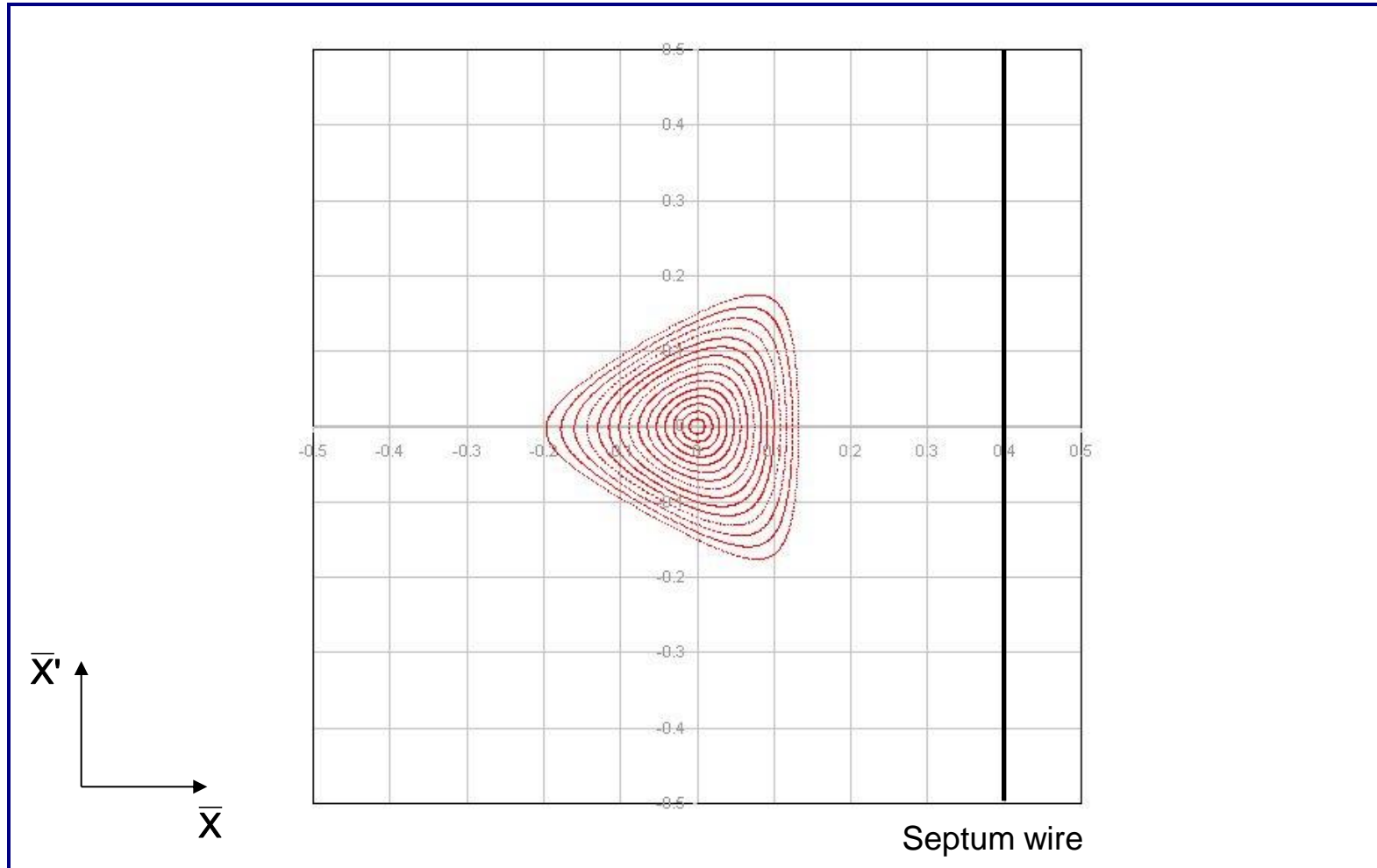

Third-order resonant extraction

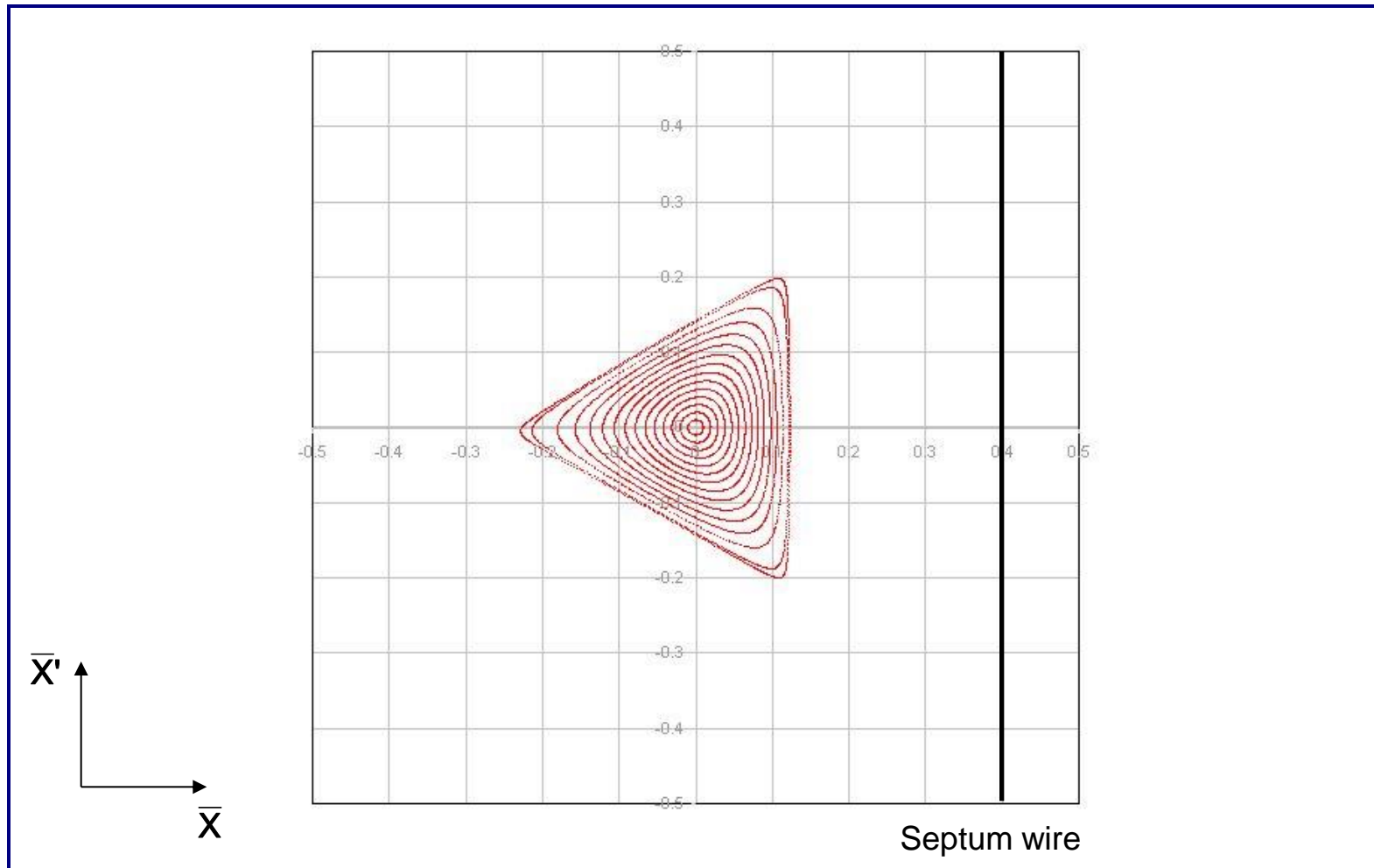

- ΔQ small enough that largest amplitude particles are close to the separatrices
- Fixed points locations discernable at extremities of phase space triangle

Third-order resonant extraction

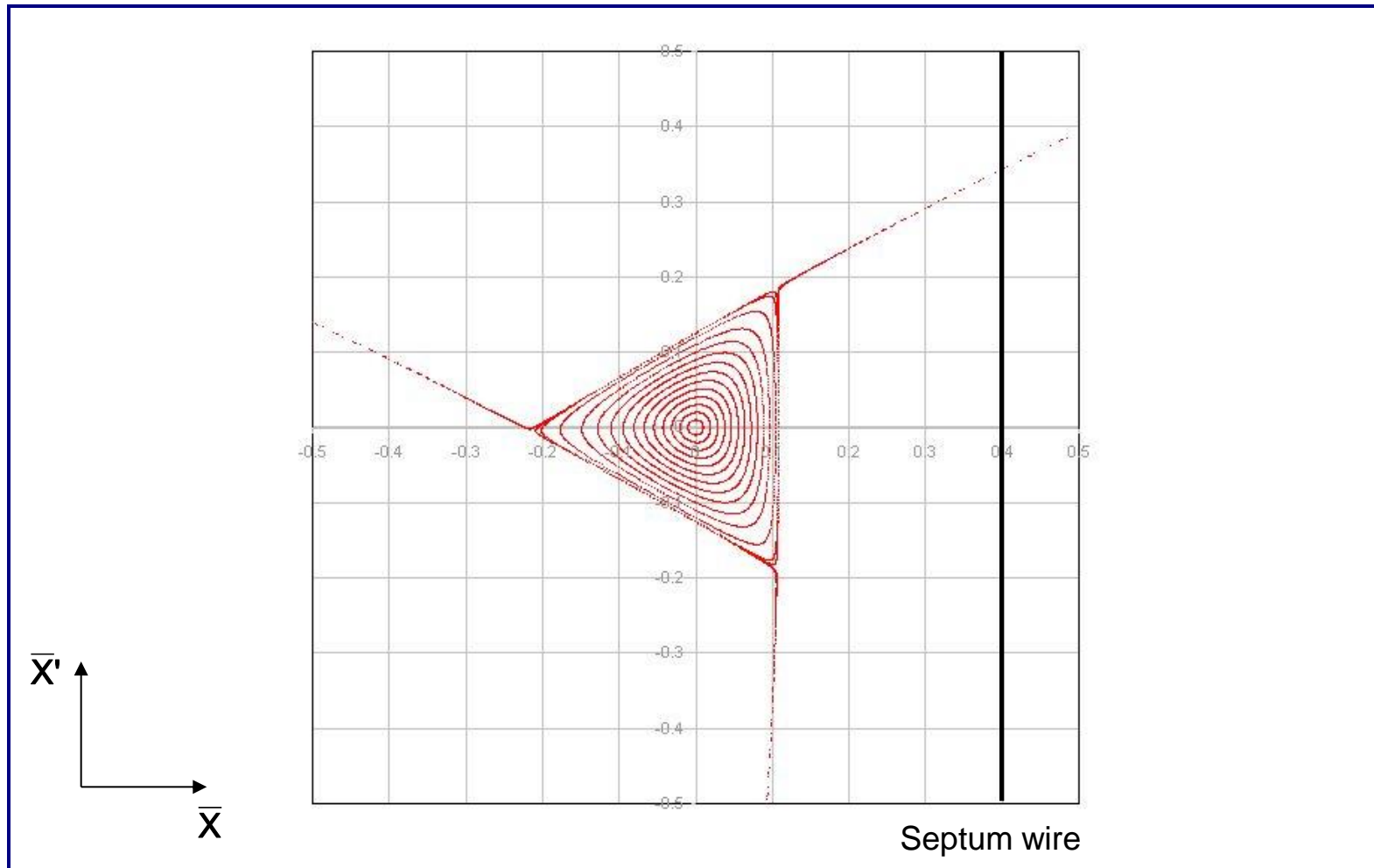

- ΔQ now small enough that largest amplitude particles are unstable
- Unstable particles follow separatrix branches as they increase in amplitude

Third-order resonant extraction

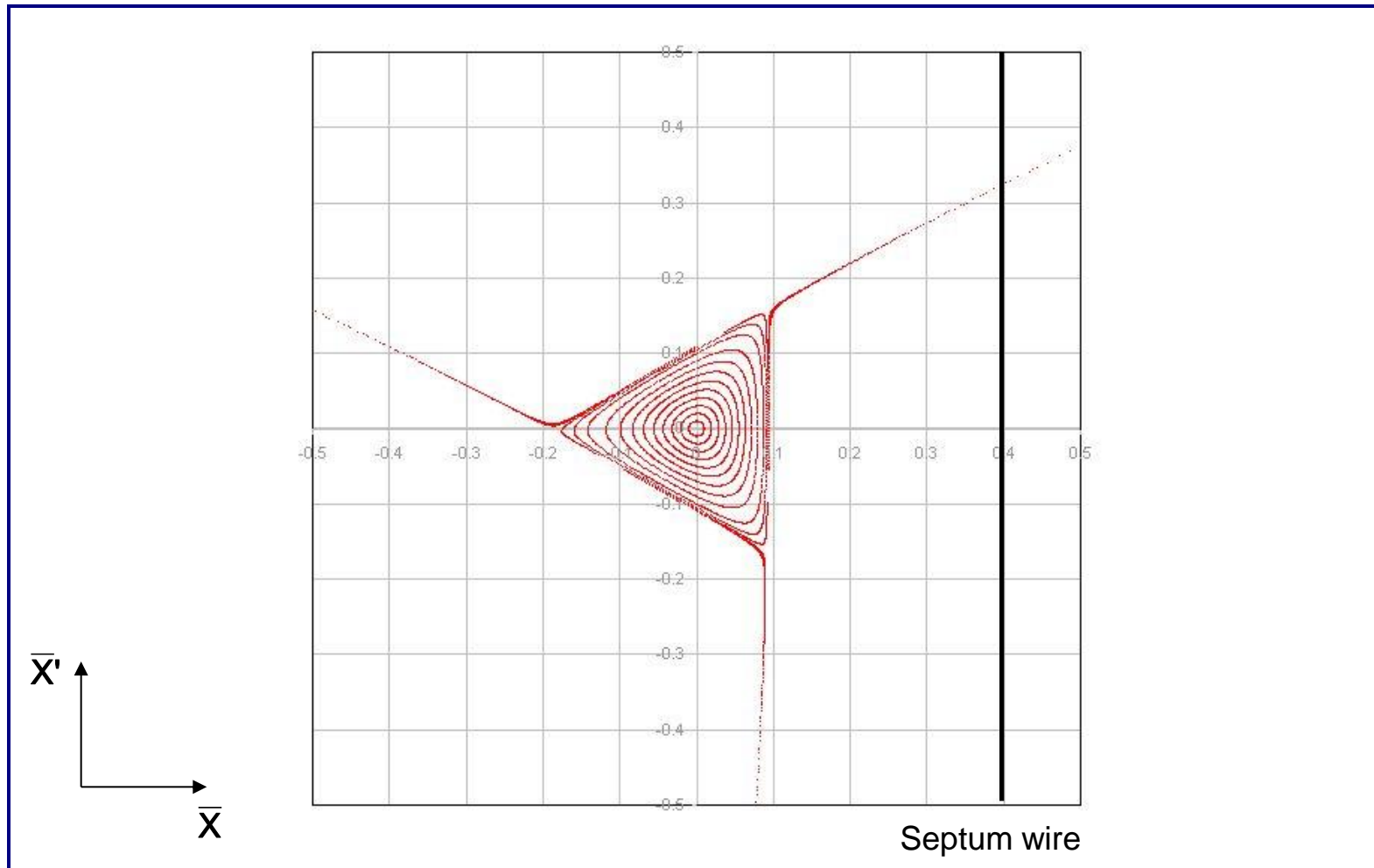

- Stable phase area shrinks as ΔQ gets smaller

Third-order resonant extraction

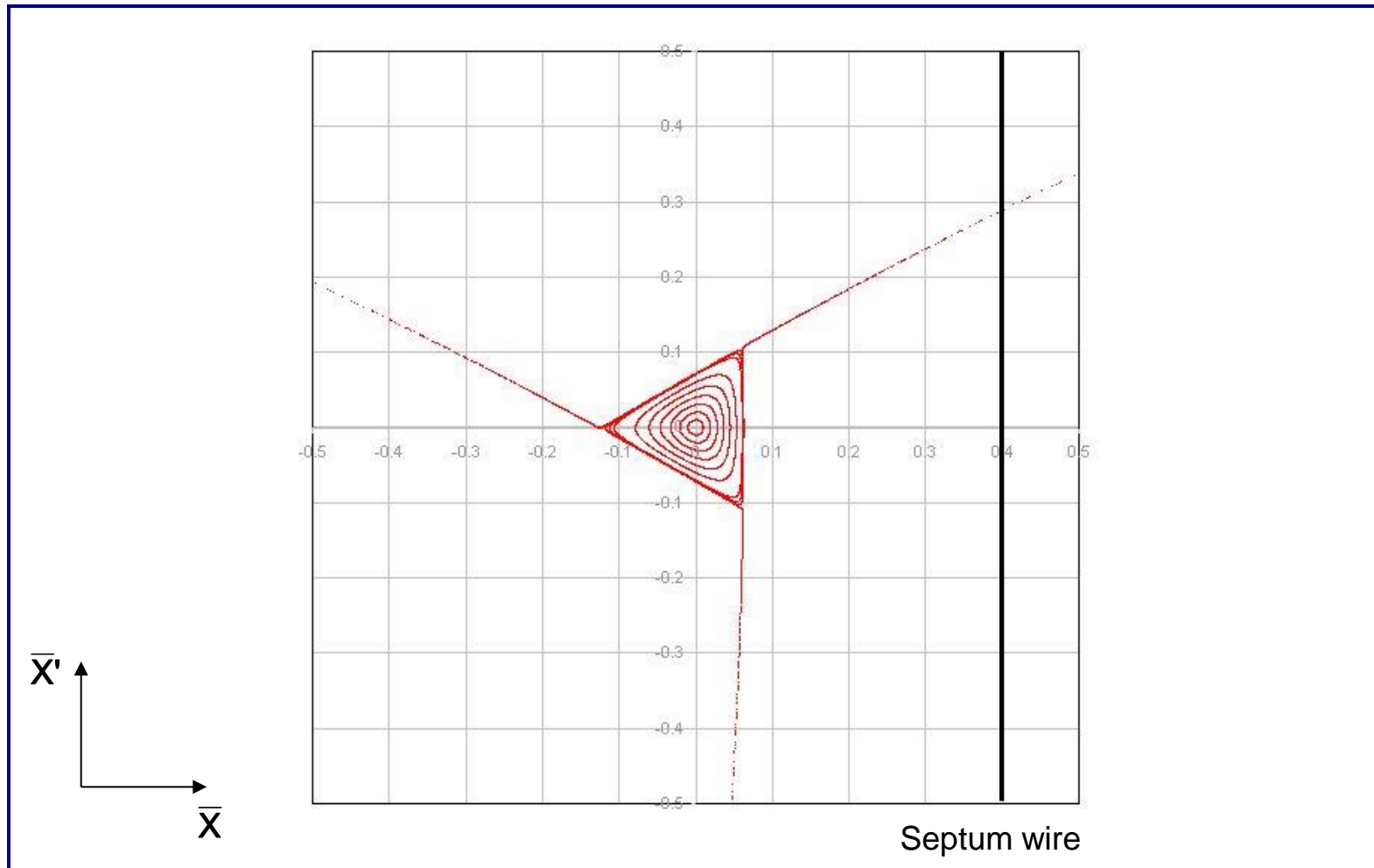

- Separatrix position in phase space shifts as the stable area shrinks

Third-order resonant extraction

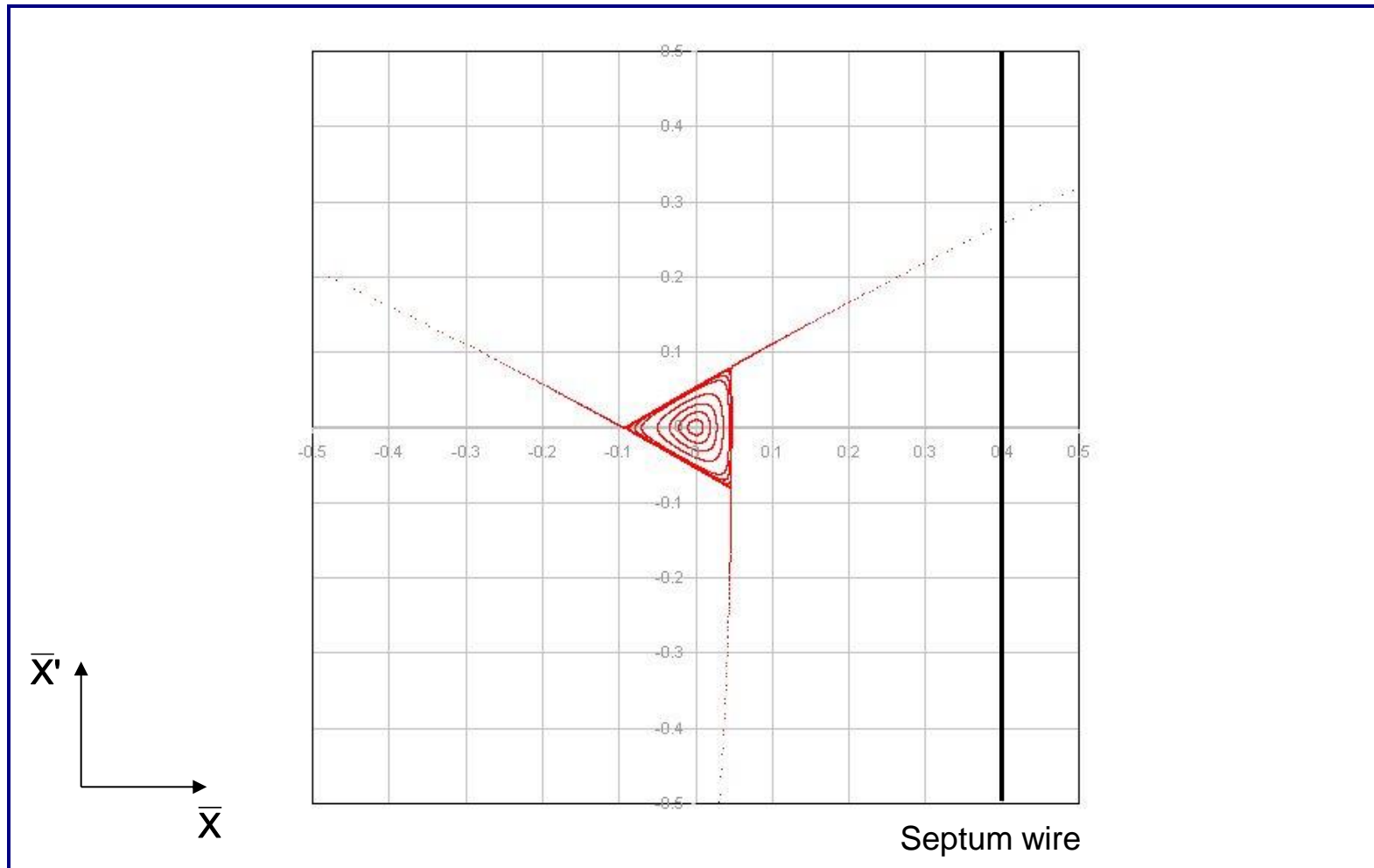

- As the stable area shrinks, the beam intensity drops since particles are being continuously extracted

Third-order resonant extraction

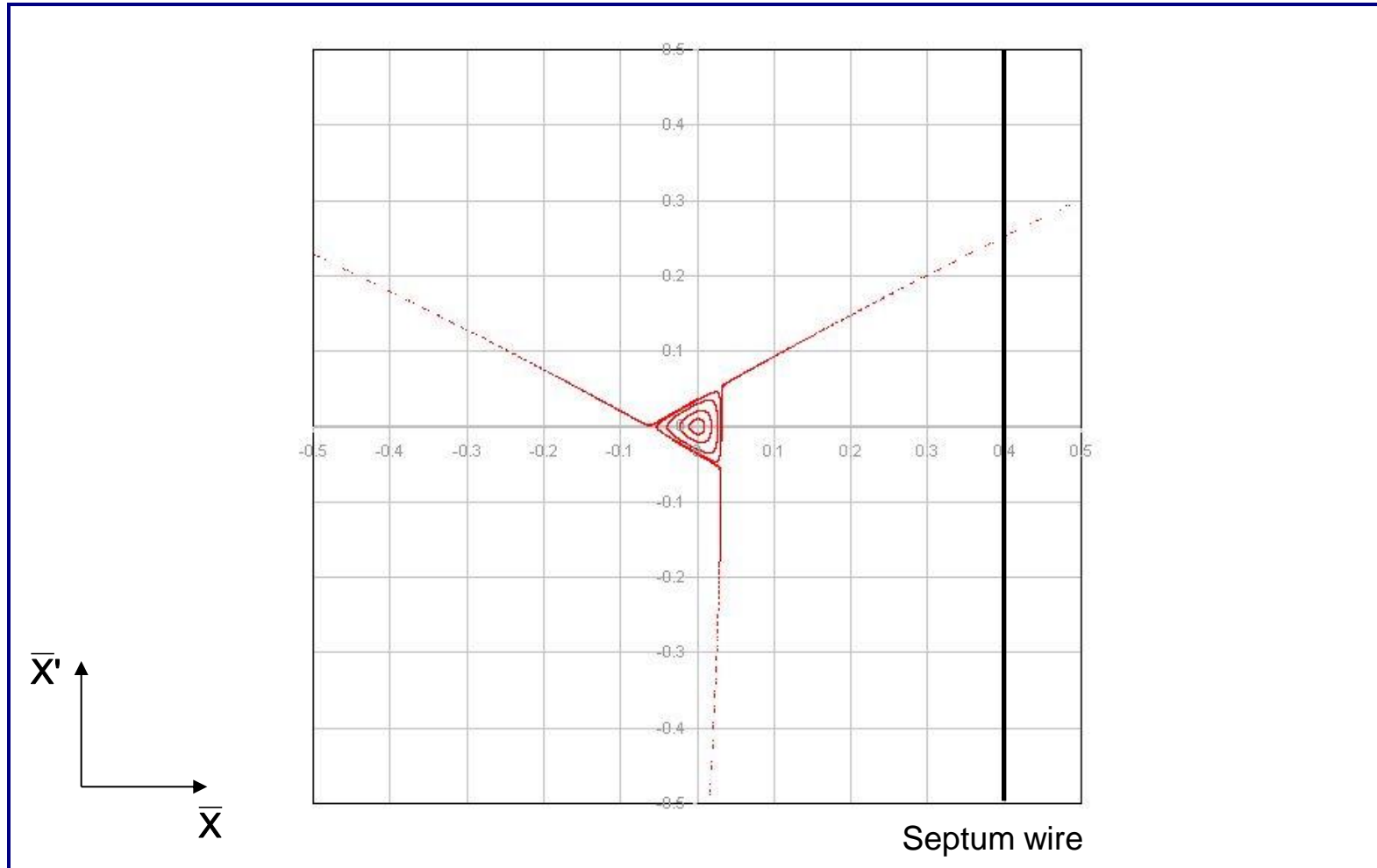

Third-order resonant extraction

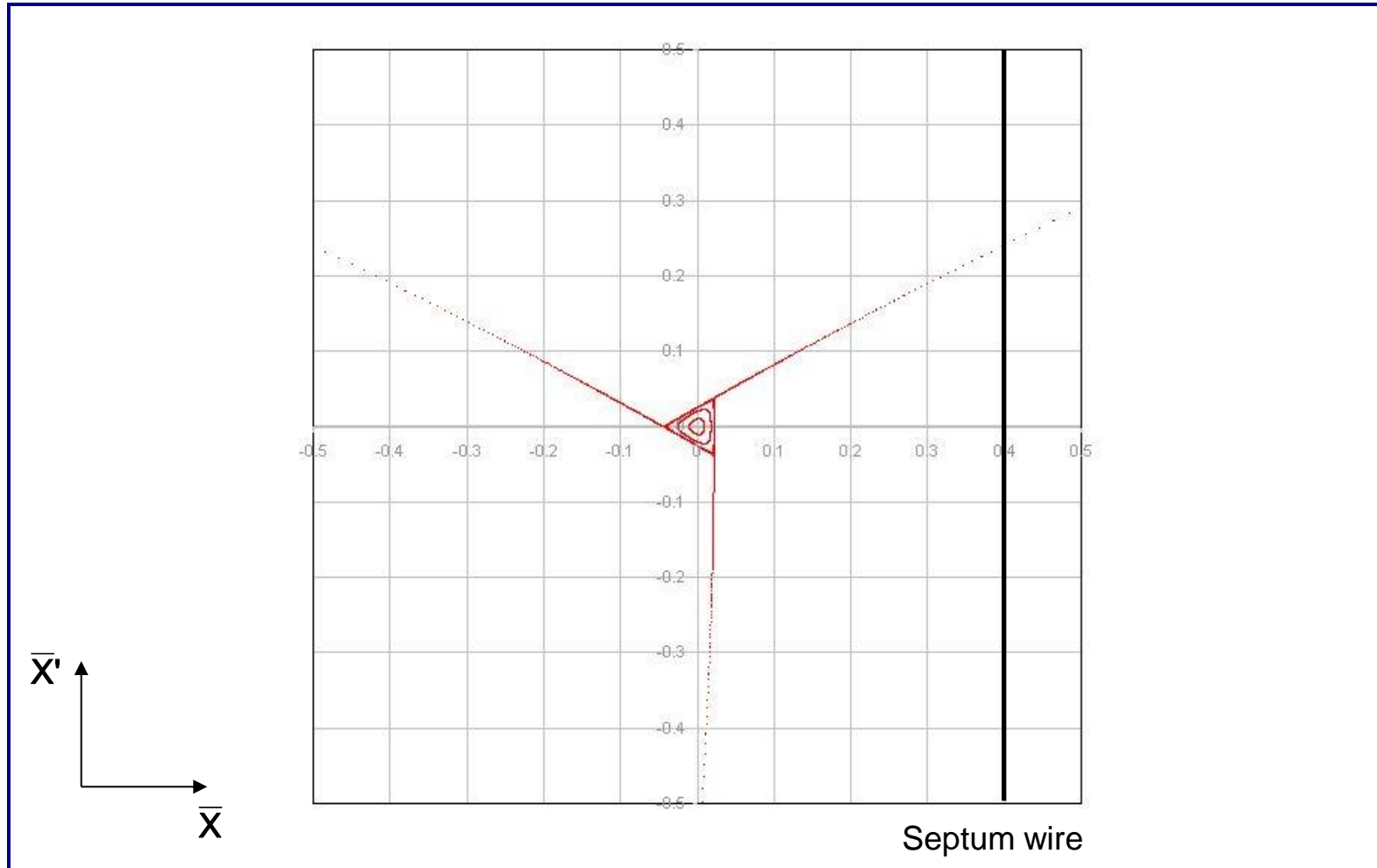

Third-order resonant extraction

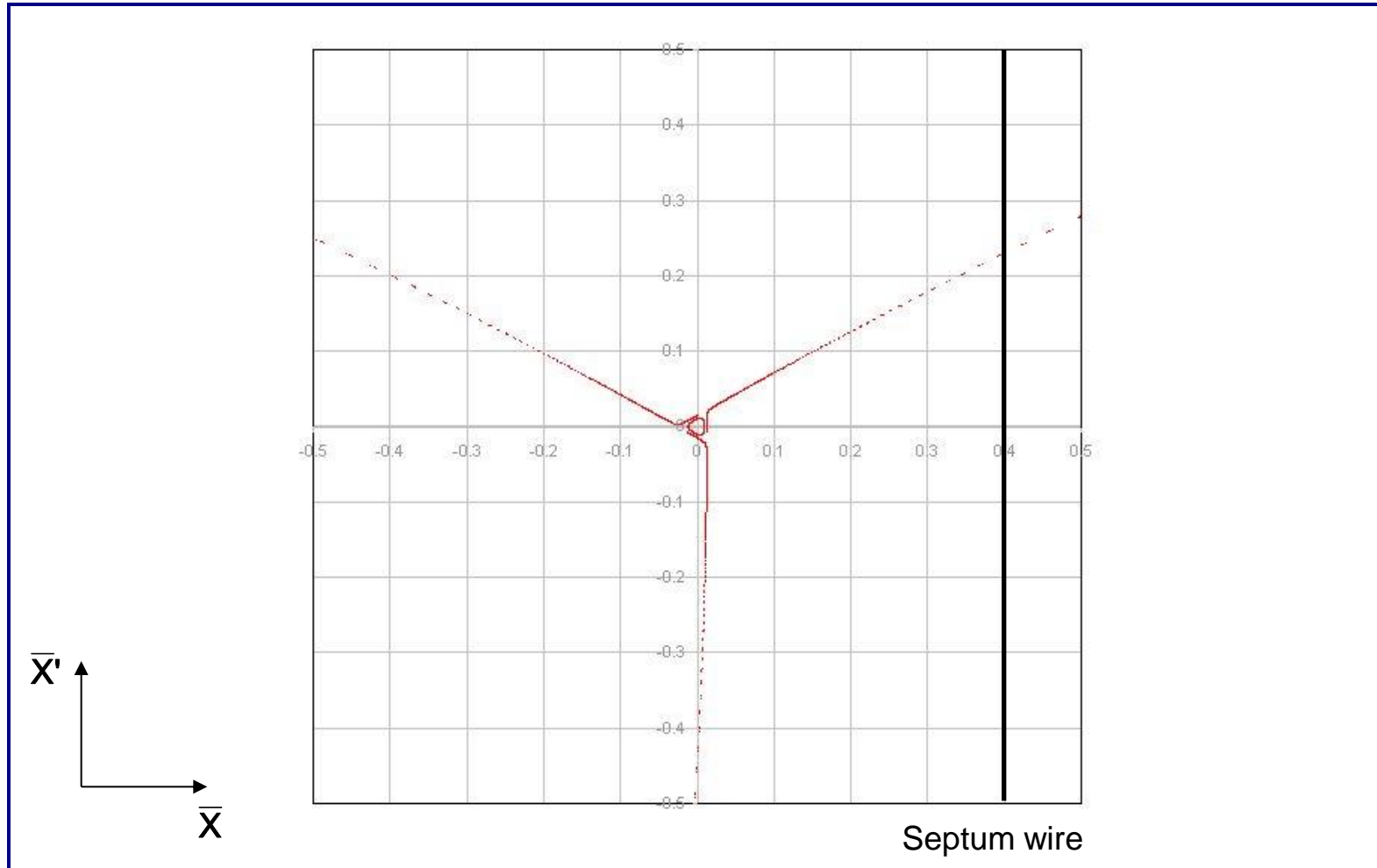

Third-order resonant extraction

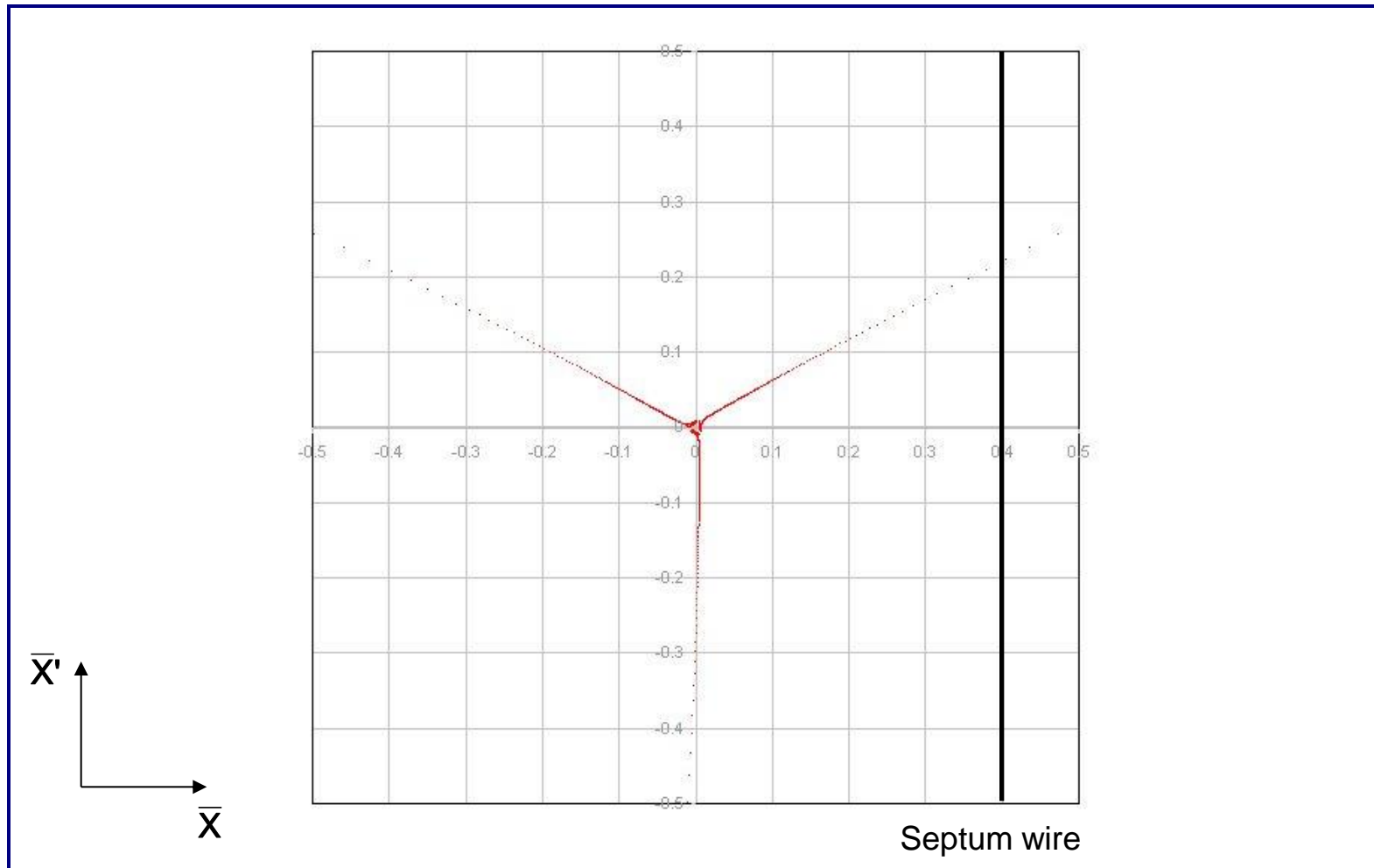

- As ΔQ approaches zero, the particles with very small amplitude are extracted.

Third-order resonant extraction

Example – SPS slow extraction at 450 GeV/c.

$\sim 3 \times 10^{13}$ p+ extracted in a 2-4 second long spill ($\sim 200,000$ turns)

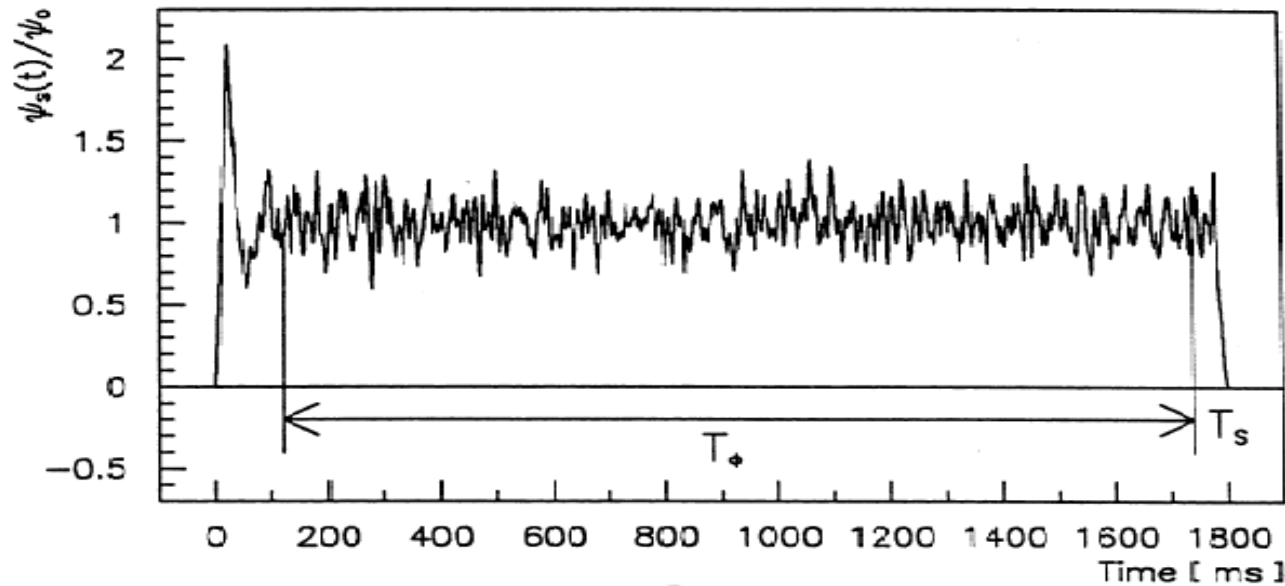

Intensity vs time:
 $\sim 10^8$ p+ extracted per turn

Second-order resonant extraction

- An extraction can also be made over a few hundred turns
- 2nd and 4th order resonances
 - Octupole fields distort the regular phase space particle trajectories.
 - Stable area defined, delimited by two unstable Fixed Points.
 - Beam tune brought across a 2nd order resonance ($Q \rightarrow 0.5$)
 - Particle amplitudes quickly grow and beam is extracted in a few hundred turns.

Resonant extraction separatrices

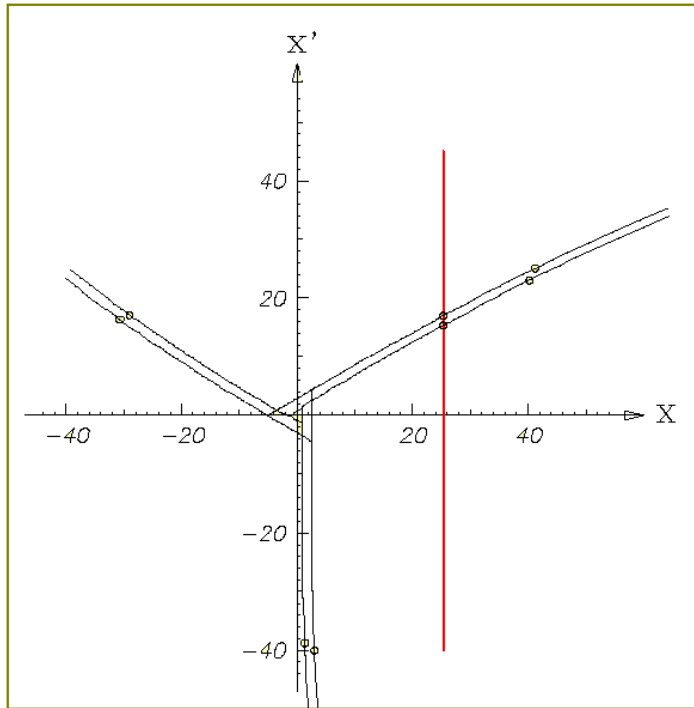

\bar{X}' 3rd order resonant extraction

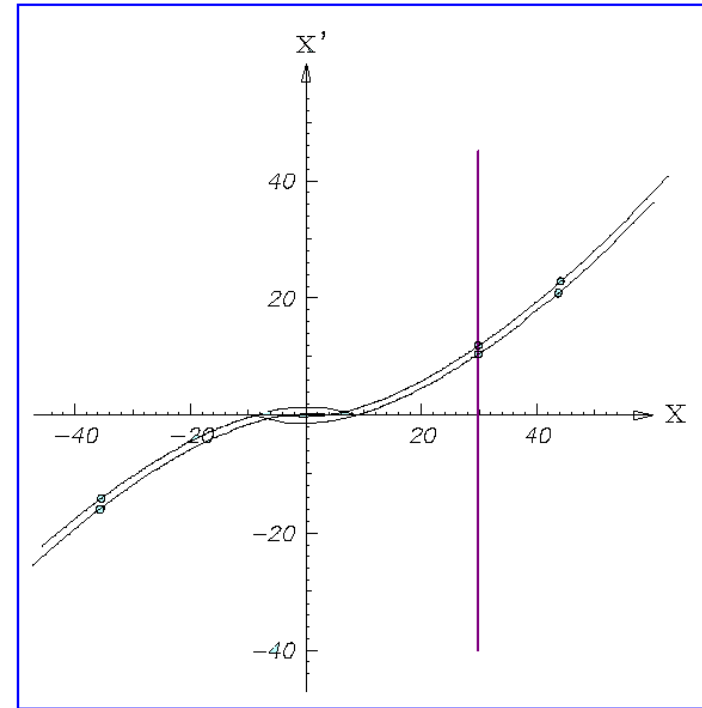
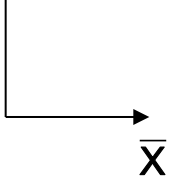

2nd order resonant extraction

- Amplitude growth for 2nd order resonance much faster than 3rd – shorter spill
- Used where intense pulses are required on target – e.g. neutrino production

Resonant low-loss multi-turn extraction

- Adiabatic capture of beam in stable “islands”
 - Use non-linear fields (sextupoles and octupoles) to create islands of stability in phase space
 - A slow (adiabatic) tune variation to cross a resonance and to drive particles into the islands (capture)
 - Variation of field strengths to separate the islands in phase space
- Several big advantages
 - Losses reduced virtually to zero (no particles at the septum)
 - Phase space matching improved with respect to existing non-resonant multi-turn extraction - all ‘beamlets’ have same emittance and optical parameters

Resonant low-loss multi-turn extraction

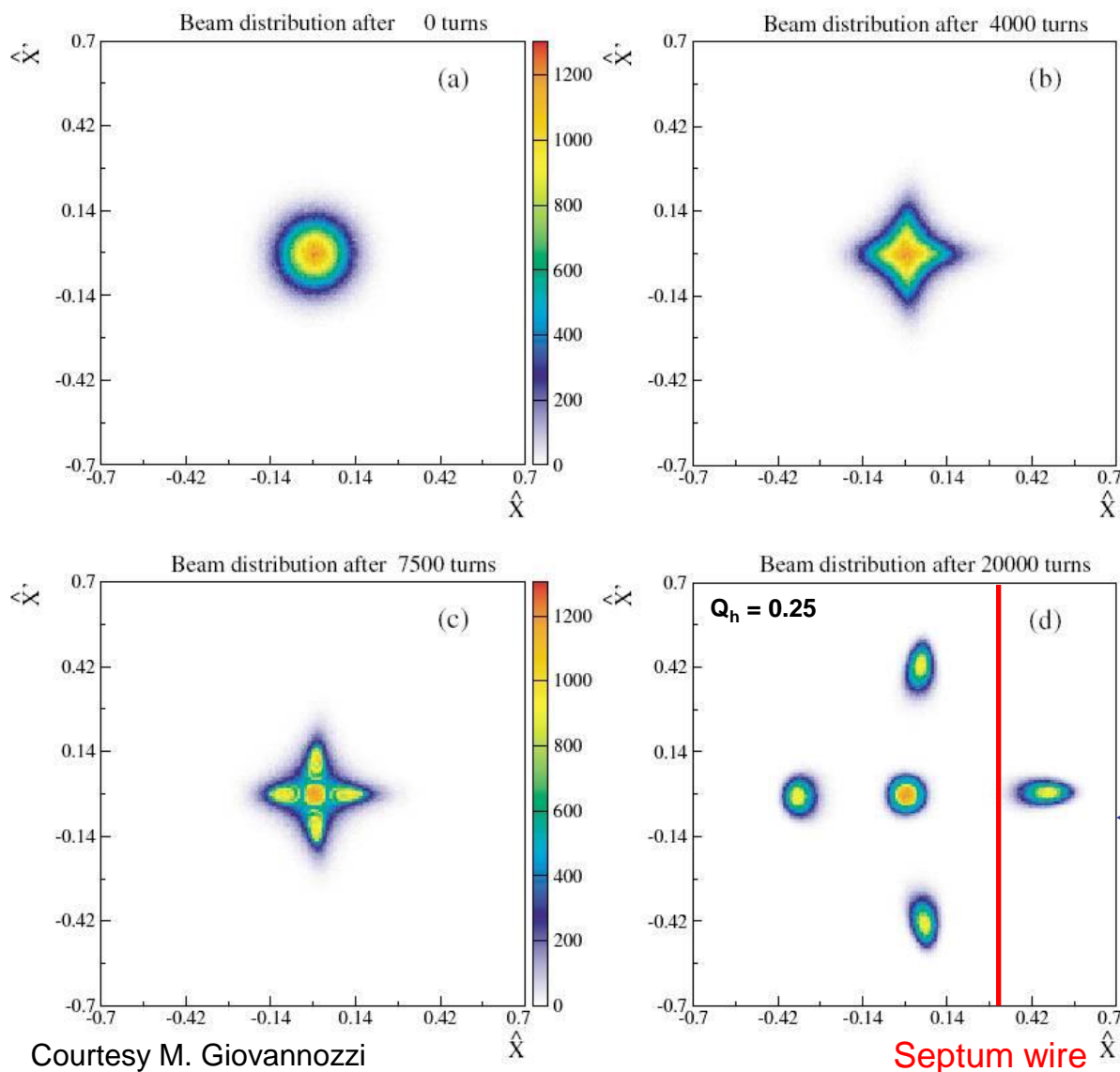

- Unperturbed beam
- Increasing non-linear fields
- Beam captured in stable islands
- Islands separated and beam bumped across septum – extracted in 5 turns

Bump vs. turn

1

2

3

4

5

Extraction - summary

- Several different techniques:
 - Single-turn fast extraction:
 - for Boxcar stacking (transfer between machines in accelerator chain), beam abort
 - Non-resonant multi-turn extraction
 - slice beam into equal parts for transfer between machine over a few turns.
 - Resonant multi-turn extraction
 - create stable area in phase space \Rightarrow slowly drive particles into resonance \Rightarrow long spill over many thousand turns.
 - Resonant low-loss multi-turn extraction
 - create stable islands in phase space: slice off over a few turns.