

Collective Effect III

G. Franchetti, GSI

CERN Accelerator – School

Budapest, 2-14 / 10 / 2016

Disclaimer: not all in this handouts will be presented

Type of fields

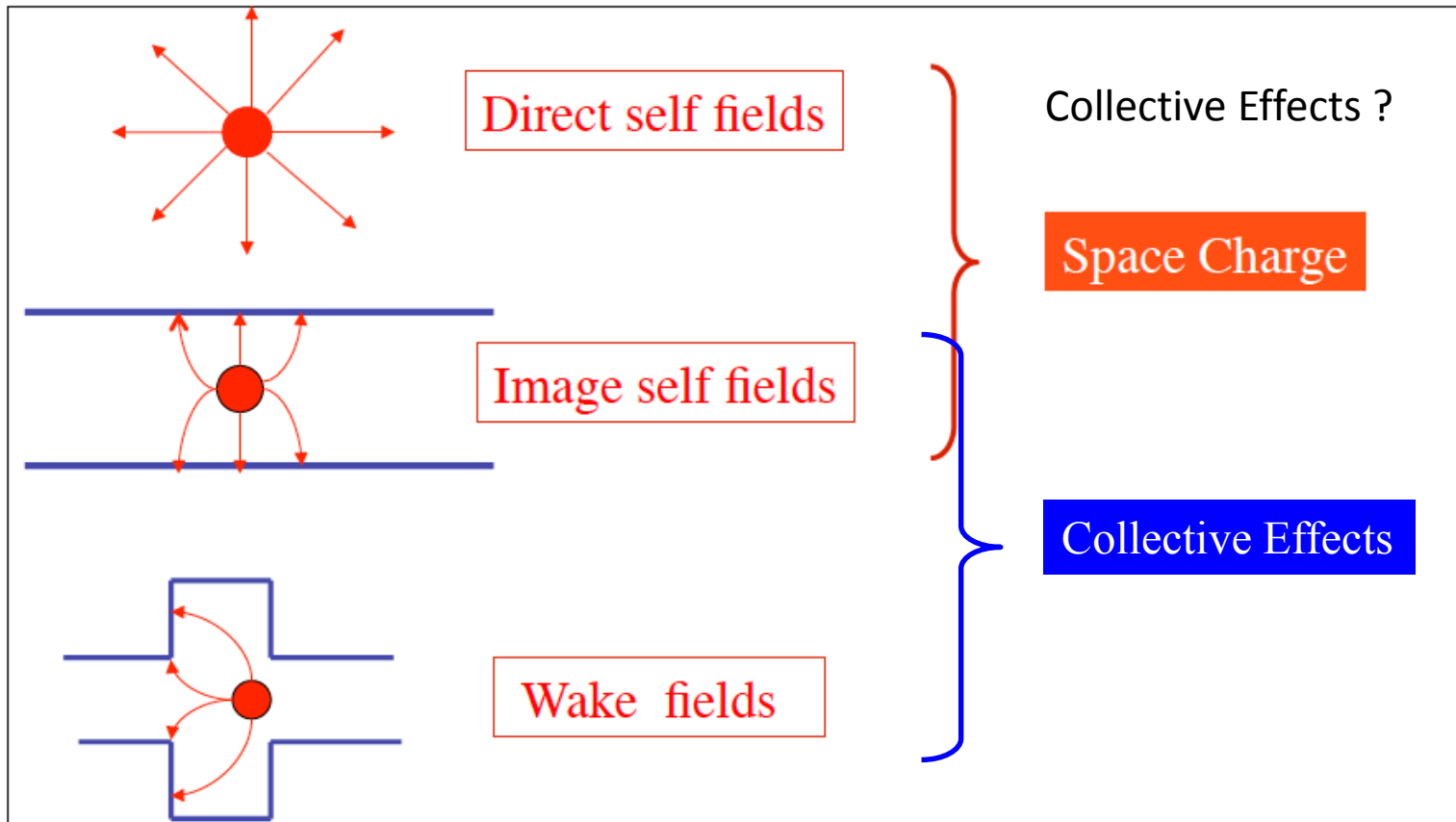

Robinson Instability

Robinson Instability

It is an instability arising from the coupling of the impedance and longitudinal motion

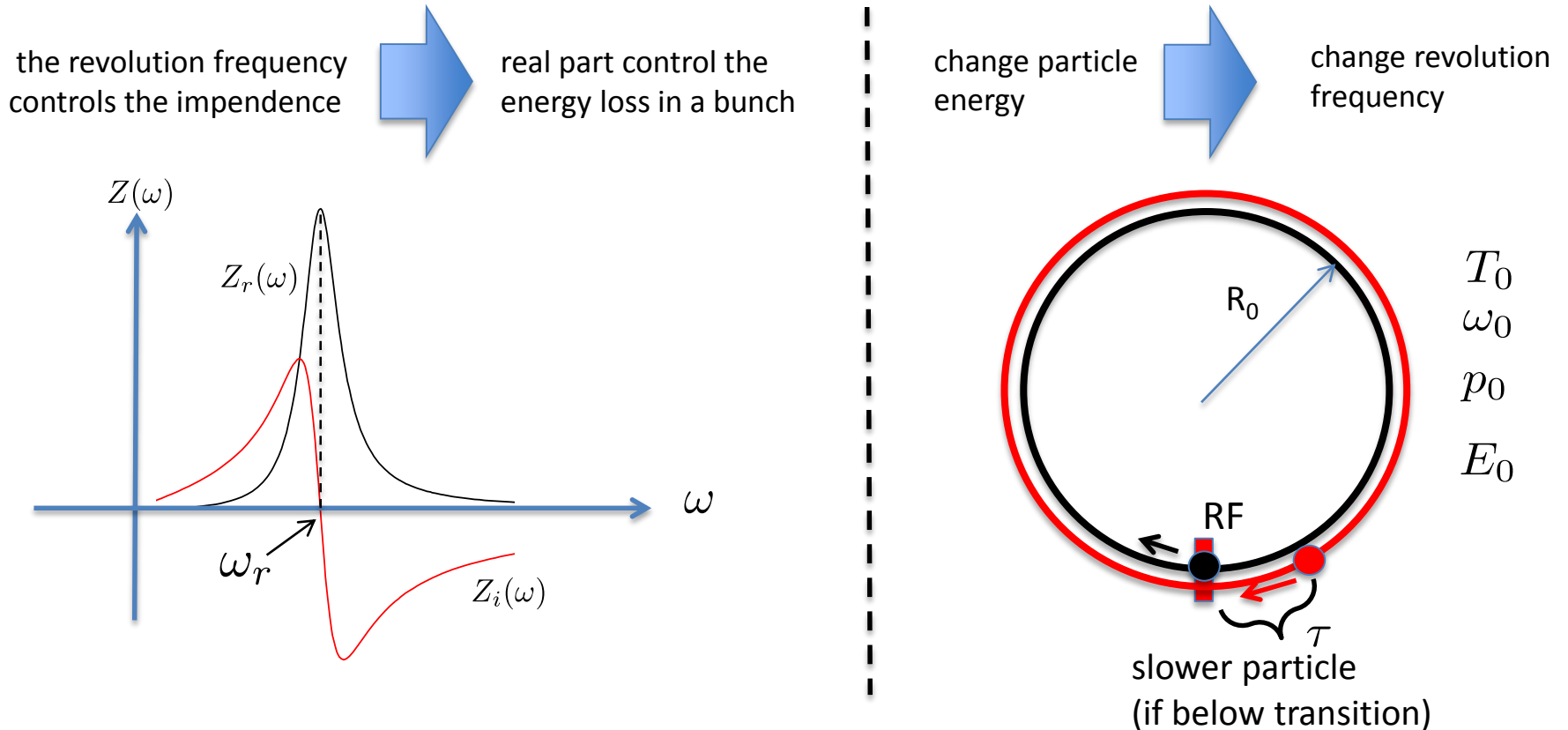

The coupling of two effects

via the longitudinal dynamics

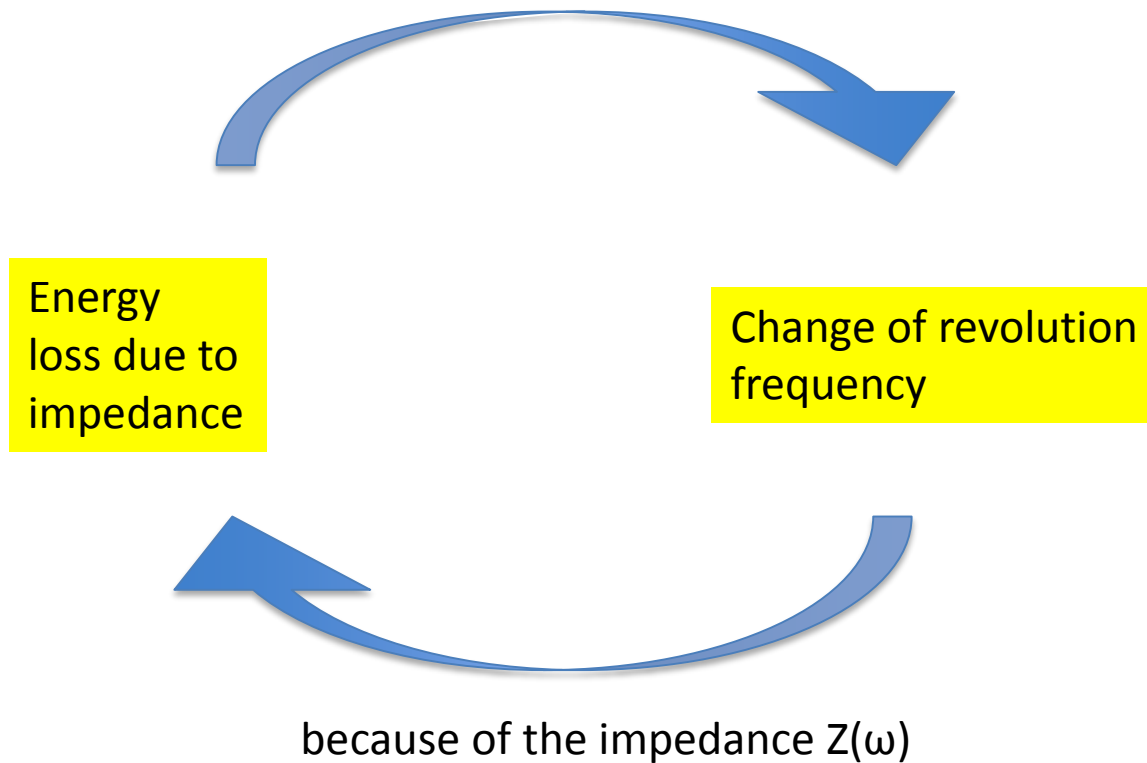

Below transition

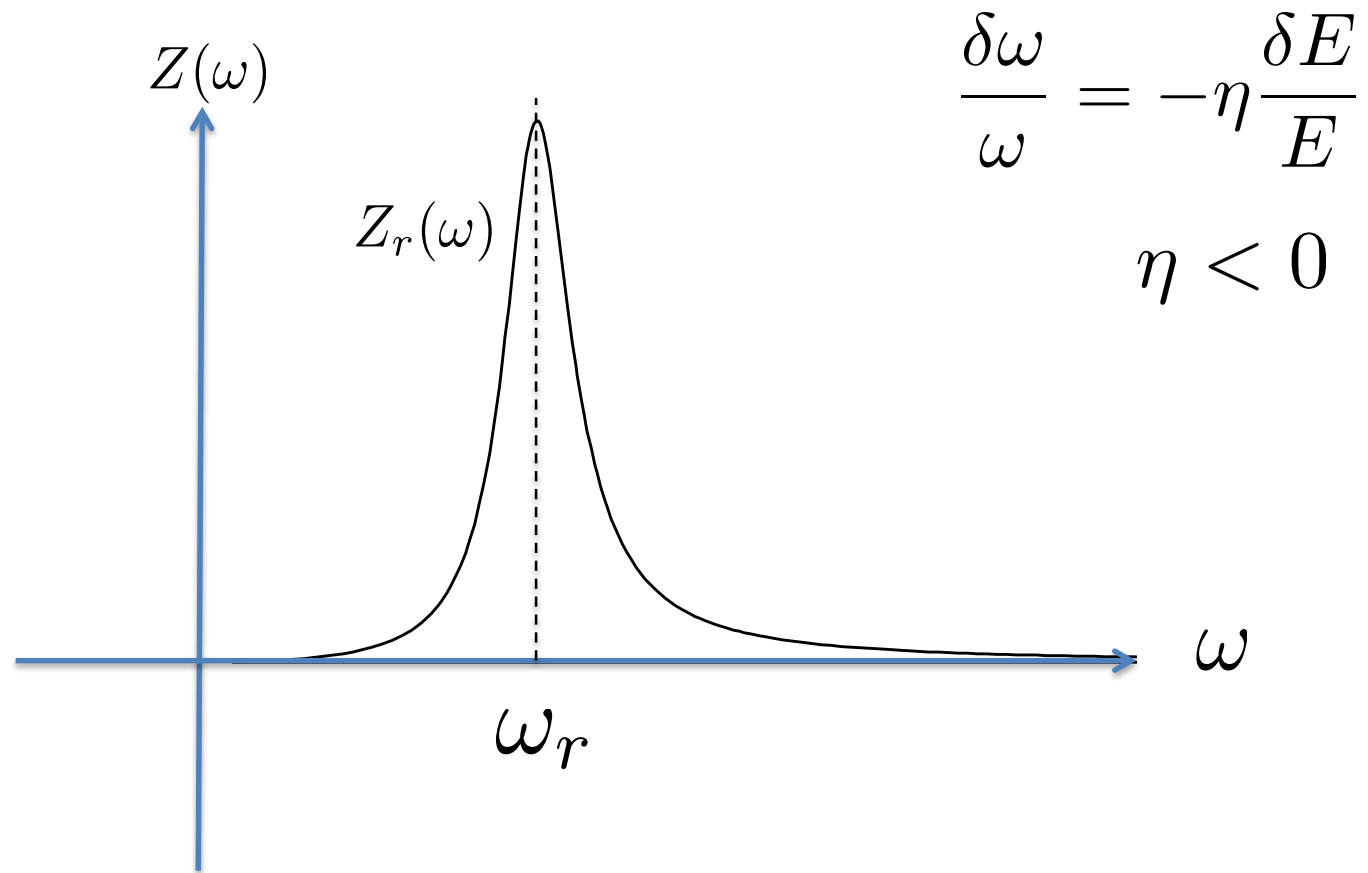

Below transition

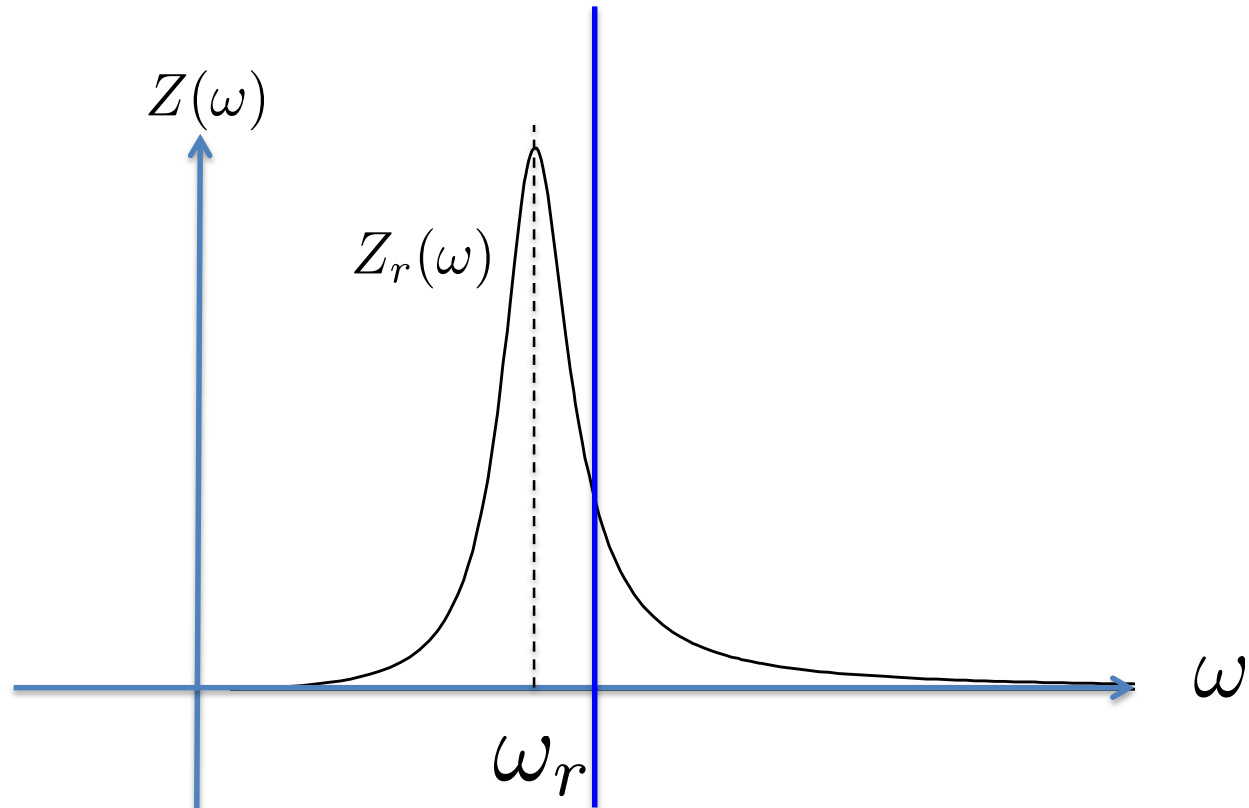

Energy lost in one turn $W_b = \int_0^{T_0} I(t)V(t)dt$

Below transition

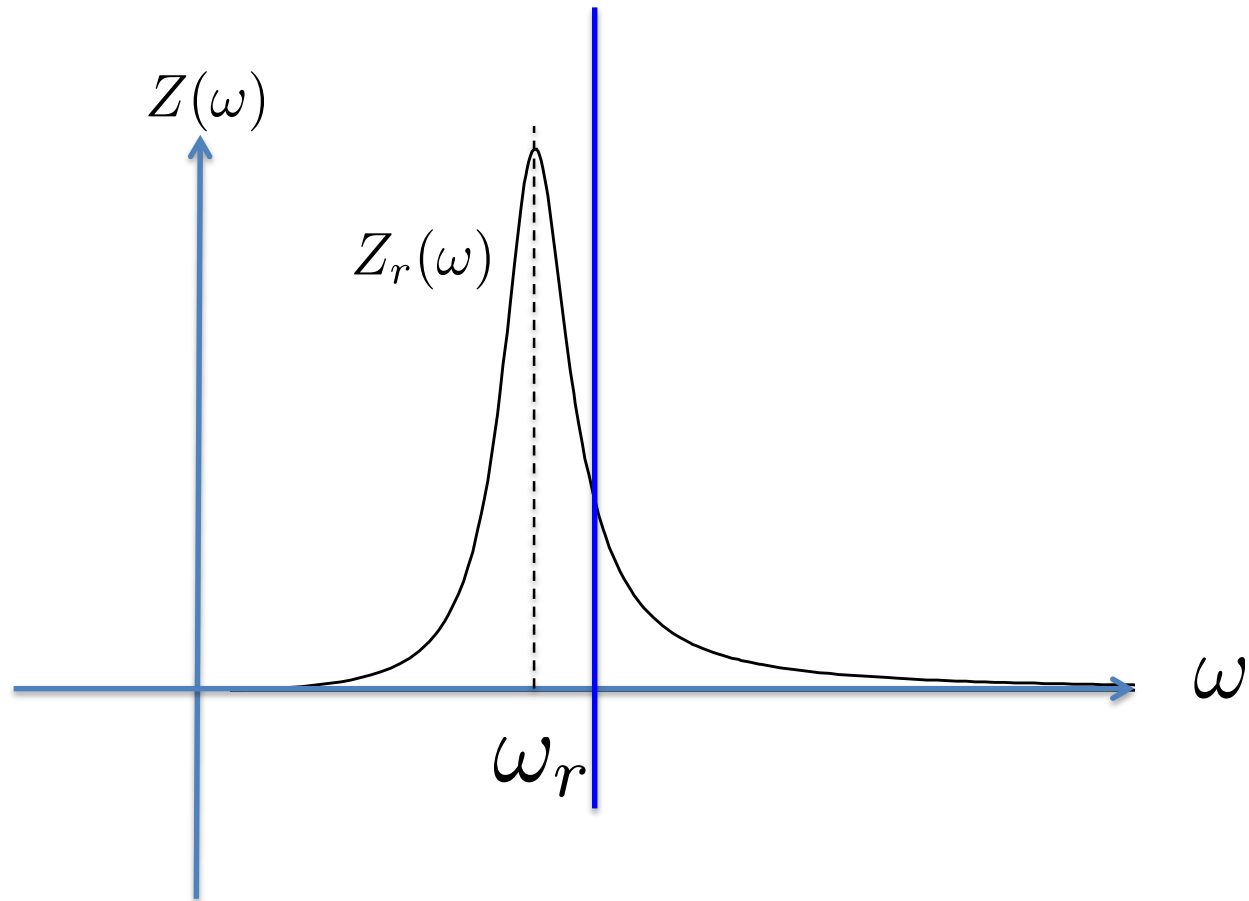

Where $V(t)$ is given by the impedance $Z_r(\omega)$

Below transition

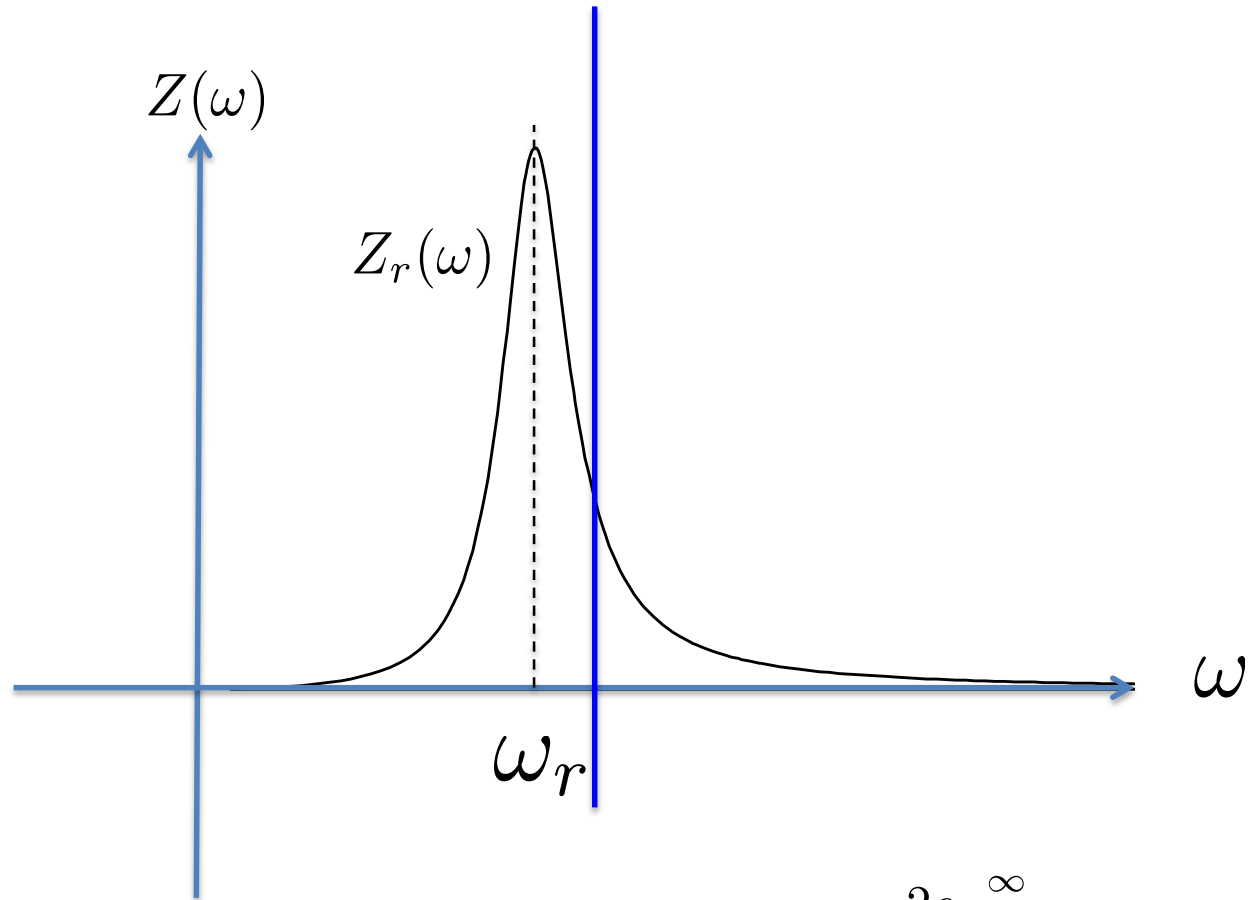

energy lost per particle for non oscillating bunch $U = \frac{2e}{I_0} \sum_1^{\infty} I_p^2 Z_r(p\omega_0)$

Below transition

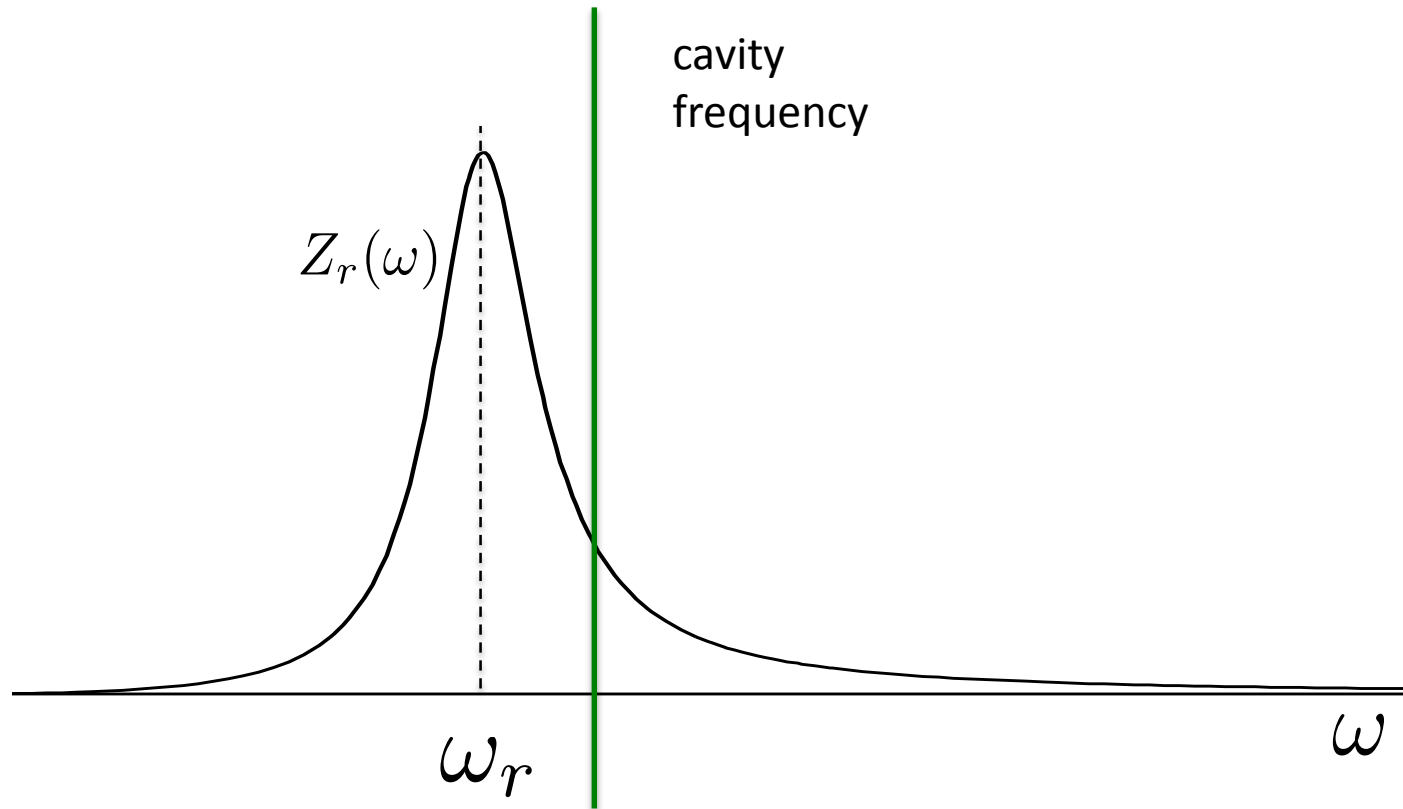

In one turn energy is lost but compensated by the RF

Below transition

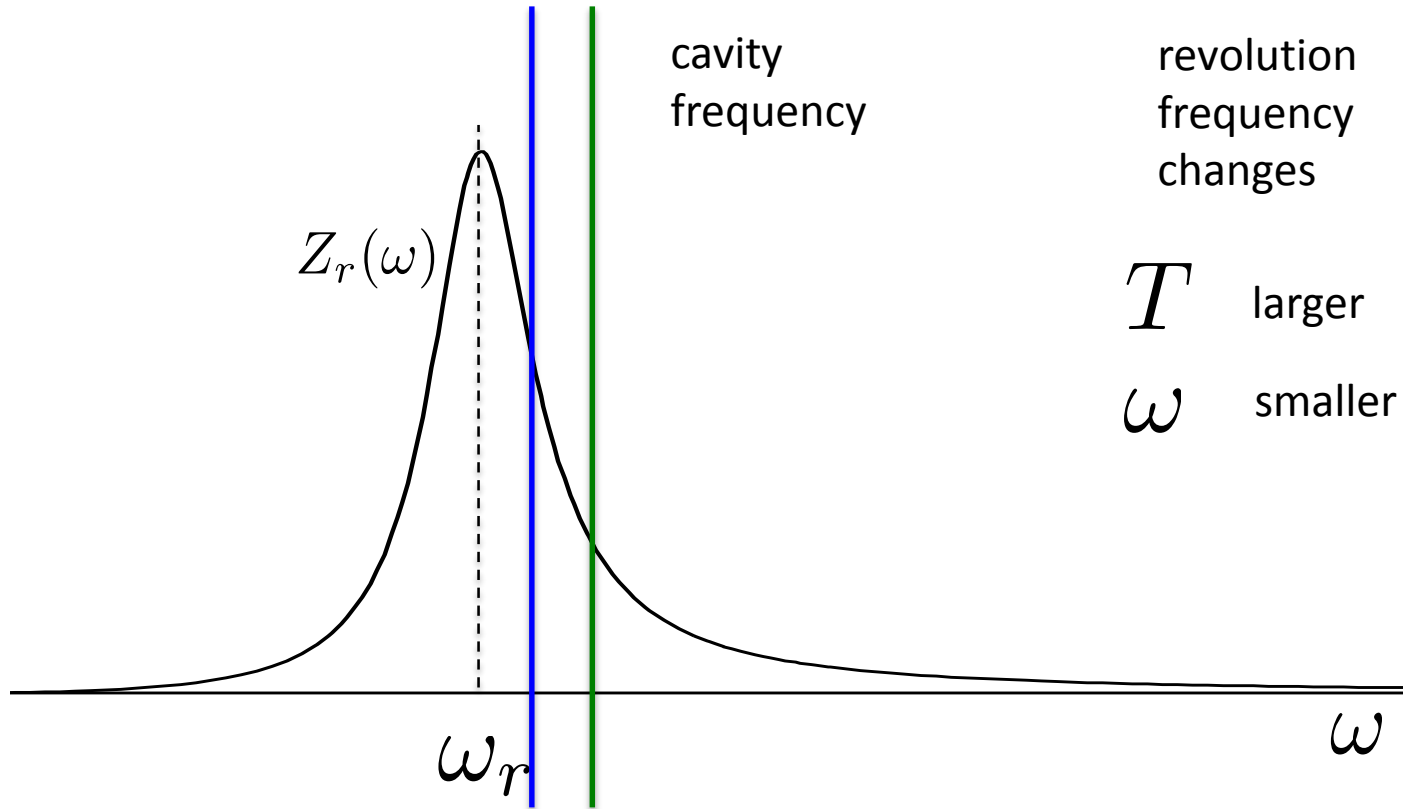

Below transition

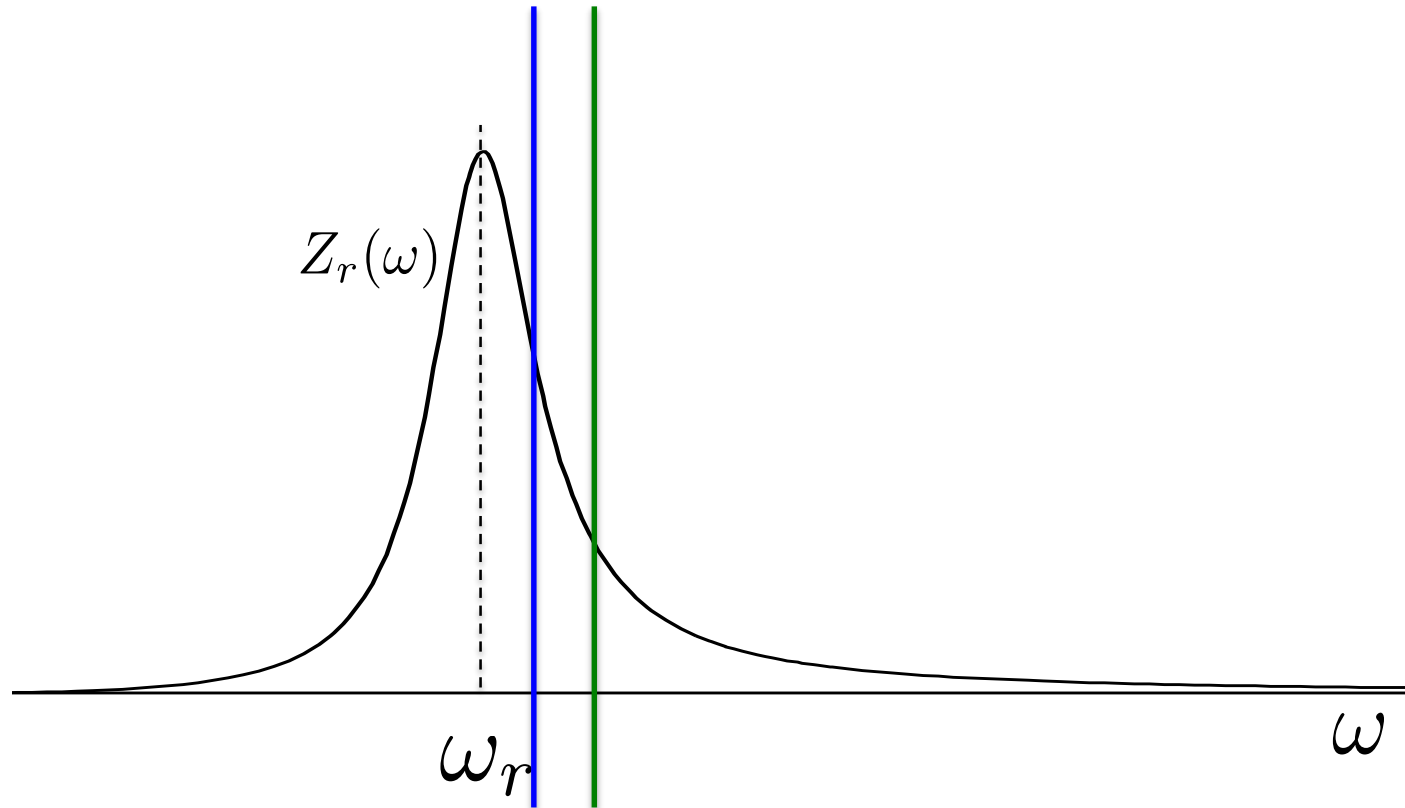

Energy lost \rightarrow decrease $\omega \rightarrow$ increase $Z_r \rightarrow$ increase energy loss !!!

Below transition

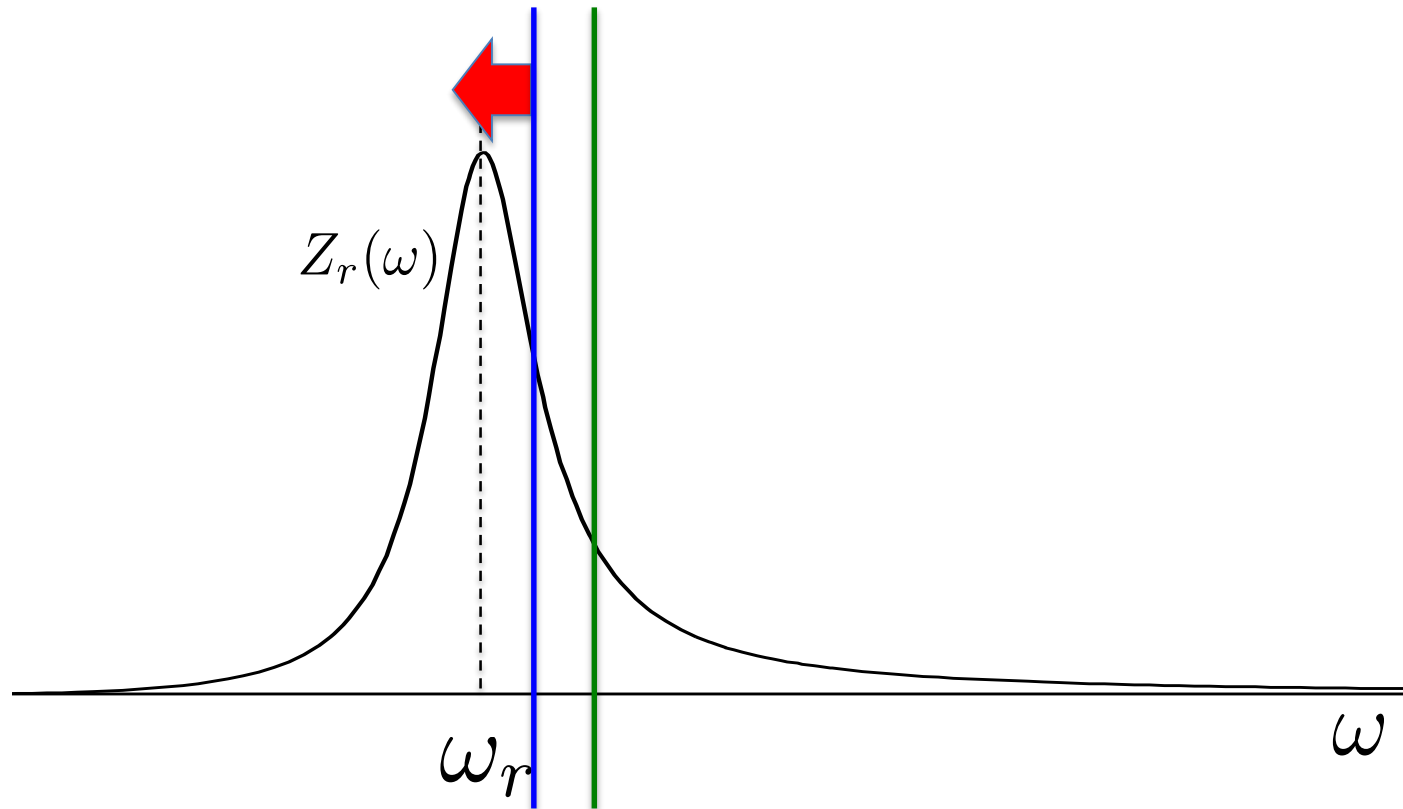

Below transition

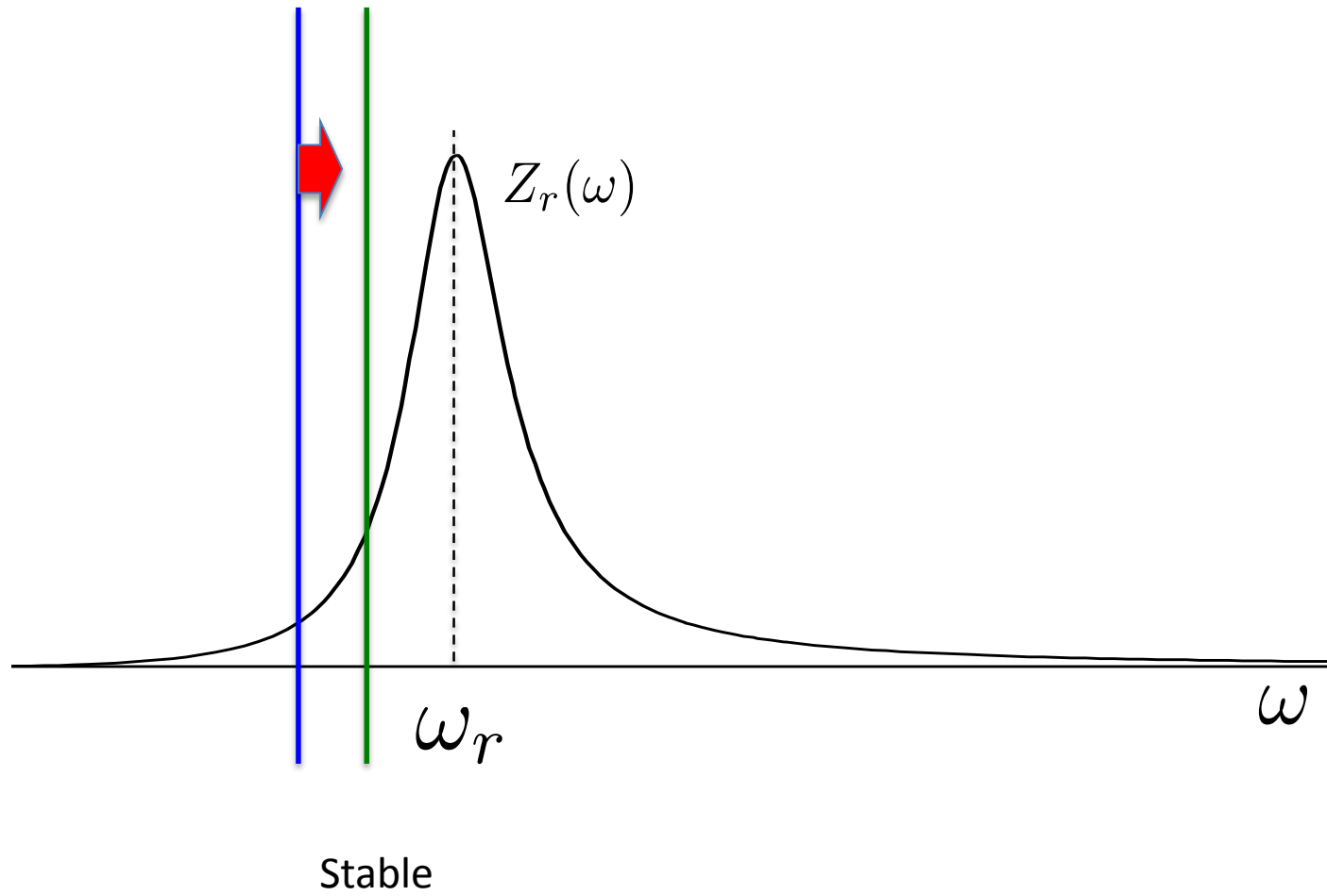

Below transition

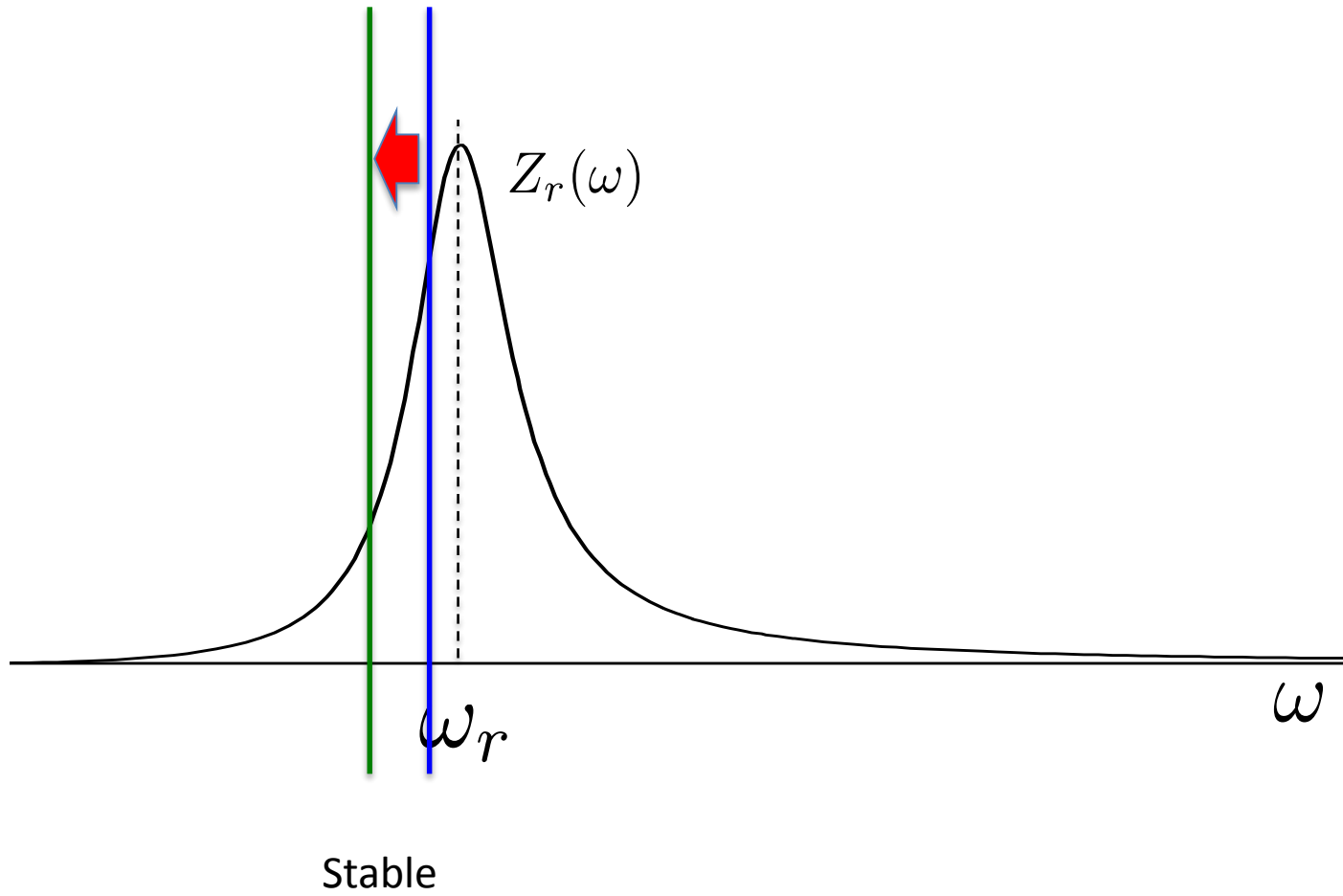

Below transition

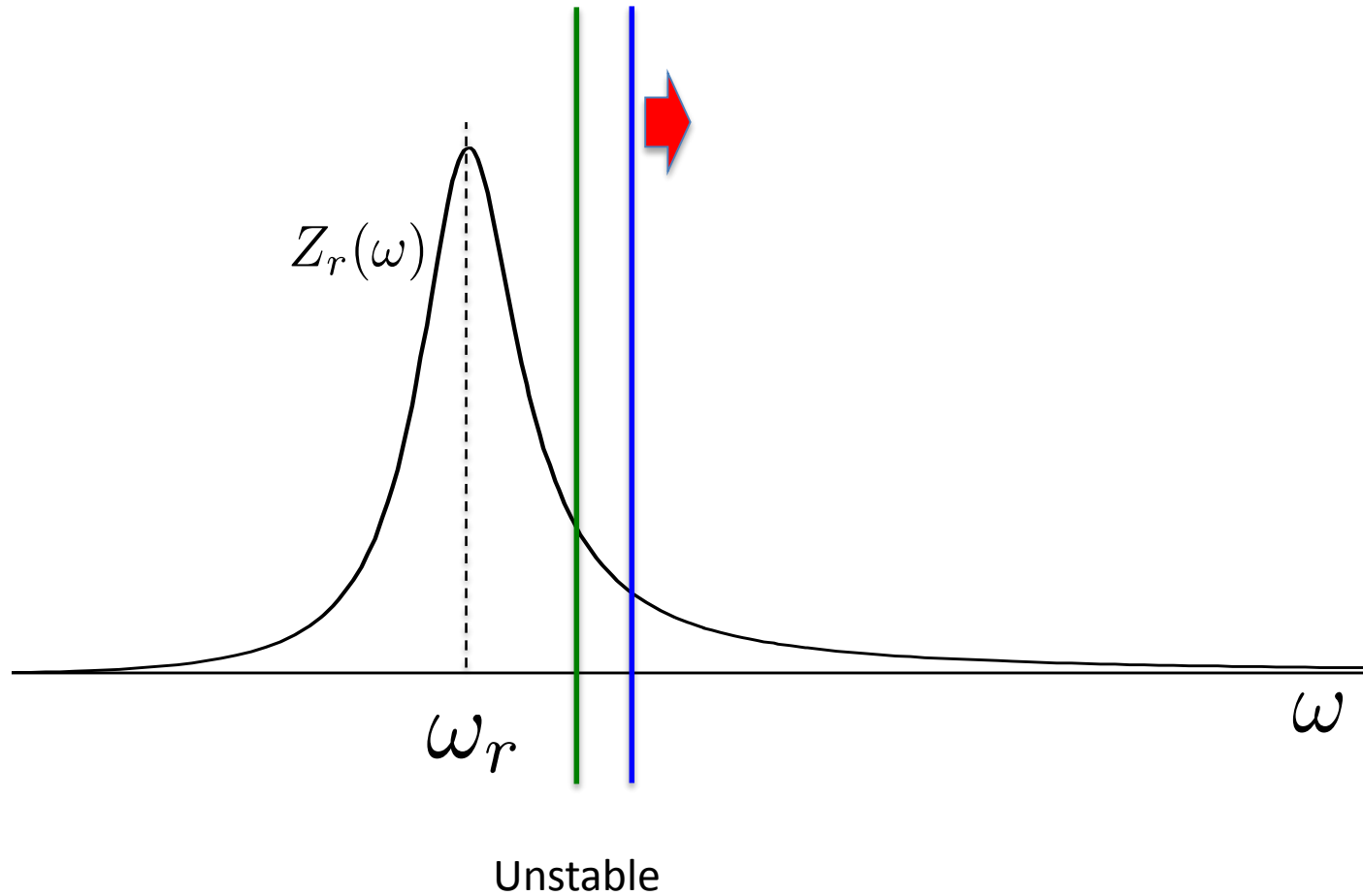

Below transition

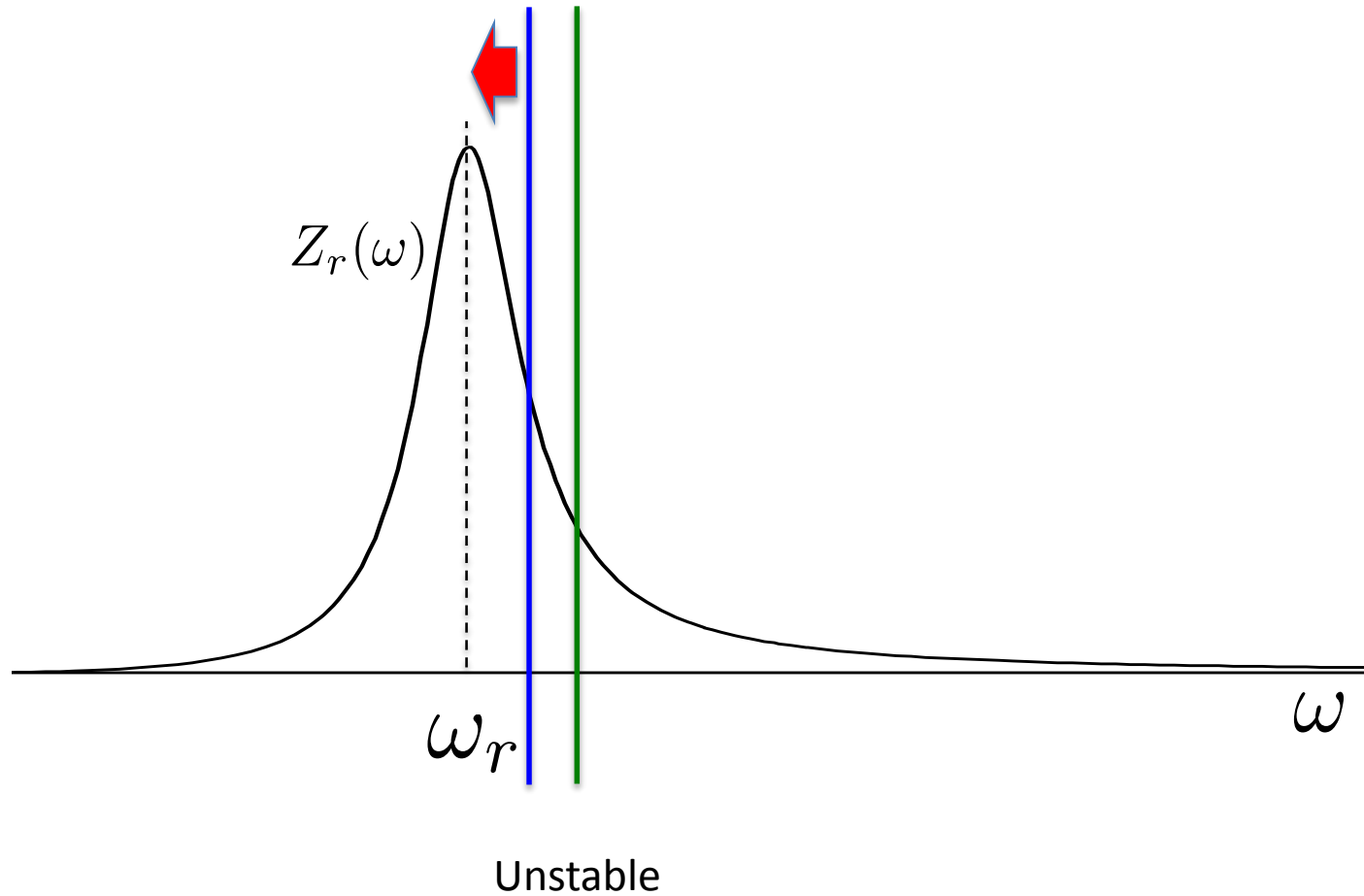

Summary of the reasoning

below transition

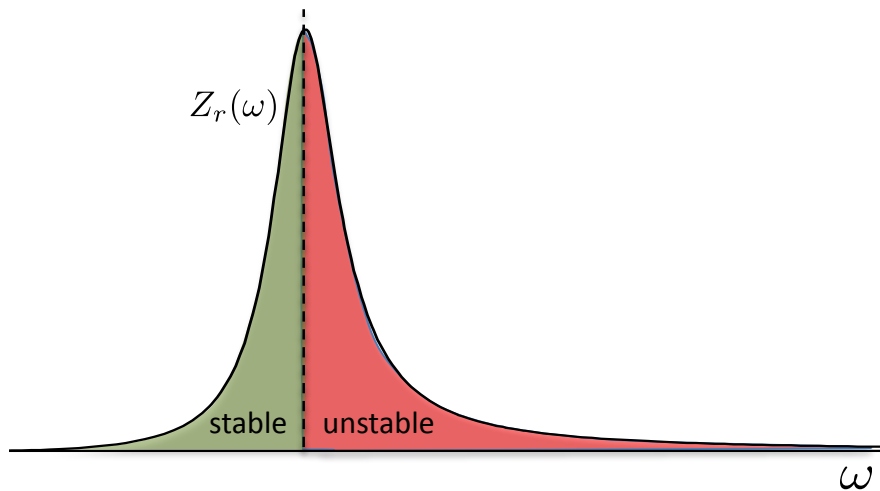

above transition

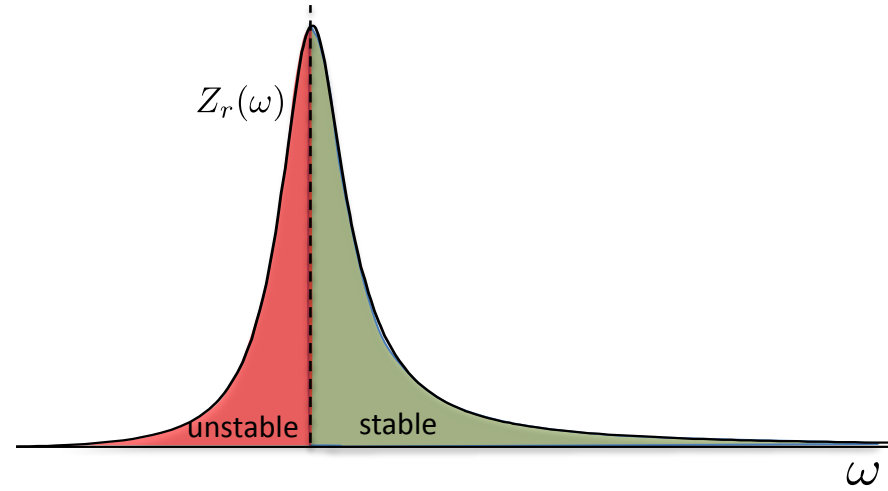

More complicated

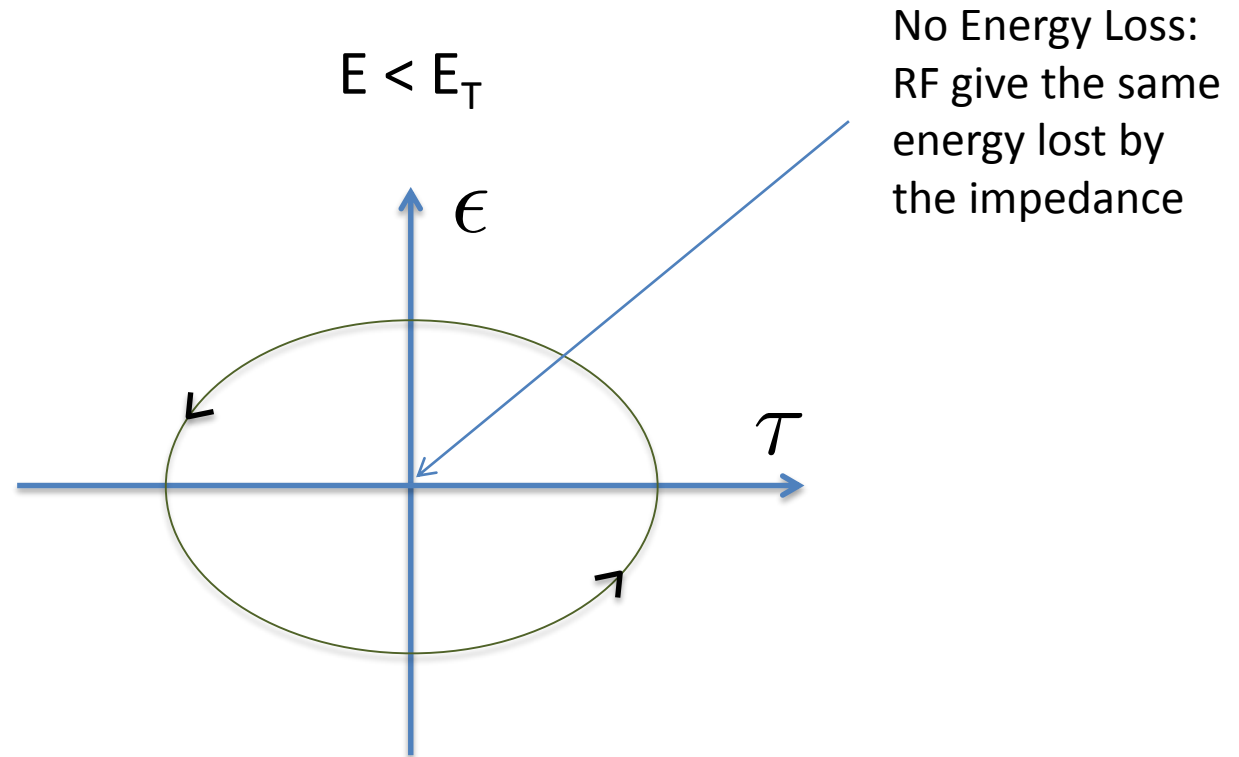

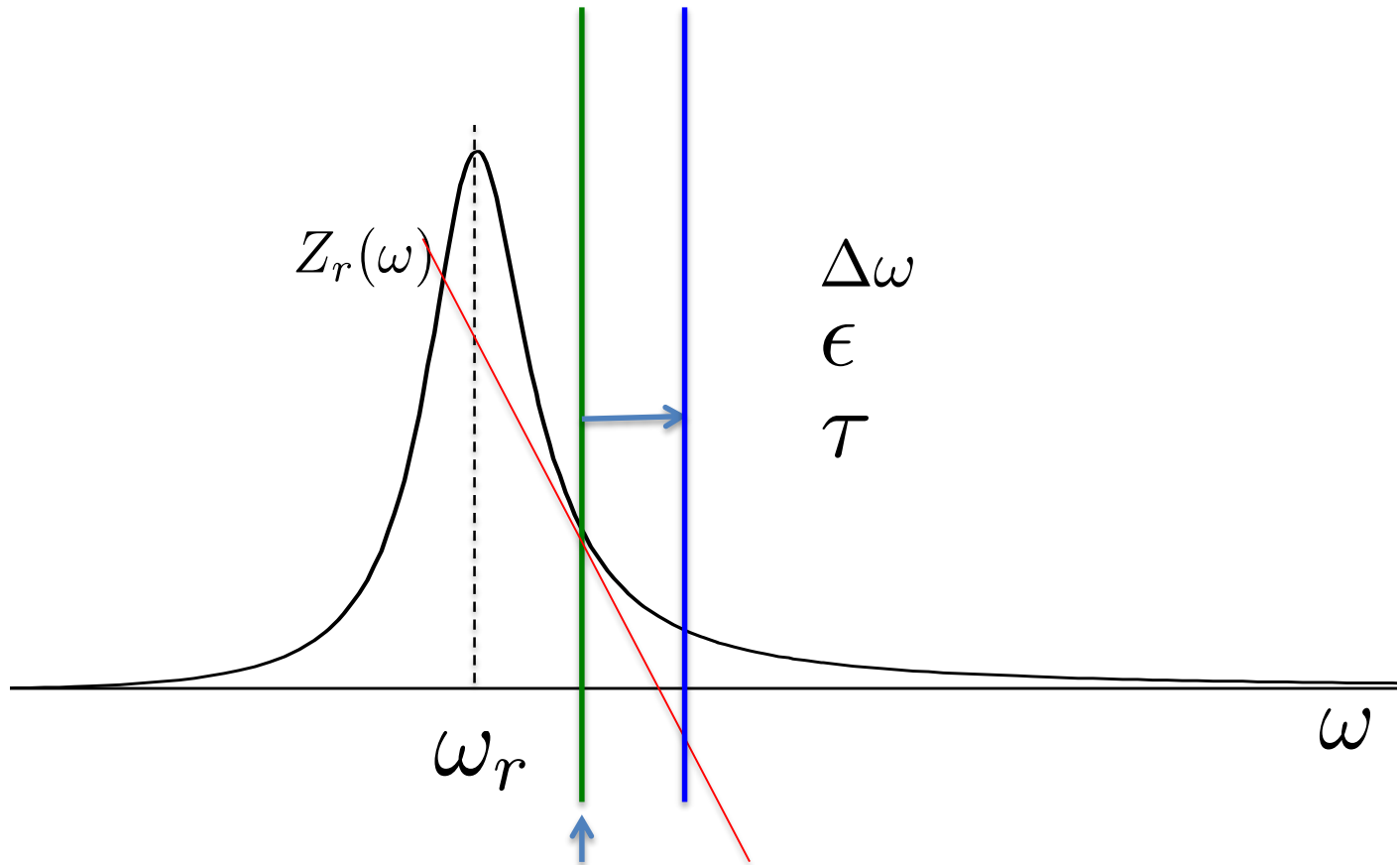

$Z_r(\omega)$

$\Delta\omega$
 ϵ
 τ

ω_r

ω

set the cavity
 frequency here

Remember that energy lost is $V \cdot I$

Source of difficulty

$$E < E_T$$

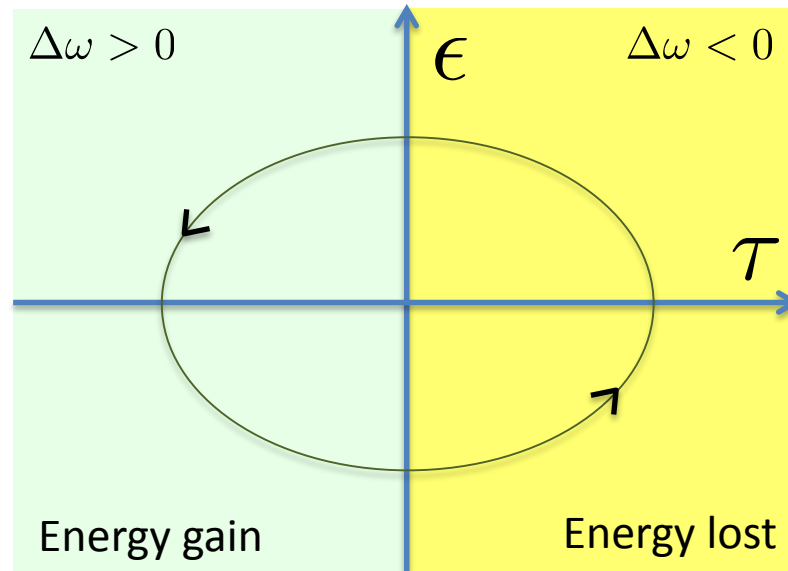

Impedance effect \rightarrow

time domain

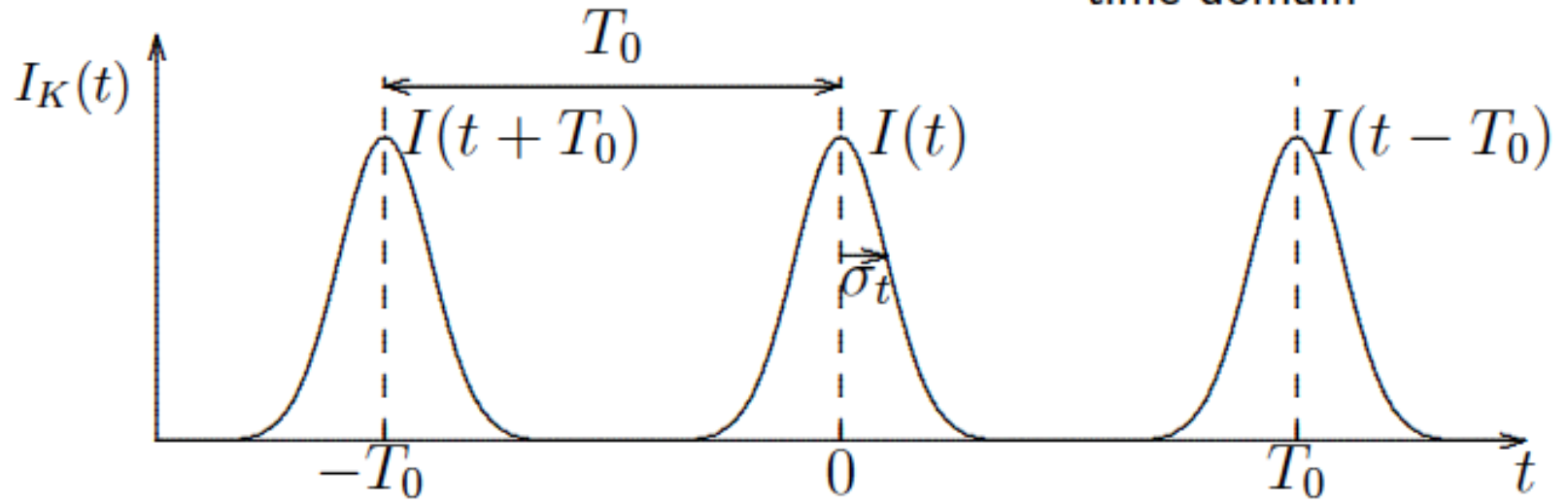

frequency domain

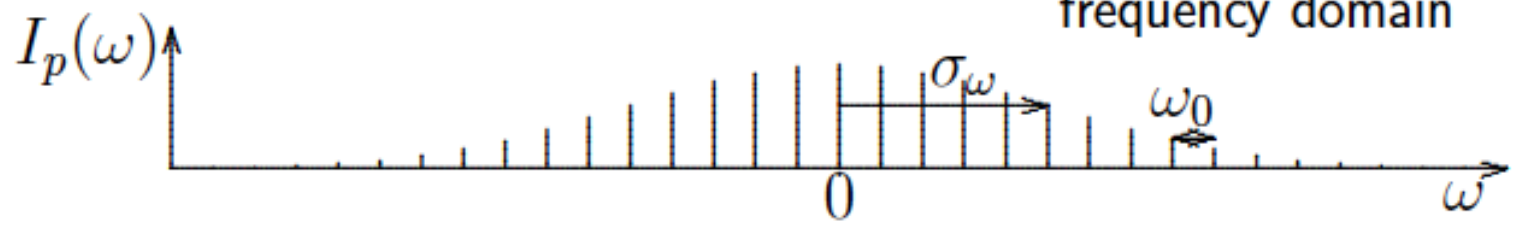

$$I_k(t) = \sum_{p=-\infty}^{\infty} I_p e^{ip\omega_0 t}$$

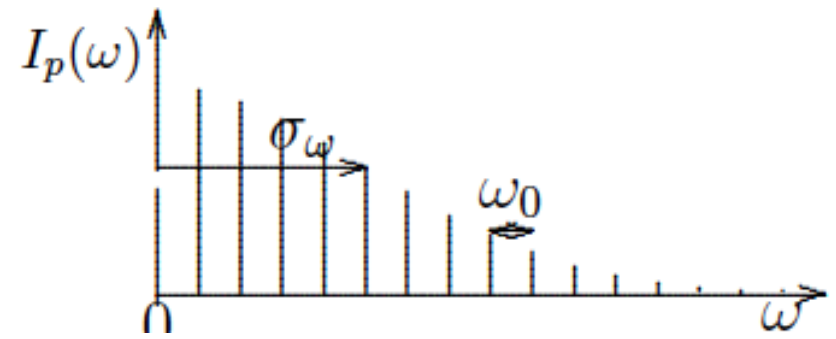

Still we neglect something

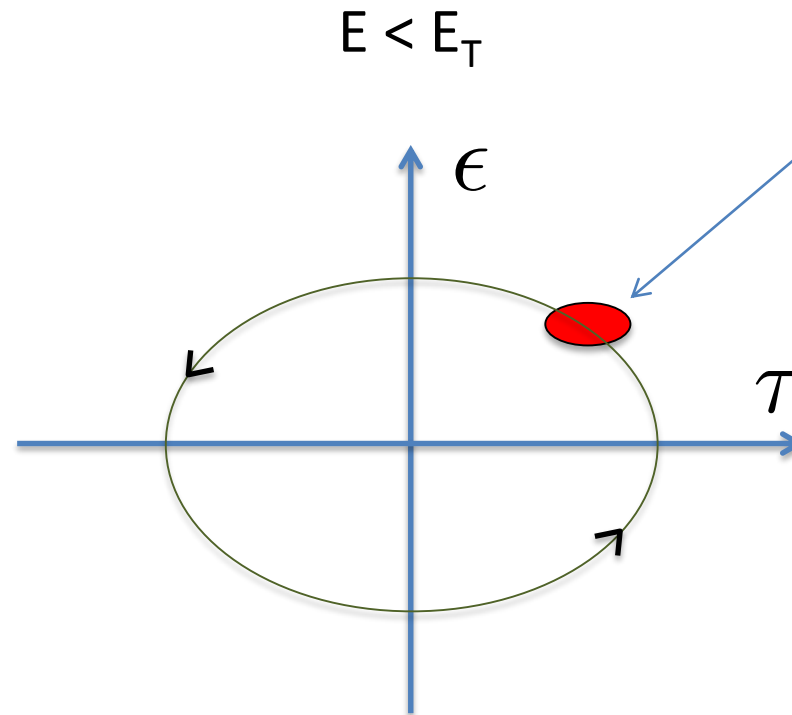

position of the bunch at
turn "k"

$$\tau_k = \hat{\tau} \cos(2\pi Q_s k)$$

Q_s is the synchrotron
tune

$$\tau_k = \hat{\tau} \cos(\omega_s t)$$

time domain

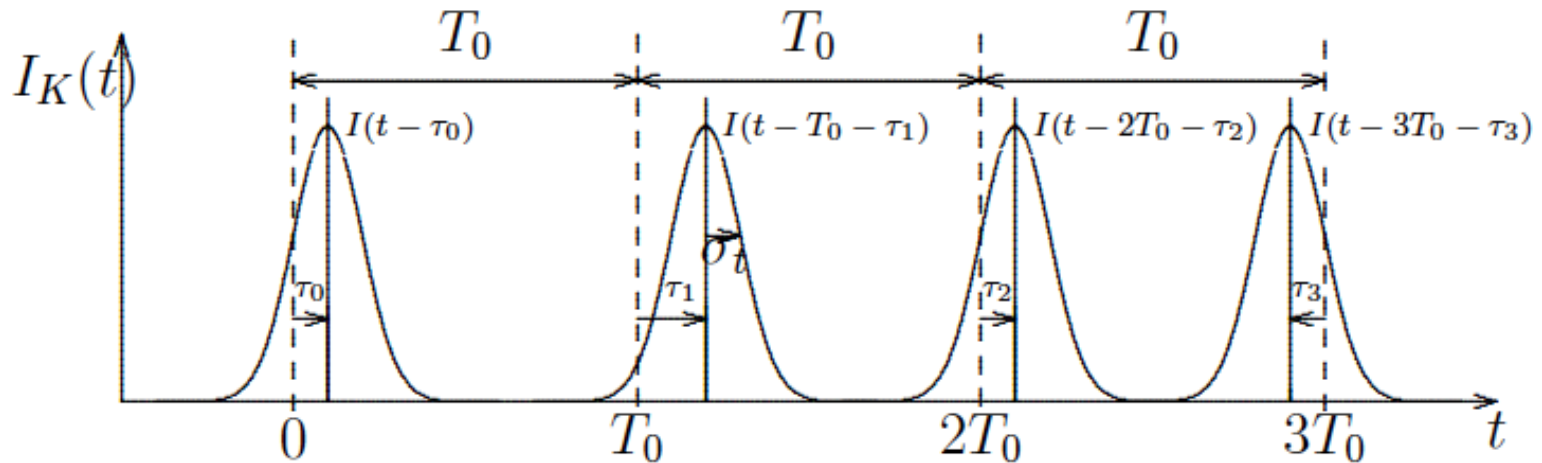

frequency domain, $\omega > 0$

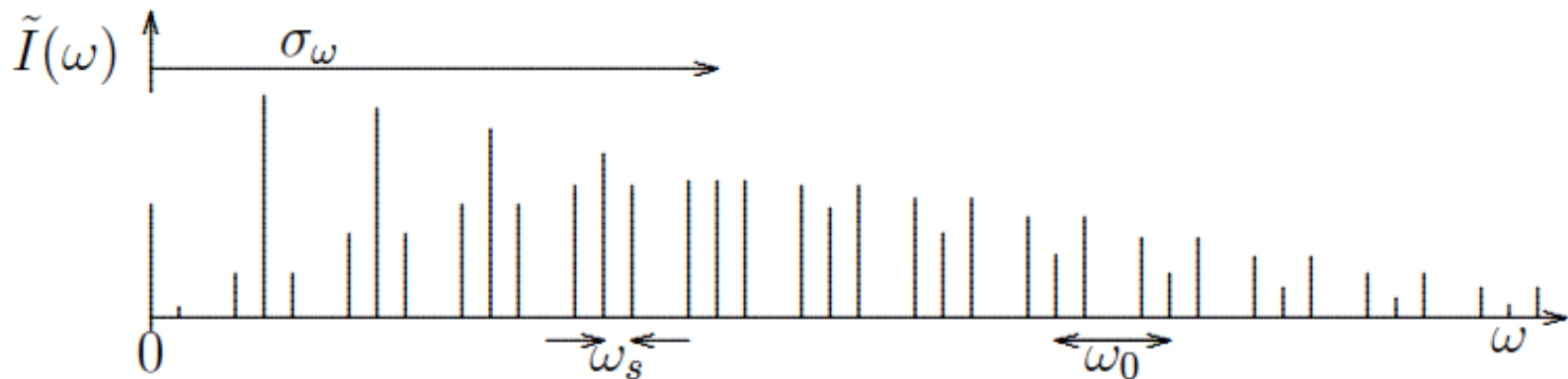

$$t \rightarrow t + \hat{\tau} \cos(\omega_s t) \quad \rightarrow \quad I_k(t) = \sum_{p=-\infty}^{\infty} I_p e^{ip\omega_0 [t + \hat{\tau} \cos(\omega_s t)]}$$

Current

$$I_k(t) \simeq 2 \sum_{\omega > 0} I_p \left[\cos(p\omega_0 t) + \frac{p\omega_0\tau}{2} \underbrace{\sin((p + Q_s)\omega_0 t)}_{\omega_p^+} + \frac{p\omega_0\tau}{2} \underbrace{\sin((p - Q_s)\omega_0 t)}_{\omega_p^-} \right]$$

The bunch current can be described by 3 components with frequency very close

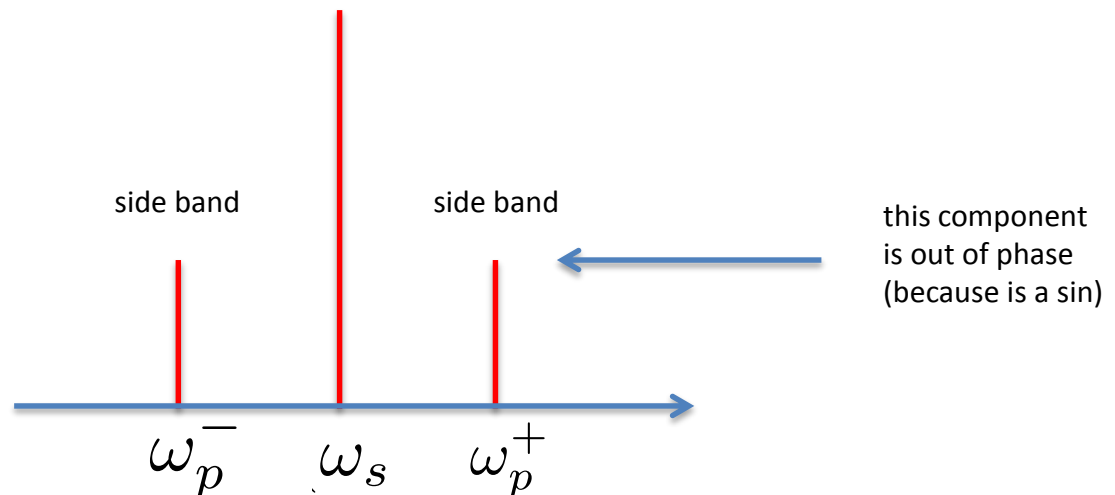

That means that the energy loss due to the impedance has to be computed on the 3 currents...

Voltage created by the resistive impedance

Main component

$$V = 2 \sum_{\omega > 0}^{\infty} I_p Z_r(p\omega_0) \cos(p\omega_0 t)$$

1st sideband

$$V = \sum_{\omega > 0}^{\infty} I_p p\omega_0 \hat{\tau} Z_r(\omega_p^+) \sin(\omega_p^+ t)$$

2nd sideband

$$V = \sum_{\omega > 0}^{\infty} I_p p\omega_0 \hat{\tau} Z_r(\omega_p^-) \sin(\omega_p^- t)$$

Prosthaphaeresis formulae

$$\sin(\omega_p^- t) = \sin(p\omega_0 t) \cos(\omega_s t) - \cos(p\omega_0 t) \sin(\omega_s t)$$

$$\sin(\omega_p^+ t) = \sin(p\omega_0 t) \cos(\omega_s t) + \cos(p\omega_0 t) \sin(\omega_s t)$$

But $\tau = \hat{\tau} \cos(\omega_s t)$



$$\left\{ \begin{array}{l} \cos(\omega_s t) = \frac{\tau}{\hat{\tau}} \\ \sin(\omega_s t) = -\frac{\dot{\tau}}{\hat{\tau}\omega_s} \end{array} \right.$$

$$\sin(\omega_p^+ t) = \sin(p\omega_0 t) \frac{\tau}{\hat{\tau}} - \cos(p\omega_0 t) \frac{\dot{\tau}}{\hat{\tau}\omega_s}$$

$$\sin(\omega_p^- t) = \sin(p\omega_0 t) \frac{\tau}{\hat{\tau}} + \cos(p\omega_0 t) \frac{\dot{\tau}}{\hat{\tau}\omega_s}$$

Voltage created by the resistive impedance

Main component

$$V = 2 \sum_{\omega > 0}^{\infty} I_p Z_r(p\omega_0) \cos(p\omega_0 t)$$

1st sideband

$$V = \sum_{\omega > 0}^{\infty} I_p p\omega_0 Z_r(\omega_p^+) [\sin(p\omega_0 t)\tau - \cos(p\omega_0 t)\frac{\dot{\tau}}{\omega_s}]$$

2nd sideband

$$V = \sum_{\omega > 0}^{\infty} I_p p\omega_0 Z_r(\omega_p^-) [\sin(p\omega_0 t)\tau + \cos(p\omega_0 t)\frac{\dot{\tau}}{\omega_s}]$$

Therefore the induced Voltage depends on $\tau, \dot{\tau}$

Energy lost in one turn

$$E_l = \int_0^{T_0} V(t)I(t)dt$$

energy lost
per particle
per turn

$$U = \frac{2e}{I_0} \left[I_p^2 Z_r(p\omega_0) - \frac{I_p^2 p \omega_0}{2} (Z_r(\omega_p^+) - Z_r(\omega_p^-)) \frac{\dot{\tau}}{\omega_s} \right]$$

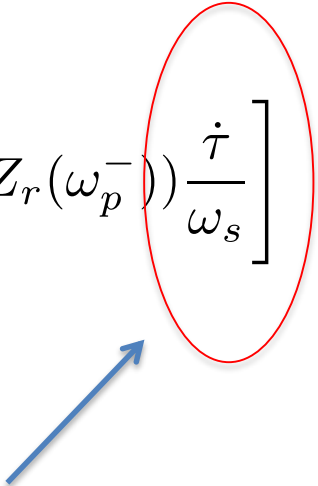

this term can give rise to
a constant loss, or a constant
gain of energy

In terms of the energy of a particle

$$U = \frac{2e}{I_0} \left[I_p^2 Z_r(p\omega_0) - \frac{I_p^2 p\omega_0}{2} (Z_r(\omega_p^+) - Z_r(\omega_p^-)) \frac{\eta\epsilon}{\omega_s} \right]$$

$$\frac{\partial U}{\partial \epsilon} = -\frac{e}{I_0} \sum_{\omega > 0} \frac{I_p^2 p\omega_0}{2} (Z_r(\omega_p^+) - Z_r(\omega_p^-)) \frac{\eta}{\omega_s}$$

This is a slope in the energy, and the sign of the slope depends on

$$Z_r(\omega_p^+) - Z_r(\omega_p^-) \quad \text{and} \quad \eta$$

The longitudinal motion now!

$$\ddot{\tau} + 2\alpha_s \dot{\tau} + \omega_{s0}^2 \tau = 0$$

$$\alpha_s = \frac{1}{2} \frac{\omega_0}{2\pi} \frac{\partial U}{\partial E} = \frac{\omega_0}{4\pi E} \frac{\partial U}{\partial \epsilon} = \frac{\omega_s \sum p I_p^2 (Z_r(\omega_p^+) - Z_r(\omega_p^-))}{2I_0 h \hat{V} \cos \phi_s}$$

Robinson Instability

- If $\alpha_s > 0$ there is a damping
- If $\alpha_s < 0$ there is an instability

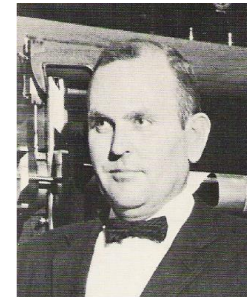

Robinson Instability

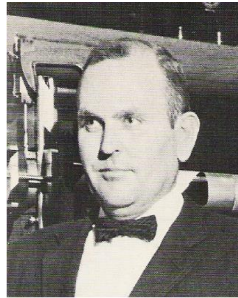

below transition

above transition

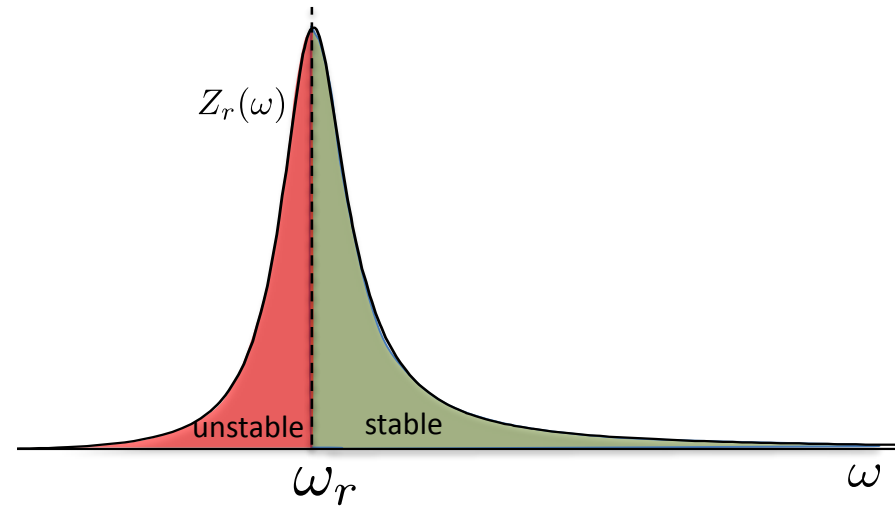
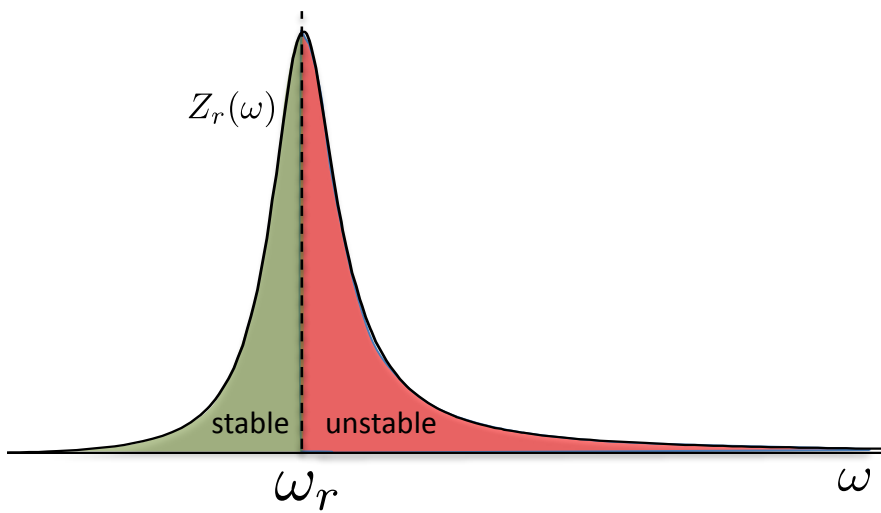

Longitudinal space charge and resistive wall impedance

Space charge longitudinal field

$$\nabla \times \vec{E} + \frac{\partial \vec{B}}{\partial t} = \vec{0}$$

$$\oint \vec{E} \cdot d\vec{l} = -\frac{\partial}{\partial t} \int \vec{B} d\vec{a}$$

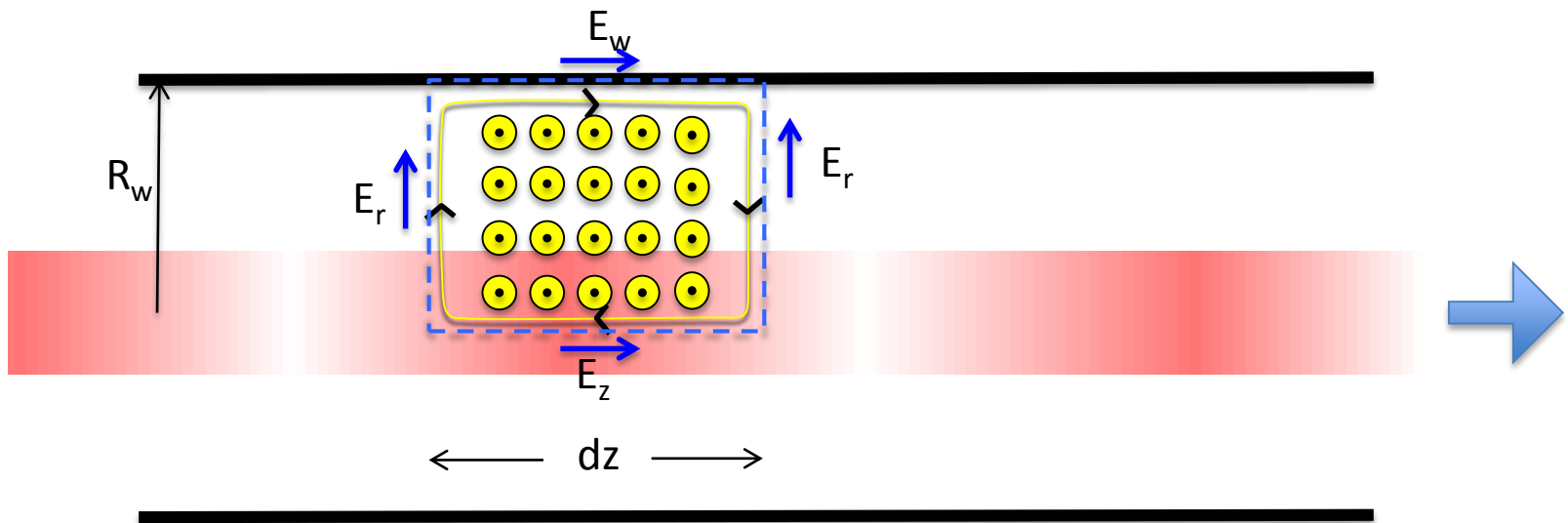

$$\oint \vec{E} \cdot d\vec{l} = \int E_r(z) dr + E_w \Delta z - \int E_r(z + \Delta z) dr - E_z \Delta z$$

For a KV beam

Electric Field

$$E_r = \begin{cases} \frac{\lambda(z)}{2\epsilon_0} r & \text{if } r < r_0 \\ \frac{\lambda(z)r_0^2}{2\epsilon_0} \frac{1}{r} & \text{if } r > r_0 \end{cases}$$

$$\int_0^{r_w} E_r(z) dr = \int_0^{r_0} \frac{\lambda(z)}{2\epsilon_0} r dr + \int_{r_0}^{r_w} \frac{\lambda(z)r_0^2}{2\epsilon_0} \frac{1}{r} dr$$



$$\int_0^{r_w} E_r(z) dr = \frac{\lambda(z)r_0^2}{4\epsilon_0} \left[1 + 2 \ln \left(\frac{r_w}{r_0} \right) \right]$$

Therefore

$$\int E_r(z) dr - \int E_r(z + \Delta z) dr = -\frac{r_0^2}{4\epsilon_0} \left[1 + 2 \ln \left(\frac{r_w}{r_0} \right) \right] \frac{\partial \lambda(z)}{\partial z} \Delta z$$



$$\oint \vec{E} \cdot d\vec{l} = (E_w - E_z) \Delta z - \frac{r_0^2}{4\epsilon_0} \left[1 + 2 \ln \left(\frac{r_w}{r_0} \right) \right] \frac{\partial \lambda(z)}{\partial z} \Delta z$$

Magnetic Field

$$B_{\perp} = \begin{cases} \frac{\mu_0 v_z \lambda(z)}{2} r & \text{if } r < r_0 \\ \frac{\mu_0 v_z \lambda(z) r_0^2}{2} \frac{1}{r} & \text{if } r > r_0 \end{cases}$$

$$\int B_{\perp} da = \int_0^{r_0} dr \int_z^{z+\Delta z} dz \frac{\mu_0 v_z \lambda(z)}{2} r + \int_{r_0}^{r_w} dr \int_z^{z+\Delta z} dz \frac{\mu_0 v_z \lambda(z) r_0^2}{2} \frac{1}{r}$$

$$\int B_{\perp} da = \frac{\mu_0 v_z r_0^2 \lambda \Delta z}{4} \left[1 + 2 \ln \left(\frac{r_w}{r_0} \right) \right]$$

Maxwell-Faraday
Law

$$\oint \vec{E} \cdot d\vec{l} = -\frac{\partial}{\partial t} \int \vec{B} d\vec{a}$$



$$(E_w - E_z)\Delta z - \frac{r_0^2}{4\epsilon_0} \left[1 + 2 \ln \left(\frac{r_w}{r_0} \right) \right] \frac{\partial \lambda(z)}{\partial z} \Delta z = + \frac{\mu_0 v_z r_0^2 \Delta z}{4} \left[1 + 2 \ln \left(\frac{r_w}{r_0} \right) \right] \frac{\partial \lambda}{\partial t}$$

from the equation of continuity $\frac{\partial \lambda}{\partial t} + v_z \frac{\partial \lambda}{\partial z} = 0$

$$E_z = E_w - \frac{r_0^2}{4\epsilon_0} \left[1 + 2 \ln \left(\frac{r_w}{r_0} \right) \right] \frac{1}{\gamma^2} \frac{\partial \lambda}{\partial z}$$



again we find the factor $1/\gamma^2$!

Space charge impedance

$$\lambda(\theta, t) = \sum_n \lambda_n e^{i(n\theta - \omega_n t)} \quad \theta = 2\pi \frac{z}{L}$$
$$\omega_n = n\omega_0$$

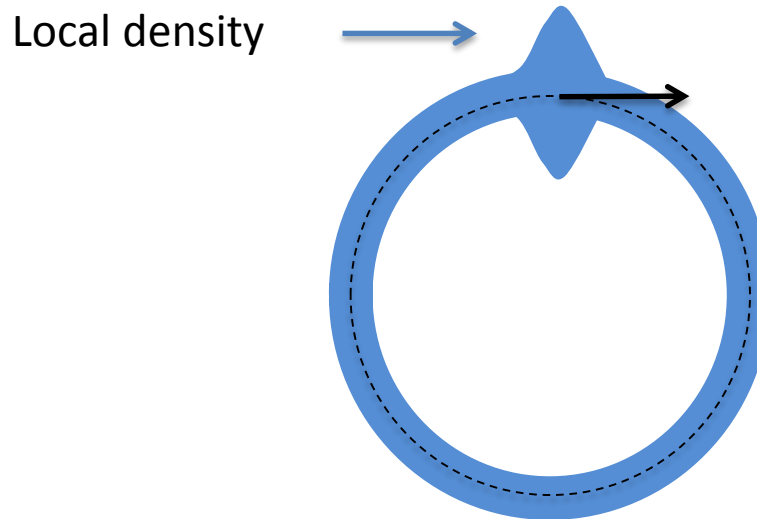

$$V_{z0} = 2\pi R E_{zw} - i \sum_n \frac{I_n}{4\pi\epsilon_0} \frac{2\pi n}{\beta c \gamma^2} \left[1 + 2 \ln \left(\frac{r_w}{r_0} \right) \right] e^{i(n\theta - \omega_n t)}$$

Perfect vacuum chamber $E_{zw} = 0$

$$I = I_n e^{i(n\theta - \omega_n t)} \quad \Rightarrow \quad V = -i \frac{I_n}{4\pi\epsilon_0} \frac{2\pi n}{\beta c \gamma^2} \left[1 + 2 \ln \left(\frac{r_w}{r_0} \right) \right] e^{i(n\theta - \omega_n t)}$$

$$Z_{||sc} = \frac{\hat{V}}{\hat{I}} \quad \Rightarrow \quad Z_{||sc} = -i \frac{1}{\epsilon_0 c} \frac{n}{2\beta \gamma^2} \left[1 + 2 \ln \left(\frac{r_w}{r_0} \right) \right]$$

Resistive Wall impedance

Do not take into account B

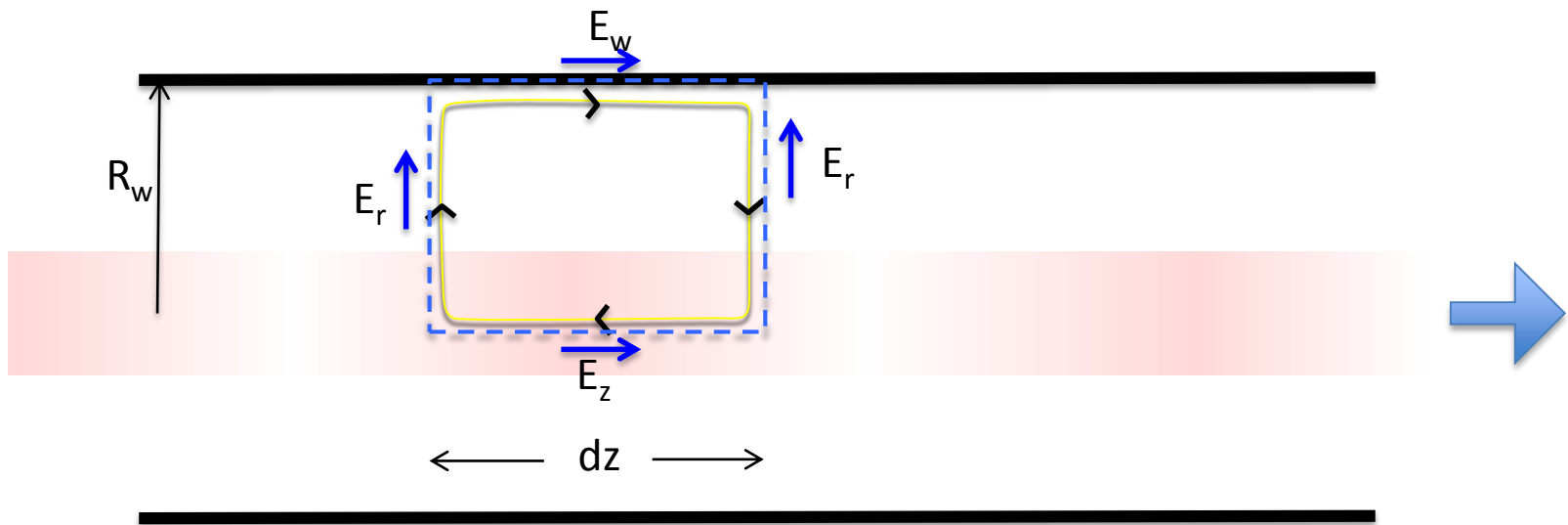

$$E_w = E_z$$

Beam on axis

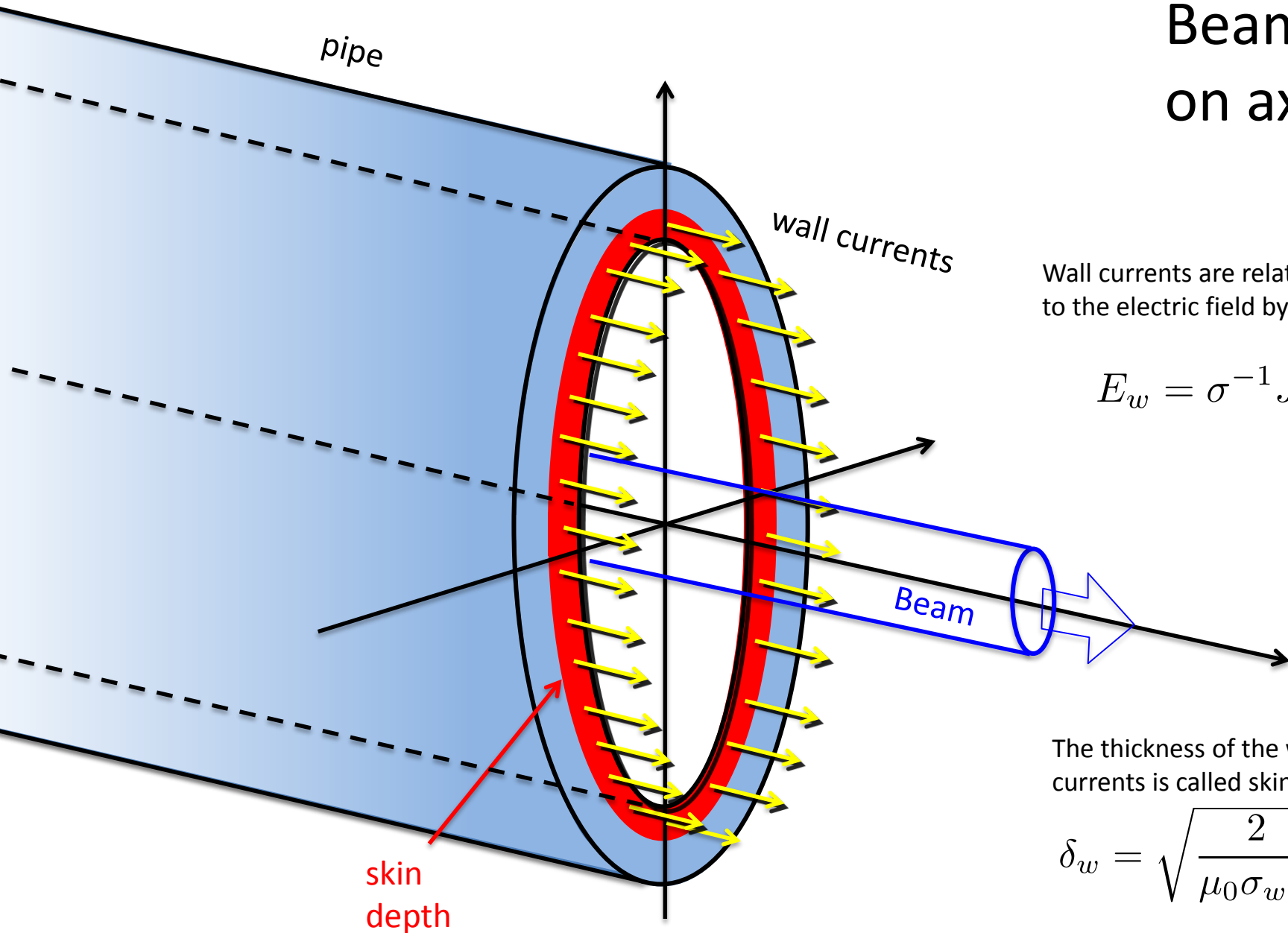

Wall currents are related to the electric field by Ohm' law

$$E_w = \sigma^{-1} J_w$$

The thickness of the wall currents is called skin depth

$$\delta_w = \sqrt{\frac{2}{\mu_0 \sigma_w \omega}}$$

Impedance of the surface (pipe)

$$Z_{surf} = \frac{1 + i}{\sigma \delta_w}$$

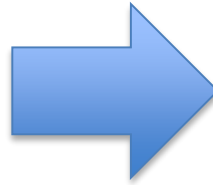

Longitudinal impedance (beam)

$$Z_{||} = \frac{2\pi R}{2\pi r_p} \frac{1 + i}{\sigma \delta_w}$$

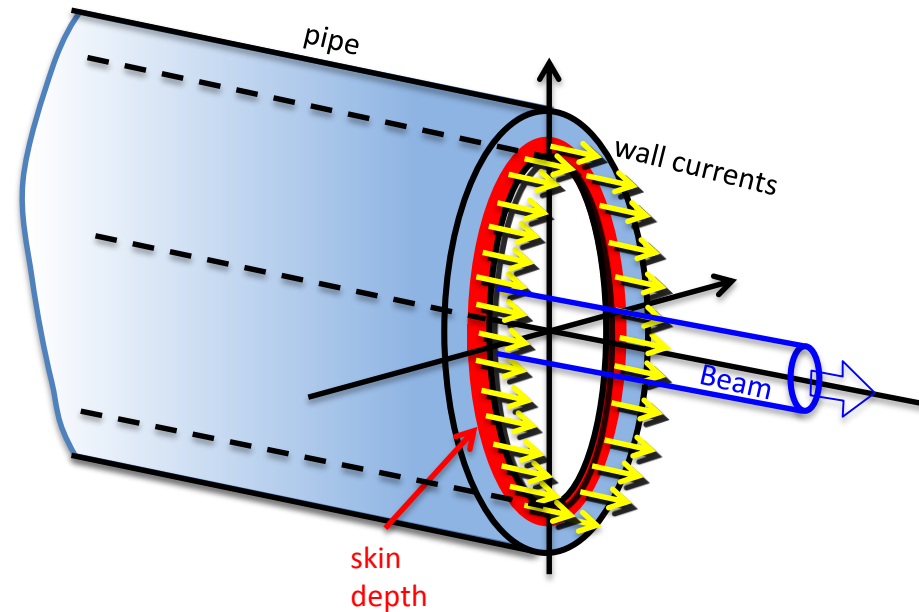
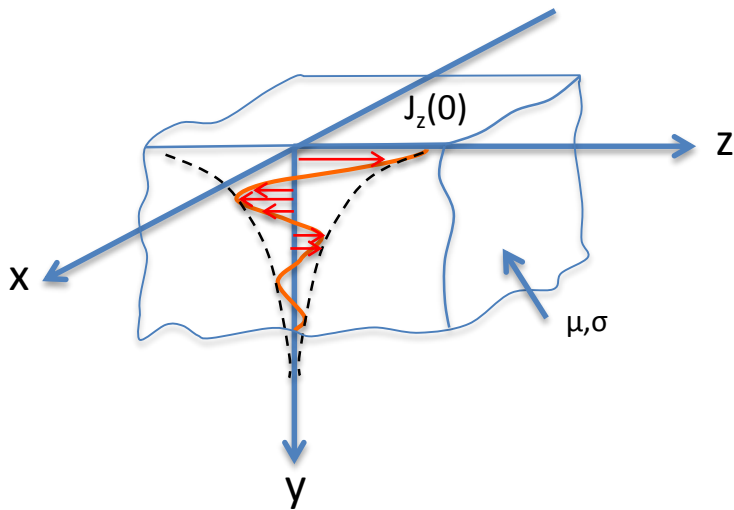

Summary

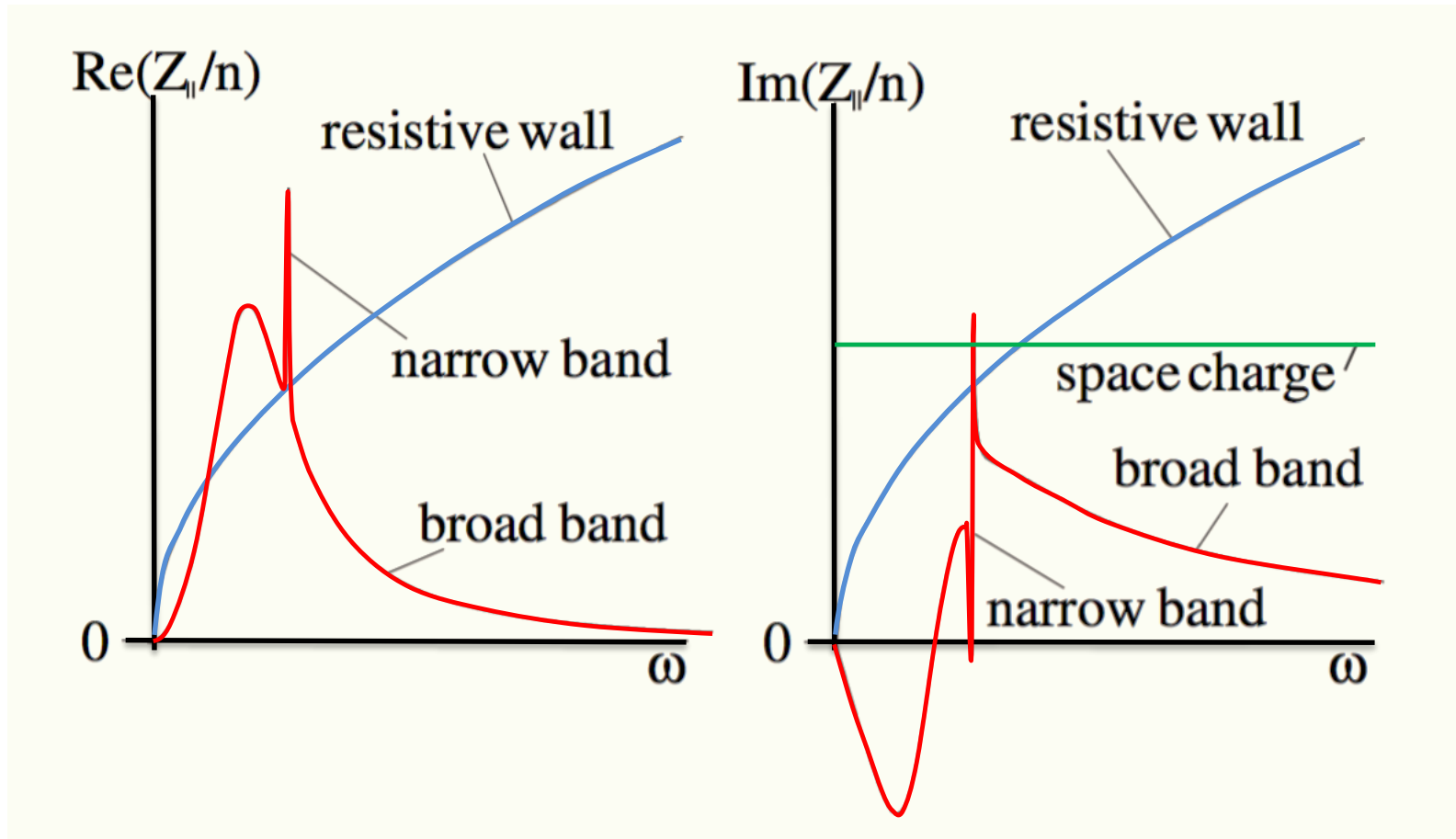

From H. Widemann book

Transverse impedance

Origin

Beam passing through
a cavity on axis

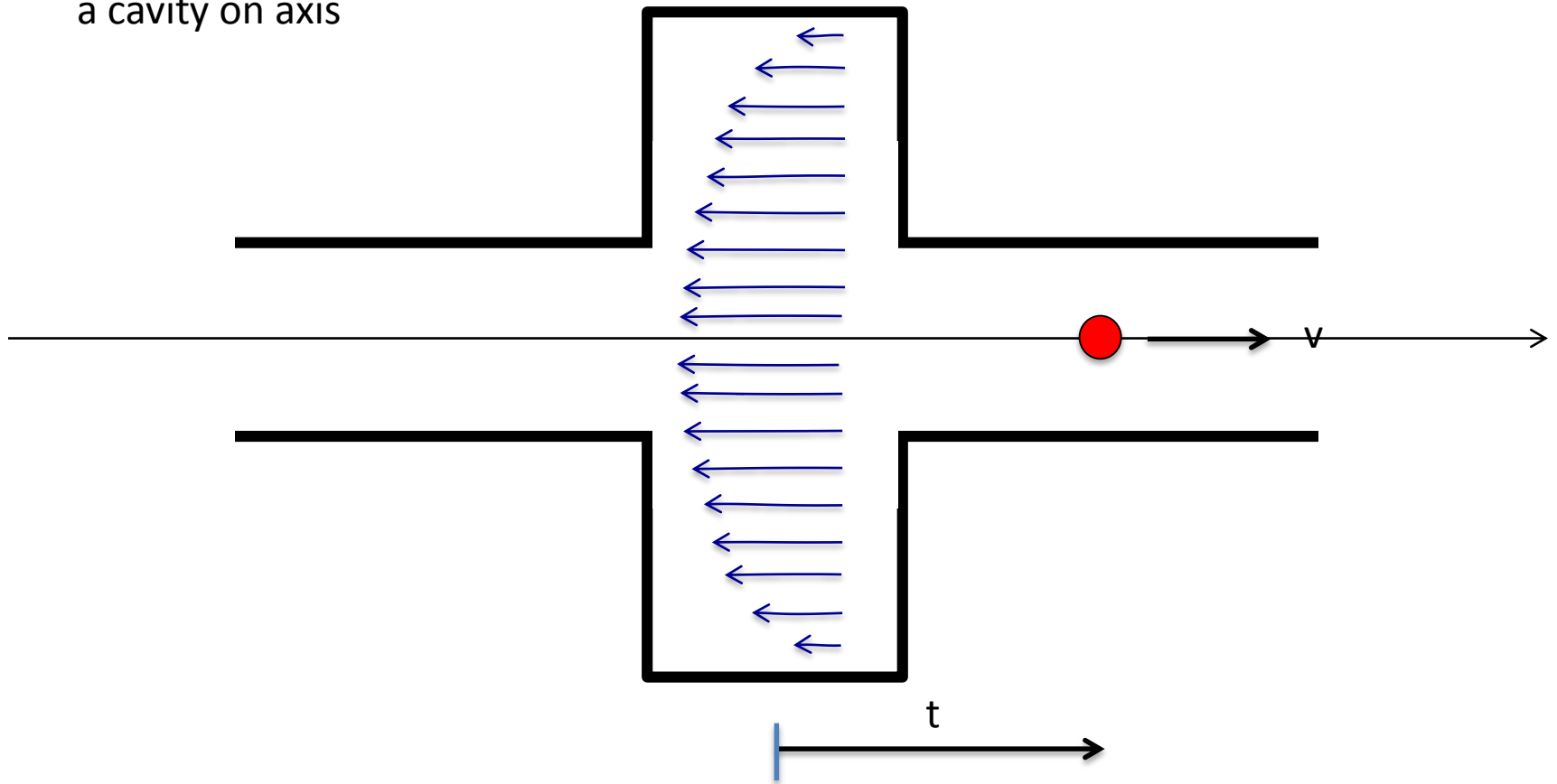

Origin

Beam passing through
a cavity off-axis

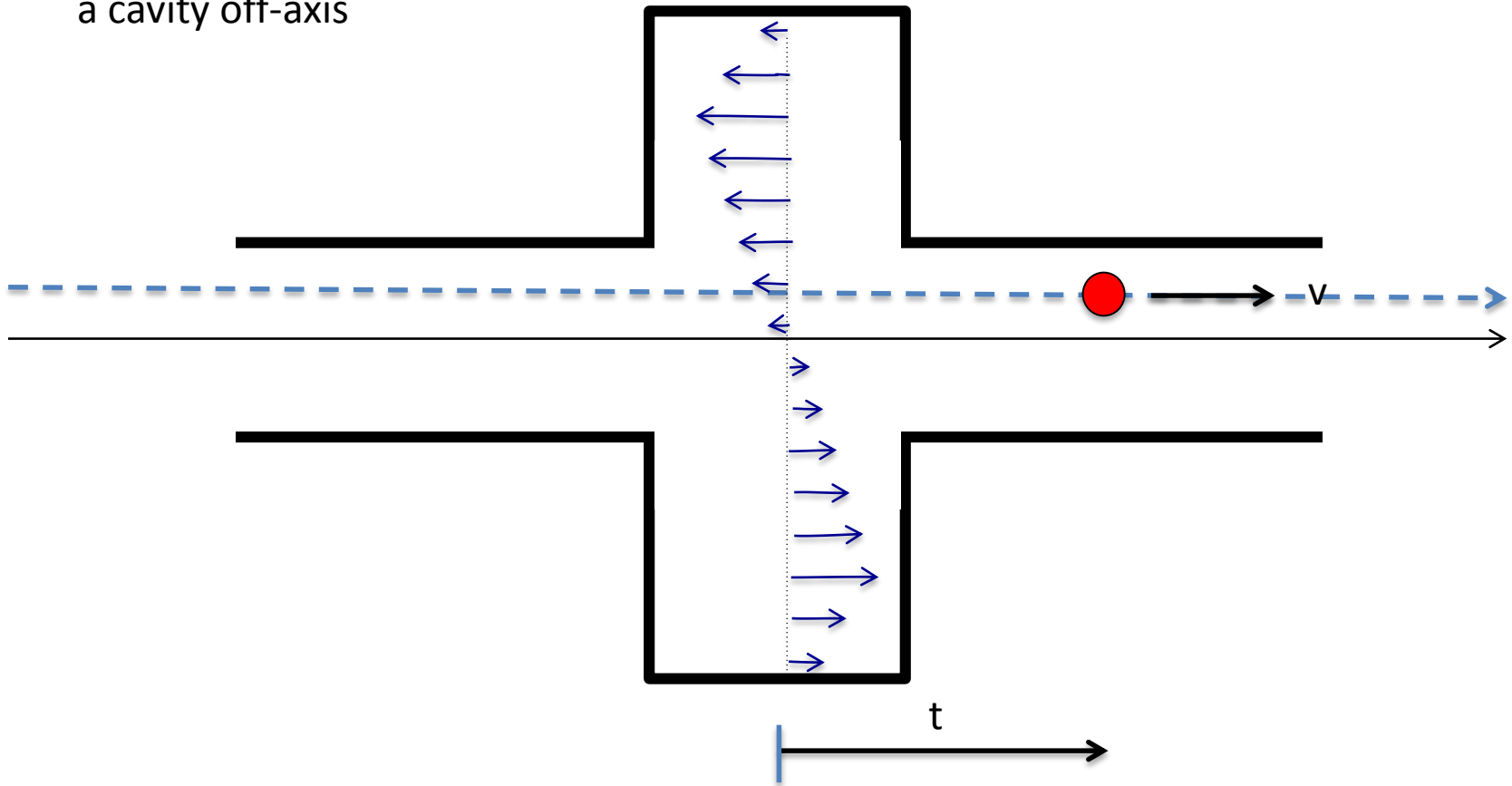

But the field transform it-self !

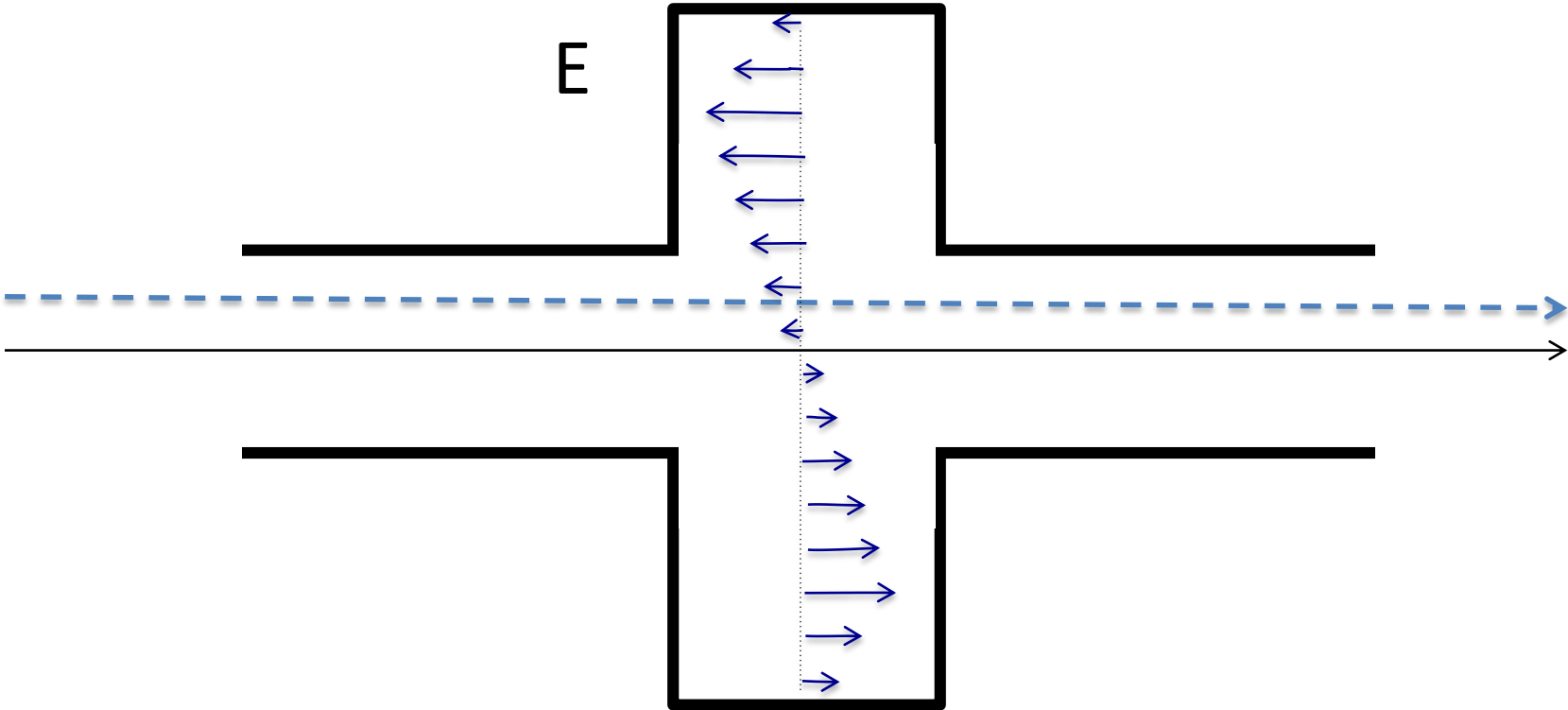

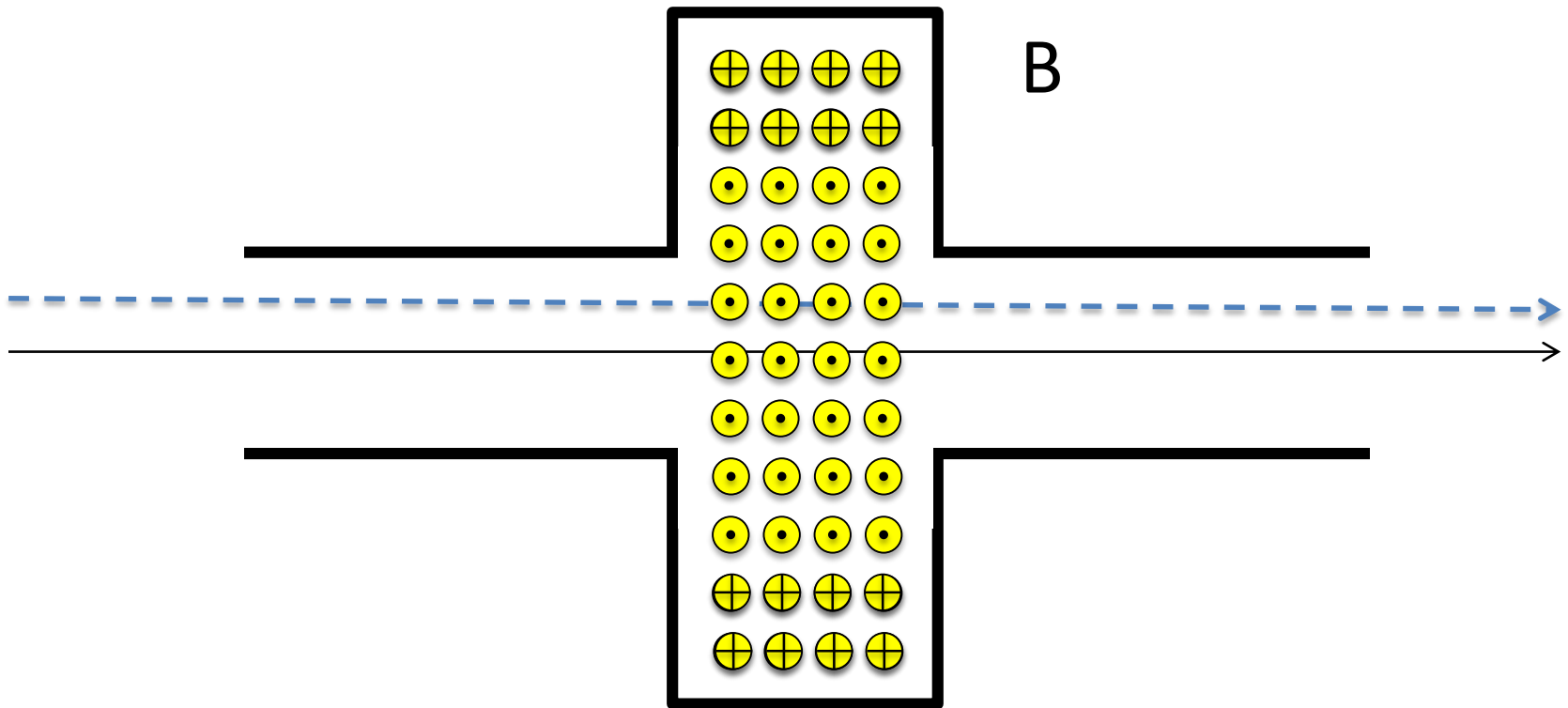

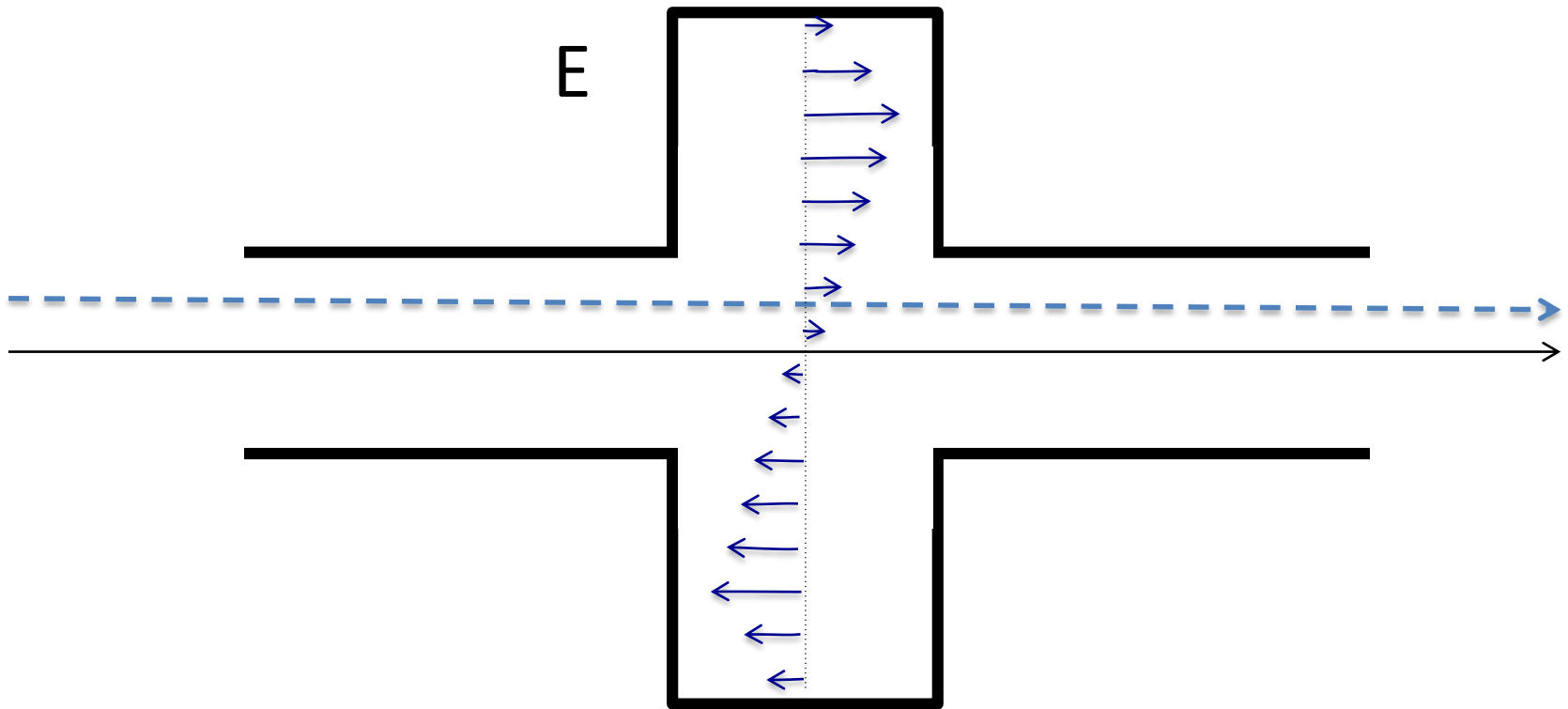

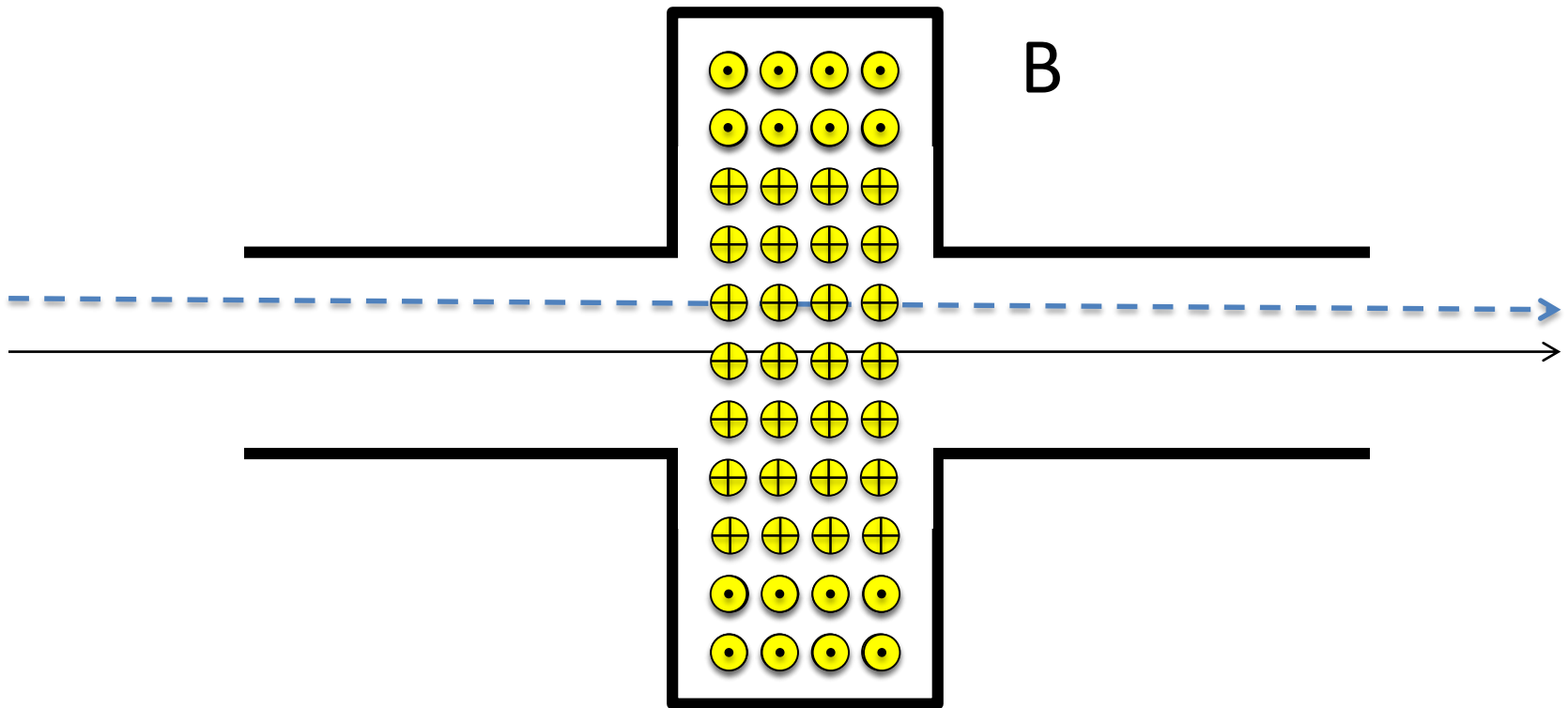

Effect on the dynamics

The dynamics is much more affected by B, than E because

$$\vec{F} = q\vec{E} + q\vec{v} \times \vec{B}$$



this speed is high

The beam creates its own dipolar magnetic field !

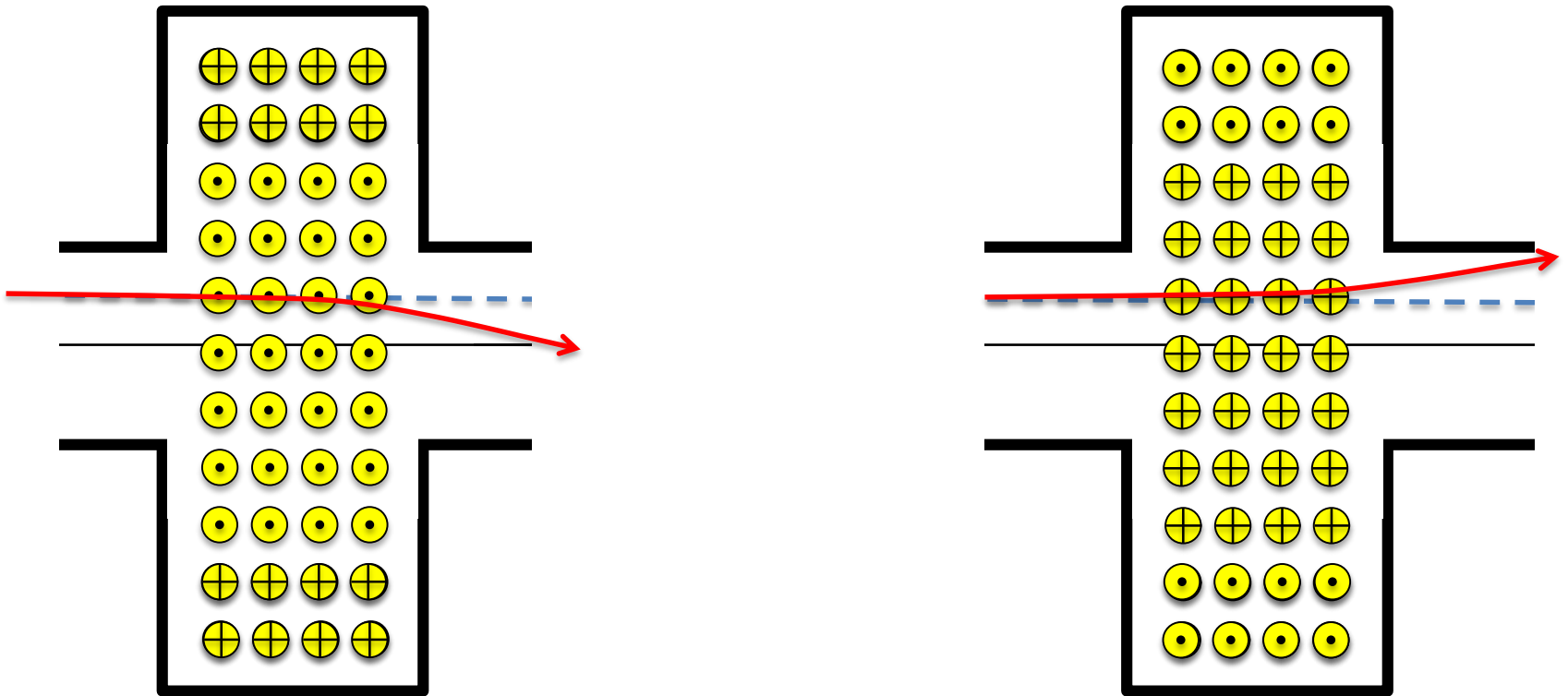

(dipolar errors create integer resonances.... we expect the same...)

Transverse impedance

Definition of longitudinal impedance (classical)

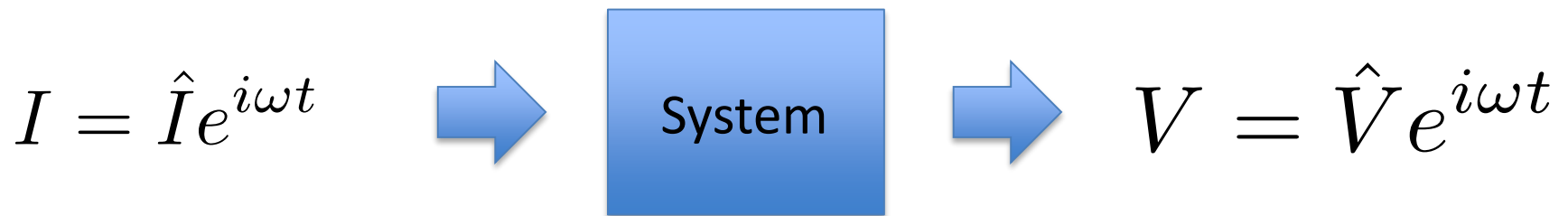

Impedance

$$Z(\omega) = \hat{V} / \hat{I}$$

For a displaced beam

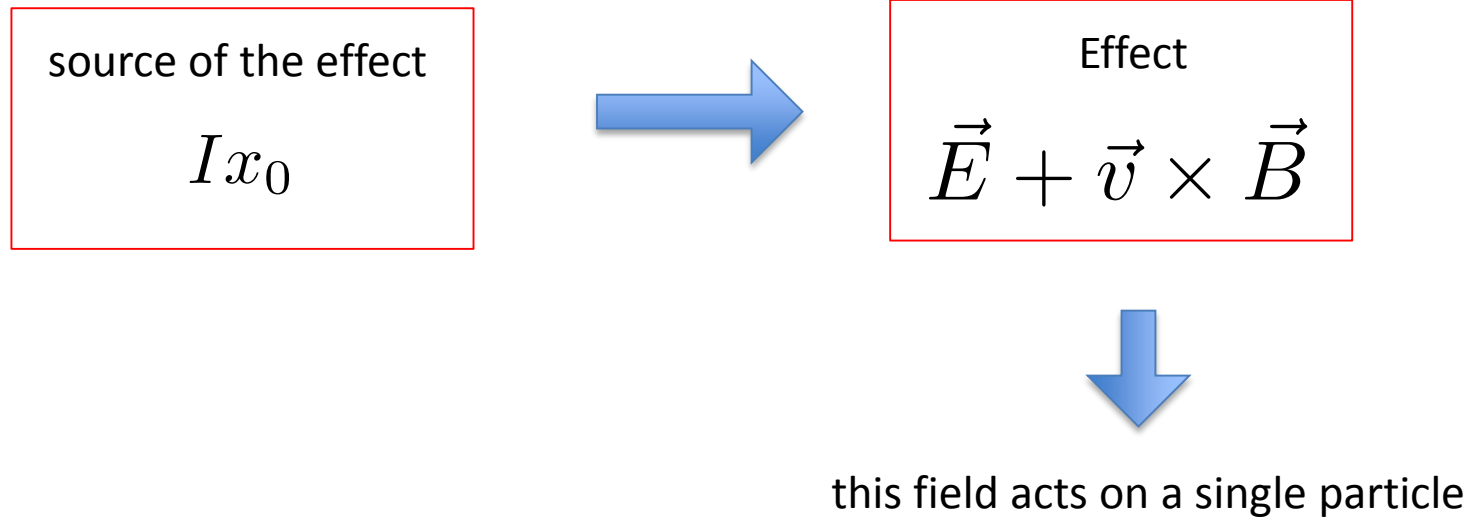

It means that in the equation of motion we have to add this effect

$$\frac{d^2x}{ds^2} + k_x x = \frac{q}{m\gamma v_0^2} [E_x + (\vec{v} \times \vec{B})_x]$$

therefore for a weak effect or distributed we find

$$\frac{d^2 x}{ds^2} + \left(\frac{Q_x}{R} \right)^2 x = \frac{q}{m\gamma v_0^2} \frac{1}{2\pi R} \int_0^{2\pi R} [E_x + (\vec{v} \times \vec{B})_x] ds$$

In the time domain

$$\frac{d^2 x}{dt^2} + (Q_x \omega_0)^2 x = \frac{q}{m\gamma} \frac{1}{2\pi R} \int_0^{2\pi R} [E_x + (\vec{v} \times \vec{B})_x] ds$$

But $\int_0^{2\pi R} [E_x + (\vec{v} \times \vec{B})_x] ds$ is like a “strange” voltage

$$V = - \int_0^{2\pi R} [\vec{E} + \vec{v} \times \vec{B}]_{\perp} ds$$

Now the situation is the following:

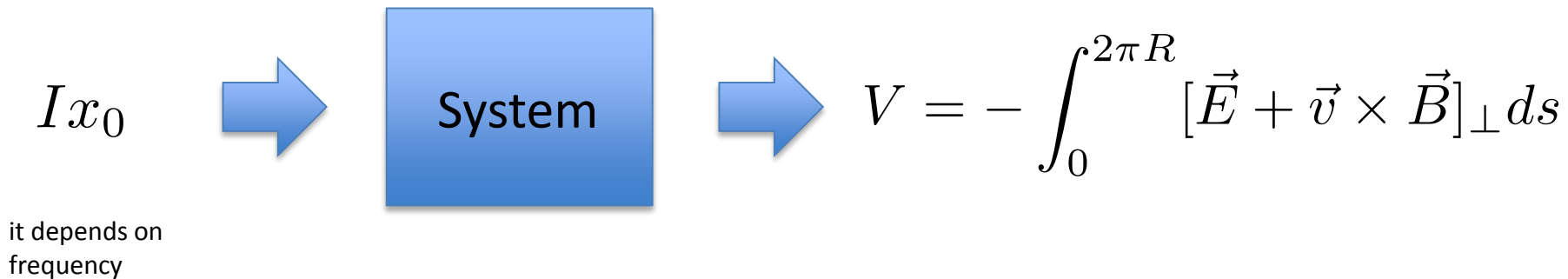

Transverse beam coupling impedance

$$Z_{\perp}(\omega) = i \frac{\int_0^{2\pi R} [\vec{E} + \vec{v} \times \vec{B}]_{\perp} ds}{\beta I x_0}$$



now the question is
what is ω ?

What is it ω ?

It is given by the fractional tune, as this is the frequency seen in a cavity

Example: $Q = 2.23$ fractional tune $q = 0.23$

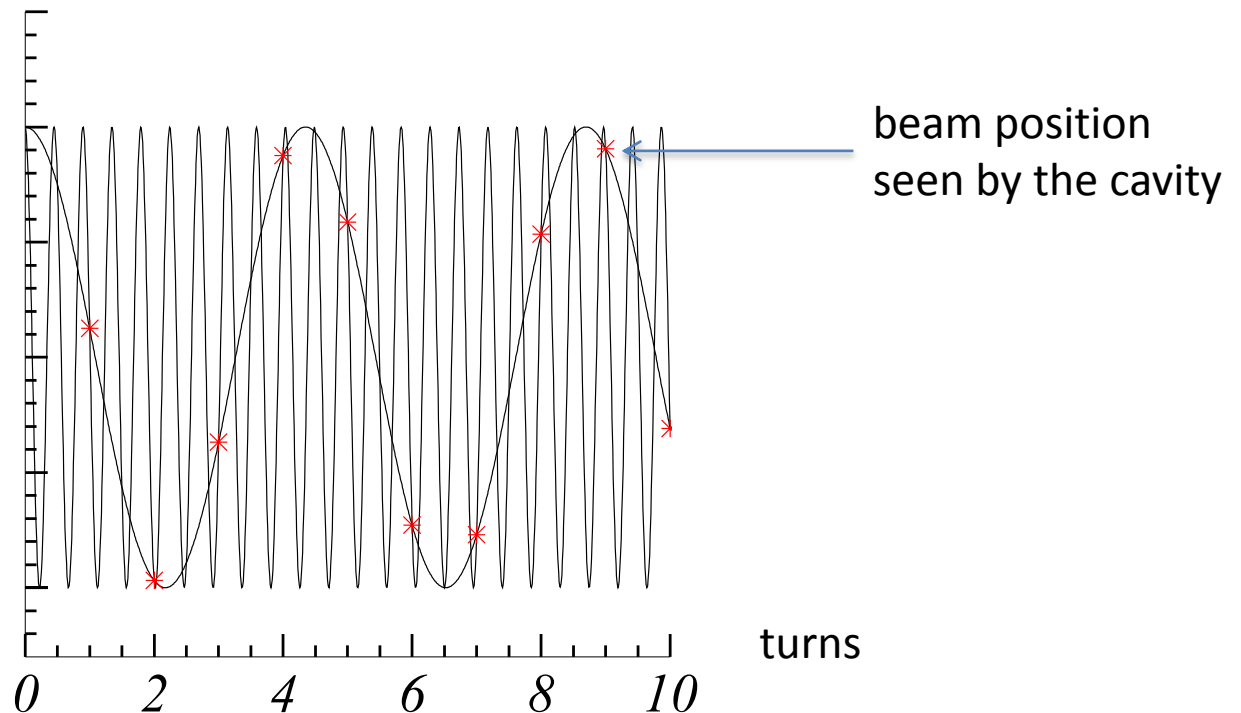

B-field induced by beam displacement

From $\frac{\partial E_z}{\partial x} = kIx_0$  $E_z = kIx_0x$

electric field at the position of beam x_0 is

$$E_z(x_0) = kIx_0^2$$

Longitudinal impedance

$$Z_{||} = -\frac{E_z(x_0)l}{I} = -kx_0^2l$$

The magnetic field comes from Maxwell

$$\nabla \times \vec{E} + \frac{\partial \vec{B}}{\partial t} = \vec{0}$$

$$\frac{\partial B_y}{\partial t} \Big|_{x_0} = k I x_0 \quad \text{taking} \quad I x_0 = I \hat{x} e^{i\omega t}$$



$$B_y = \frac{k I \hat{x}}{i\omega} e^{i\omega t} = \frac{k I x_0}{i\omega}$$

Transverse impedance

$$Z_{\perp} = i \frac{\int_0^l [\vec{v} \times \vec{B}]_{\perp} ds}{I x_0} \quad \img alt="A blue arrow pointing to the right, indicating a derivation step." data-bbox="491 648 601 722"/> \quad Z_{\perp} = -\frac{v_z k l}{\omega}$$

$$Z_{\perp} = \frac{v_z}{2\omega} \frac{d^2 Z_{\parallel}(\omega)}{dx^2}$$

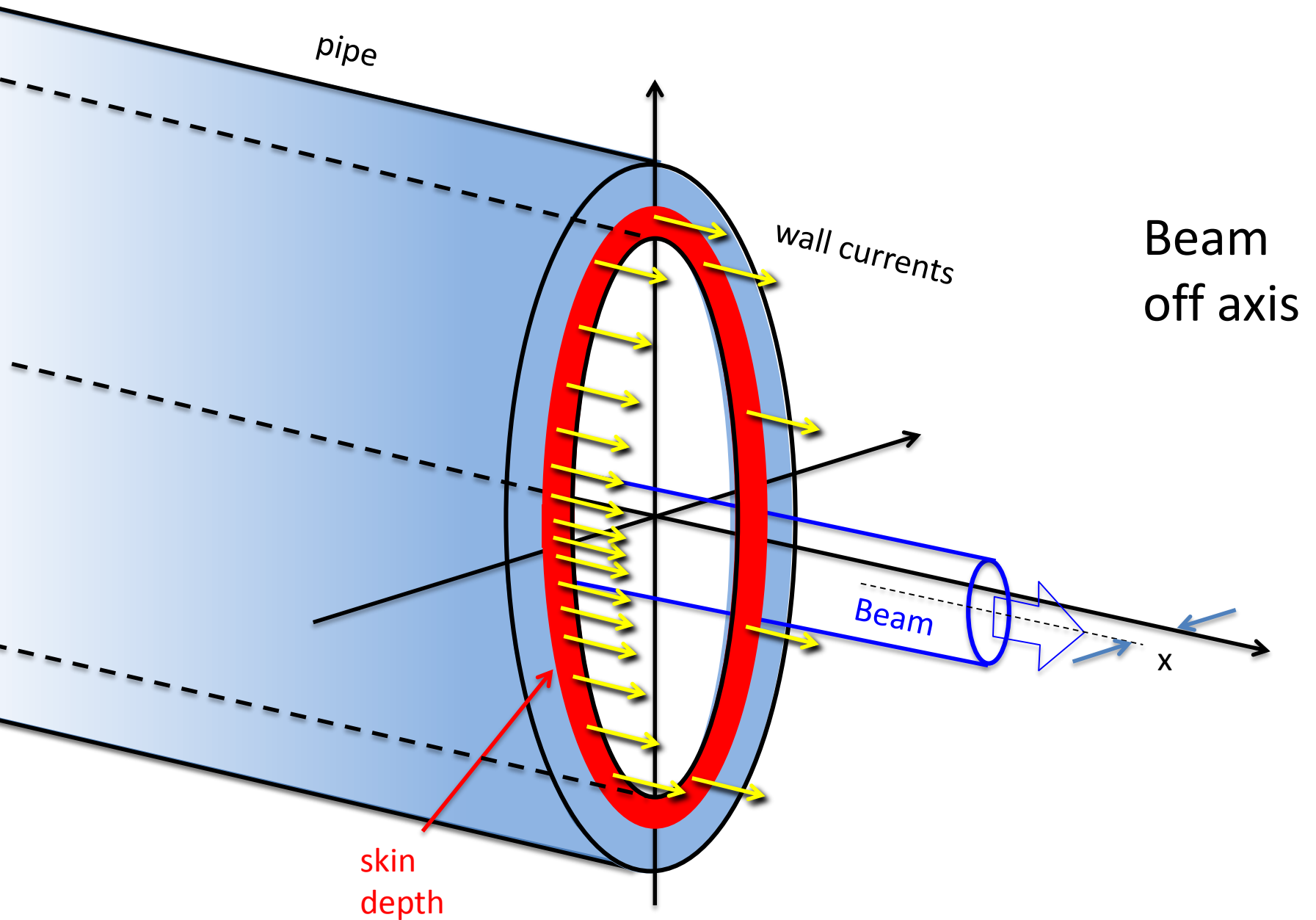

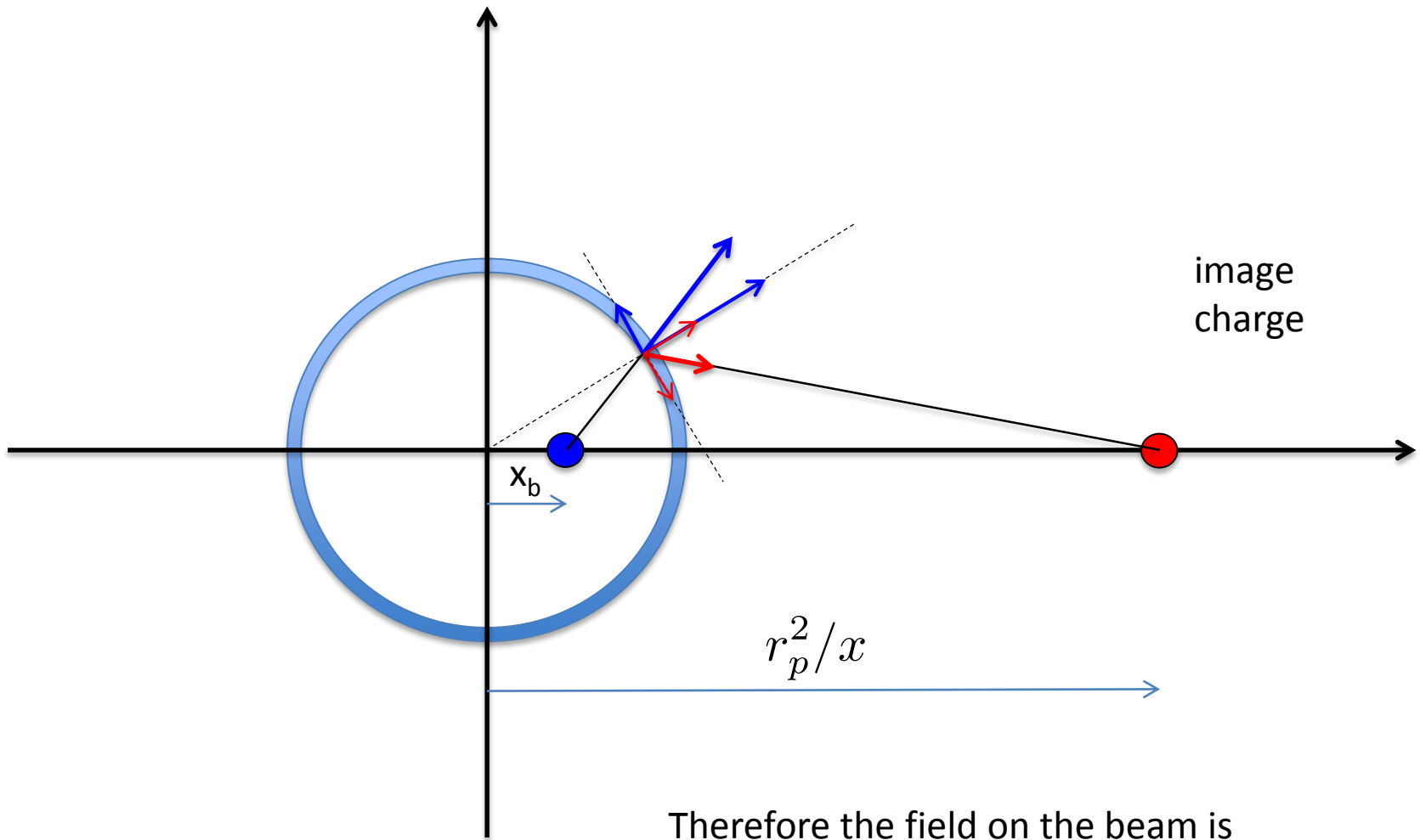

$$E_x = \frac{1}{2\pi\epsilon_0} \frac{\lambda}{r_p^2} x_b$$

(for small x_b/r_p)

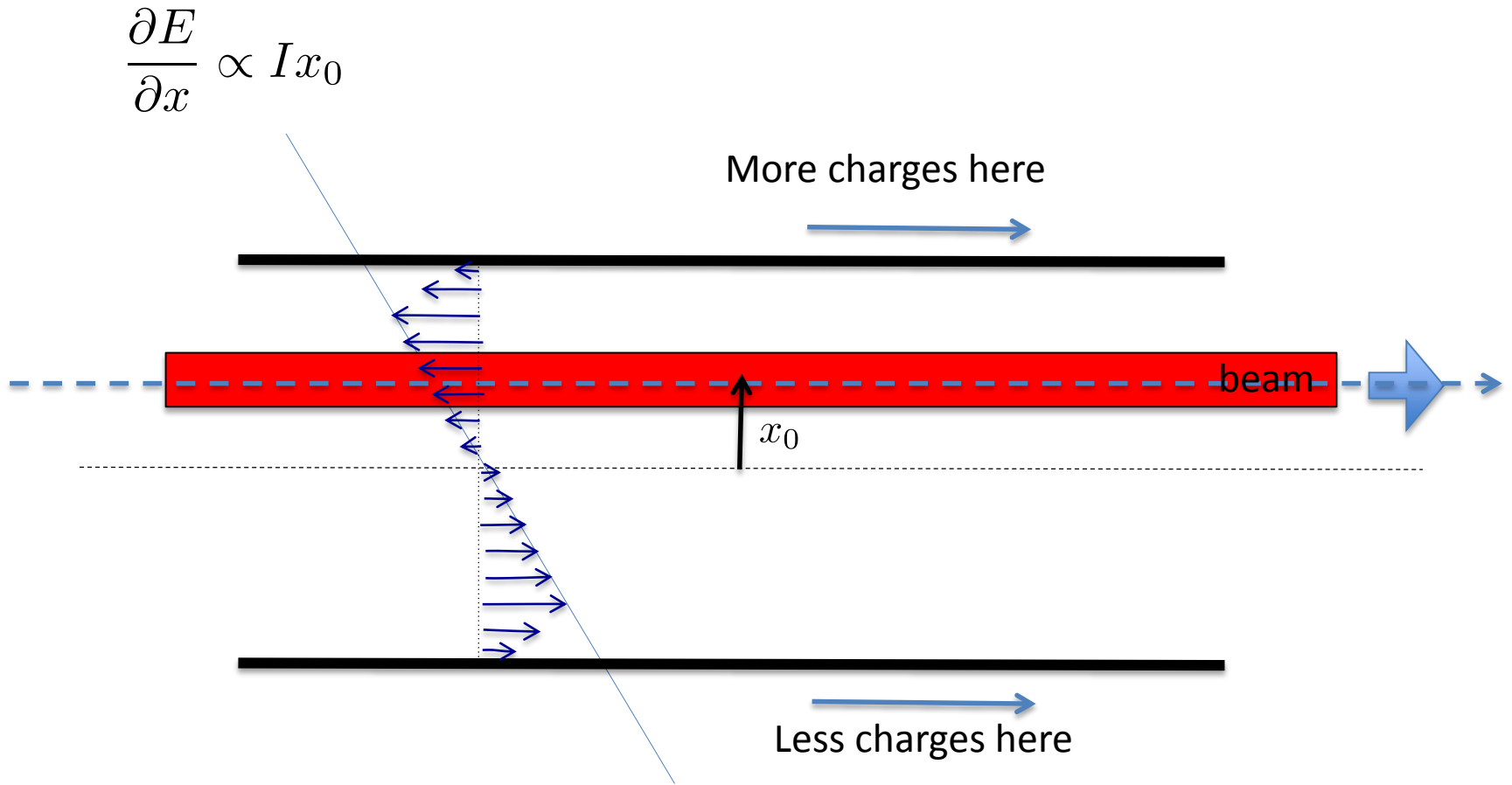

Transverse resistive Wall impedance

$$Z(\omega_n)_\perp = \frac{2R}{r_p^2} \frac{Z_{||}(\omega_n)}{n} \Big|_{res}$$

Transverse instability

Coasting beam instability

Force due to the impedance
(in the complex notation)

$$F_{\perp} = i \frac{q Z_{\perp} I_0}{2\pi R} x_b$$



Equation of motion of one
particle for a beam on axis

$$\ddot{x} + Q^2 \omega_0^2 x = 0$$

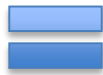

Equation of motion of a
beam particle when the beam
is off-axis

$$\ddot{x} + Q^2 \omega_0^2 x = -i \frac{q Z_{\perp} I_0}{2\pi R m \gamma} x_b$$

Collective motion

On the other hand the beam center is $x_b = \int x n(x, y, s) dx dy$

with $\int \tilde{n} dV = 1$

therefore

$$\int \ddot{x} \tilde{n} dV + \int Q^2 \omega_0^2 x \tilde{n} dV = -i \frac{q Z_{\perp} I_0}{2\pi R m \gamma} x_b$$

If all particles have the same frequency, i.e. each particle experience a force

$$Q^2 \omega^2 x$$

then $\ddot{x}_b + Q^2 \omega_0^2 x_b = -i \frac{q Z_{\perp} I_0}{2\pi R m \gamma} x_b$

$$\ddot{x}_b + Q^2 \omega_0^2 x_b = -i \frac{qZ_{\perp} I_0}{2\pi R m \gamma} x_b$$

We can define a coherent “detuning” because this is a linear equation

$$Q^2 \omega_0^2 + i \frac{qZ_{\perp} I_0}{2\pi R m \gamma} = (Q + \Delta Q^c)^2 \omega_0^2$$



$$\Delta Q^c = i \frac{1}{2Q\omega_0^2} \frac{qZ_{\perp} I_0}{2\pi R m \gamma}$$

$$\ddot{x}_b + Q^2 \omega_0^2 x_b = -2Q\omega^2 \Delta Q^c x_b$$

that is

$$\ddot{x}_b + (Q^2 \omega_0^2 + 2Q\omega_0^2 \Delta Q^c) x_b = 0$$

But now ΔQ^c is a complex number !!

Solution $x_b = A \exp[-\omega_0 I_m(\Delta Q^c)t + i\omega_0[Q + Re(\Delta Q^c)]t]$

$$\tau_I^{-1} = \omega_0 \text{Im}(\Delta Q^c)$$

Is the growth rate of the transverse resistive wall instability

$$\frac{1}{\tau} = \frac{q \text{Re}\{Z_{\perp}\} I_0}{4\pi R m \gamma Q \omega_0}$$

This instability always take place

Instability suppression

→ Landau damping

An important assumption

We assumed that all particles have the same frequency so that

$$\int Q^2 \omega_0^2 x \tilde{n} dV = Q^2 \omega_0^2 \int x \tilde{n} dV = Q^2 \omega_0^2 x_b$$

This assumption means that each particle of the beam respond in the same way to a change of particle amplitude

Coherent motion

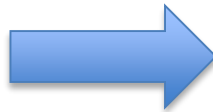

drive particle motion, which is again coherent

Chromaticity ?

What happens if the incoherent force created by the accelerator does not allow a coherent build up

Momentum spread

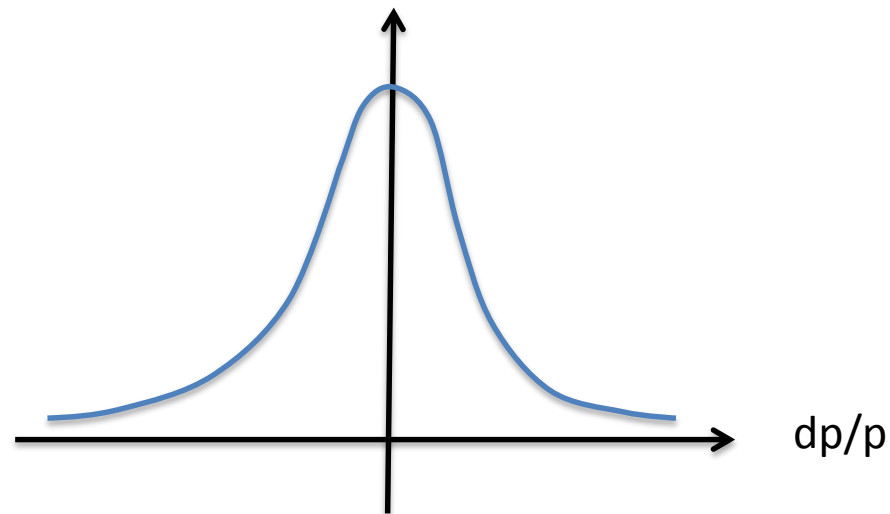

$$\delta Q = \xi \frac{\delta p}{p}$$

chromaticity



one particle with off-momentum dp/p
has tune

$$Q = Q_0 + \delta Q = Q + \xi \frac{\delta p}{p}$$

If each particle of the beam has different dp/p then the force that the lattice exert on a particle depends on the particle !

$$F_x = \left(Q_0 + \xi \frac{\delta p}{p} \right)^2 \omega^2 x$$

Incoherent motion damps x_b

Equation of motion
without impedances

$$\ddot{x} + \left(Q_0 + \xi \frac{\delta p}{p} \right)^2 \omega^2 x = 0$$

Motion of center of mass has an effect on the spread of the frequencies of oscillation

The momentum compaction also provides a spread of the betatron oscillations

Example:
N. particles = 5
 $dq/q = 0$

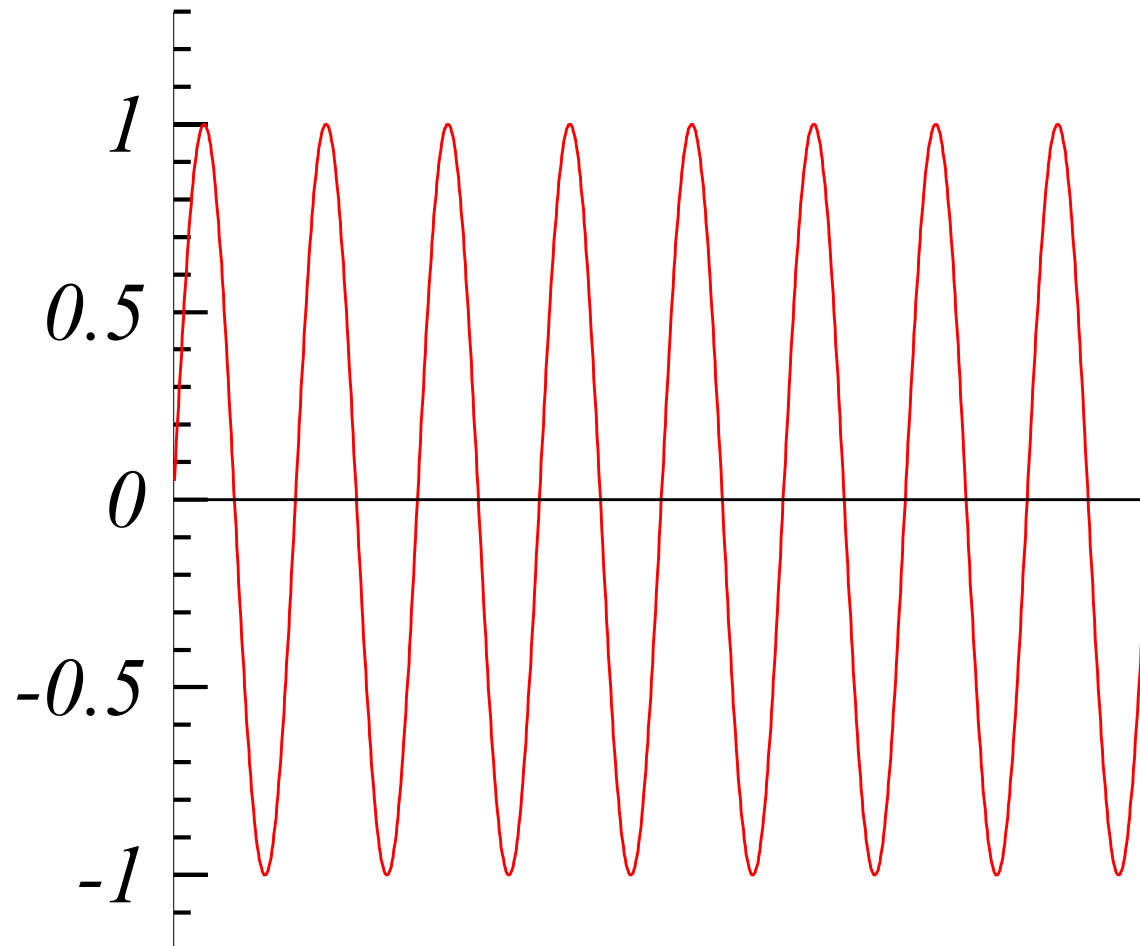

Example:
N. particles = 5
 $dq/q = 5E-3$

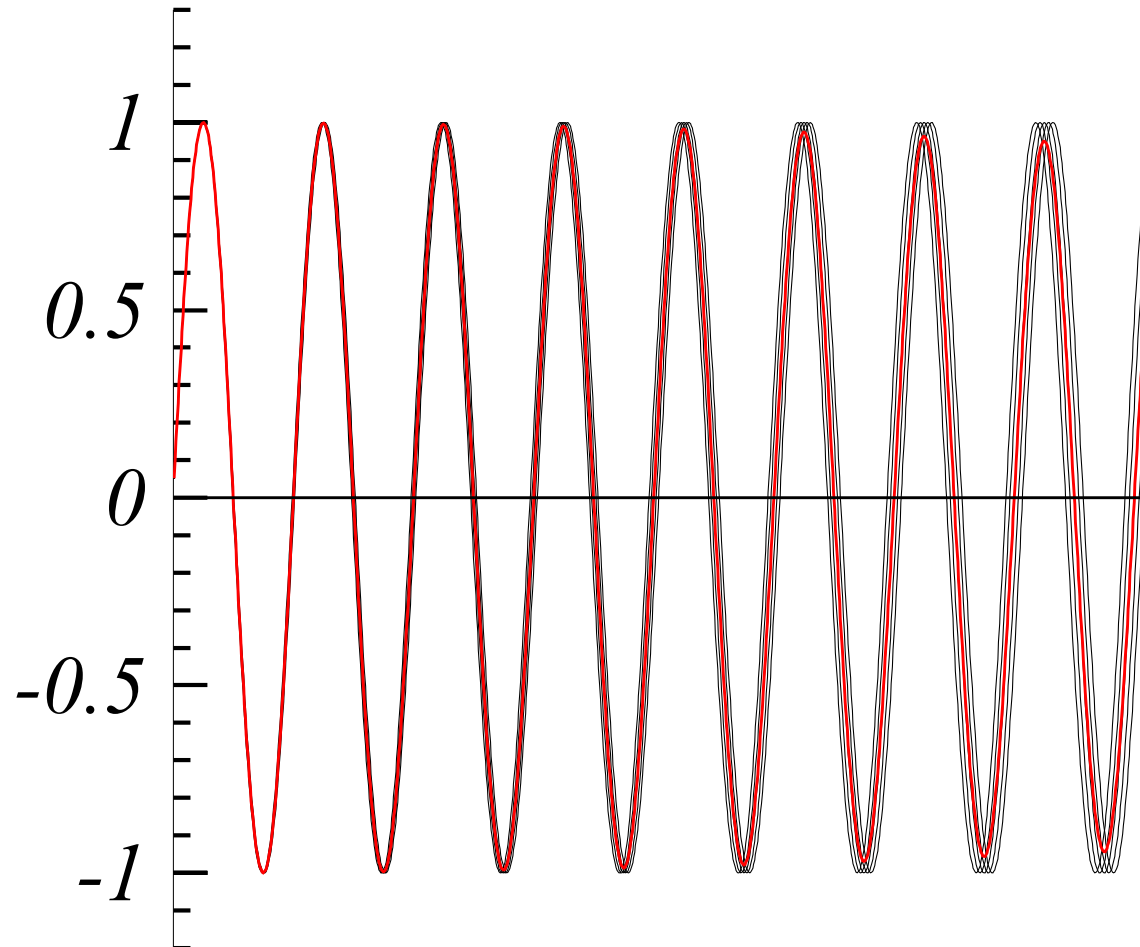

Example:
N. particles = 5
 $dq/q = 1E-2$

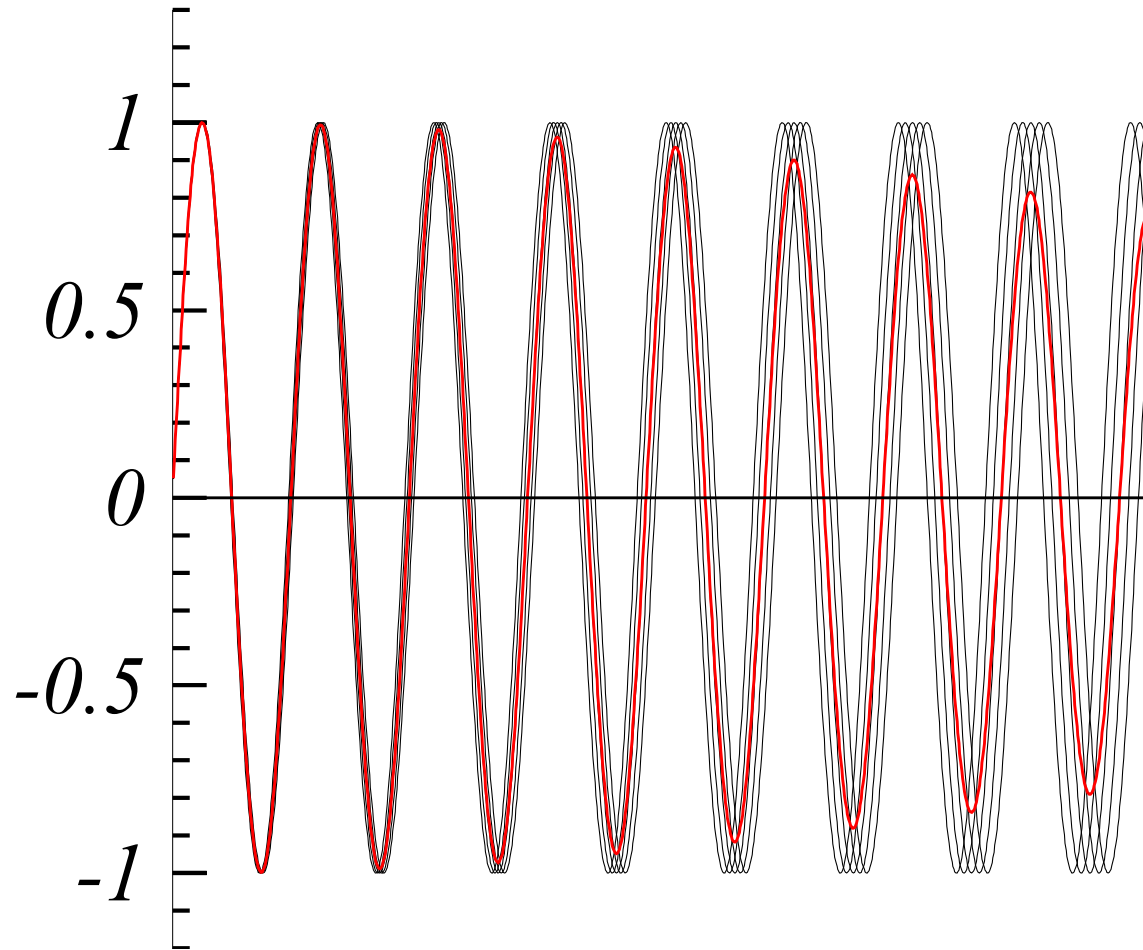

Example:
N. particles = 5
 $dq/q = 2.5E-2$

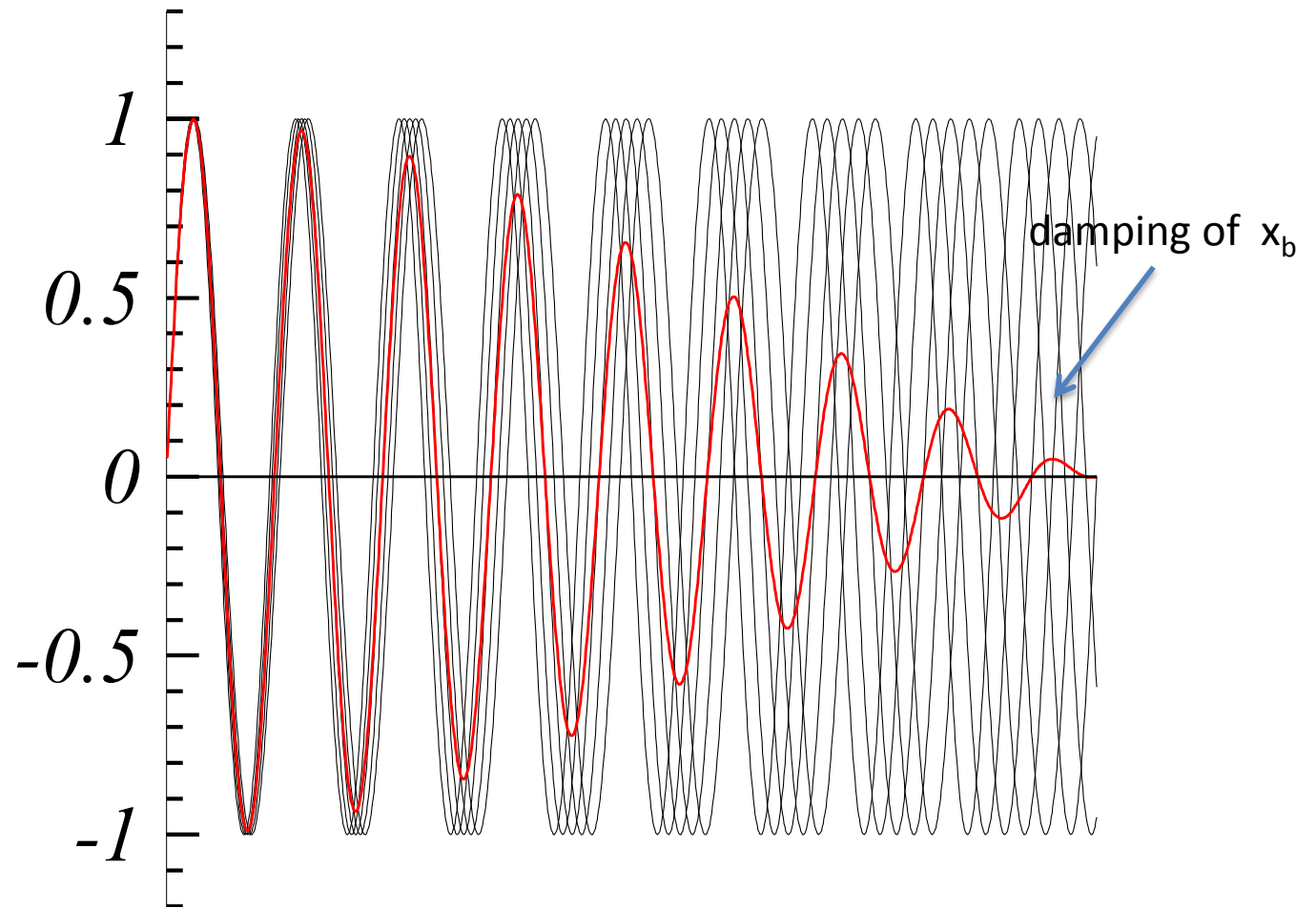

But incoherent motion reduces x_b

Example:
these are 5 sinusoids
with amplitude linearly
growth

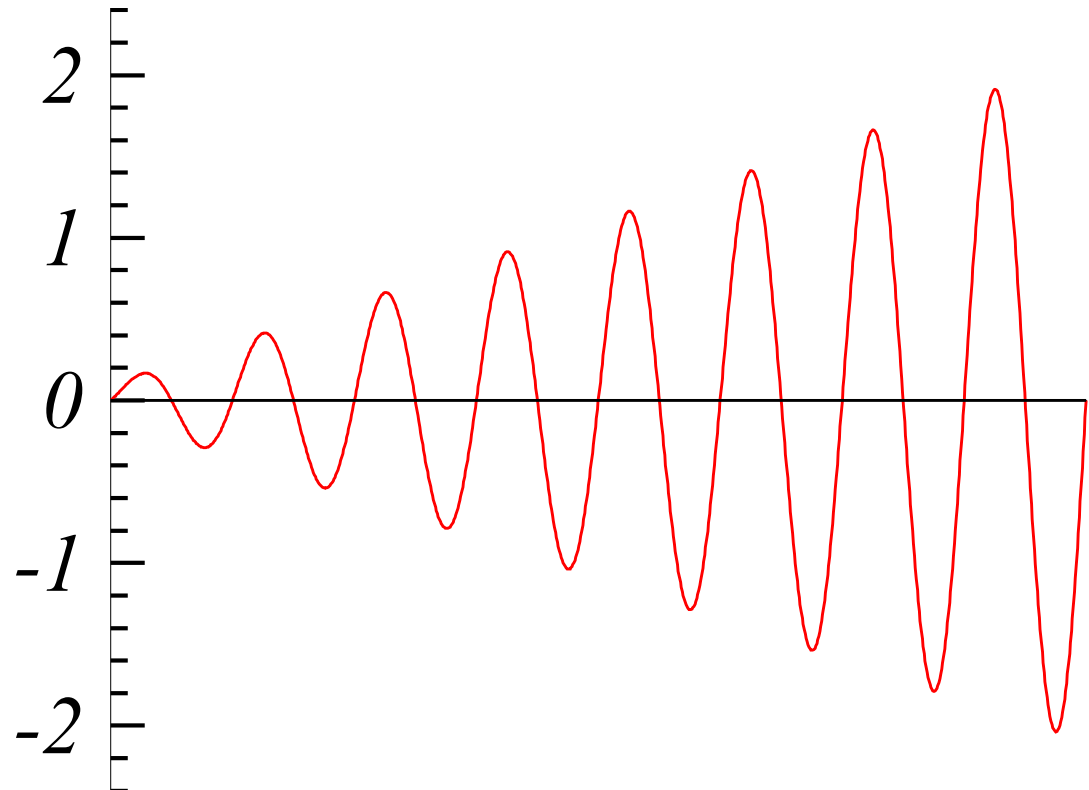

Example:
now a spread dq/q of
 $1E-2$ is added to the
5 curves



The center of mass
growth slower

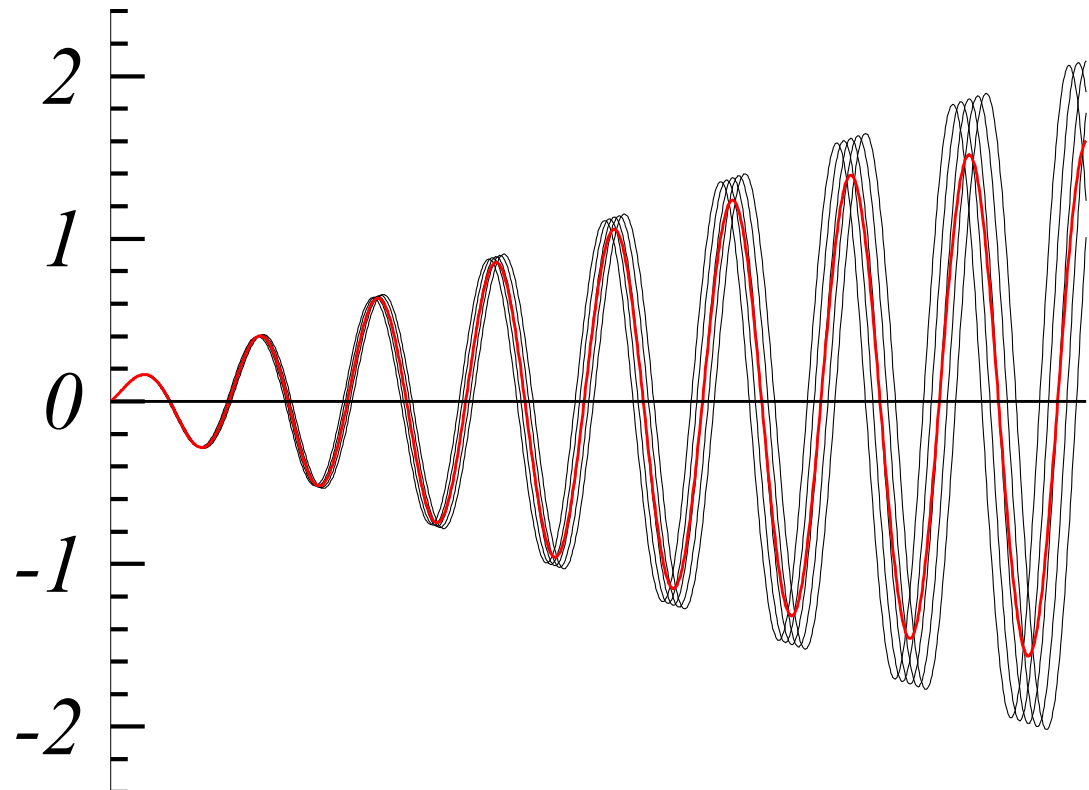

Example:
now a spread dq/q of
 $1E-2$ is added to the
5 curves



the spread of the
particles damps the
oscillations of the center of
mass \rightarrow the instability cannot develop

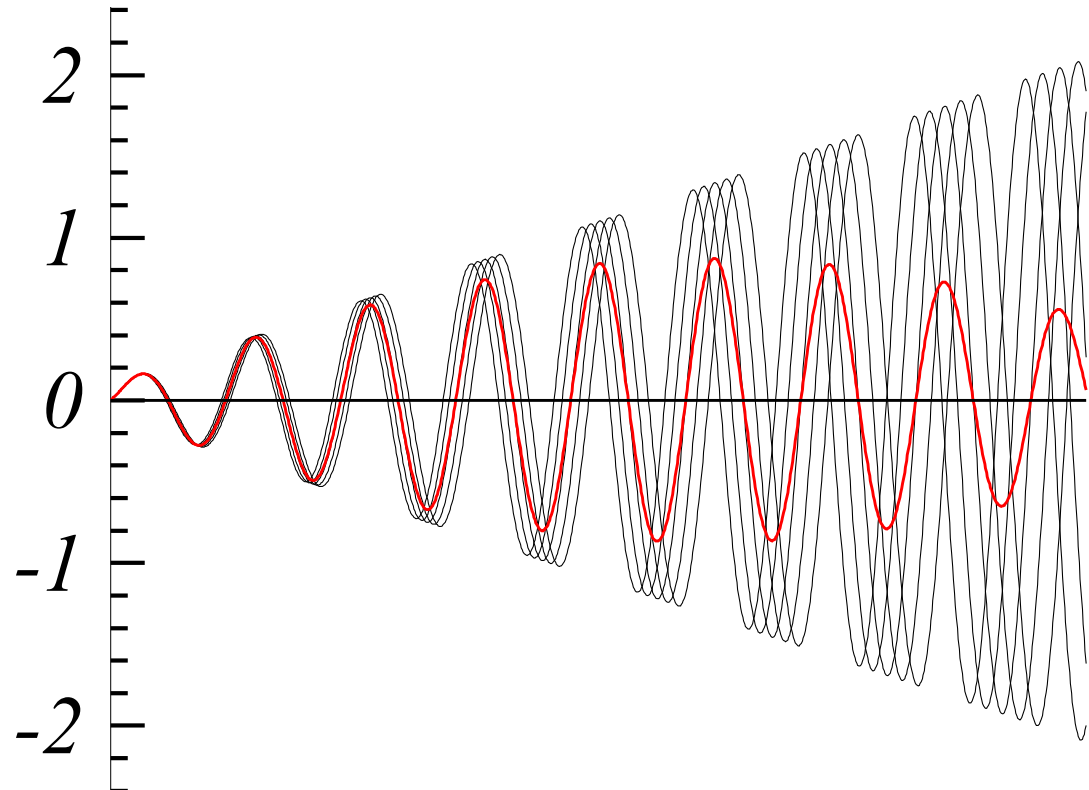

Situation

Coherent
effect

Growth rate

$$\tau_I$$

$$\frac{1}{\tau} = \frac{q \operatorname{Re}\{Z_{\perp}\} I_0}{4\pi R m \gamma Q \omega_0}$$



The faster wins

Incoherent
effect

Damping rate

$$\tau_D$$

$$|Z_{\perp}(n\omega_0 + \omega_{\beta})| < Z_0 \frac{2\pi R \gamma | -n\eta + \xi \nu_{\beta} |}{\sqrt{3} N r_0 \beta_Z} \Delta \delta_{1/2}$$

Stability condition (Chao)

instability of a single bunch

Example

beam position at the cavity

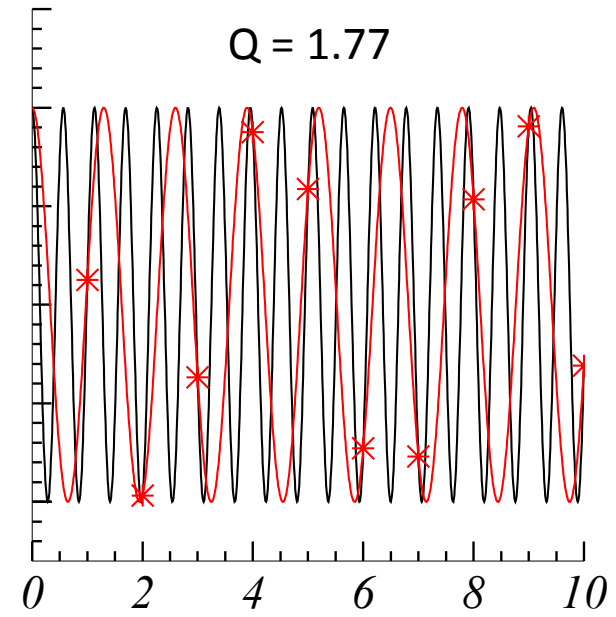
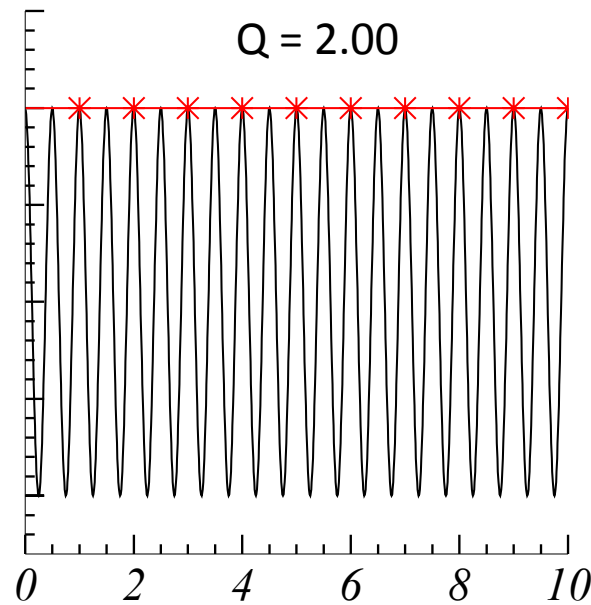
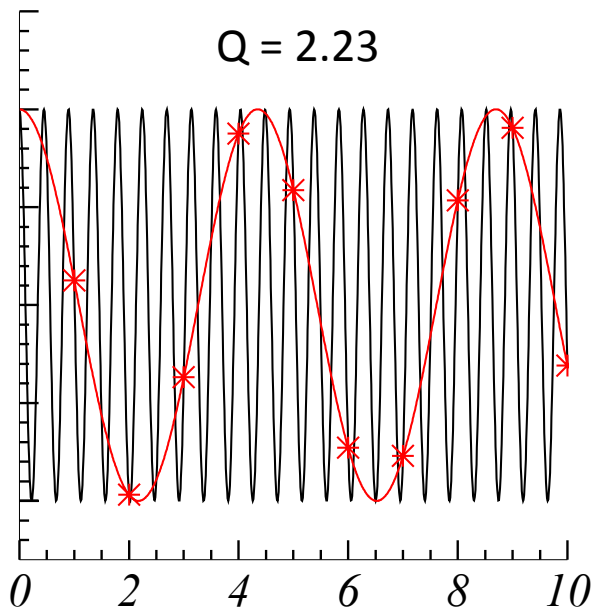

No oscillations →

$$\omega = 0$$

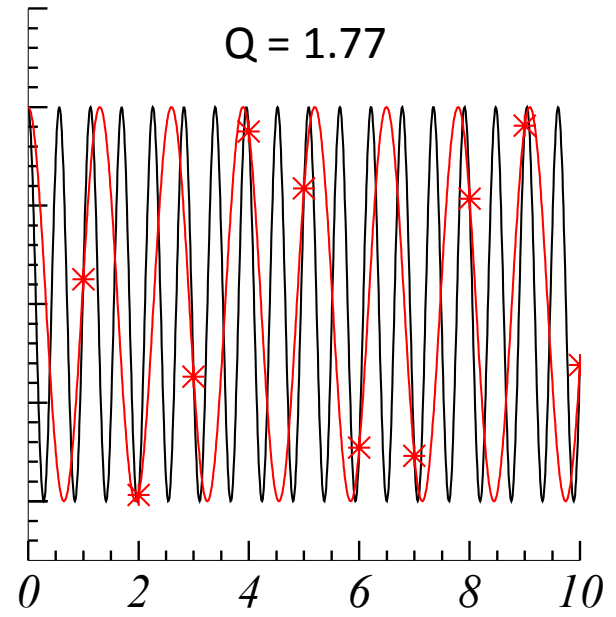
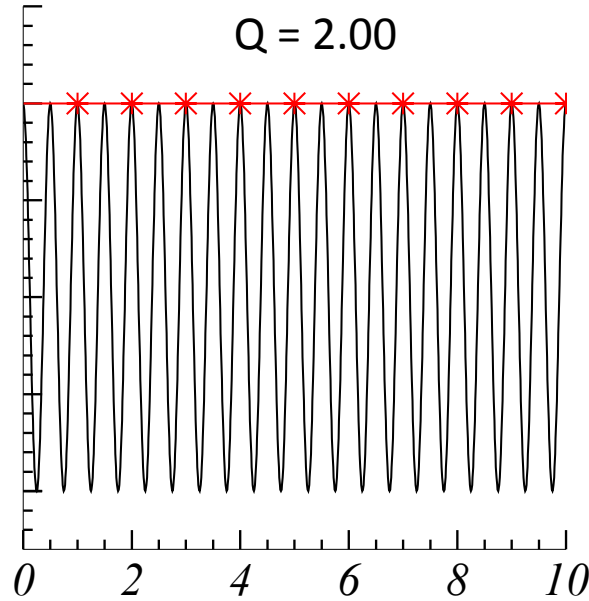
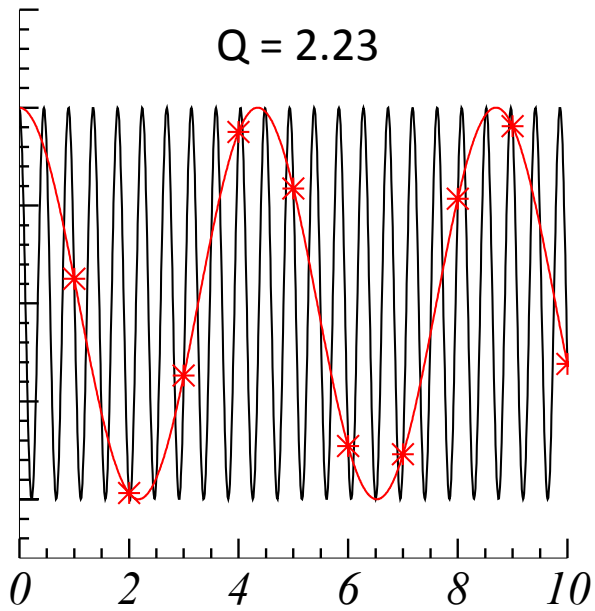

Slow

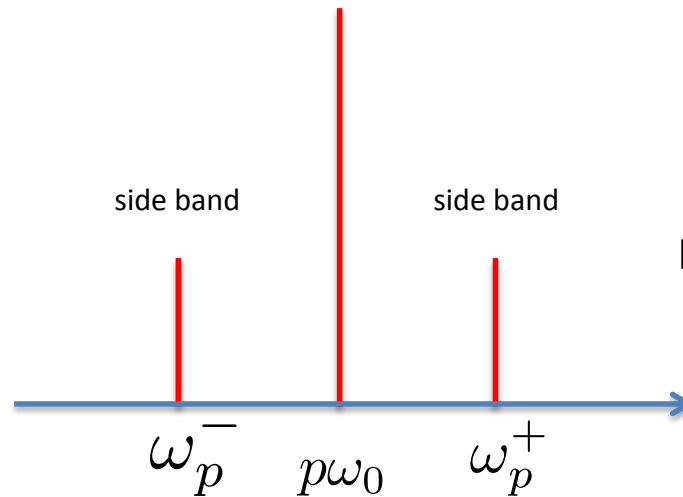

Fast

$$\omega_p^\pm = (p \pm q)\omega_0$$

behavior of the field in the cavity

T_r = time of oscillation of the field in the cavity

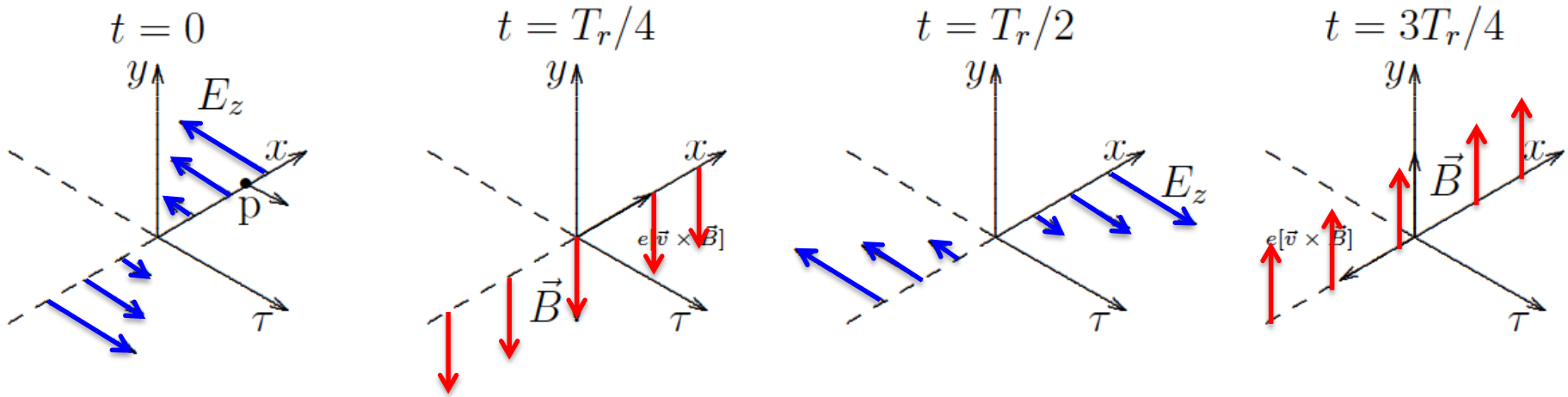

Cavity tuned upper sideband

Example with $q=1/4$

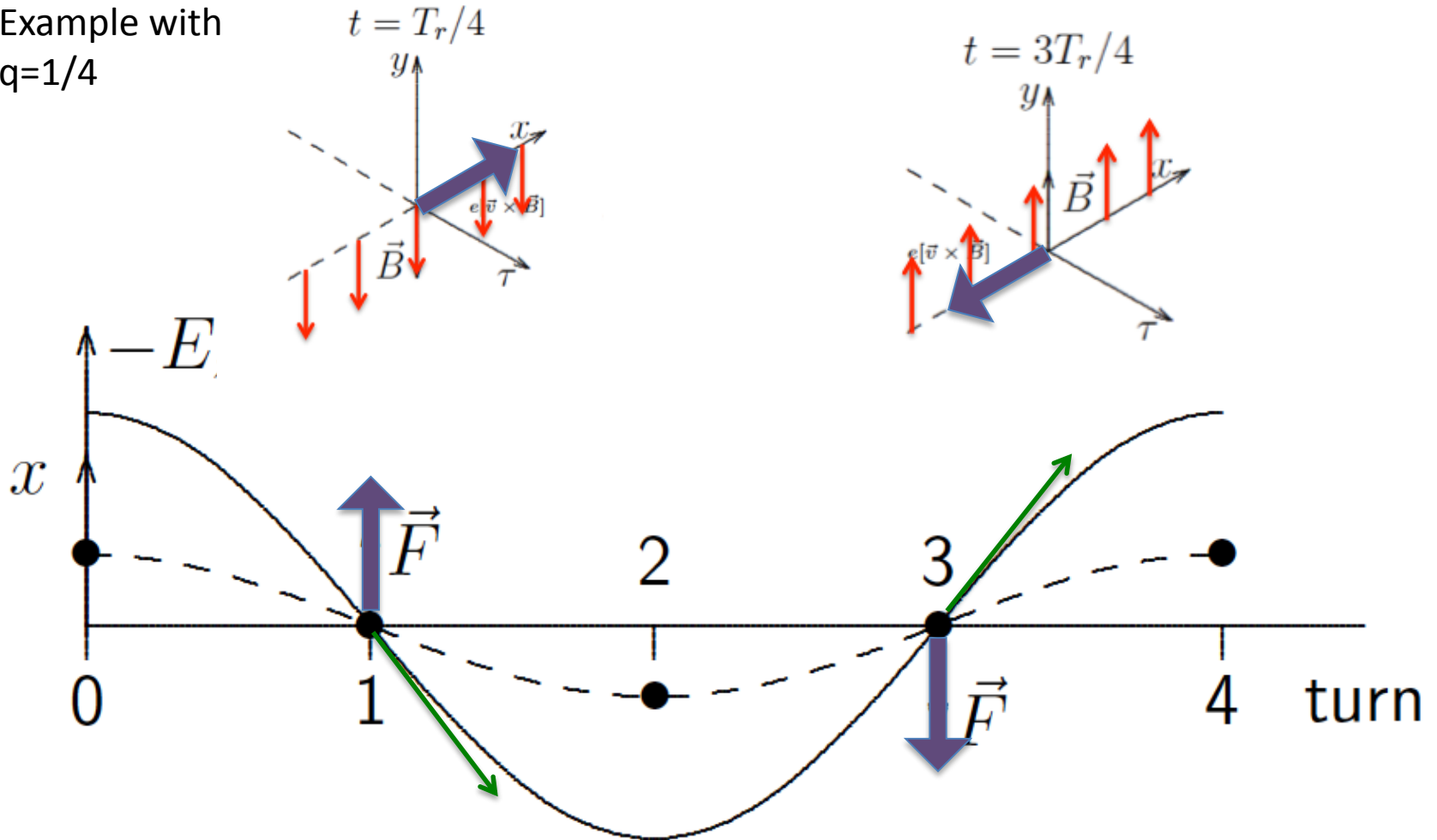

Cavity tuned upper sideband

Example with $q=1/4$

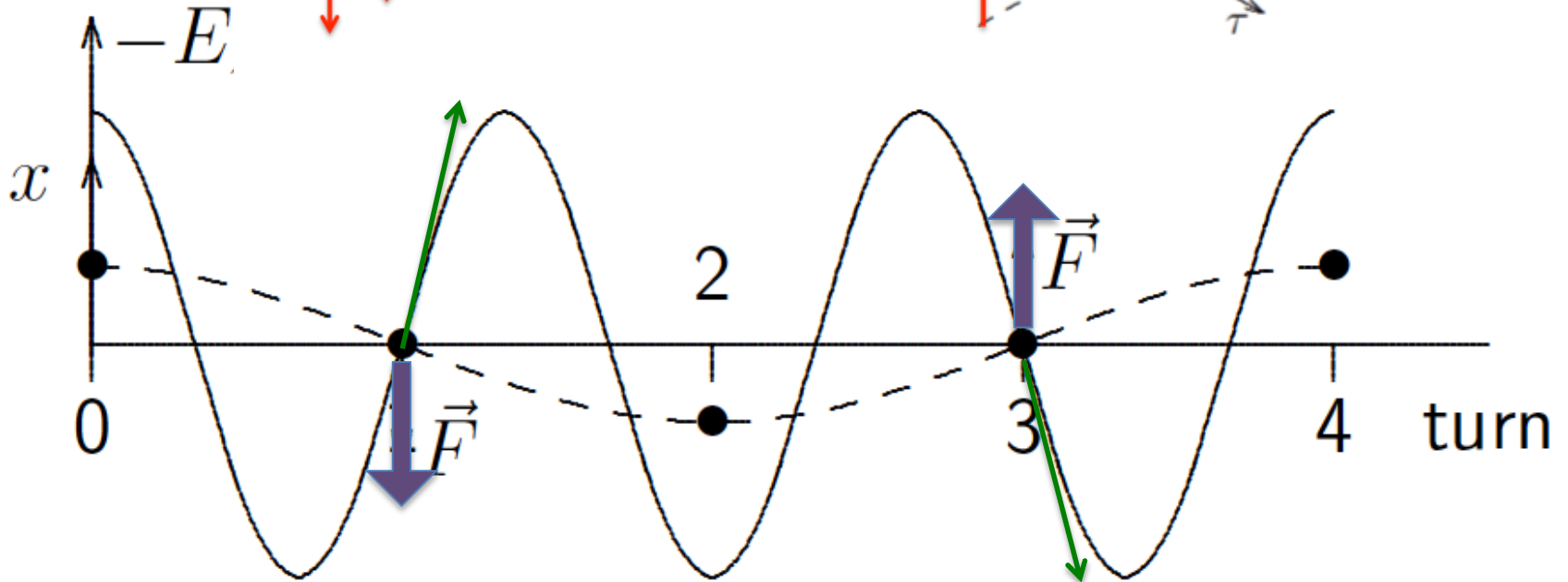
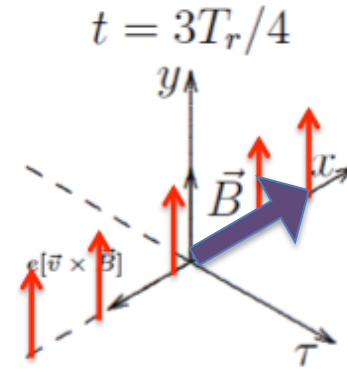
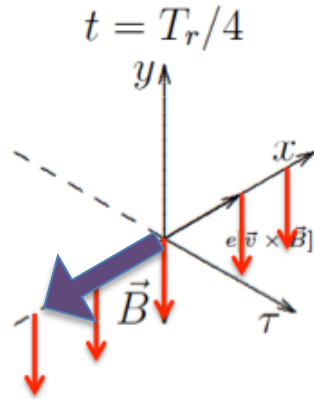

For chromaticity equal to zero, as for the Robinson Instability

$$\alpha_s = \frac{1}{\tau} \propto \sum_p I_p^2 [Z_{\perp}(\omega_p^+) - Z_{\perp}(\omega_p^-)]$$

Negative mass instability

Above transition

Example with
2 particles !

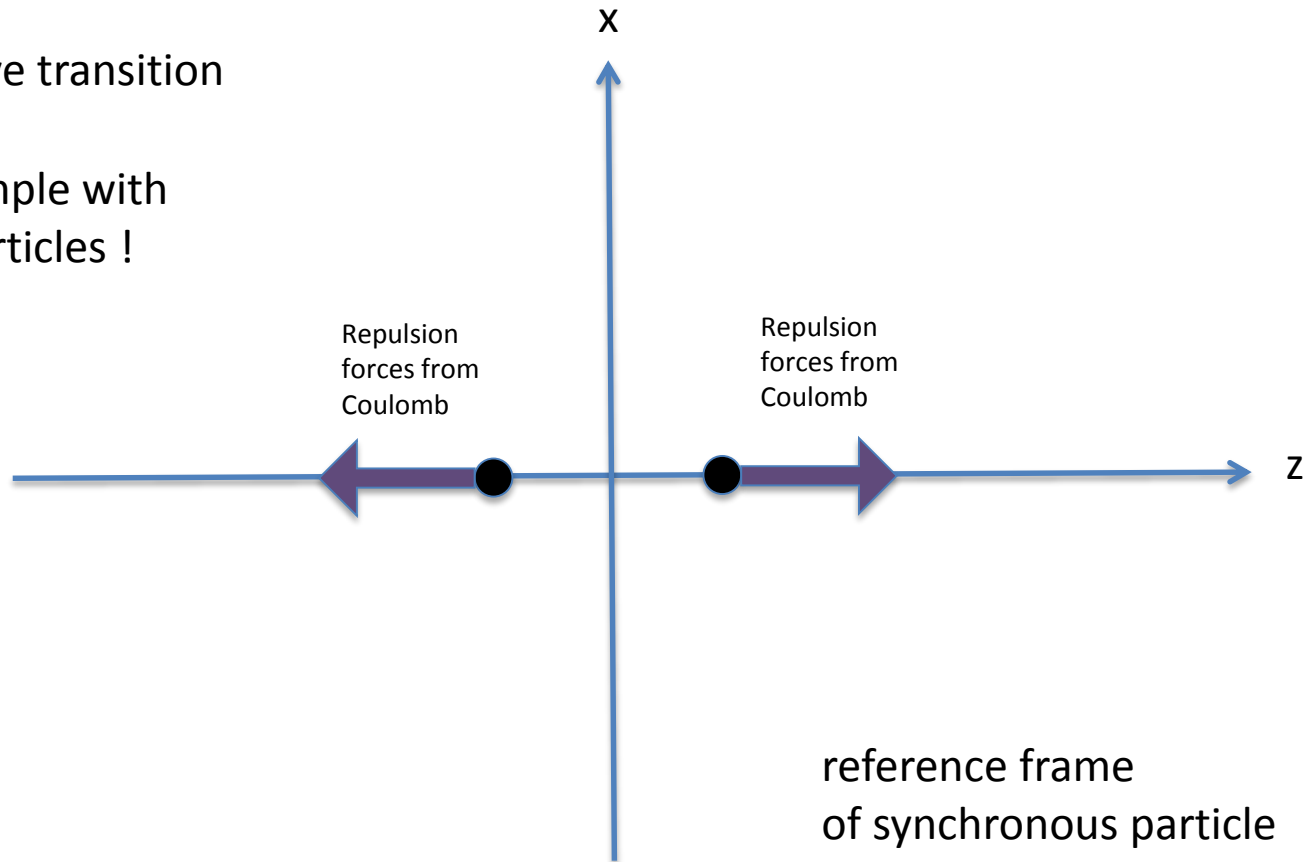

Negative mass instability

Above transition

Example with
2 particles !

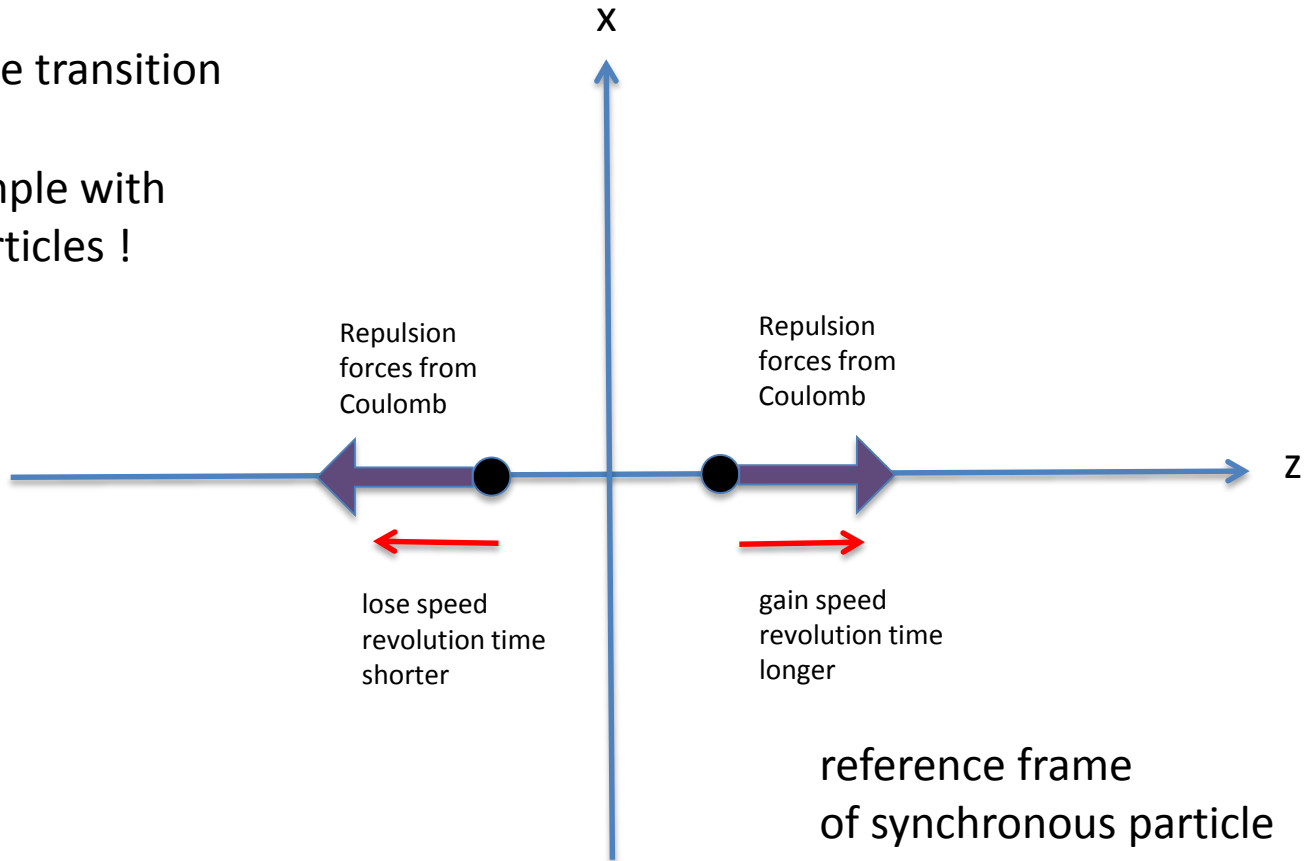

Negative mass instability

Above transition

Example with
2 particles !

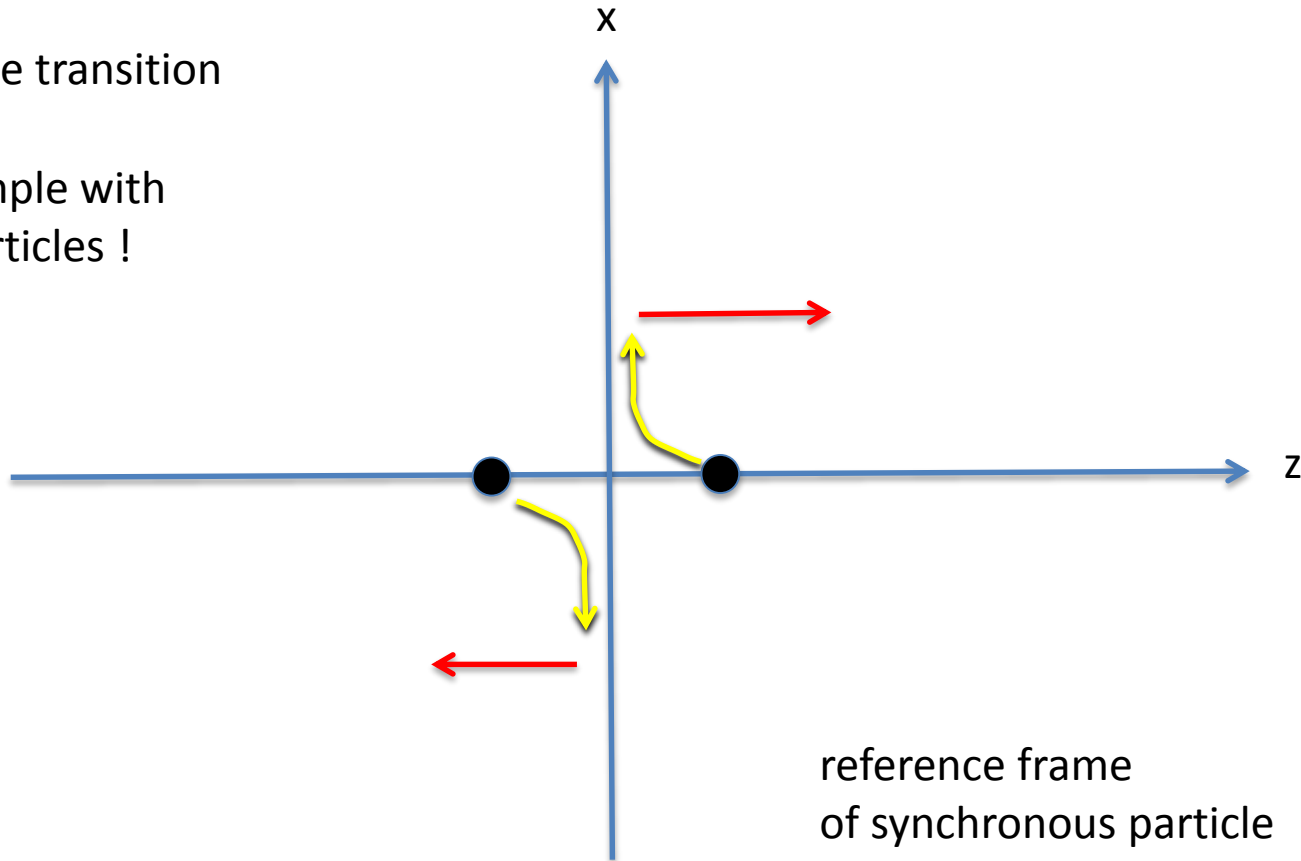

Negative mass instability

Above transition

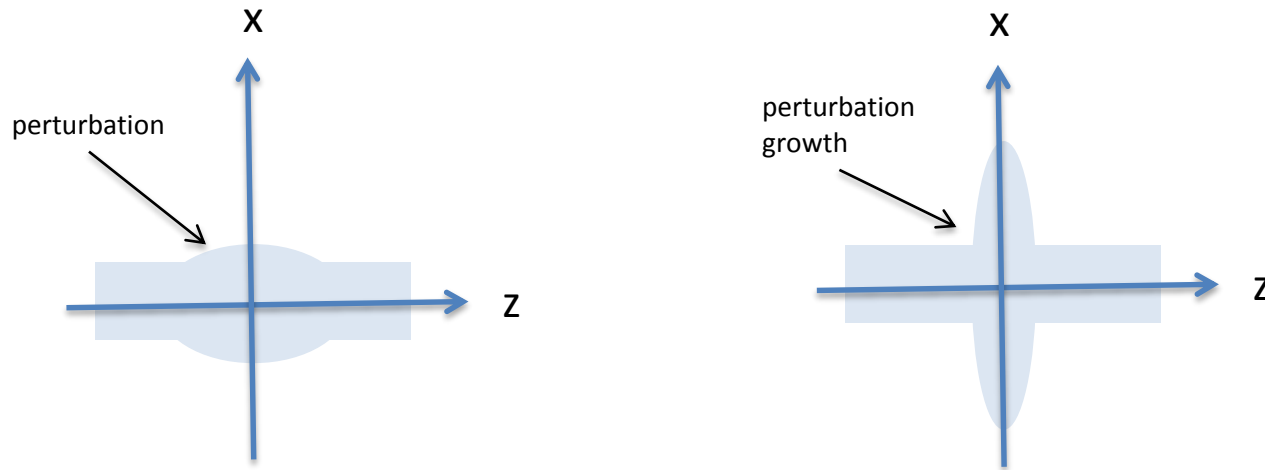

repulsive forces attract particles as if their mass were negative

$$\frac{1}{\tau_{\text{neg mass}}} = \frac{n\omega_0}{\beta c\gamma} \sqrt{\frac{q |\eta_c| c I_0 \left(1 + 2 \ln \frac{r_w}{r_0}\right)}{\beta E_0}}$$

Head Tail instability (fast)

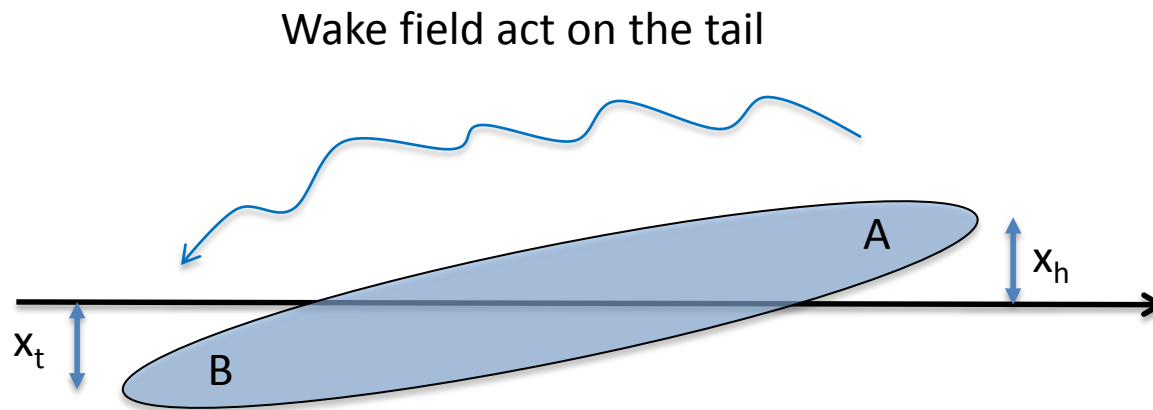

Effect is taken
linear



Head Tail instability (fast)

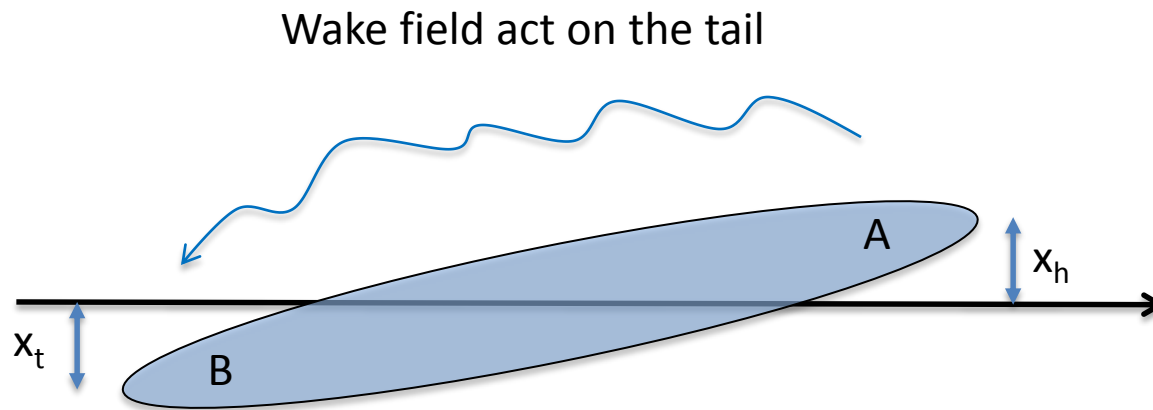

The tail makes betatron oscillation perturbed by the head

$$\ddot{x}_t + \omega_\beta^2 x_t = (\dots)x_h$$

Head Tail instability (fast)

After half synchrotron oscillation head and tail swap

Wake field act on the tail

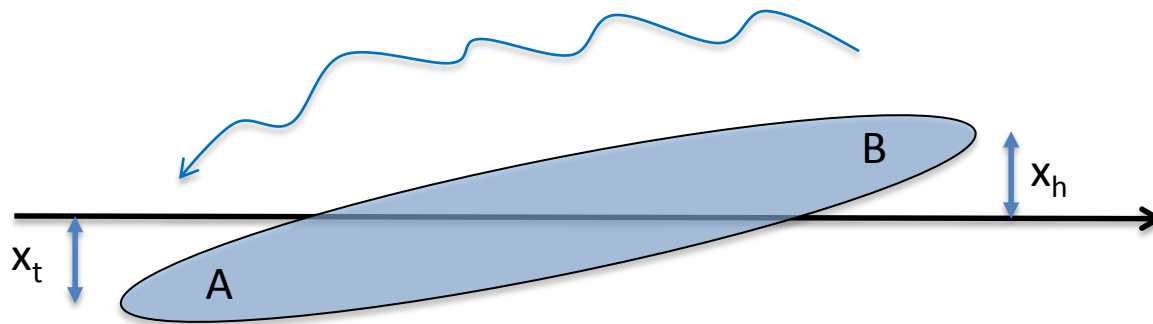

The tail makes betatron oscillation perturbed by the head

$$\ddot{x}_t + \omega_\beta^2 x_t = (\dots) x_h$$

Head Tail instability (fast)

In one synchrotron oscillations the situation is repeated

$$\begin{pmatrix} \mathbf{x}_1(t_s) \\ \mathbf{x}_2(t_s) \end{pmatrix} = e^{i\omega_\beta t_s} \begin{pmatrix} 1 - a^2 & -ia \\ -ia & 1 \end{pmatrix} \begin{pmatrix} \mathbf{x}_1(0) \\ \mathbf{x}_2(0) \end{pmatrix}$$

“a” is a quantity function of the wake potential

$$\text{Stability} \quad I_b \leq \frac{4\pi q \gamma \omega_0 \nu_\beta \nu_s}{r_c \beta c \operatorname{Im}\left\{\frac{Z_\perp}{n}\right\}}$$

Head Tail instability (fast)

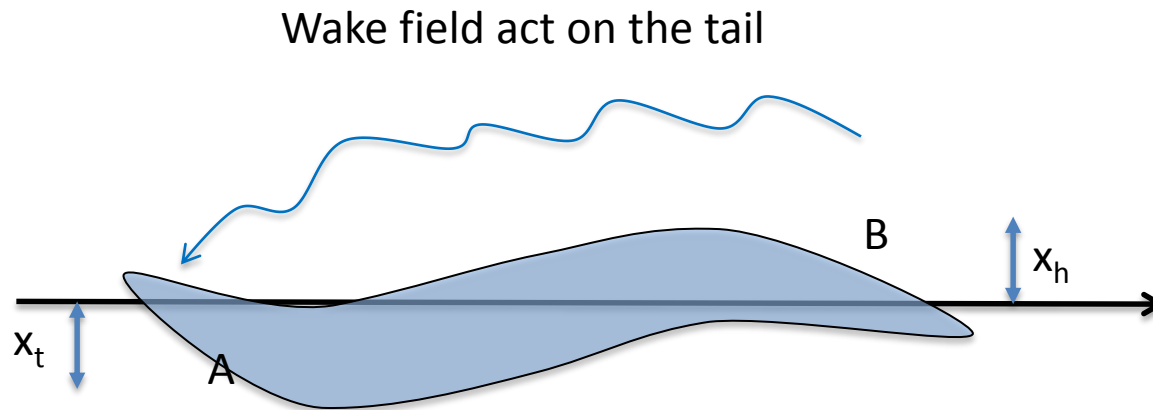

Summary

Robinson instability

Longitudinal space charge and resistive wall impedance

Transverse impedance

Transverse instability

Landau damping

Single bunch instability

Negative mass instability

Fast Head-Tail instability

References

Lectures of Albert Hofmann, CAS

Physics of collective beam instabilities in high energy accelerators - A.W. Chao, 1993

Theory and Design of Charged Particle Beams - M. Reiser, 1994

Particle Accelerator Physics - H. Wiedemann