

CERN ACCELERATOR SCHOOL 2012:

ELECTRON CYCLOTRON RESONANCE ION SOURCES - II

Thomas Thuillier
LPSC,

53 rue des Martyrs

38026 Grenoble cedex

France

E-mail: thuillier@lpsc.in2p3.fr



OUTLINE

- **Electron Cyclotron Resonance Ion Sources - 2**
 - **Evolution of Multicharged ECR Heavy Ion Source**
 - The pioneers – First generation (1970-1980)
 - Second generation (1980-2003)
 - Third Generation (2003...)
 - Prospects toward the Fourth Generation
 - **Ligh ECR Ion Sources Operated at 2.45 GHz**
 - **Techique to Improve Performance: Gas Mixing**
 - **Techniques to Produce Metallic Ion Beams**
 - **Basics of ECRIS Charge Breeding (1+/N+)**
 - **Pulse Mode Operation**
 - **Beam Extraction**
 - **Requirements for Beam Separation**
 - **Bibliography**
 - **Appendix**

The First Multicharged ECR Ion Source : SUPERMAFIOS 1975

- Invented at CEA Grenoble by R. Geller team (France)

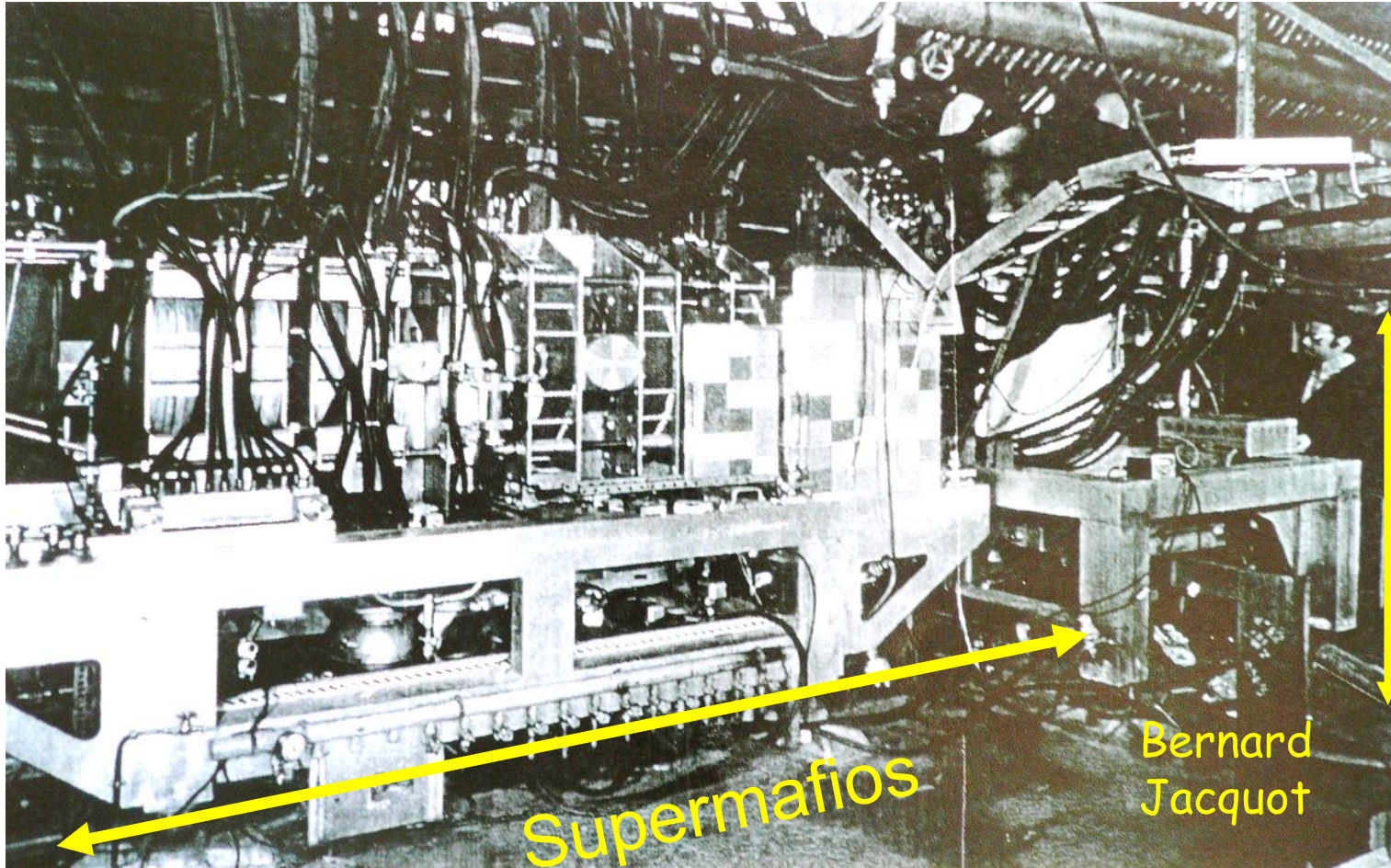

R. Geller

- A 3 MW modified fusion machine (CIRCE) to produce ion beams
- The legend says that, at first power switching, an electrical black out occurred on half of Grenoble city!

The First Multicharged ECRIS: SUPERMAFIOS

(1975)

- SUPERMAFIOS, a Two Stage ECR Ion Source

- The first ECRIS were very long ($\geq 1\text{m}$) and featured a complicated two stage ECR plasma
- Stage 1: high frequency, high pressure plasma in an axi-symmetric magnetic field to pre-ionize the atoms
- Plasma diffusion between stage 1 and stage 2 in a magnetic gradient
- Stage 2: main plasma heated at a lower frequency but in a large volume chamber equipped with a min-B structure (lofee bar hexapole + axial coils mirror) providing good confinement time for ions.
- The ion extraction was done very far away from the last magnetic mirror peak (never do that!)

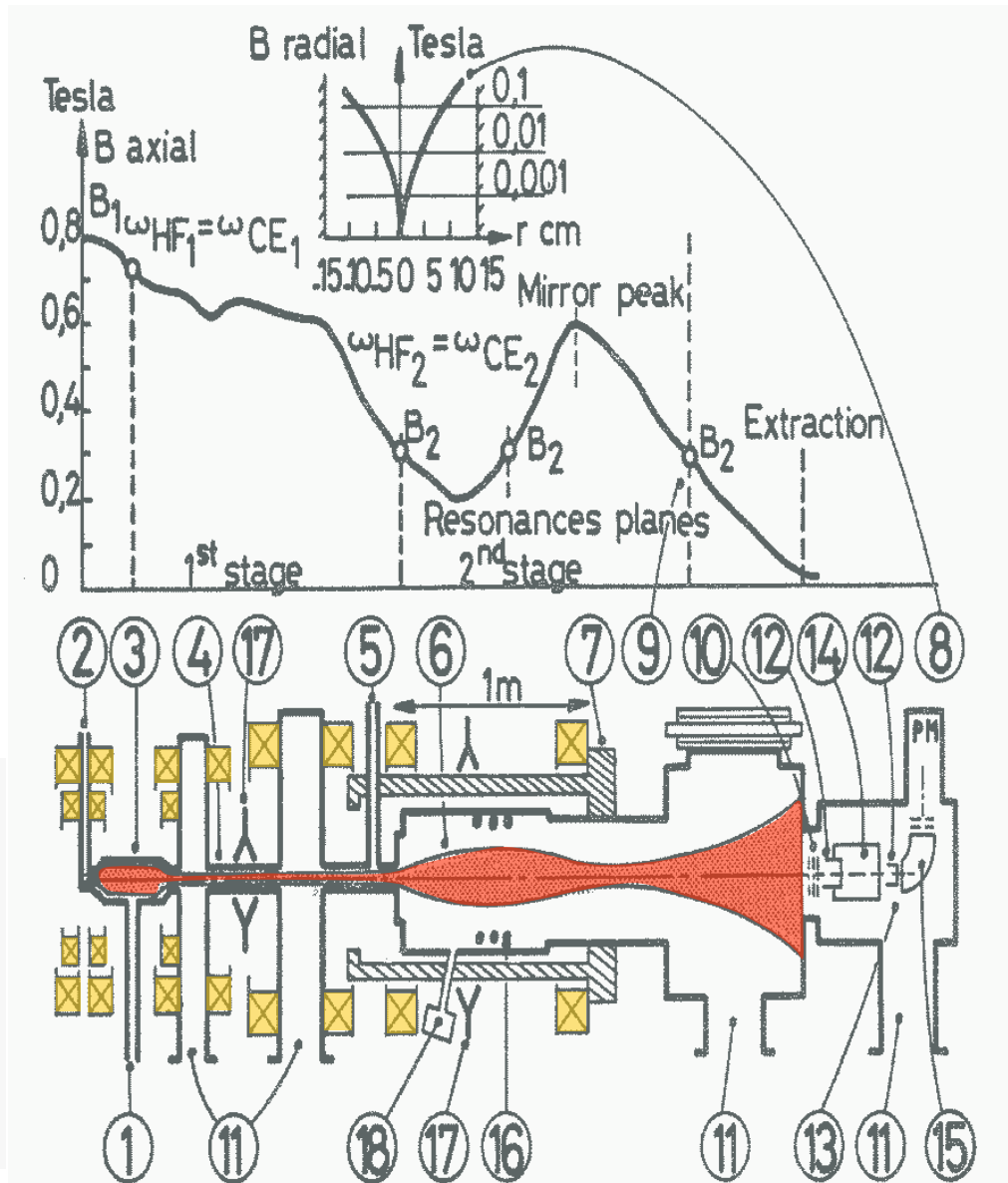

Fig. 1. 1) Gas injection; 2) Wave guide for RF_1 (16 GHz); 3) UHF cavity – source of plasma to be injected; 4) Diffusion zone; 5) Wave guide for RF_2 (8 GHz); 6) Accumulation zone for hot plasma; 7) Hexapole field coils; 8) Radial magnetic field; 9) Axial magnetic field; 10) Ion extraction; 11) Vacuum pumping; 12) Retractable faraday cup; 13) Ion abundance measurement; 14) Wien filter; 15) Energy analyzer; 16) Diamagnetic loop; 17) Microwave 8 mm interferometer for density measurements; 18) Beryllium window for X ray measurements.

The 70 & 80's Pioneers – First Generation Ion Sources

- MINIMAFIOS – ECREVIS– LBL ECR ...

ECREVIS

Louvain la Neuve

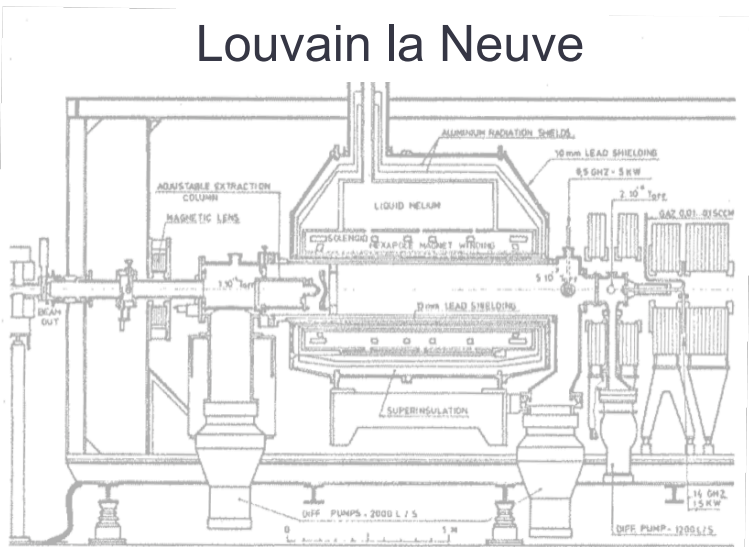

MINIMAFIOS CEA Grenoble

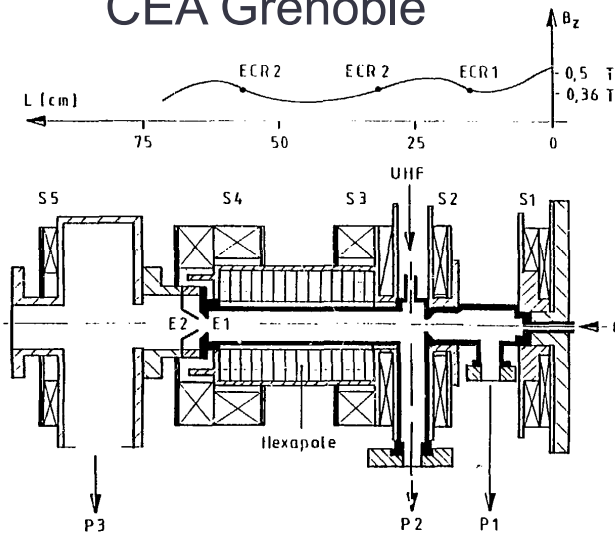

LBL ECR

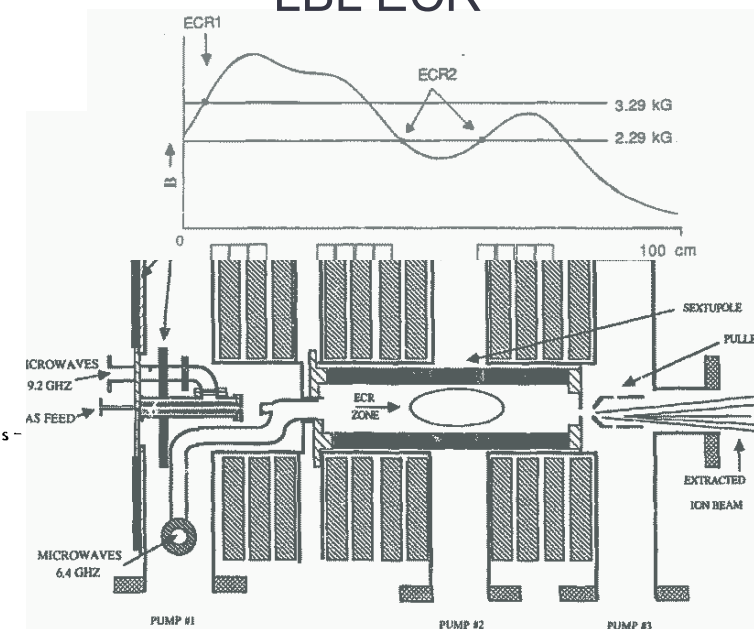

The First ECR beam in
A cyclotron was
achieved at Louvain
La Neuve (B)



First Generation ECRIS performances

- International competition for results was already there!
- First International Workshop on Ion sources in

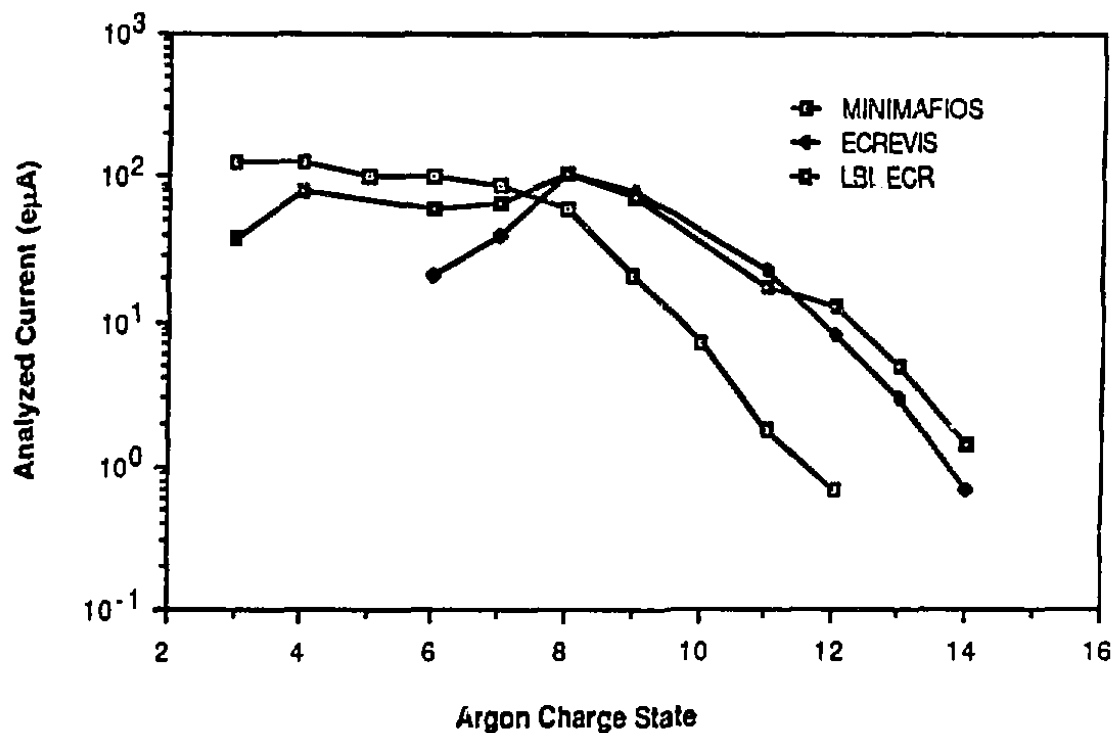

Typical beam performance of G1:

~100 $\mu\text{A Ar}^{8+}$

~100 $\mu\text{A O}^{6+}$

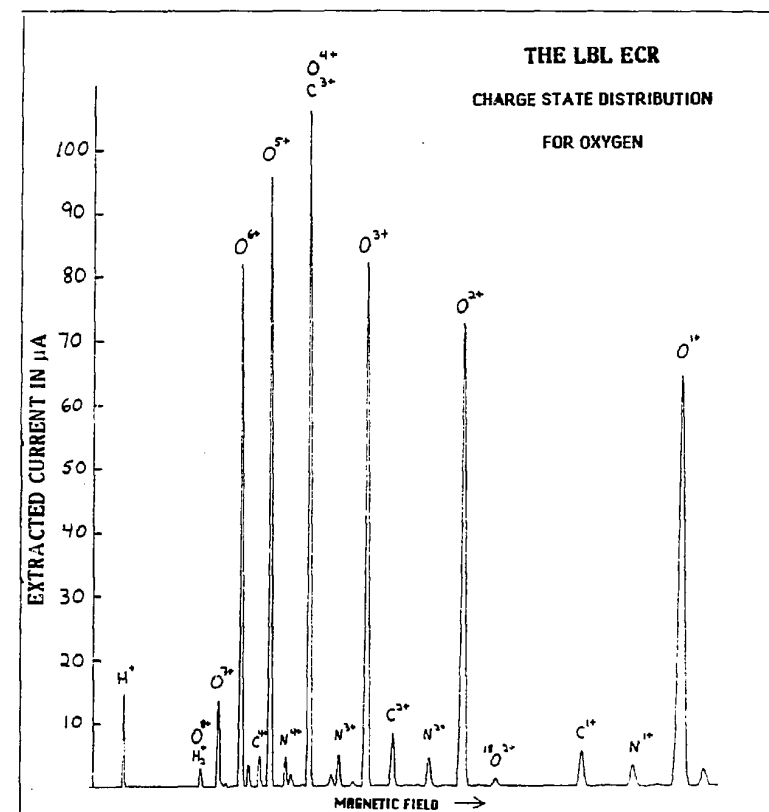

Second Generation ECRIS

- Generalization of ECRIS used as cyclotron injectors or low energy atomic physics facility in the 80's and the 90's
 - Dramatic increase of plasma performance by improving the know-how in RF injection, magnetic confinement and ion beam extraction
 - The first plasma stage is abandoned => simplification of the design
 - It is the time for more compact and economical ion source using permanent magnets for hexapole
 - Numerous nuclear physics results obtained thanks to ECR Ion Sources



*Superconducting ECRIS

Example of ECR4, GANIL (1989)

- $f=14.5$ GHz-1.5 kW ($B_{\text{ECR}}=0.64$ T)
- Coaxial RF coupling from a cube located outside the source, equipped with a movable rod (not shown) able to adapt RF impedance to the ECR cavity, inherited from CAPRICE source design.
- Axial Mirror: 1.04 T – 0.35 T – 0.8 T
- Hexapole: 1 T FeNdB HallBach type
- Typical Ion Beam: ~ 650 μA Ar^{8+}
- Chamber volume ($\text{\O}64$ mm \times L200 mm) $V\sim 0.5$ liter

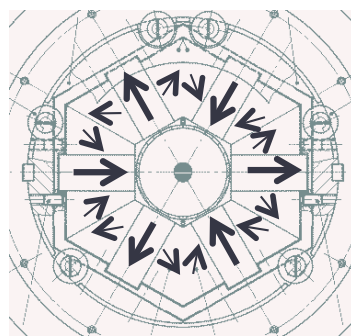
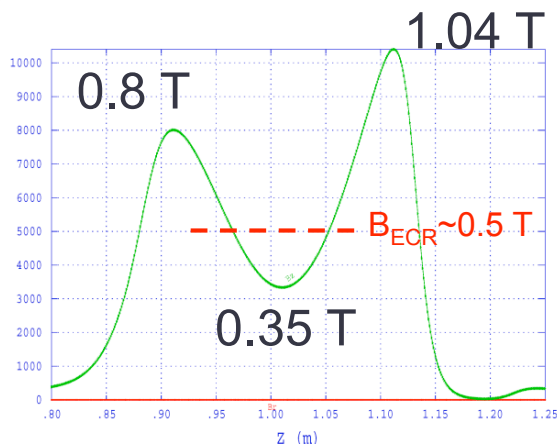
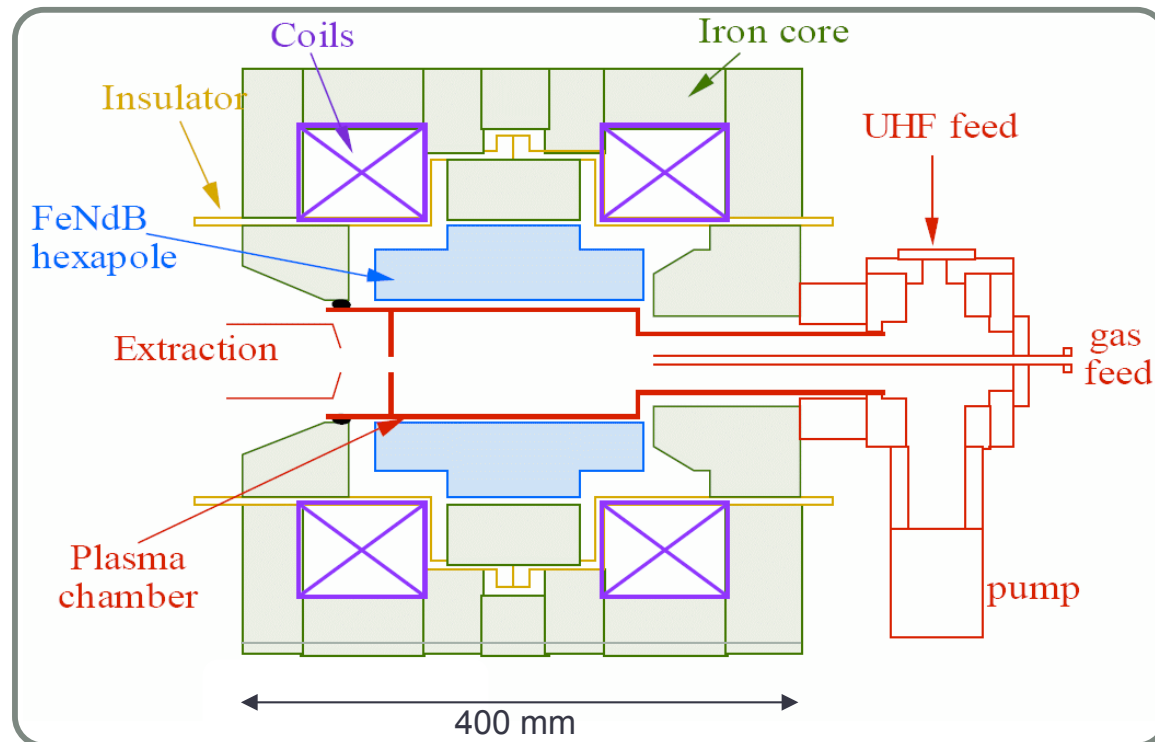

FeNdB hexapole

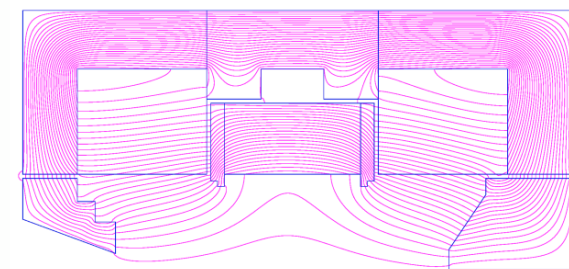
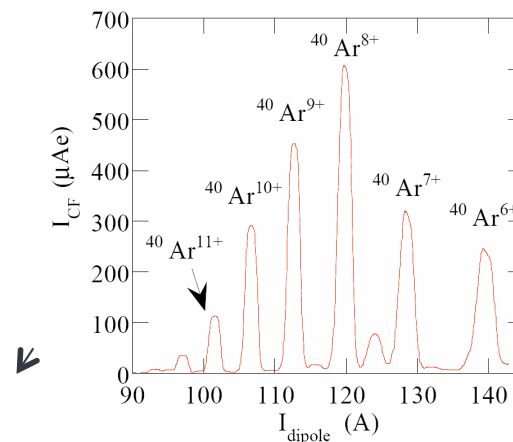

Axial Magnetic field lines (ECR4M)

AECR-U LBNL(1996) (upgrade of A-ECR 1990)

- Introduction of double frequency heating (+10-20% beam)
 - $f=10+14$ GHz / 2 kW
- Volume ($\varnothing=76$ mm, $L=30$ cm) $V\sim 1.36$ liter
- Hexapole with **radial slots access** between poles for pumping.
- Iron Plug at injection to boost injection field to 1.7 T
- Bias disk to boost charge states (see picture next slide)
- Aluminum plasma chamber (higher charge state)
- Axial field 1.7-0.5-1.1 T
- Radial Field 0.85 T
- Movable extraction system
- Typical beam $840 \mu\text{A O}^{6+}$, $120 \mu\text{A Ar}^{13+}$

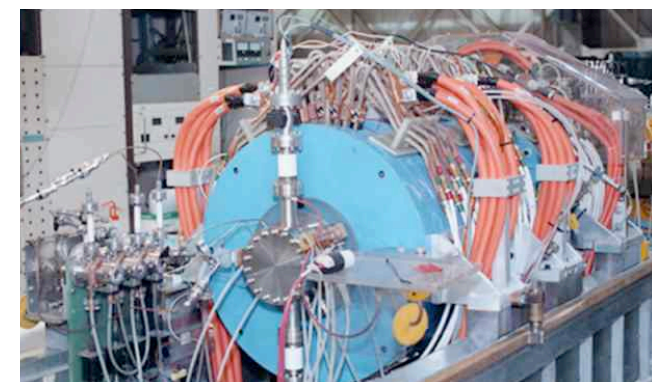
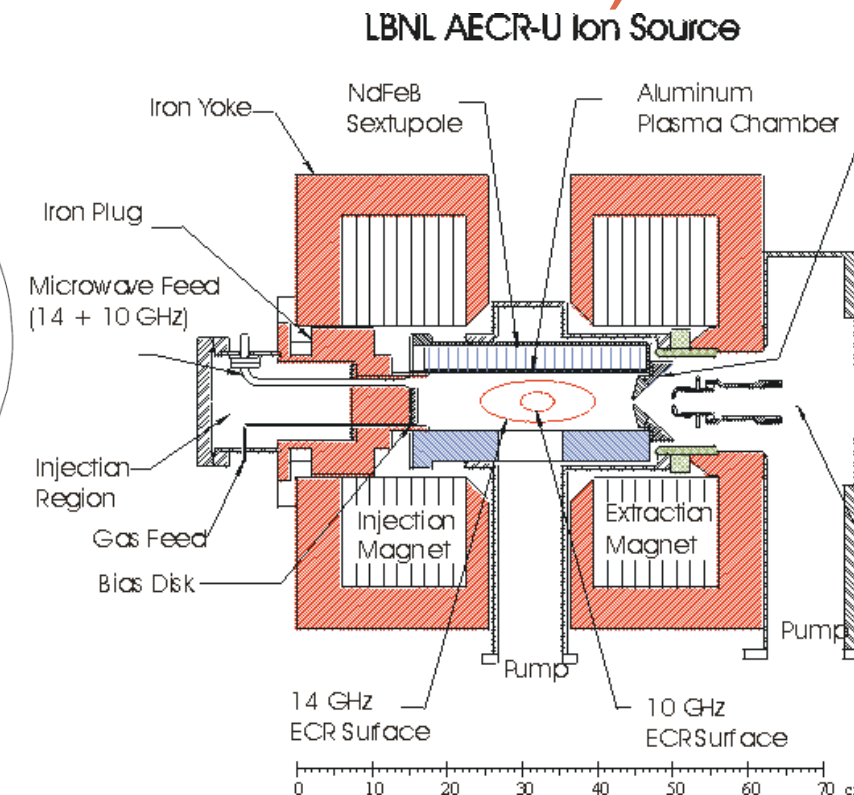
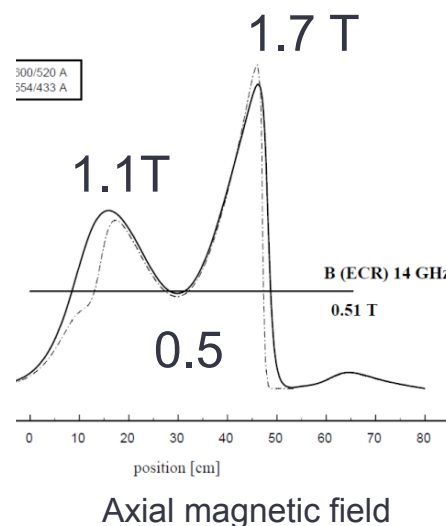
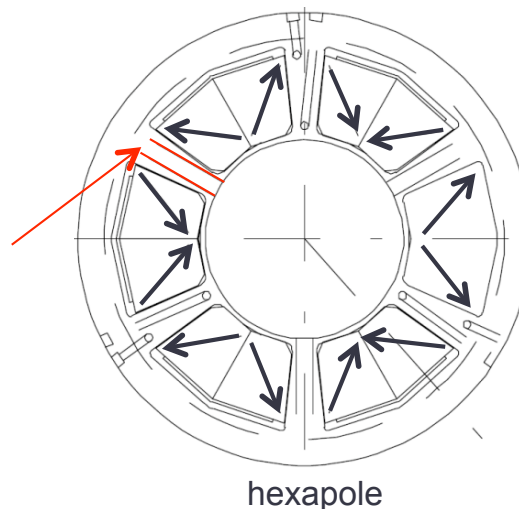

A 18 GHz Modern ECRIS: PHOENIX V2, LPSC/SPIRAL2 (2004)

- $f=18$ GHz- 2 kW ($B_{\text{ECR}}=0.64$ T)
- Direct Wave guide coupling
- 3 room temperature coils to tune more efficiently the plasma (central in opposition)
- Optimised Hexapole: 1.35 T FeNdB, 2 layers
- Axial Mirror: 2-0.5-1.25 T
- Chamber Volume ~ 0.6 liter
- Typical beam 1.3 mA O^{6+} ; 20 μA Ni^{19+}

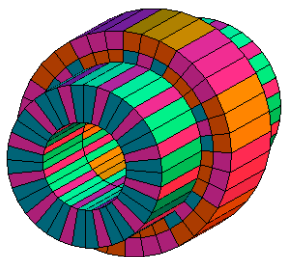
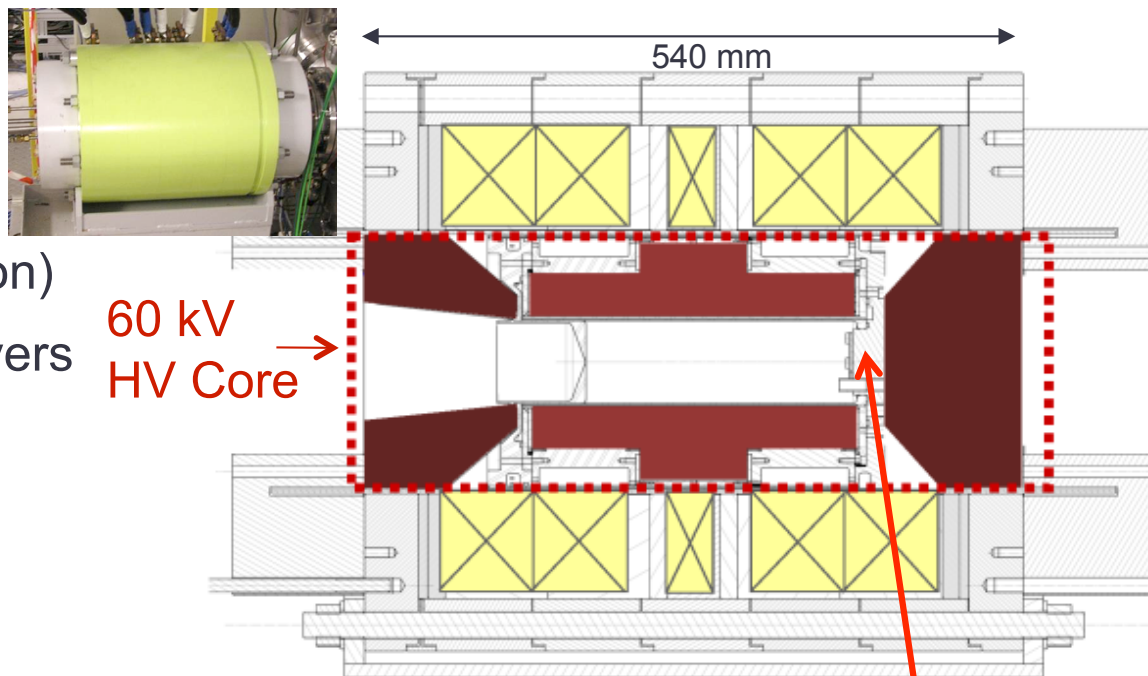

Optimized hexapole

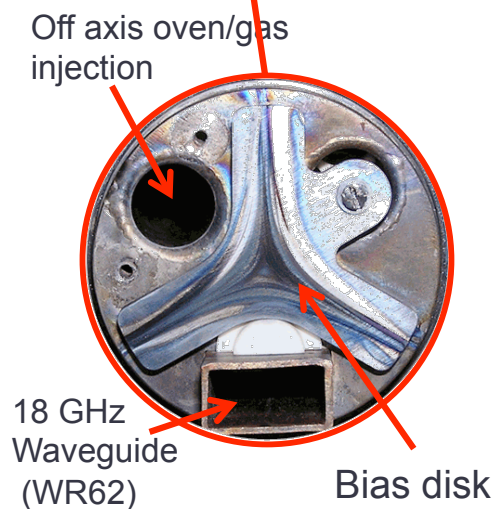
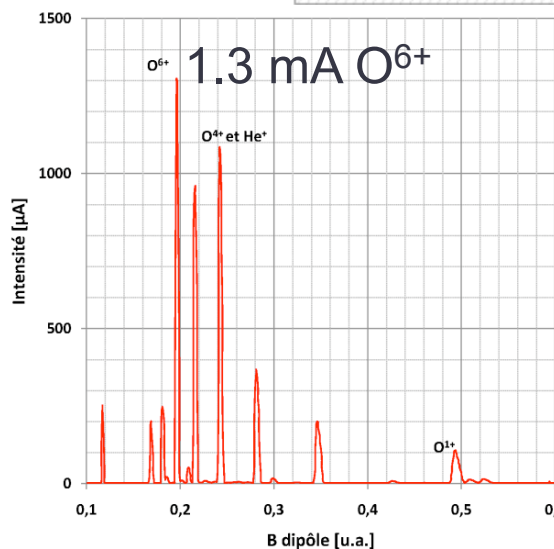
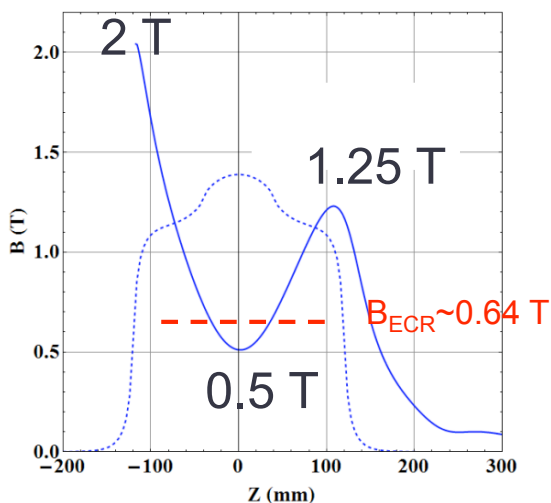

Third Generation ECR Ion Sources

- The new high performance ECR ion sources are optimized for ECR frequency $18 < f < 28$ GHz
- The high magnetic field intensity required to confine the plasma ($\sim 2-4 \times B_{\text{ECR}} \sim 2-4$) makes the use of copper coil technology unreasonable in term of electrical power consumption (2T hexapole in Cu technology \Rightarrow 3-4 MW electrical power).
- New ECRIS are preferably fully superconducting, with a large plasma volume to produce very high charge states for Cyclotrons or High intensity LINAC
- The beam current dramatically increases when the source is operated at higher frequency, and new technical challenges have arisen....



*Superconducting ECRIS

the first 28 GHz ECRIS VENUS, LBNL (2002)

- $f=18+28$ GHz - (2+6) kW
- $B_{\text{ECR}}=1$ T
- Fully superconducting ECRIS
 - NbTi:Cu wire technology
 - 4K LHe + thermal 40 K shield
 - 4x1.4 W cryocooling
- Axial profile 3.5-0.35-2.2 T
- Radial hexapole at wall $B_r=2.2$ T
- Dedicated to very high intensity, very high charge state applied to cyclotron acceleration
- Plasma Chamber volume $V\sim 8.5$ liter
 - $\varnothing\sim 15$ cm , $L\sim 50$ cm
- $V\sim 25$ kV
- Typical beams: 3 mA O^{6+} , 0.86 mA Ar^{12+}

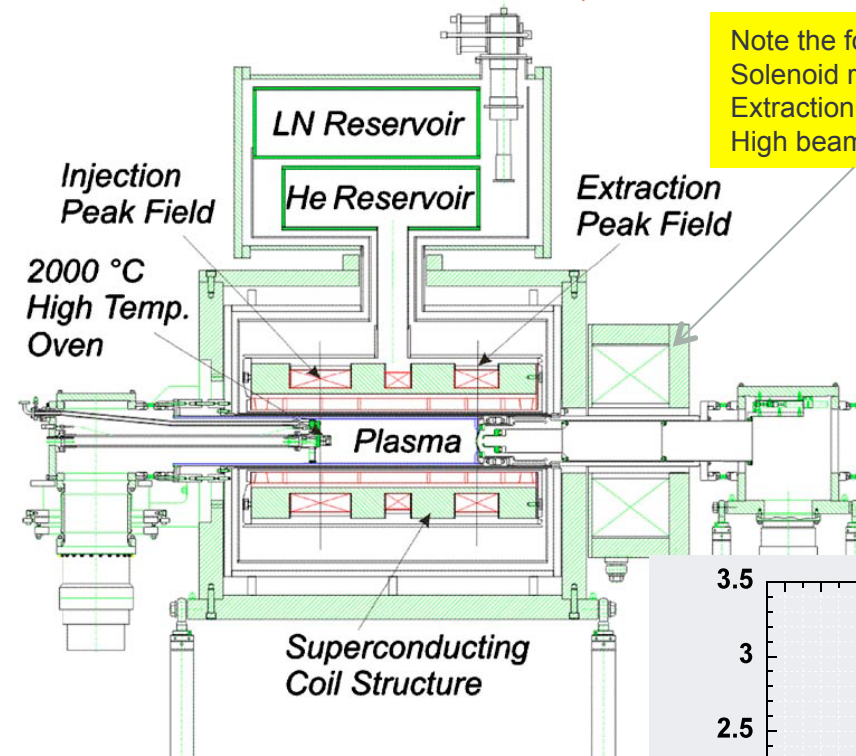

Note the focusing Solenoid right at the Extraction to manage High beam current

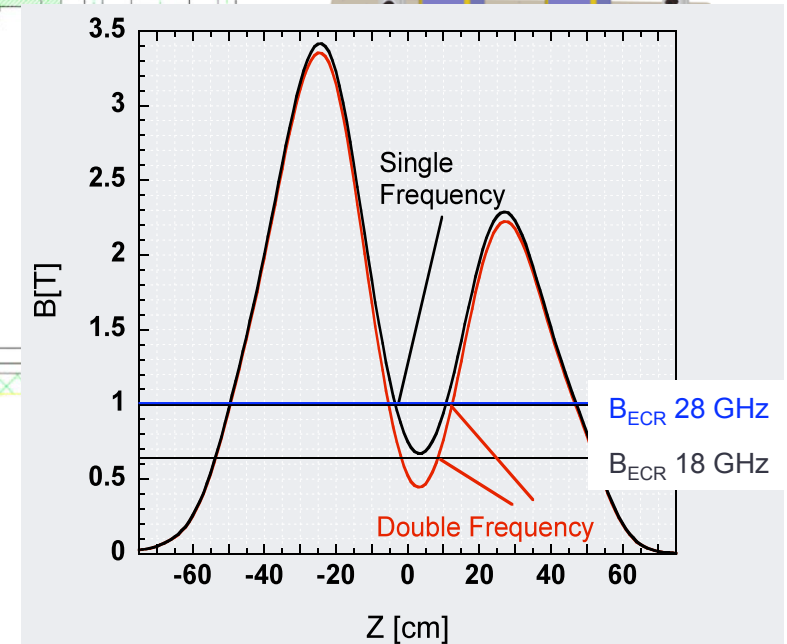
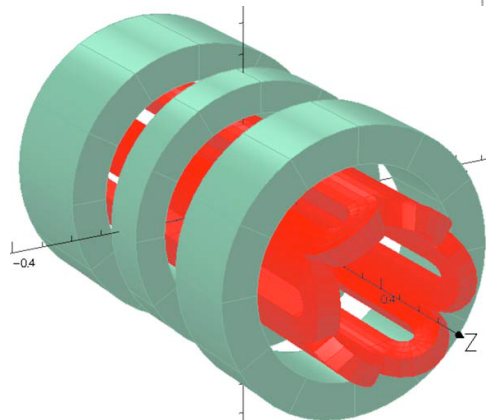
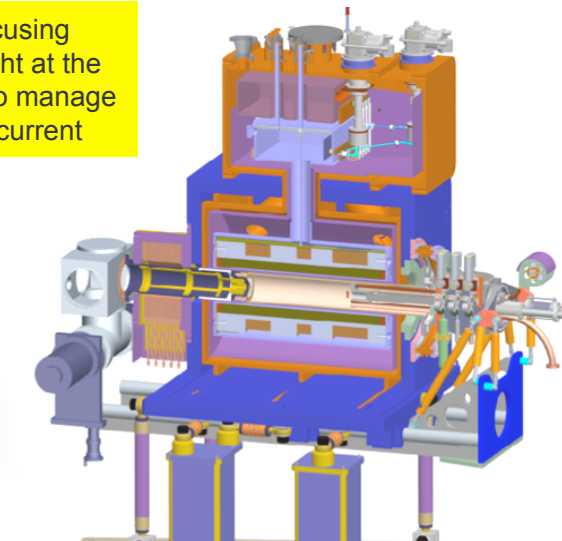

VENUS Performances – example of ion spectrums

- High intensity, high charge state ion spectrums

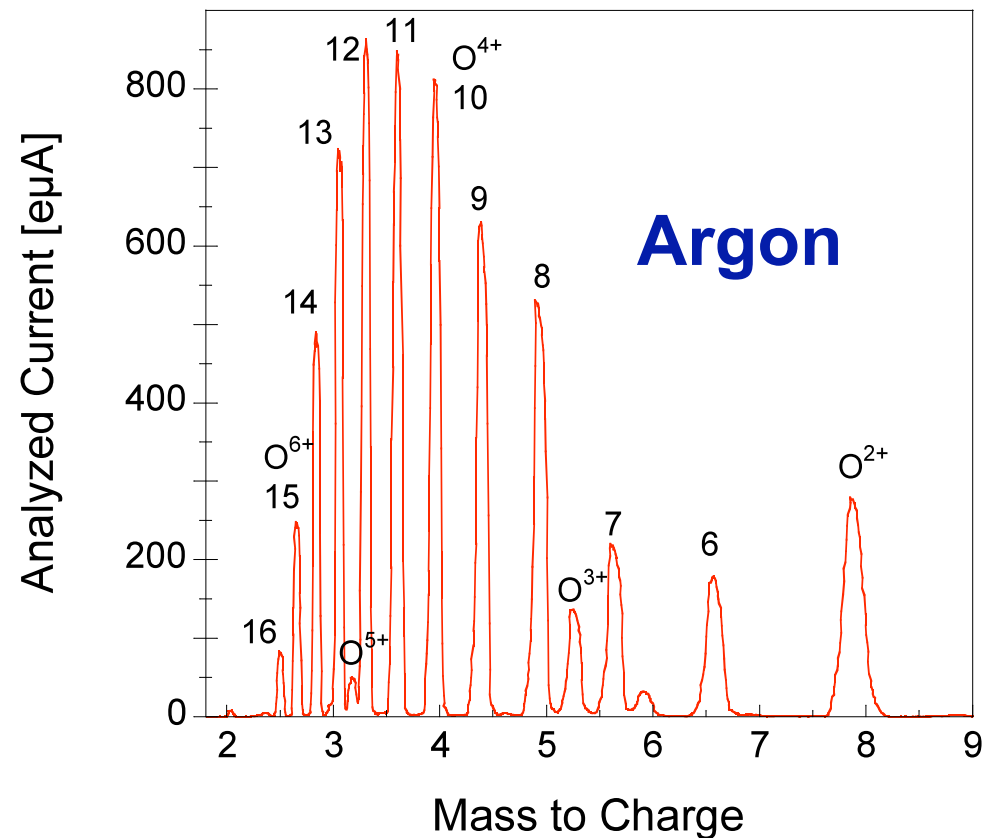
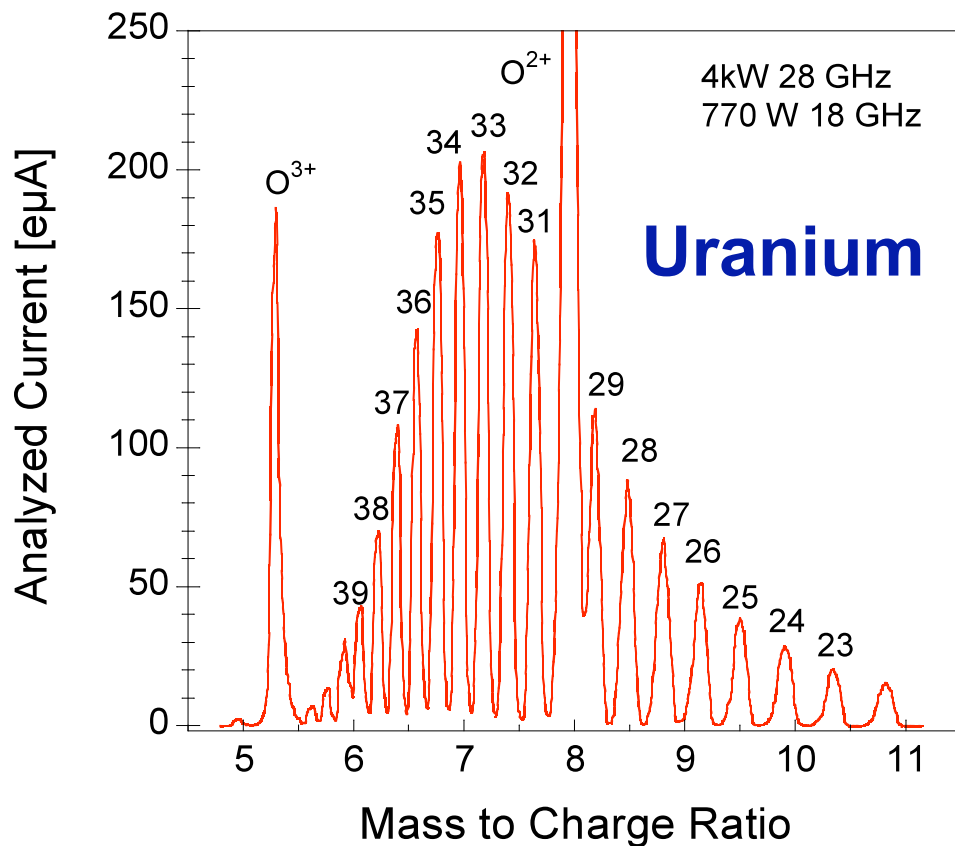

Source: D.Leitner, LBNL, 2007

SECRAL 24 GHz (IMP CAS, Lanzhou)

- Fully Superconducting ECRIS (2004)
- Original design hexapole outside the axial coils
 - Magnetic intensity boosted by large iron yoke around the large hexapole
- $f=18+24$ GHz / $((1.7+1.8)+7)$ kW
- $B_{rad}=1.8$ T
- Axial Field 3.7-0.82-2.2 T
- $\varnothing 120$ mm, L 42 cm ; V~4.7 liter
- Typ. beam: 2.3 mA O6+ ; 510 μ A Ar12+

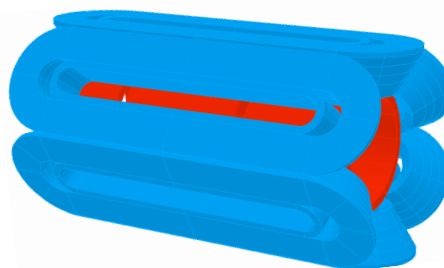

SC Hexapole outside The solenoids

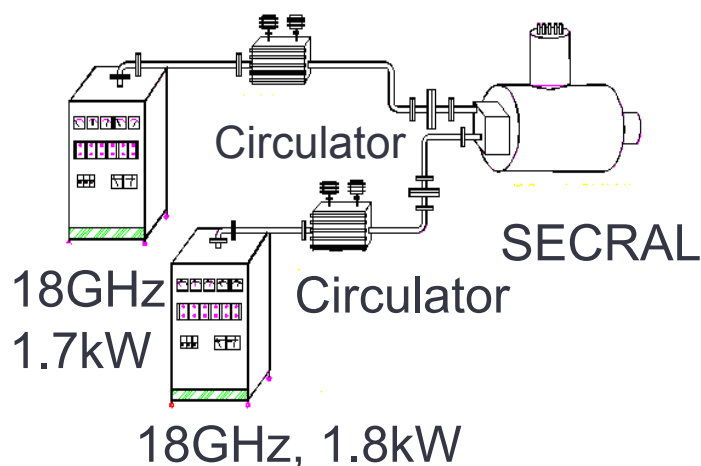
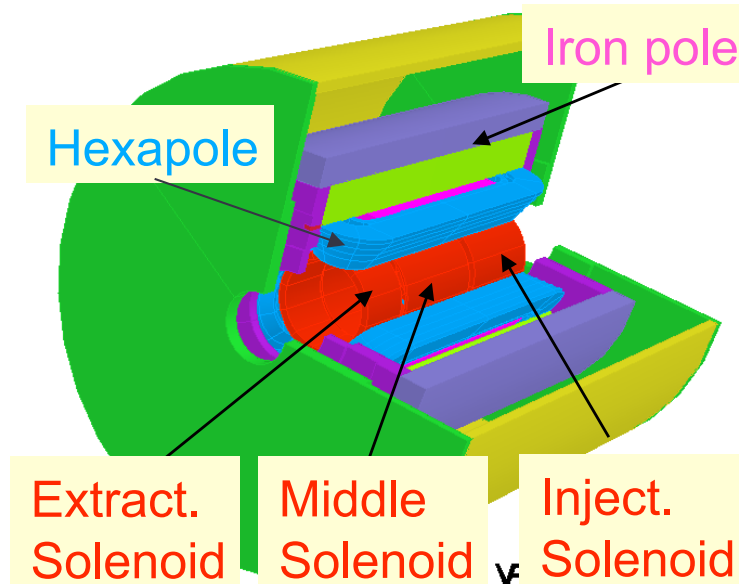

Sum of 2 x 18 GHz Klystron power

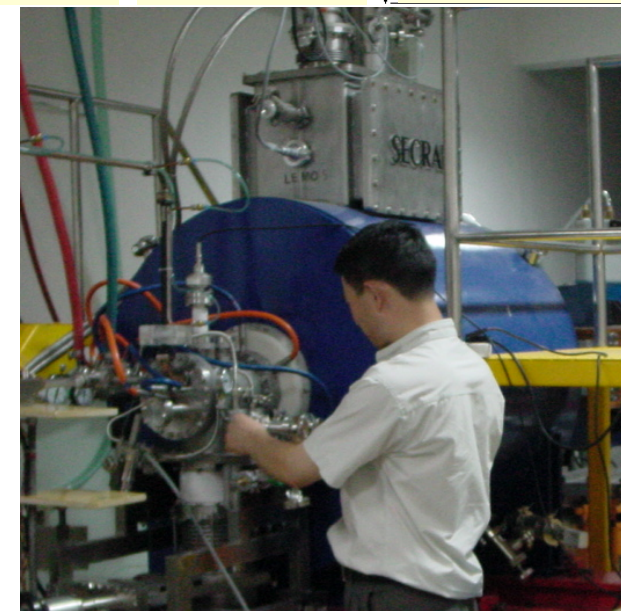
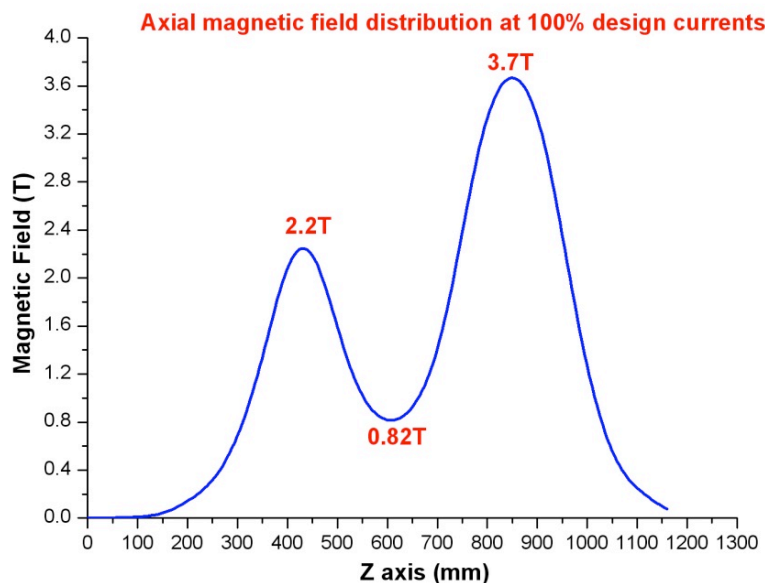

SECRAL Mechanics

- Uses of all the up to date techniques
 - Note the large pumping to work at low pressure, improve charge state and reduce background

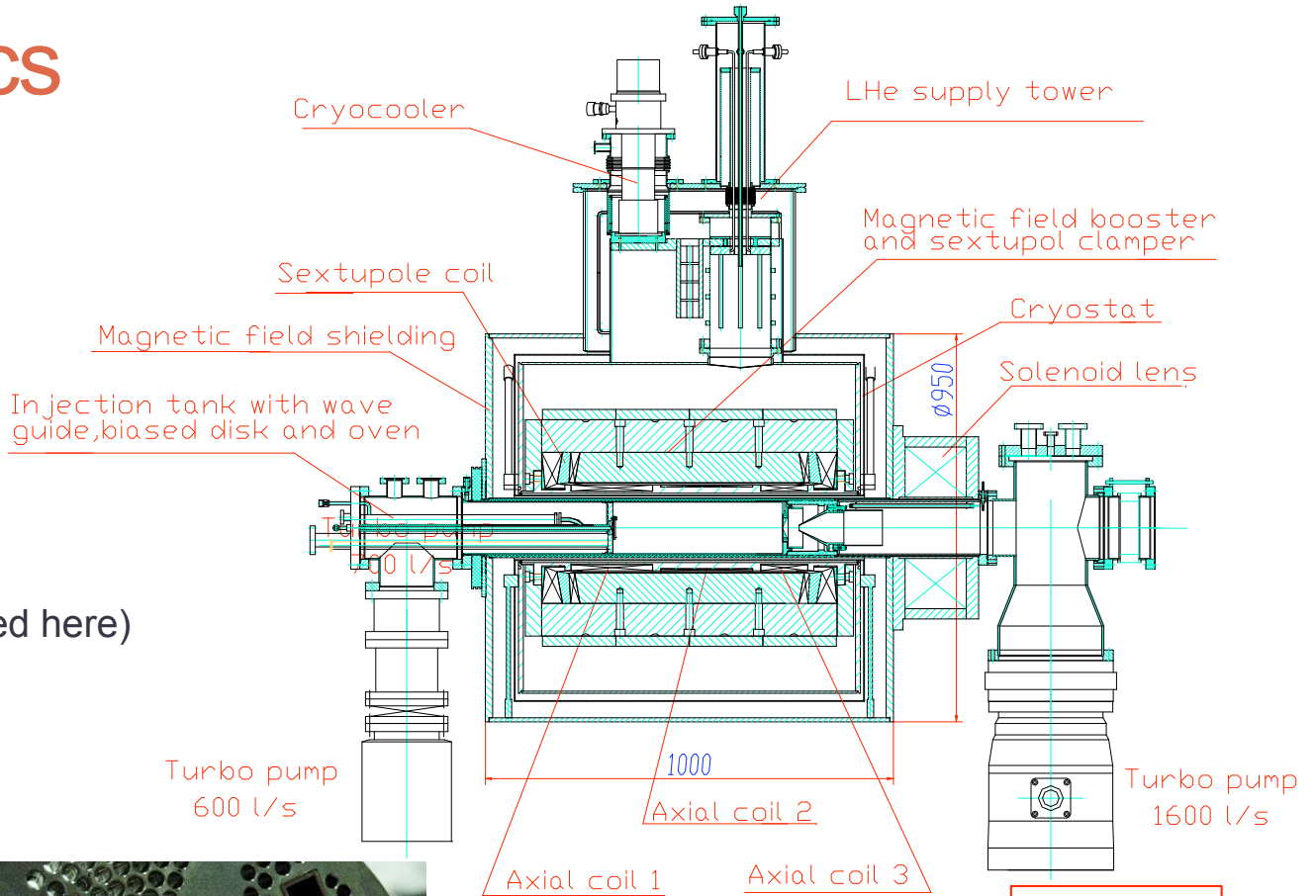

Bias Disk
High Temperature Oven
18 GHz injection
24 GHz Port (unused here)

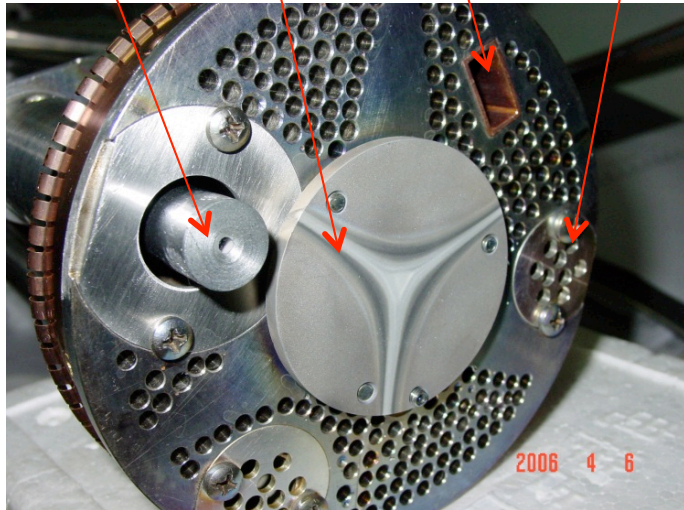

Removable UHV Injection system

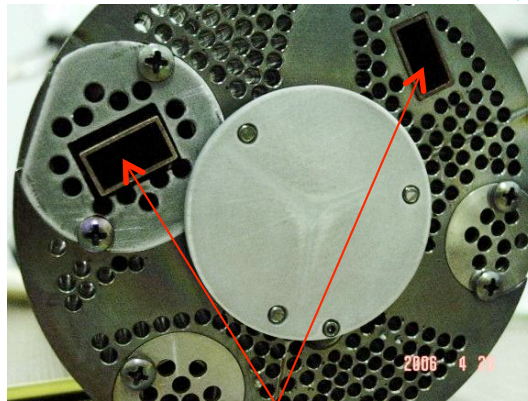

Double 18 GHz Injection here



Removable UHV Injection system with 18+24 GHz

SECRAL – typical Beam performance

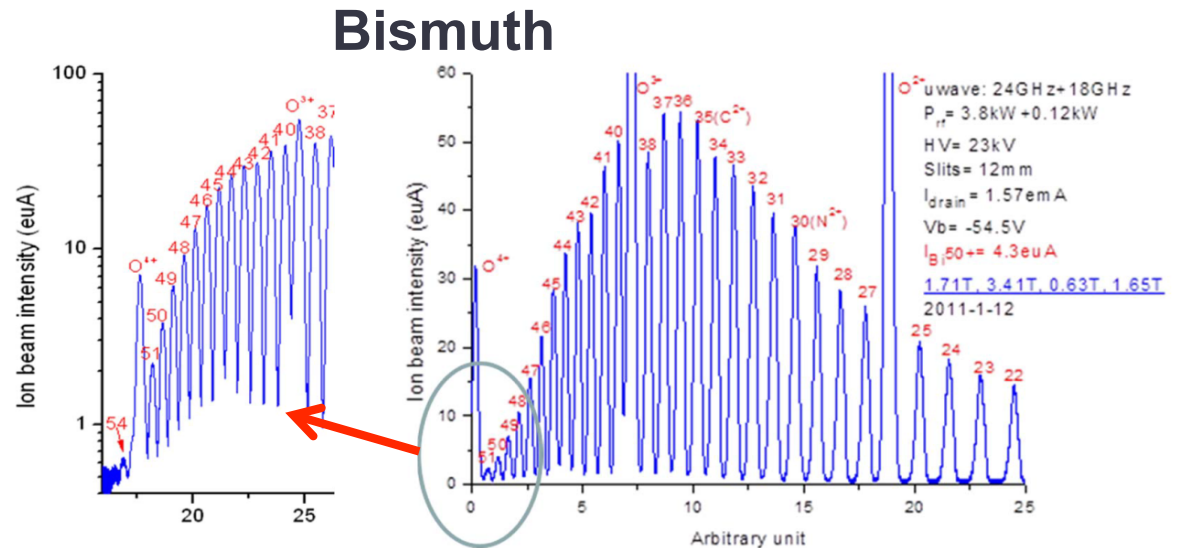
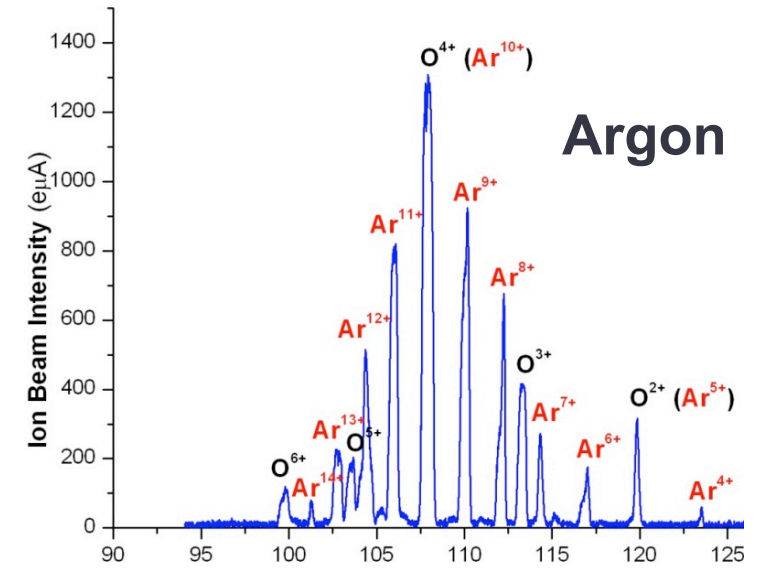
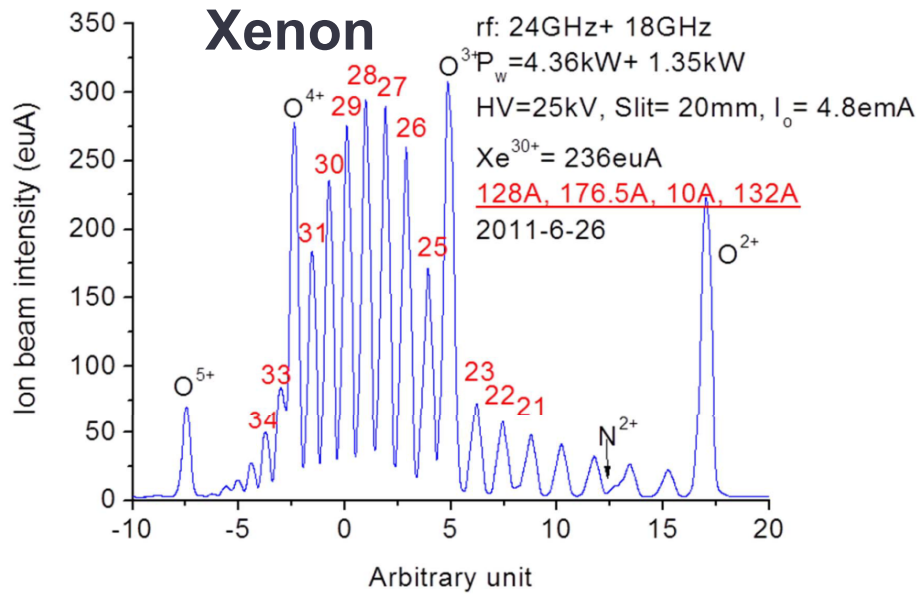

Example of Today High Charge state production

- Today ECRIS Argon beam performance

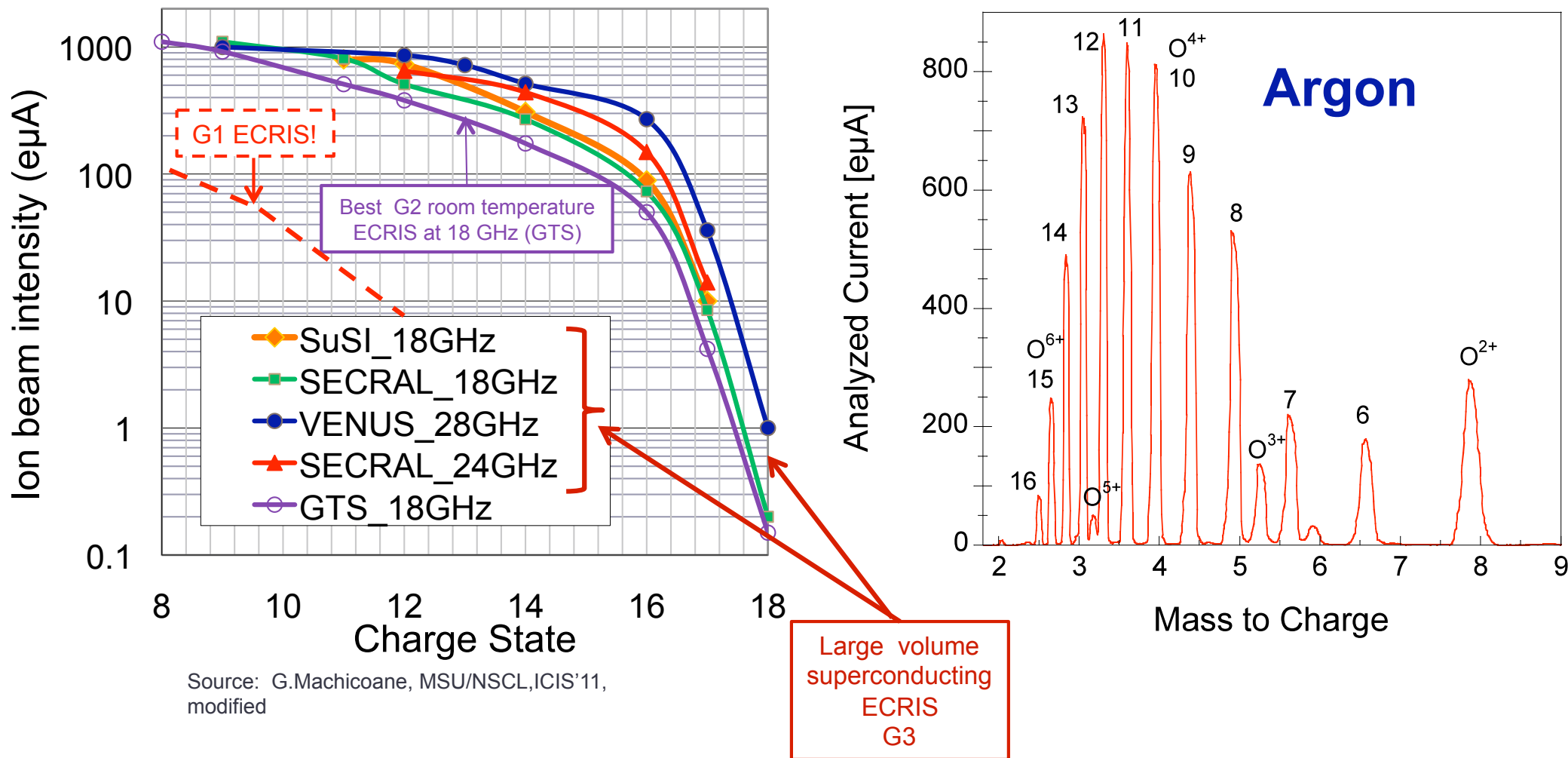

ECRIS prospects – Accelerators demands

- Many new accelerator projects are requiring high intensity, high charge state ion beams → Condition to start 4th Generation ECRIS R&D are met

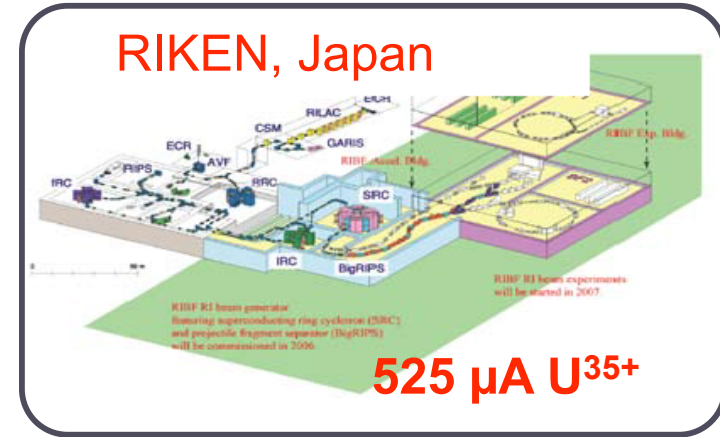
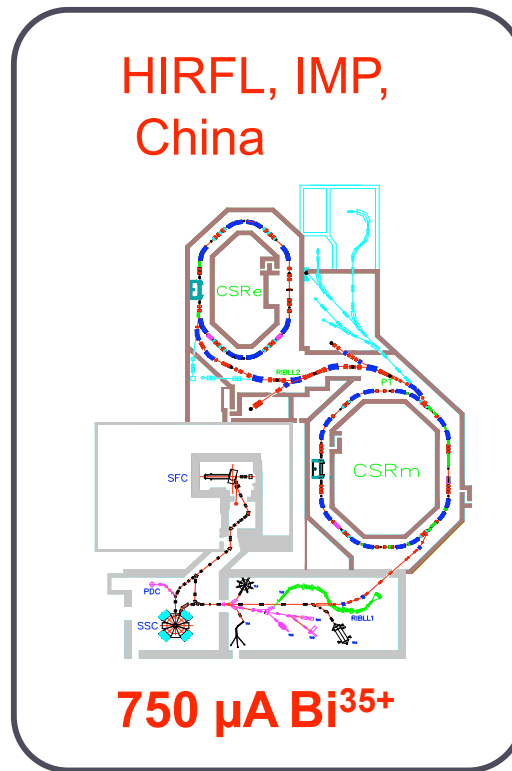
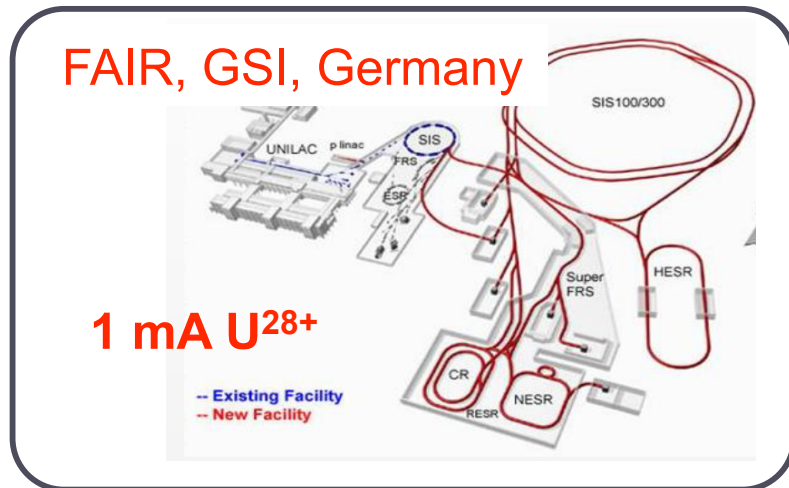
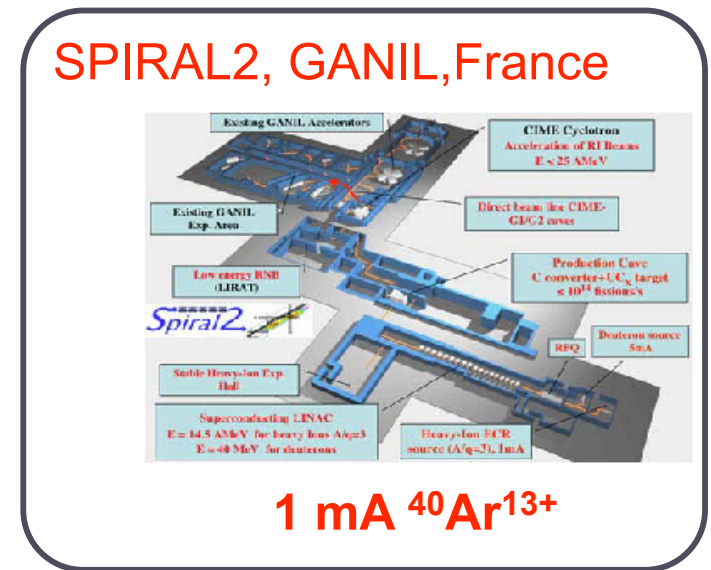
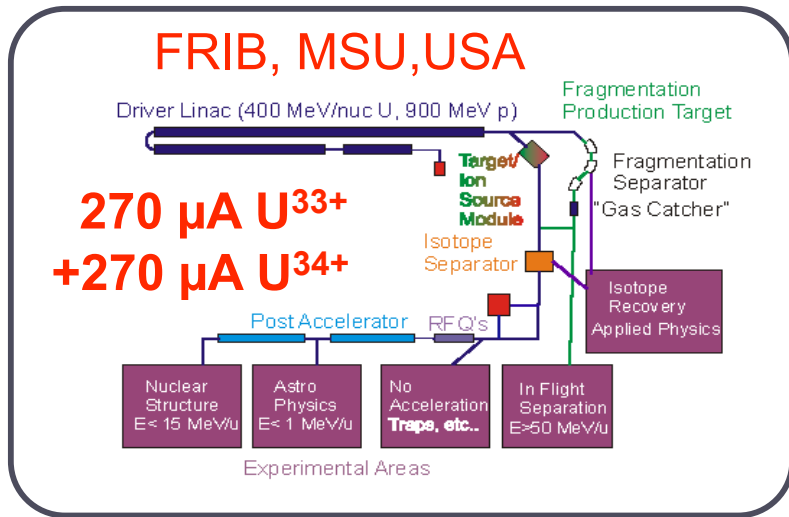

LBNL preliminary 56 GHz magnetic design study

- Magnet design study (Nb₃Tn) presented at ICIS'11, Italy.

Concept for a Fourth Generation ECR Ion Source

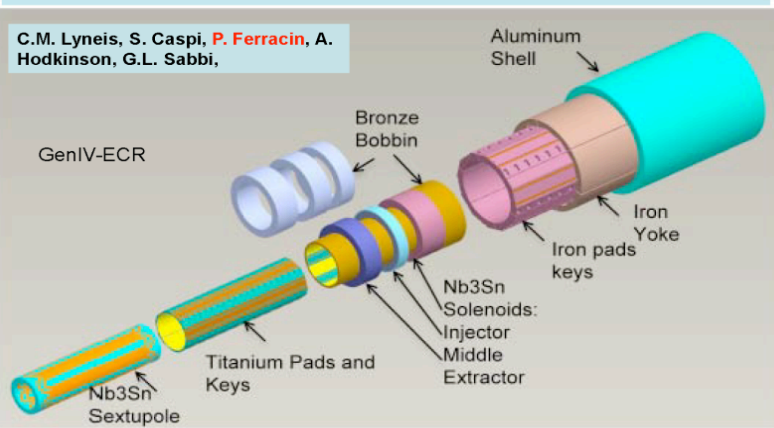

Lawrence Berkeley National Lab



3D analysis with real structure

- All the components of the impregnated coil bonded
 - Both sextupole and solenoids
- Output
 - Peak stress --OK
 - Bonding tension between turns and pole
 - <20 Mpa--OK

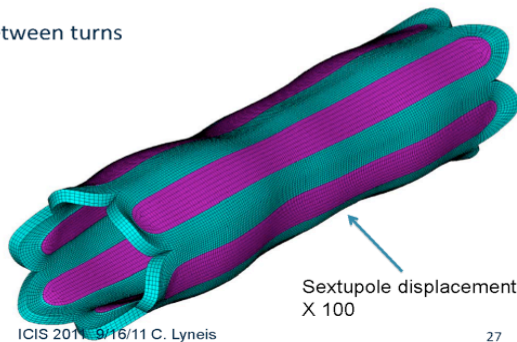

ICIS 2011 9/16/11 C. Lyneis

27



GenIV-ECR Cryostat Design

- Two 5 W GM-JT cryocoolers at 4.2 K
- One shield cryocooler 6 W at 20 K and 120 W at 77 K
- High Tc leads
- Static heat load 1.5 W
- Magnets on + 0.15 W
- Warm bore 170 mm ID
- Designed for HV platform
- No LN cooling

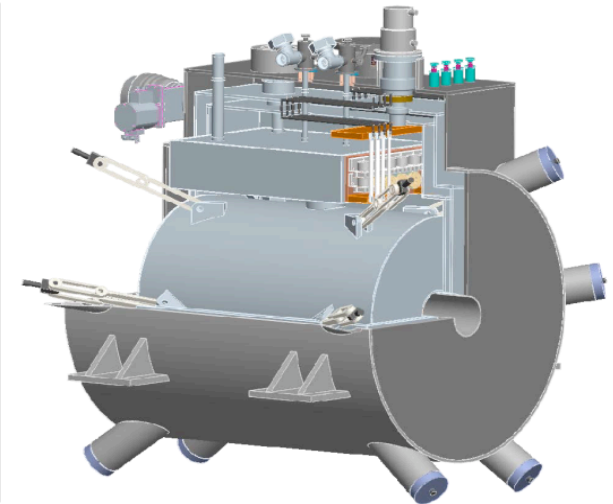

ICIS 2011 9/16/11 C. Lyneis

28

- Complicated engineering with Nb₃Tn
- Feasibility is demonstrated

IMP Lanzhou 50 GHz design

- NbTi is used, relaxing coil stress thanks to « fusion like » coils use (D. Xie at ICIS'11)

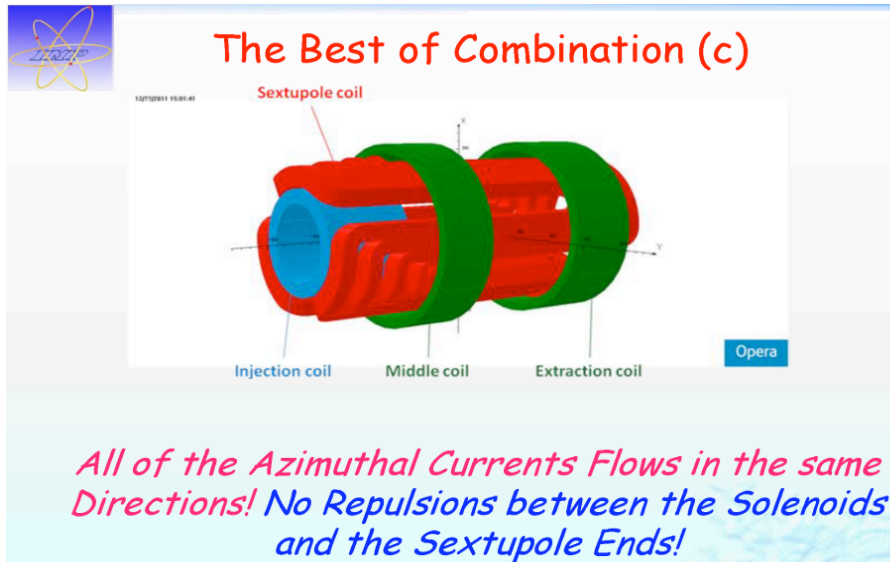

- Use of a sophisticated hexapole directly generating a min-B field
- NbTi Wire used
- forces on coil reduced, but complicated engineering for winding and plasma chamber

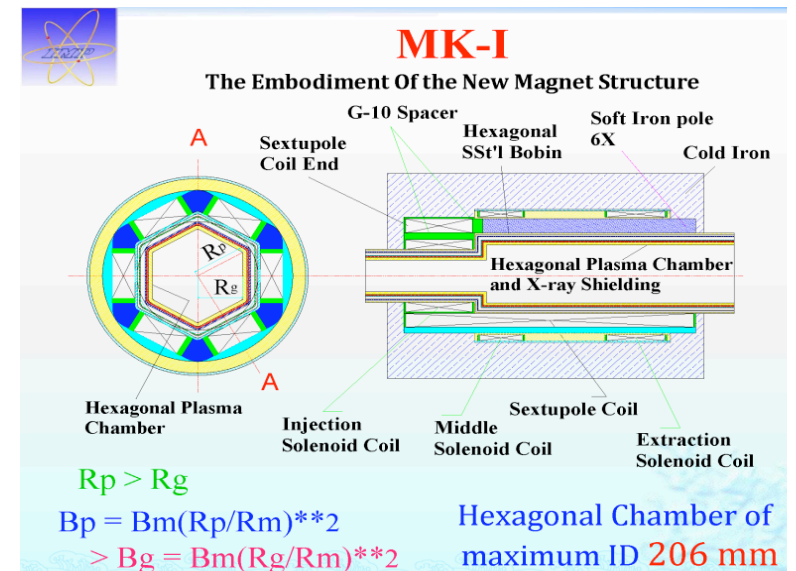
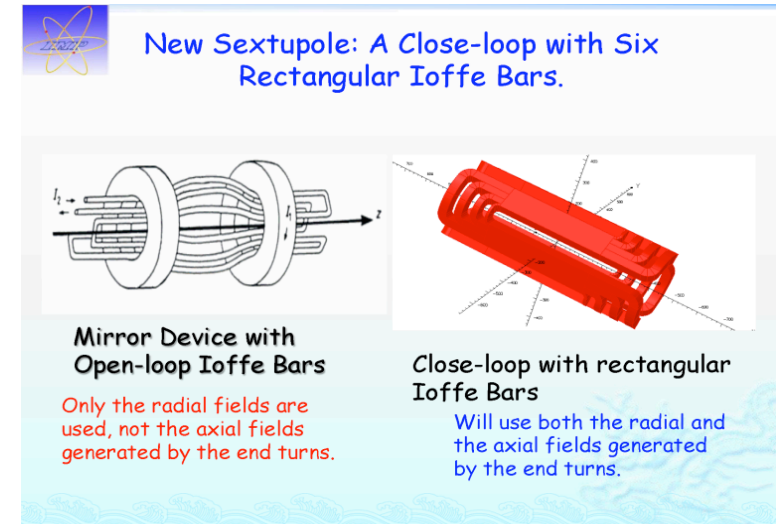

ECR (exotic) Prospects at higher frequency

- High frequency ECR R&D with MegaWatt Magnets (LPSC & GHMLF, Grenoble)
 - Design and build of several copper coils prototypes to study innovative magnetic structures
 - Test at the Grenoble High Magnetic Field Laboratory on a dedicated test bench equipped with a 60 GHz Gyrotron
 - Coil building is simple
 - Allow fast R&D: build, test & improve
 - First prototype is axysymmetric (SEISM)
« CUSP » presented earlier
 - Next prototypes should feature a classical minimum-B structure
 - Ioffe bar style hexapole (Xie) is part of the plan for a long time (CERN EURISOL meeting slides 2006).
 - Once studied and validated, the goal is to switch the source to a superconducting version

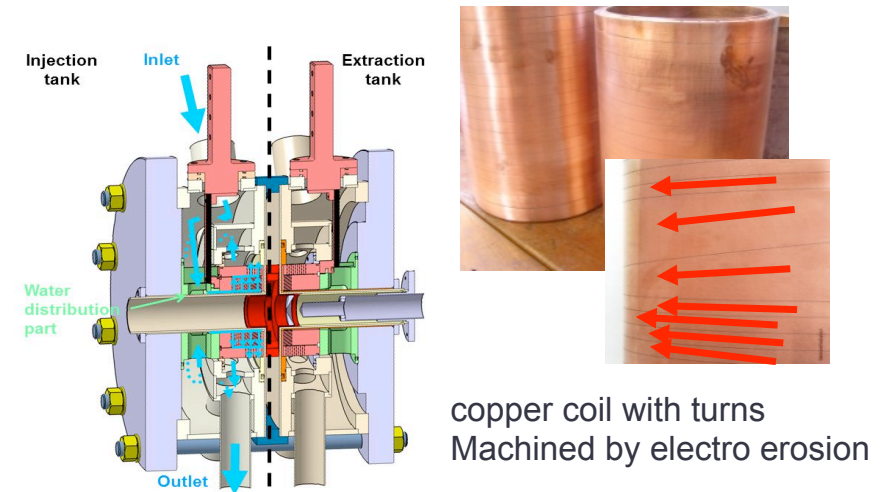

SEISM applied to Beta Beams R&D

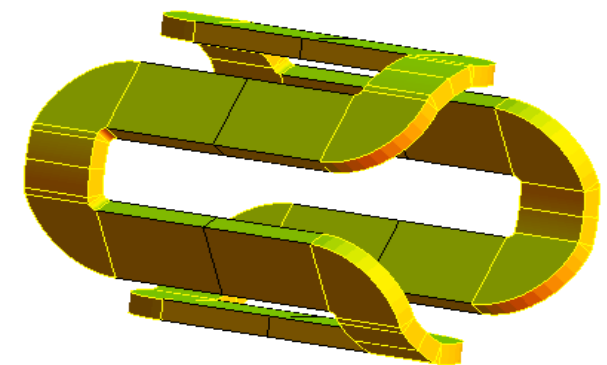

Min-|B| hexapole foreseen, as presented in 2006 at CERN

The challenges of 4th generation ECRIS (50-60 GHz)

- 4th generation ECRIS Magnetic Field at SC coil surface is above NbTi superconducting wire performance
 - This likely Requires the use of another SC wire...Nb₃Sn? A strong R&D is necessary
- 3rd generation ECRIS shows an intense parasitic X-ray flux, generated by the Bremstrahlung of hot electrons impinging the plasma chamber wall, inducing a dramatic extra heat load of the SC cold mass of ~1 W/ kW RF at 24 or 28 GHz... What about a 60 GHz plasma???
- Today total current extracted ($I \sim 5-15$ mA) from 3G ECRIS is highly space charge dominated ... How to manage a 60 GHz beam with $I \times 4$ ($I \sim 20-50$ mA)???
- In high performance ECRIS, an experimental limitation on RF power injected is observed with $P \sim 1$ kW/ chamber liter. How to go further to improve performances?

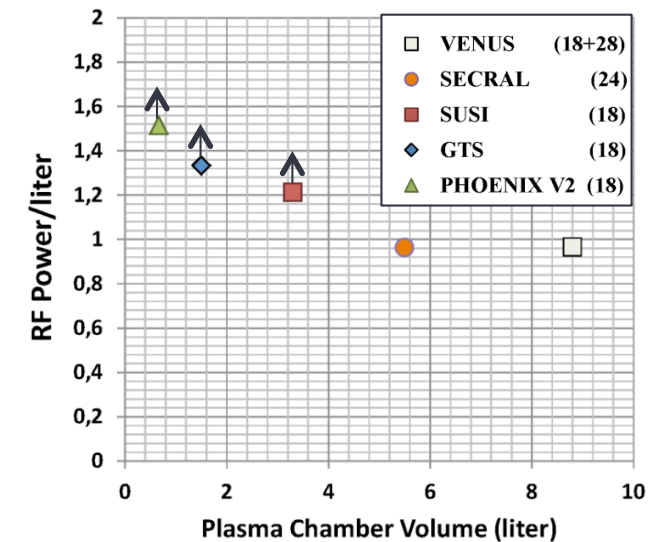
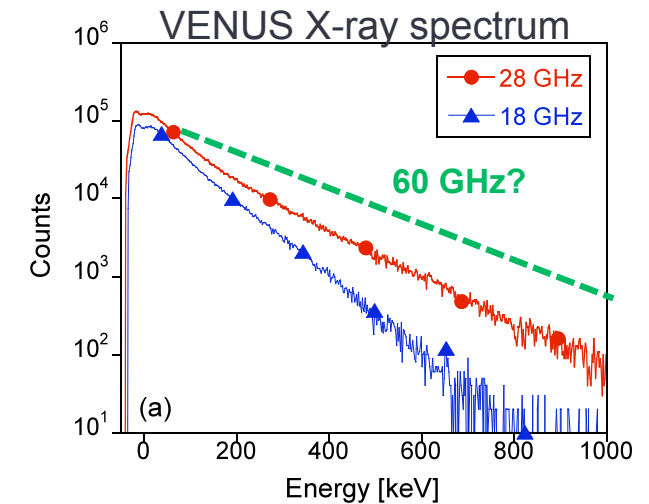

2.45 GHz High Intensity Light Ion Source

• The TAYLOR Source (1991)

- Still a reference in the field
- $f=2.45$ GHz / 2 kW ECR frequency
 - BECR=0.087 T (easy to do)
 - Monomode cavity
- 2 open ECR surface
 - Purely axial field
 - NO MAGNETIC CONFINEMENT
- One single electron pass through ECR
 - $T_e \sim 1-20$ eV
 - $\Lambda_{0 \rightarrow 1+} \sim 7$ cm
- 1+ Ion Source
- Very high intensity: ~ 25 mA of H⁺
 - $\varnothing 4$ mm hole only
 - « High » pressure $P \sim 10^{-5}$ mbar
- Proton Fraction: H⁺ $\sim 90\%$
- H₂⁺ & H₃⁺ $\sim 10\%$
- Low emittance ~ 0.07 π .mm.mrad 1σ RMS norm.
(low B, Triode: see extraction slides later)

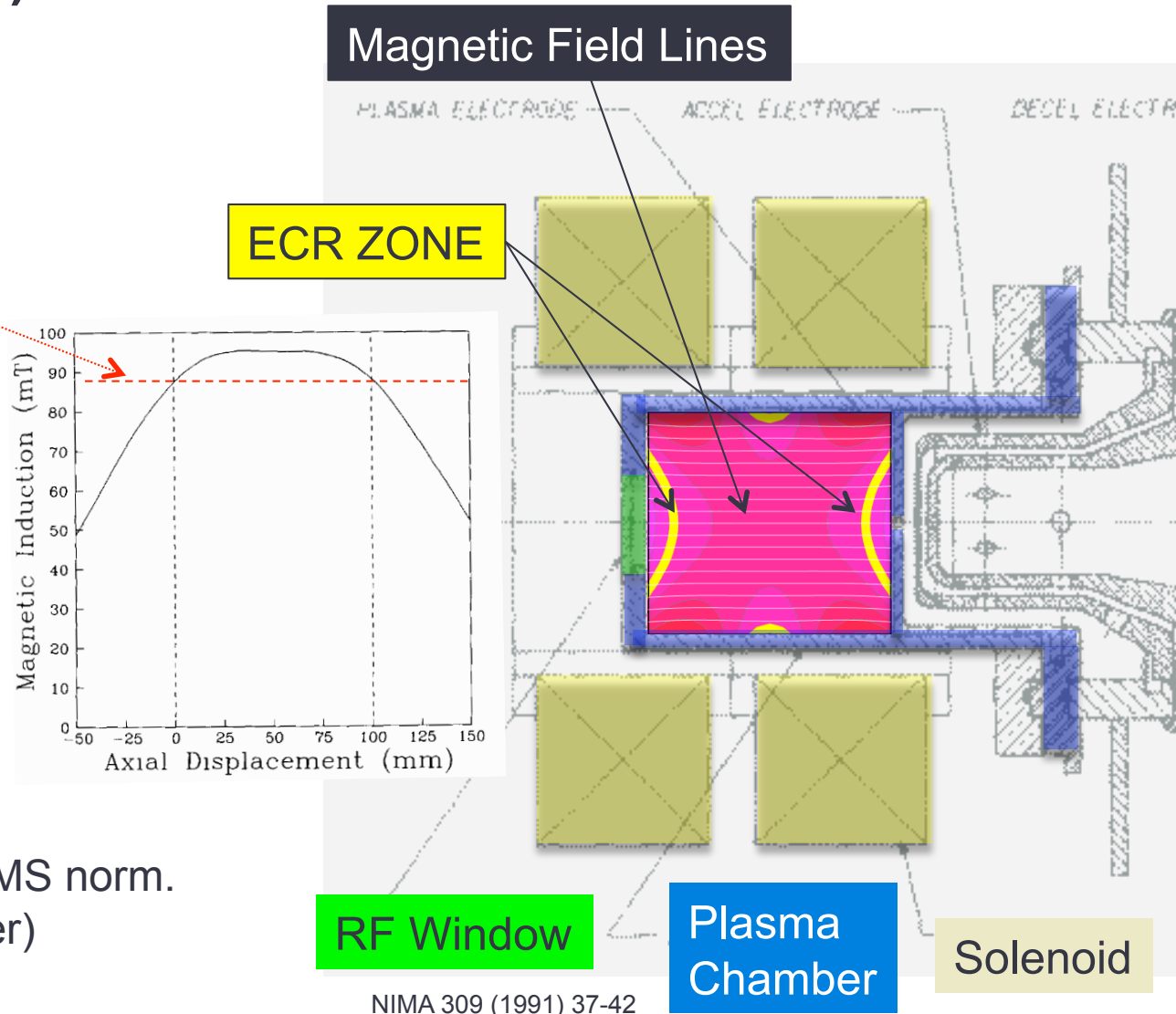

SILHI with permanent magnets (CEA/IRFU)

- A single ECR resonance in the chamber
 - located at the maximum of RF electric field, near to RF input.
 - The second resonance is out of the chamber in the extraction system
- WR340->WR284->double ridge RF transition
- Complicated 5 electrodes extraction to manage very high ionic currents
- $I_{H^+} \sim 100$ mA, 80% Fraction
- High current is obtained by increasing extraction hole \varnothing

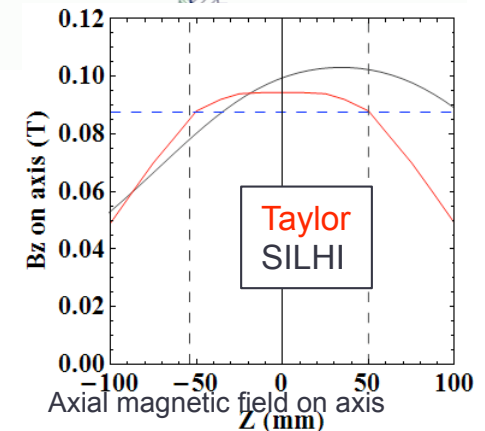
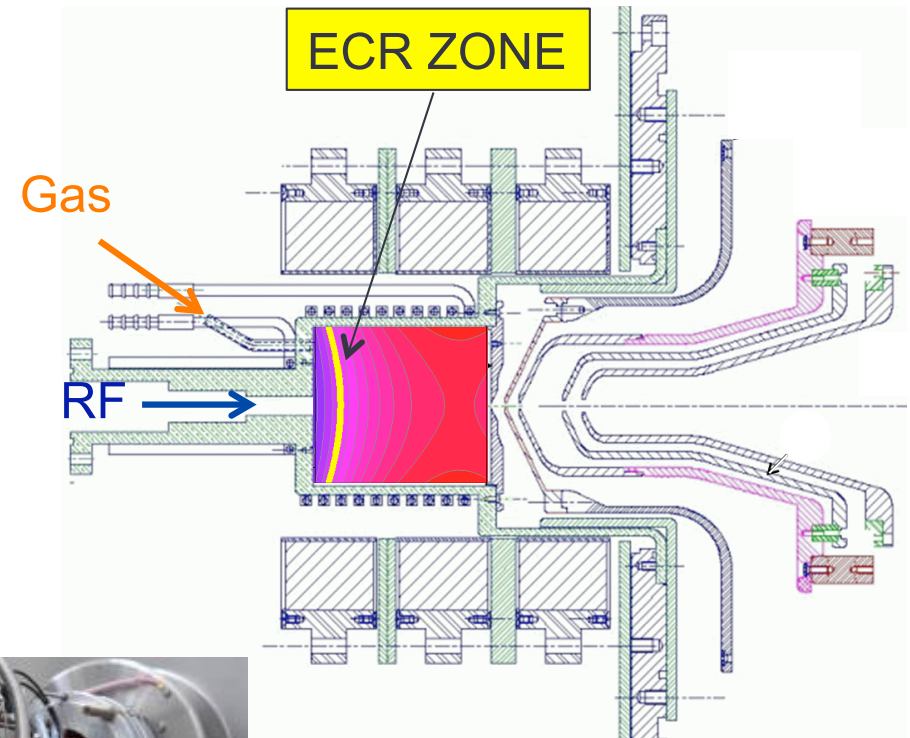

Very Compact 2.45 GHz (Peking University)

- A half length cavity with respect to Taylor
 - $L = 50 \text{ mm}$
- A quarter wave diameter chamber
 - $\varnothing \sim 40 \text{ mm}$
- Permanent magnets
- 50 mA H^+ with a triode extraction
- Direct Waveguide coupling (no transition)
- By the way: **RF Tuners** are mandatory in 2.45 GHz ECRIS to optimize the power coupled to the ECR plasma!

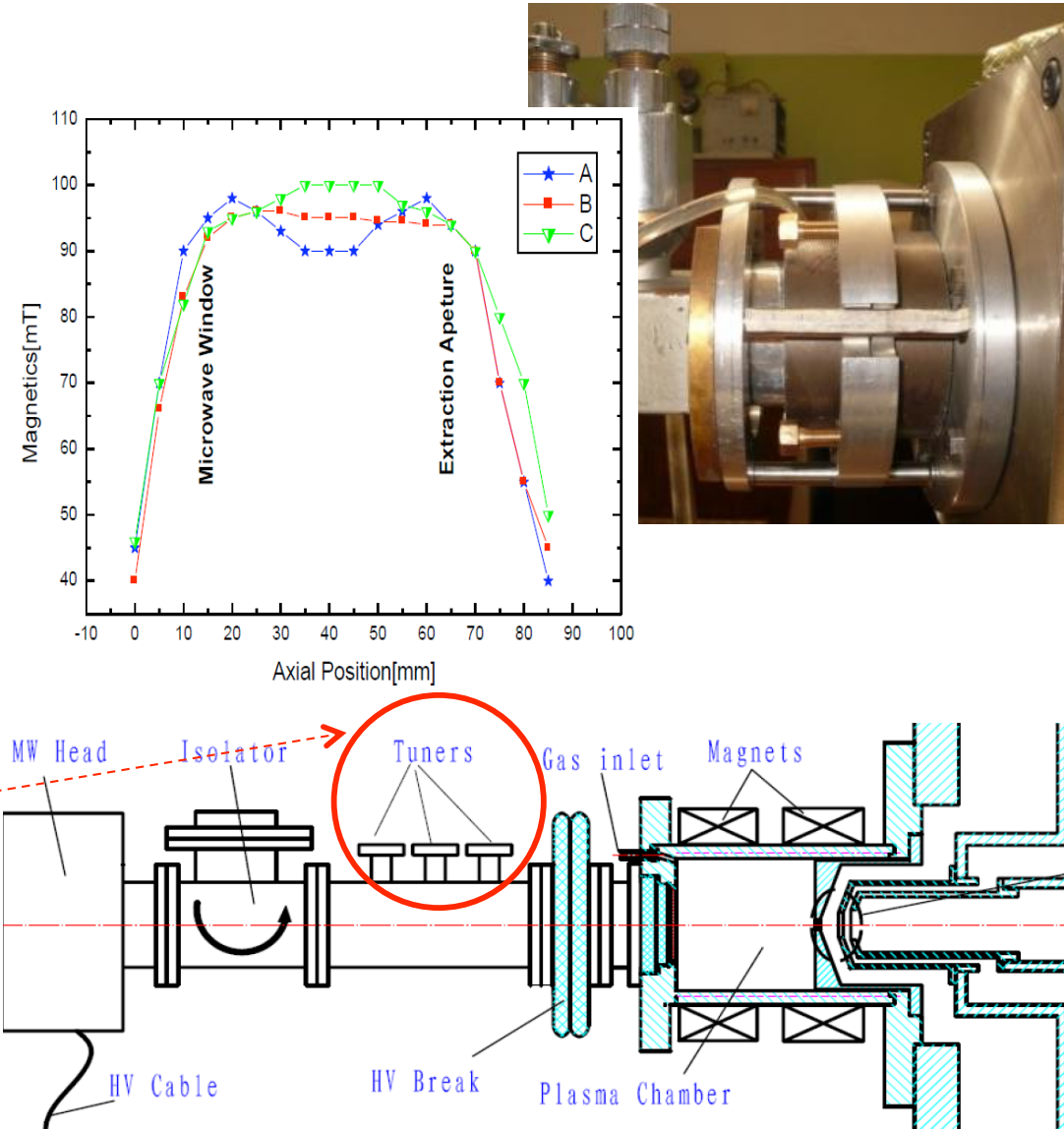

Gas Mixing

- Discovered at KVI (Holland)
- Add He or O₂ gas helps improving high charge state production in an ECR Ion Source
 - Usually He is used for mixing with atomic masses $A < 16$ (O)
 - Usually O is used to mixing with heavy masses $A > 16$
- The extra O or He injected is used as the main buffer gas that sustains the plasma
- The other compound to be highly ionized is injected in low quantity with respect to the buffer gas
- the charge state distribution of the atom of interest shifts to very high charge state (eg fully stripped Ar¹⁸⁺ beam)

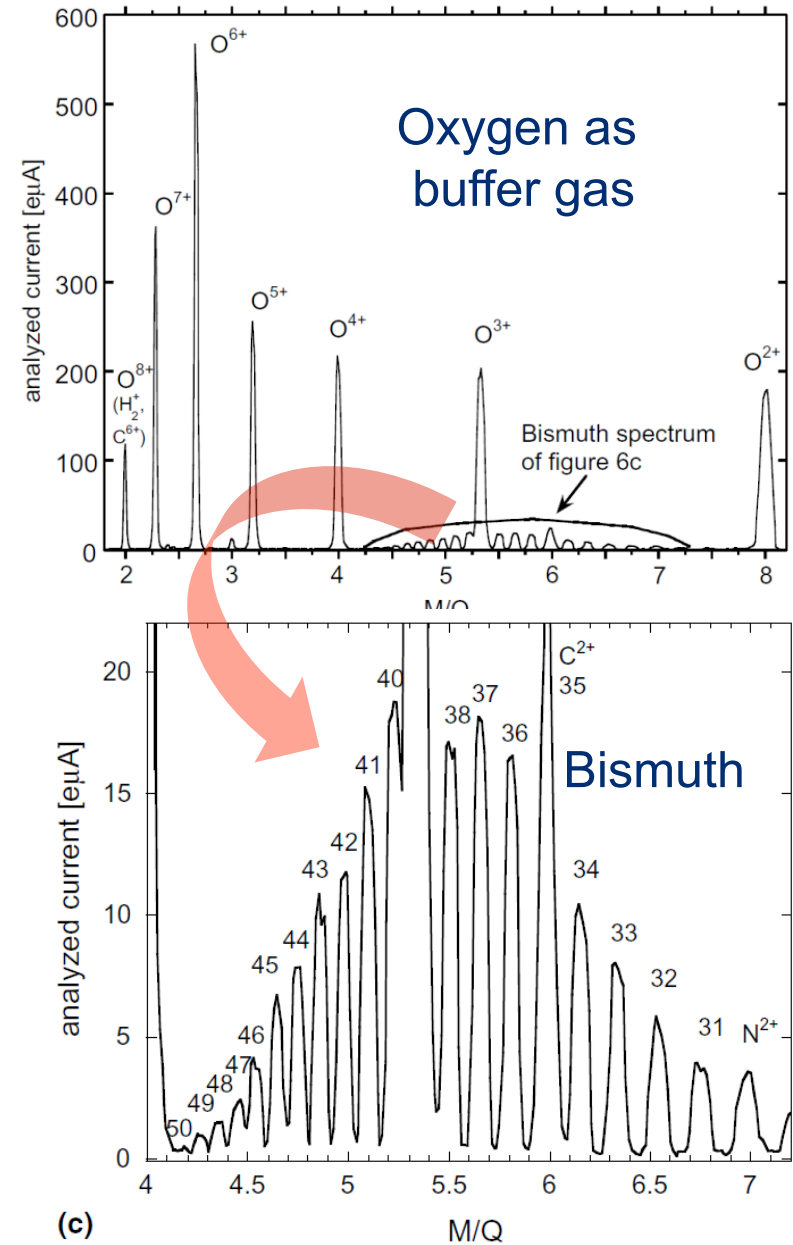

Very high charge states obtained in VENUS with the gas mixing technique

Condensable Ion Beam production in ECR Ion Sources

- The high plasma density of ECR ion Sources features a short mean free path for 1st ionization of atoms:
 $\lambda_{0 \rightarrow 1+} \sim 1 - 10 \text{ cm}$
- On flight ionization of condensable or refractory atom can be performed by several techniques in ECRIS
 - **Oven technique:** An miniature oven is inserted in front of the ECR plasma and heated up to the temperature at which a condensable atom evaporates under vacuum
 - **Sputtering technique:** when the evaporation temperature is unreachable, a sample of condensable is introduced inside the plasma which sputters the material. The sample can be biased to negative voltage to increase sputtering yield.
 - **MIVOC technique** (Metal Ions from Volatile Compounds): condensable atoms are chemically inserted in an organic molecule that is gaseous under vacuum. The gas diffuses to the plasma.
 - **Wall heating:** It is complementary of oven or sputtering technique. A refractory cylindrical metallic liner (Mo, Ta, W) is placed around the plasma chamber with a weak thermal interaction with the water cooled wall. The liner temperature increases due to RF and plasma heating. The sticking time of condensable is reduced, which allows wall recycling and improve the global ionization efficiency.

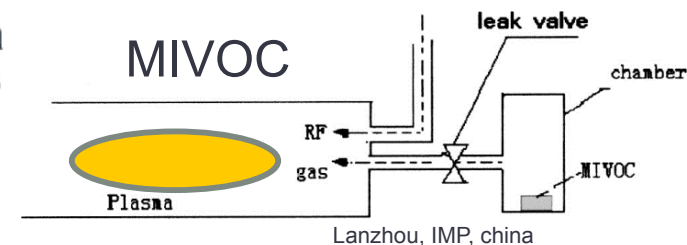
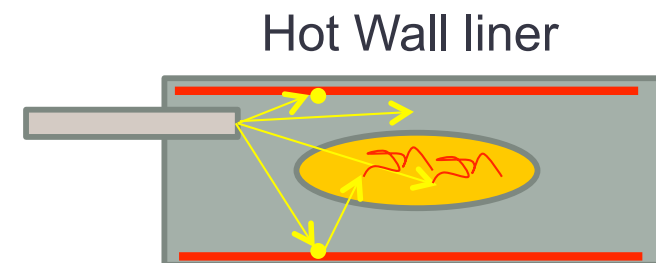
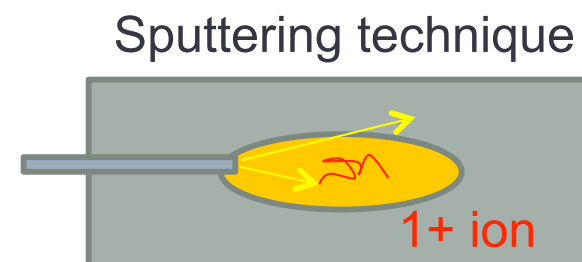
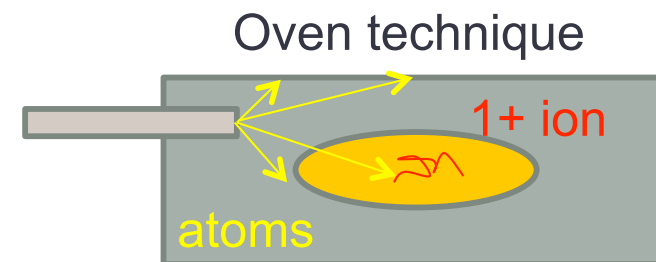

Metallic ovens for ECRIS

• Resistive Filament Oven

- Helicoidal W filament inserted between an inner and outer insulator (alumina)
- Can be very compact ($\varnothing \sim 10\text{-}20\text{ mm}$)
- $T \sim 1400\text{-}2000^\circ\text{C}$ max
 - Depending on design
 - The Alumina crucible melts at 2050°C
- Possibly radiation reflector foil on the outside to improve heating

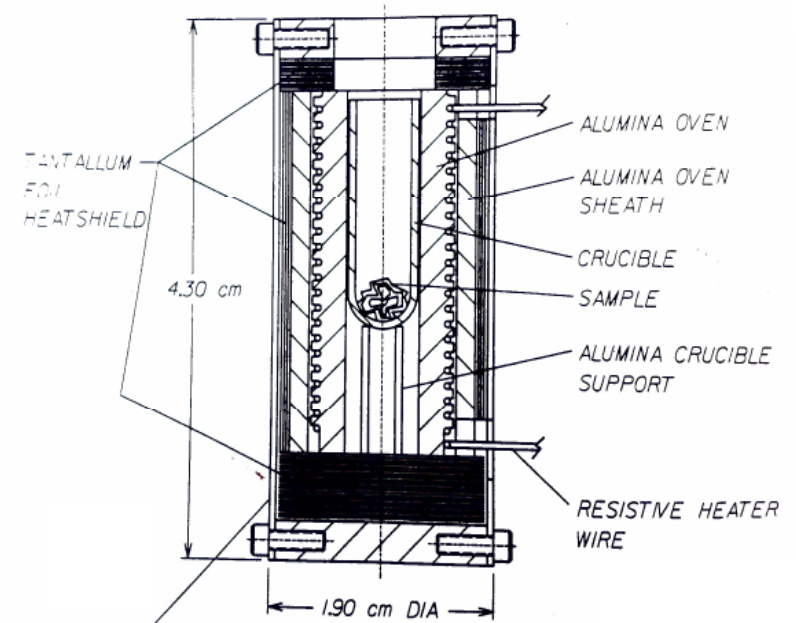

MSU Resistive Filament Oven

• Resistive Foil Oven

- The filament is replaced by a Ta Foil
- The alumina crucible is replaced by a Mo one
- $T_{\text{MAX}} \sim 2000\text{-}2600^\circ\text{C}$ (Mo melting)
- $\varnothing \sim 20\text{ mm}$
- Requires a careful thermal design study

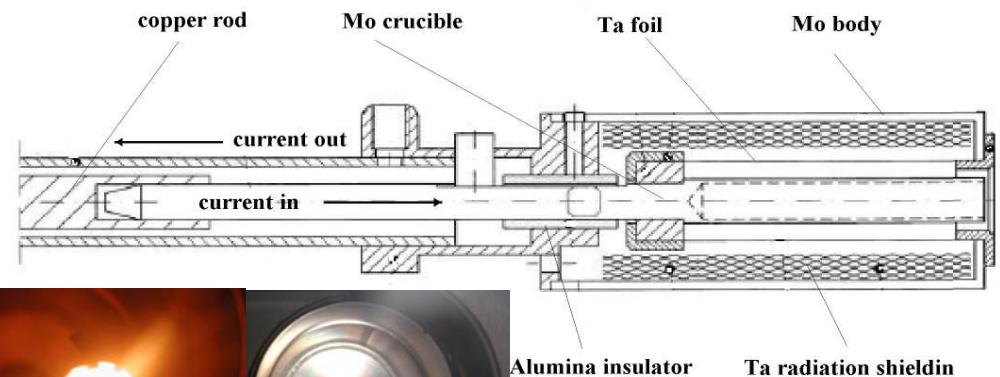

JYFL Resistive Foil Oven



Metallic ovens for ECRIS

• Massive resistive oven

- The crucible is directly the heated resistor (Tungsten)
- Large oven (~4 cm), large metal capacity
- Requires large DC current 350 A/3V
- $T_{MAX} \sim 2000-2300^{\circ}\text{C}$
- Large current through leads may generate electromagnetic force in the magnetic field of the ECRIS:
 - $F \sim IB$
 - Thermo-mechanical calculation required

• Inductive oven

- The metallic crucible is inductively heated by a water-cooled excitation coil
- $T_{MAX} \sim 2000-2600^{\circ}\text{C}$ (Mo melting)
- The tricky part is the external pulsed current generator to excite the coil ($f \sim 100-200$ kHz $P \sim 1$ kW)
- $\varnothing \sim 25$ mm

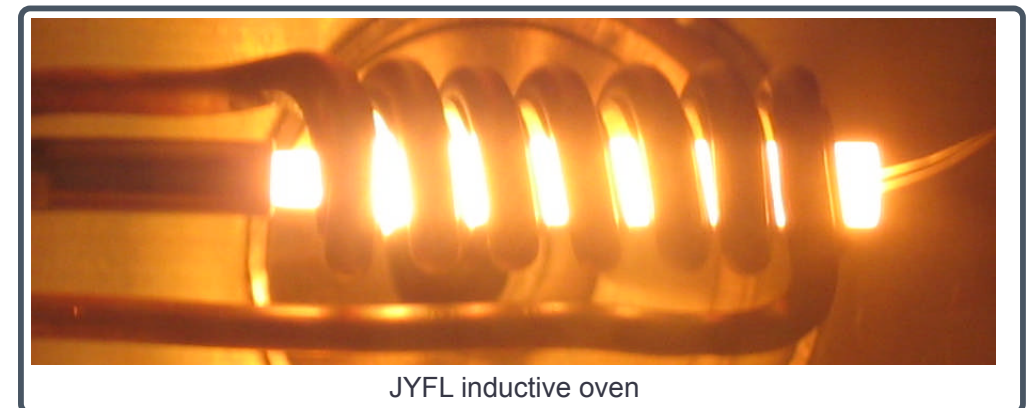
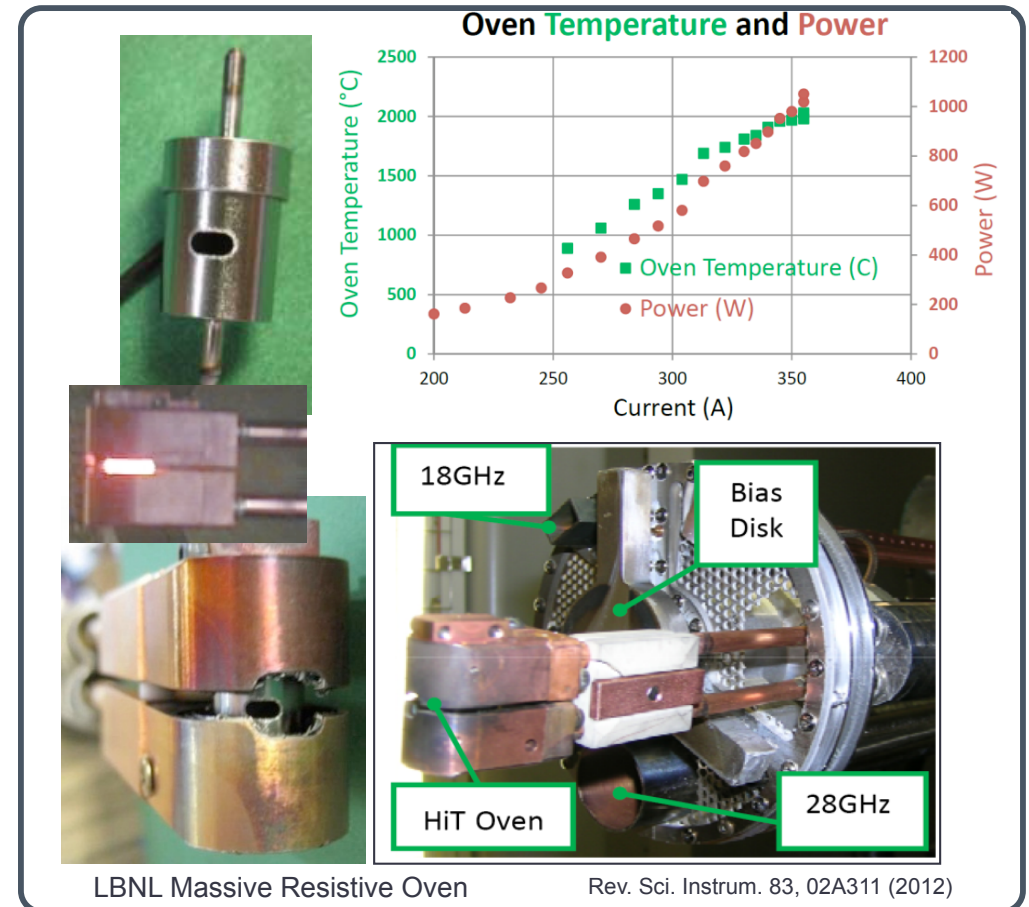

Typical metallic beam intensities

- Metal consumption ~0.1-10 mg/h depending on the tuning and the source
 - Consumption is a concern when expensive elements like ^{48}Ca is requested
- Global ionization efficiency of oven is ~10%
- Hot liner Recycling helps to reach ~ %
- Run duration ~days to ~weeks depending on the crucible volume and the metal consumption

Uranium Sputtering stick
Inserted on the plasma
Axis to make U beam
On SECRA

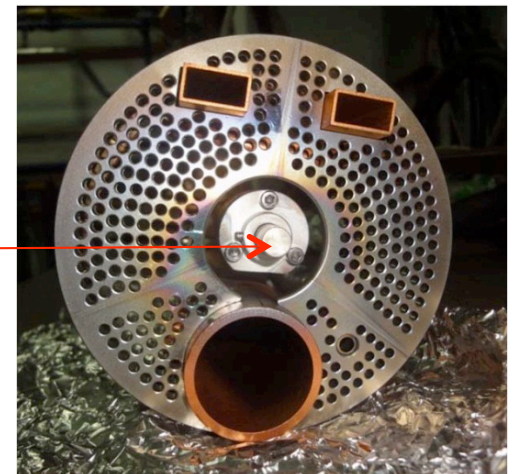

Pulse Mode operation for Synchrotrons: The Afterglow

- When the RF is pulsed, ECRIS can be tuned to produce a high intensity peak with a duration $\delta t \sim 50 - 400 \mu s$, suitable for multi-turn Synchrotron injection
- LHC Lead beams are produced in Afterglow mode (GTS ECR) **RF**

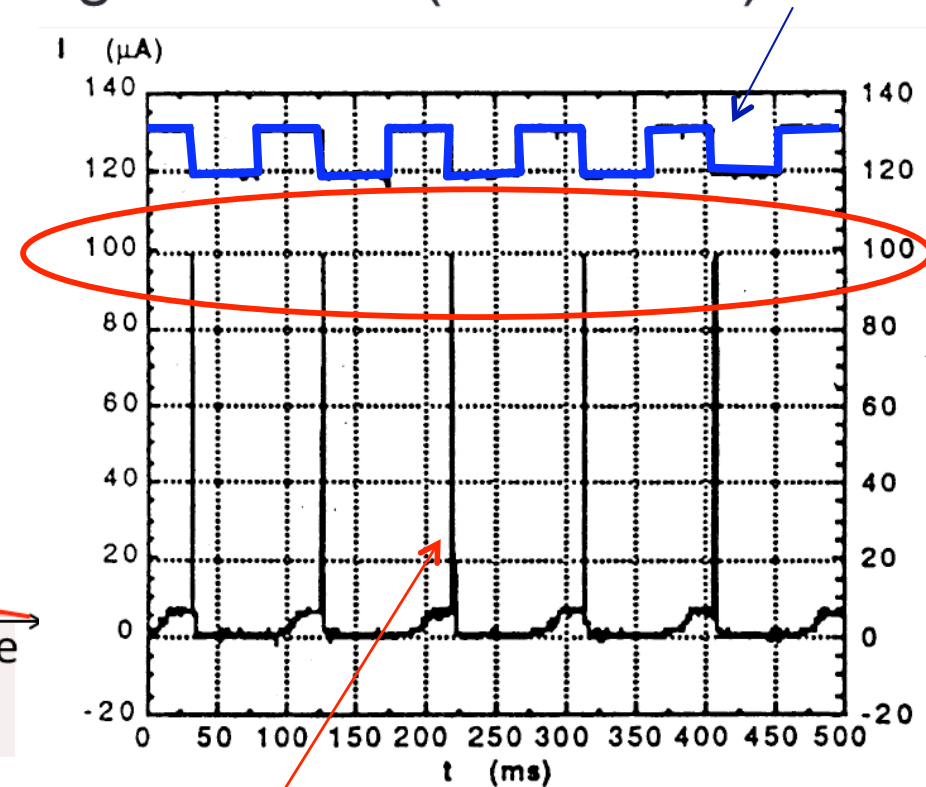
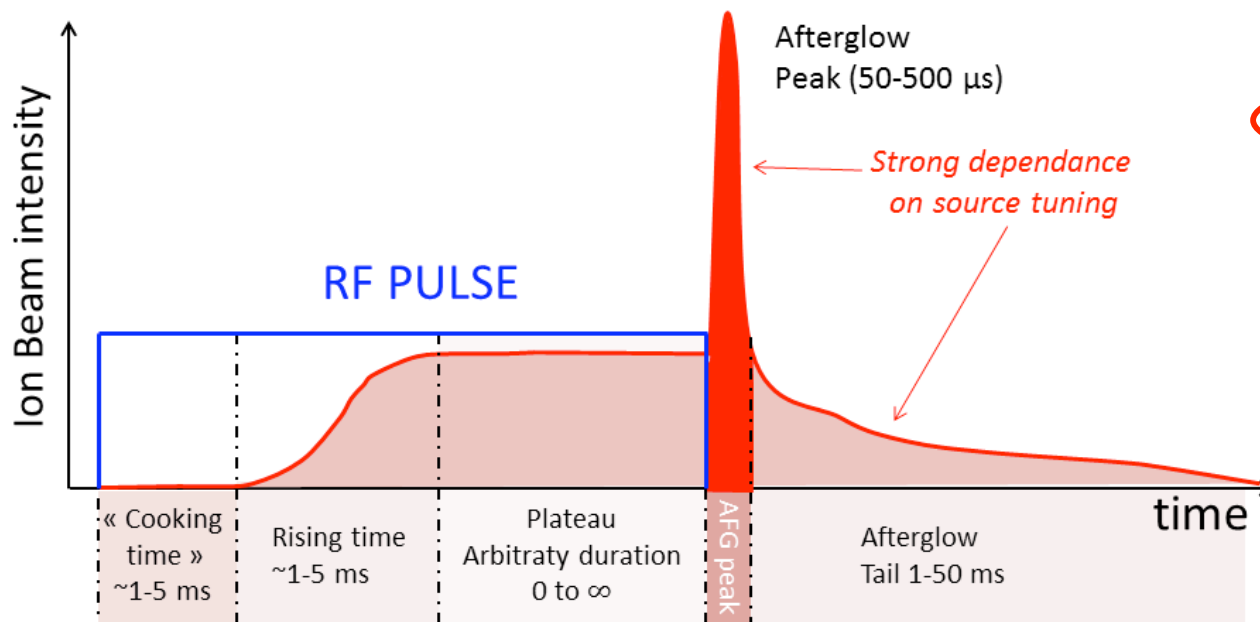

Pb²⁸⁺ pulses (ECR4 GANIL)

The Afterglow mechanism

- The ECR is tuned to provide High plasma confinement
 - $B_{ext} \sim B_{inj} \Rightarrow$ very small loss cone
 - \Leftrightarrow Very low extracted current in CW mode
- The hot confined electrons population, maintained by the RF, build a large potential dip $\Delta\Phi$ around the axis
 - Pastukov, 1974
 - \Rightarrow Accumulation of ions trapped at the center of the source
- At RF stop: the electron heating stops brutally:
 - \Rightarrow Fast destruction of the potential dip $\Delta\Phi \rightarrow 0$
 - \Rightarrow Deconfinement of multicharged ions
 - \Rightarrow High intensity peak of multicharged ions

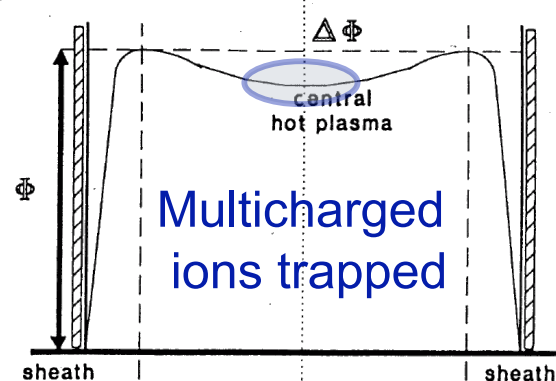
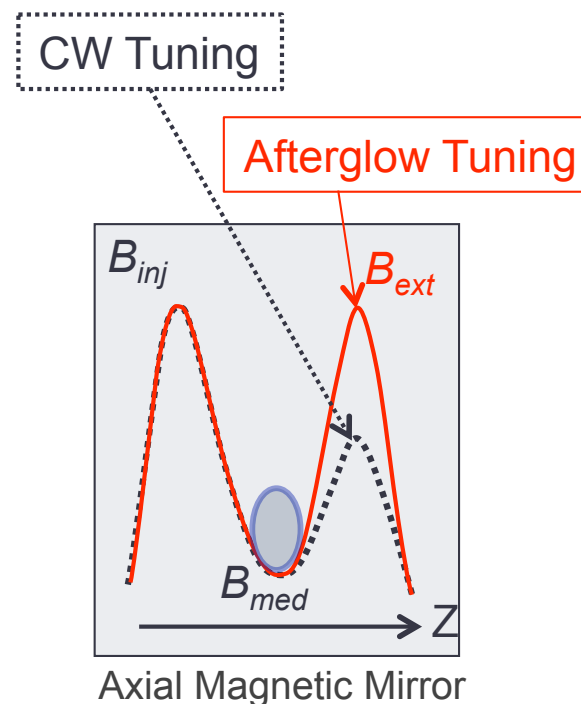

Lead Afterglow Spectrum

- 650 μA Pb²⁵⁺ - 28 GHz- PHOENIX V1 SOURCE (LPSC) - 10 ms/10 Hz

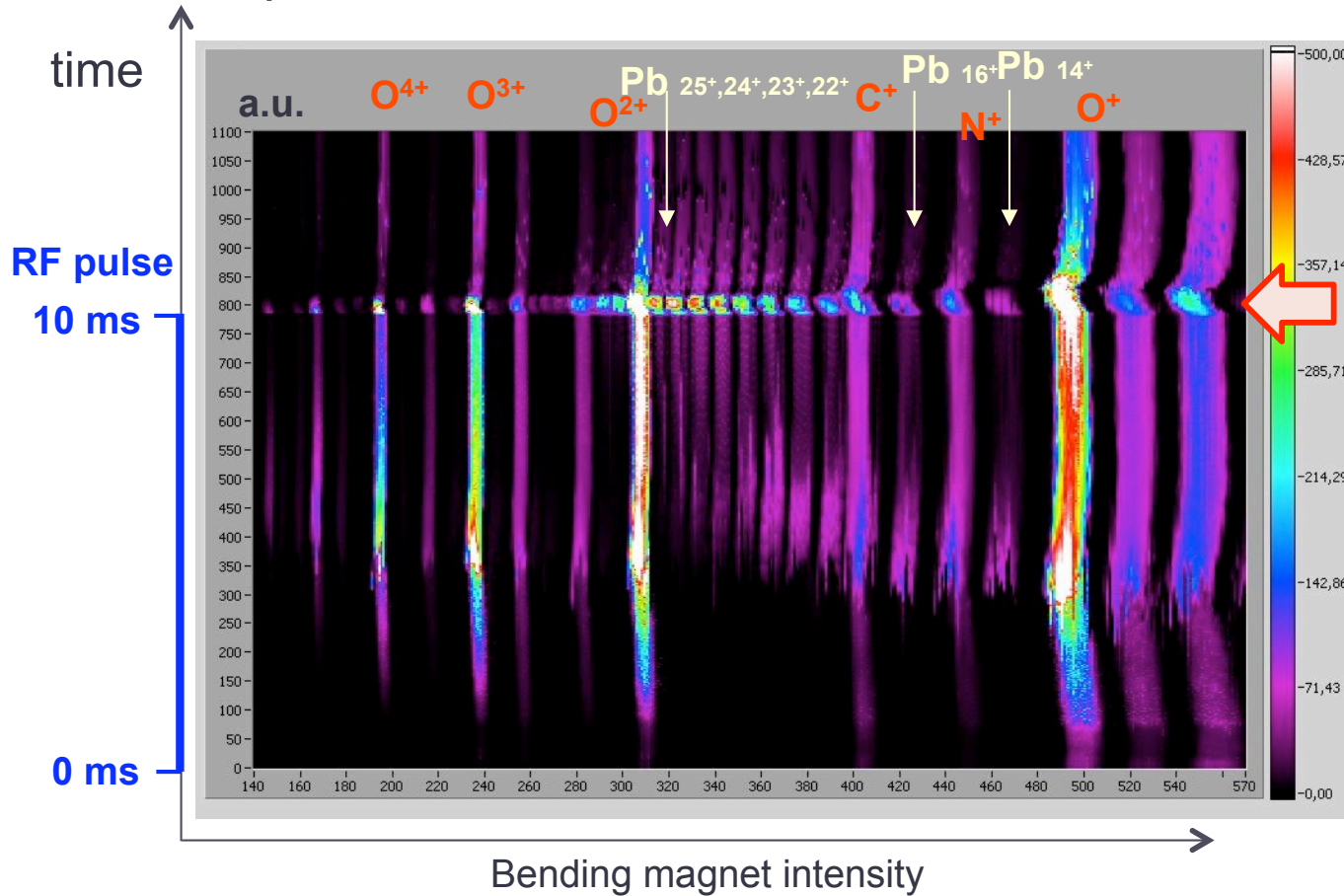

AFTERGLOW

Very stable tuning at 500 μA

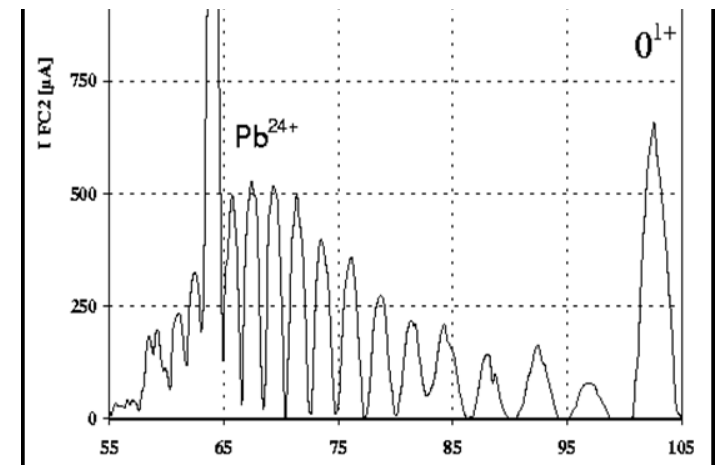

The Preglow mode (under R&D)

- Discovered by chance at LPSC during afterglow studies
 - Intense transient peak occurring at plasma breakdown
 - Studied at 18 and 28 GHz ECR frequency
- The Preglow is reproduced with a 0D model developed at IAP (Russia)
 - Main assumption: build up of a superadiabatic high energy electron distribution function (EEDF) at early plasma breakdown, when n_e is low
 - The confined electrons absorb all the RF power and reach high energy
 - When n_e increases, plasma leaks and collisions with ions become dominant and the superadiabatic EEDF damps brutally to a lower energy one (maxwellian).
 - during the EEDF damping, high Transfer of energy from electrons to ions occur (through electron impact ionisation)
 - ⇒ transient Preglow peak

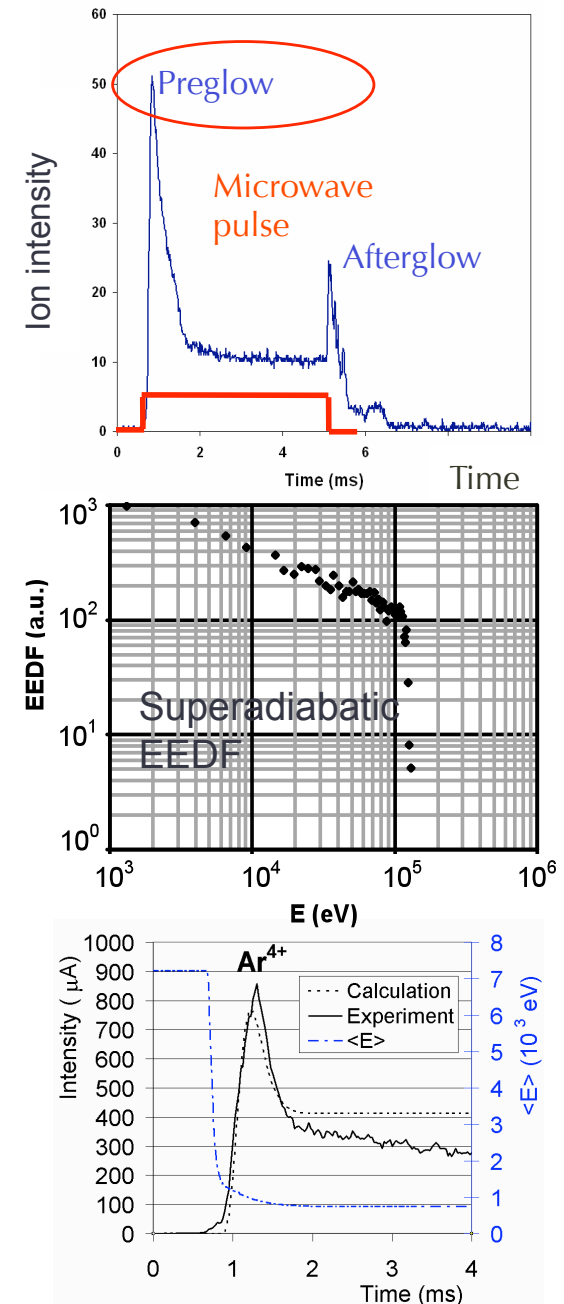

1+N+ Method in ECRIS

- Dedicated to Radioactive Ion Beam post-acceleration

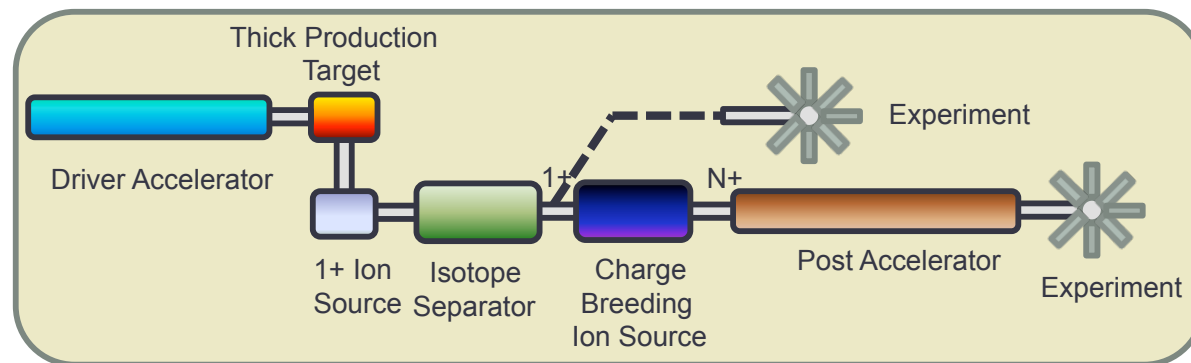

- Invented by R. Geller at Grenoble
- Method under development in many laboratories GANIL(SPIRAL1→2), ANL(CARIBU), TRIUMF (ISAC2), KEK(TRIAC), LNL(SPES)...

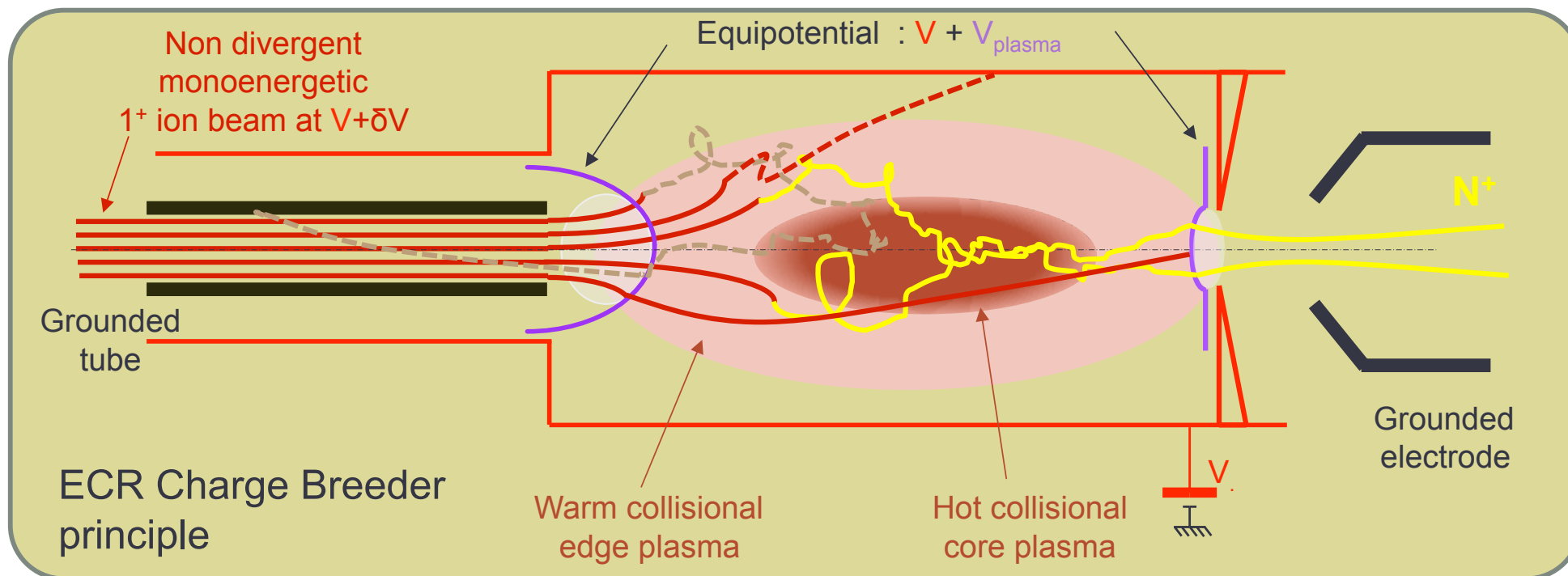

ECRIS Charge Breeding – efficiency - ΔV

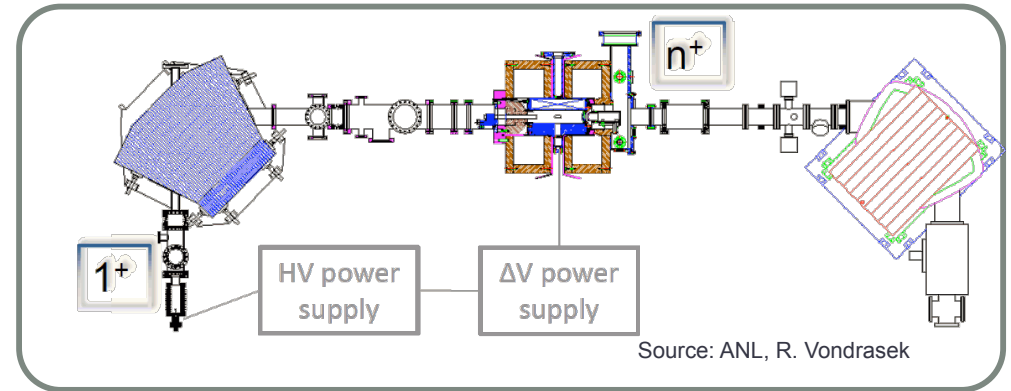
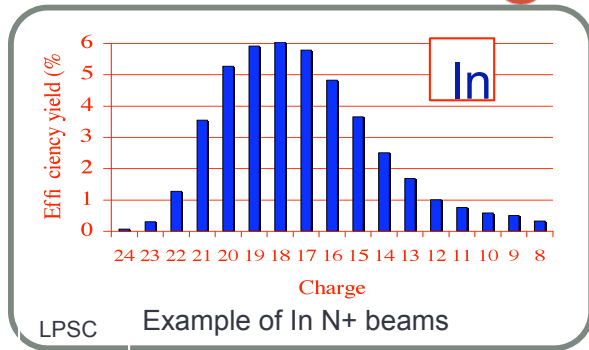

- Efficiency for n+ ion: $\eta_n = \frac{I^{n+}}{n \cdot I^{1+}}$
- The 1+ ions should be accurately decelerated to match the plasma capture condition (ΔV curve=function of both source plasma potential)
- Today, the main limitation comes from the beam contamination with impurities (from plasma chamber walls)
- Small intensity RIBS may be hidden by a nearby Q/A contaminant

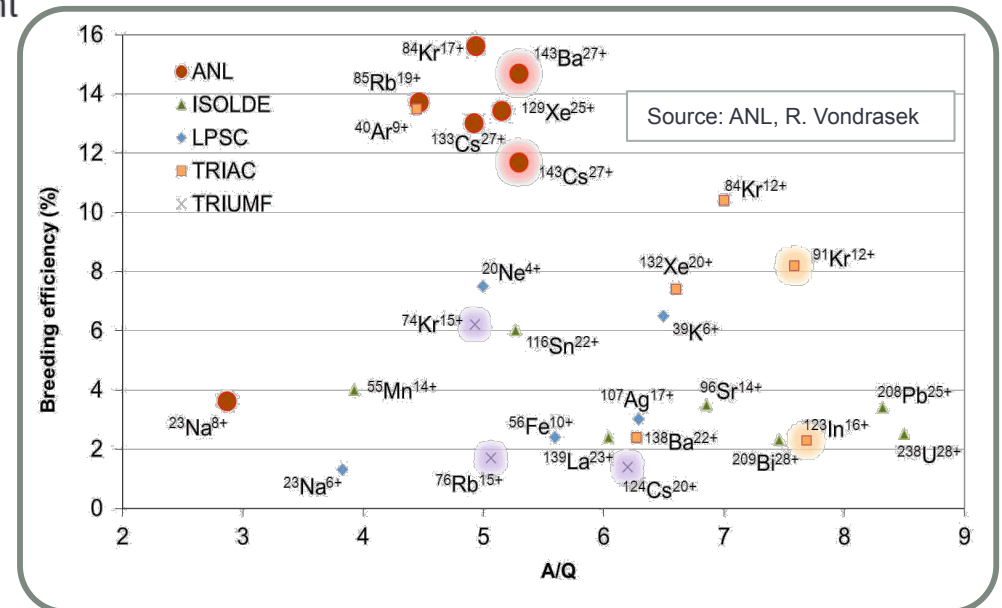
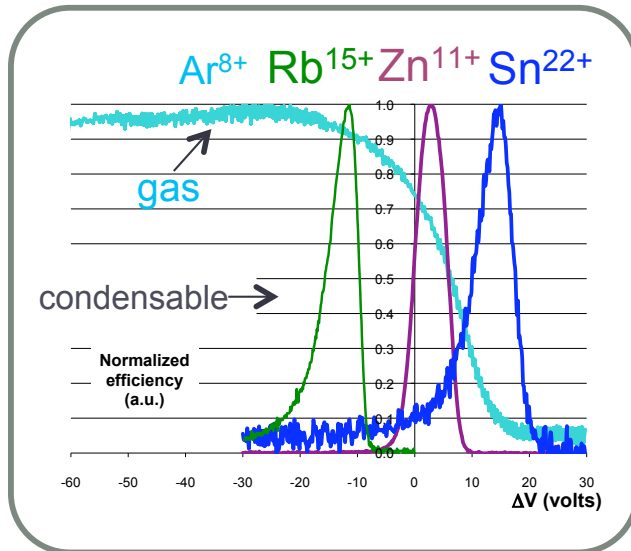

ECR Charge breeding as a plasma probe

- Evidence of step by step ionization process in the ECR plasma

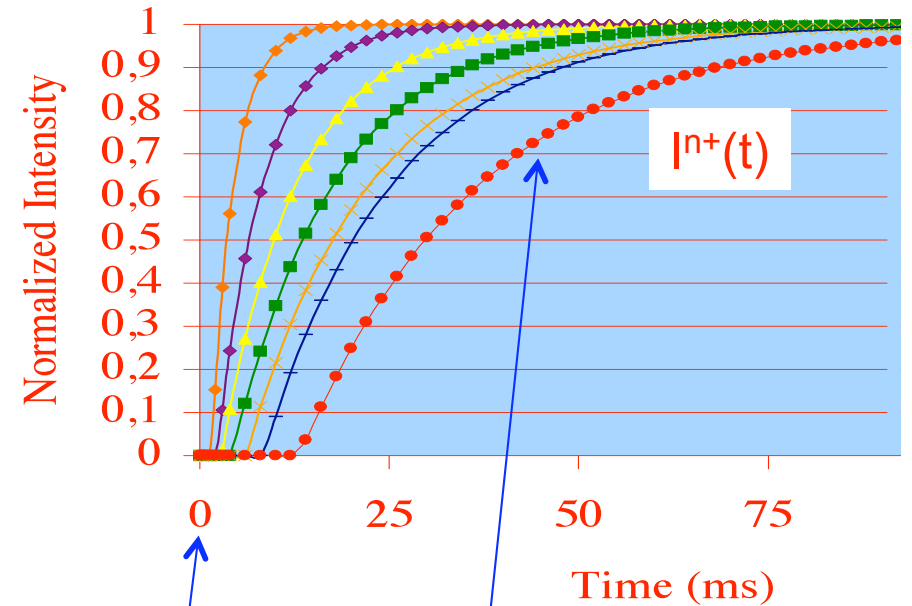
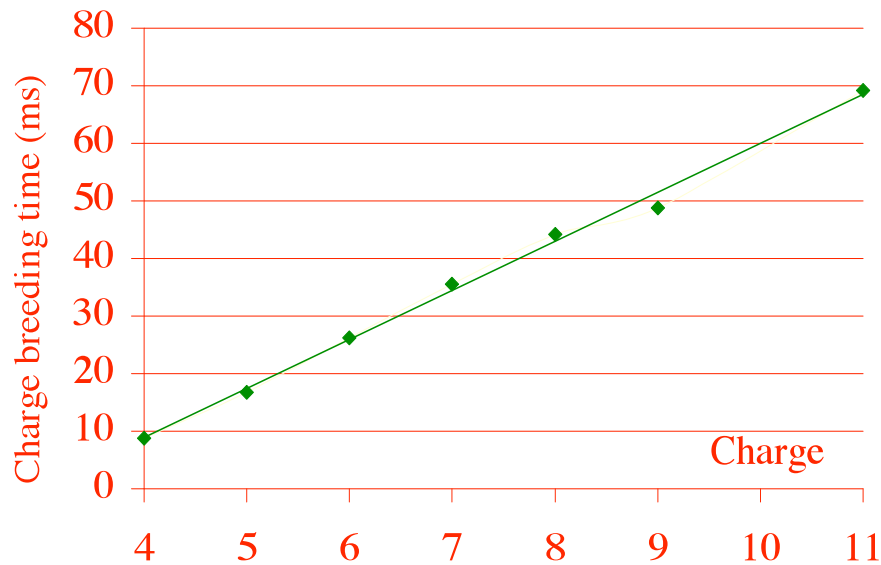
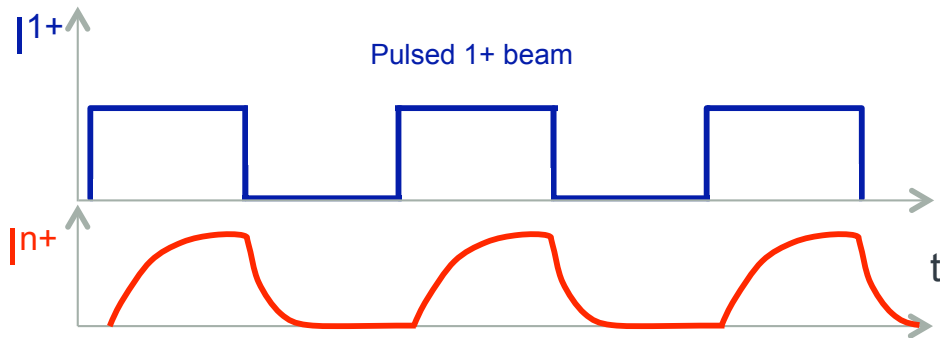

1+ beam injection

Charge Breeding time =
time for $1+ \rightarrow N+$ ionization +
Time for plasma escape
(confinement time)

Experiments done with the PHOENIX Charge Breeder (LPSC)

Beam Extraction from ECR Ion Sources

- The ion beam is extracted by setting the plasma chamber to high voltage
 $V_{HV} \sim 15-60$ kV
- A plasma electrode is closing the cavity on the extraction side, it is equipped with a circular hole with diameter $\varnothing \sim 5-13$ mm
- A puller electrode, set to ground potential, is placed in front of the plasma electrode
- The electric field in the gap d enables to accelerate the low energy ions from the plasma while hot electrons are repelled back to the source

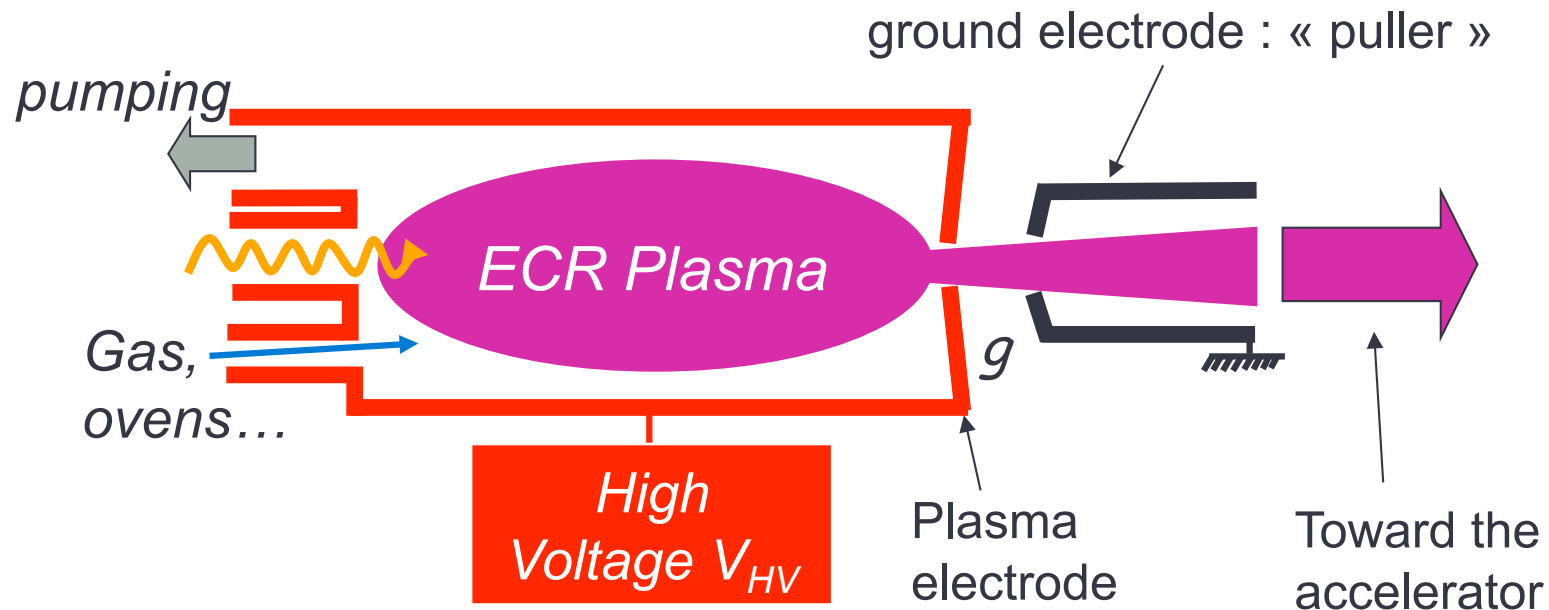

Ion Extraction from the plasma

- The plasma potential is $V_p > 0$ (usually $\sim 5-50$ eV)
- The plasma meniscus is the natural curvature of the plasma in front of the circular electrode hole
- The plasma meniscus shape is not predictable. A concave meniscus is optimum for ion extraction.
- The ions are extracted from the plasma sheath (non neutral area, see appendix).
- The ions incident velocity in the early sheath can be modeled by the Bohm criterion:

- $v_i = \sqrt{kT_e/m_i}$

- Ions extracted have escaped the magnetic mirror, so their initial velocity angle θ with respect to \vec{B} are distributed in the loss cone ruled by the Axial Mirror ratio $R = \sqrt{B_{max}/B_{min}}$:

- $v_{\parallel} = v \cos \theta$

- $\sin \theta \leq \frac{1}{\sqrt{R}}$

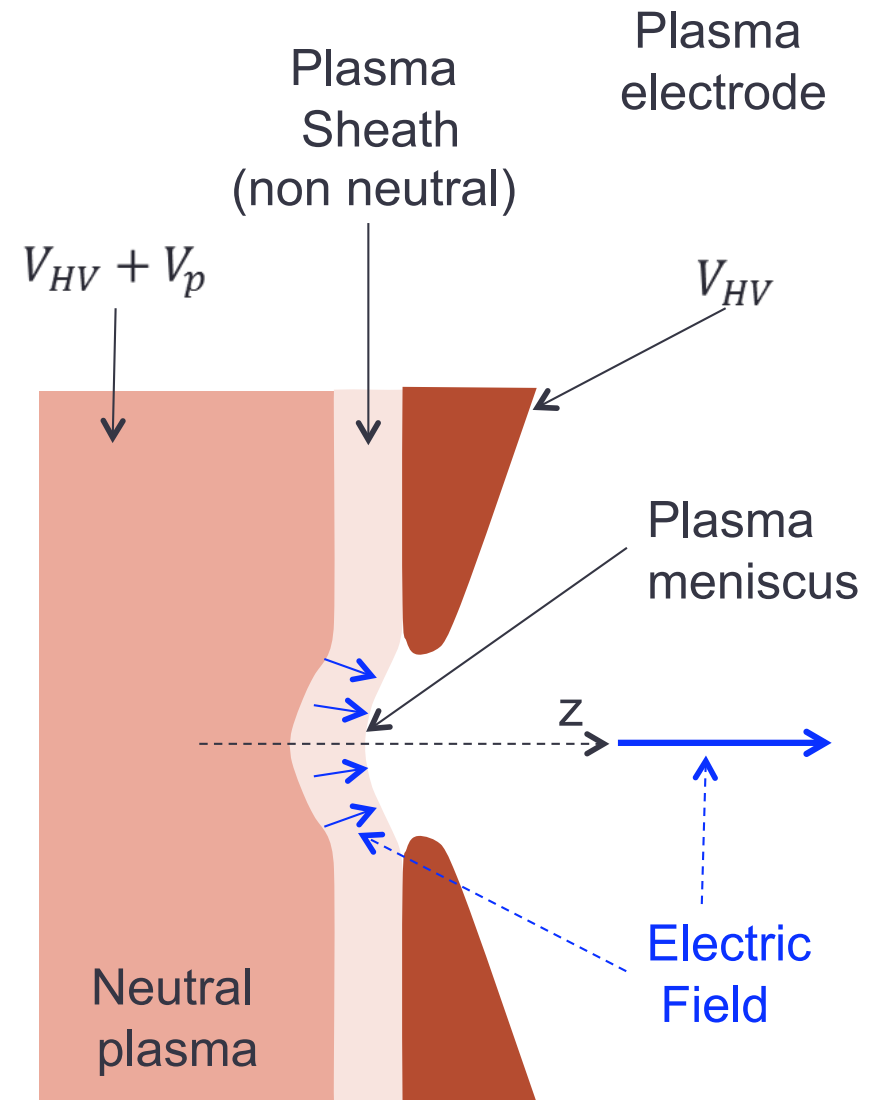

Hot Electrons contribution to the emittance

- The hot electrons of ECRIS play an important role in the early beam formation, when the ions have very low energy
- Hot electrons ($kT_e \sim 1 - 5 \text{ keV}$) penetrate into the extraction gap and neutralize partially the space charge induced by the ions, until a point where they are reflected back to the source
- The electron density in the ECR plasma sheath is usually approximated by the Boltzmann distribution function, assuming a gaussian electron distribution function:

- $$n_e = n_{e0} e^{\frac{e(V(z) - V_{HV} - V_p)}{kT_e}}$$
 - n_{e0} is the electron density in the neutral plasma
 - $V(z)$ is the local potential at position z in the extraction area
 - V_p is the plasma potential, V_{HV} the High Voltage

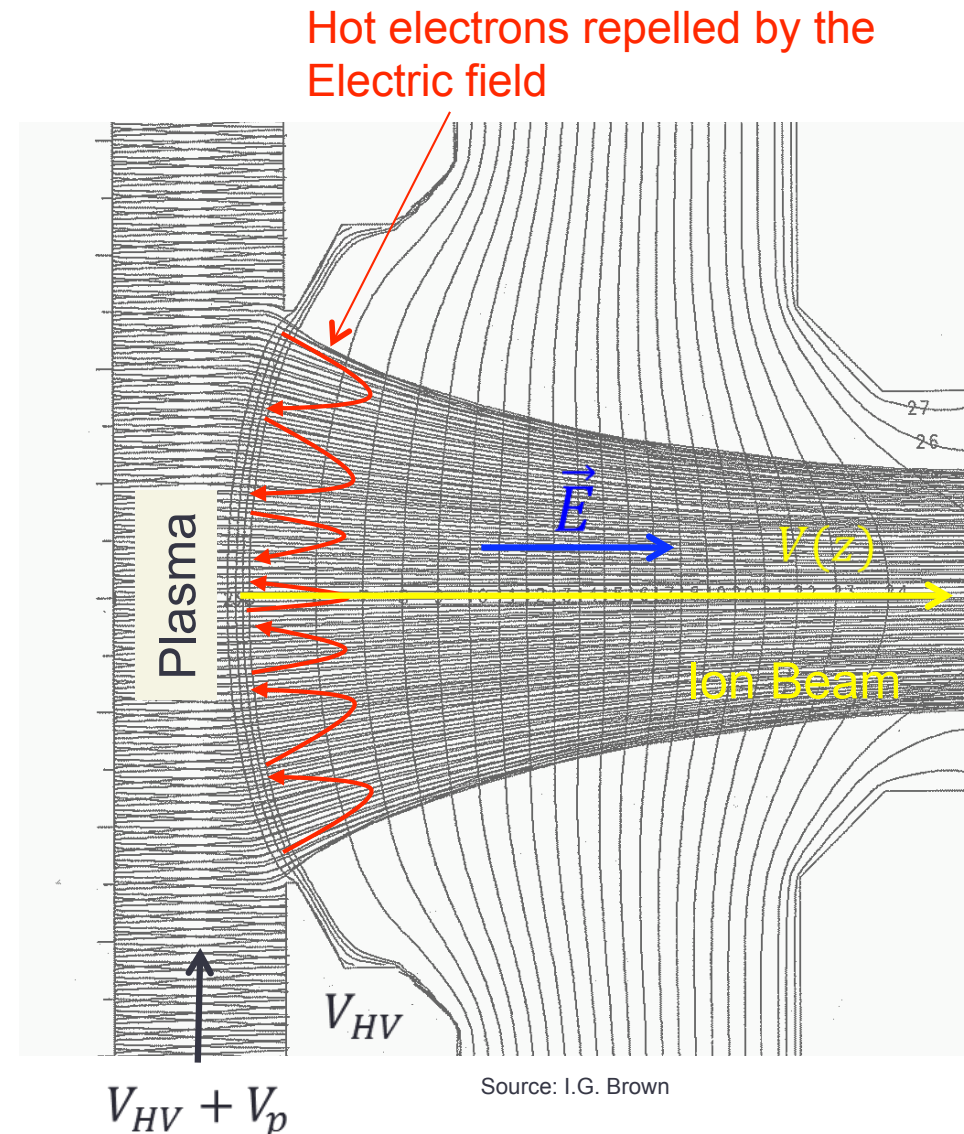

Ion Beam Emittance from an ECRIS

- The beam emittance from an ECRIS has mainly two origins:
 - **Thermal emittance** induced by ion beam temperature (OFTEN NEGLIGIBLE)
 - $\epsilon_T^{xx'-rms-norm} = 0.016r \sqrt{\frac{kT_i}{M/q}}$
 - kT_i ion temperature ($\sim 1/40$ eV)
 - r electrode radius (mm)
 - M/q mass over charge in amu
 - **Magnetic emittance** induced by the beam rotation due to the decreasing magnetic field when the beam exits the source: THIS IS THE DOMINANT TERM
 - $\epsilon_B^{xx'-rms-norm} = 0.032r^2 B \frac{1}{M/q}$
 - B magnetic field intensity at the plasma electrode
 - r electrode radius (mm)
 - M/q mass over charge in amu
 - This effect is a direct consequence of the Busch Theorem that says that the azimuthal canonical particle momentum $p_\theta = mr^2\dot{\theta} + \frac{1}{2}qB(z)r^2$ is a constant of the motion in an axi-symmetric magnetic field (see appendix for more details)

Experimental beam emittance measurements

- Systematic experimental emittance measurements performed on Heavy Ion ECRIS confirms that Magnetic Emittance is dominant
 - VENUS Plot below
 - PHOENIX Plot right
 - Light ions emittances is consequently very large
- High intensity beams extracted ($I_{tot} \sim 3-15$ mA) induce space charge effects that inflate final beam emittance
 - PHOENIX Orange plot: 1 mA O^{6+} - Green: 0.5 mA O^{6+}
- The Emittances of High Charge states are smaller than expected

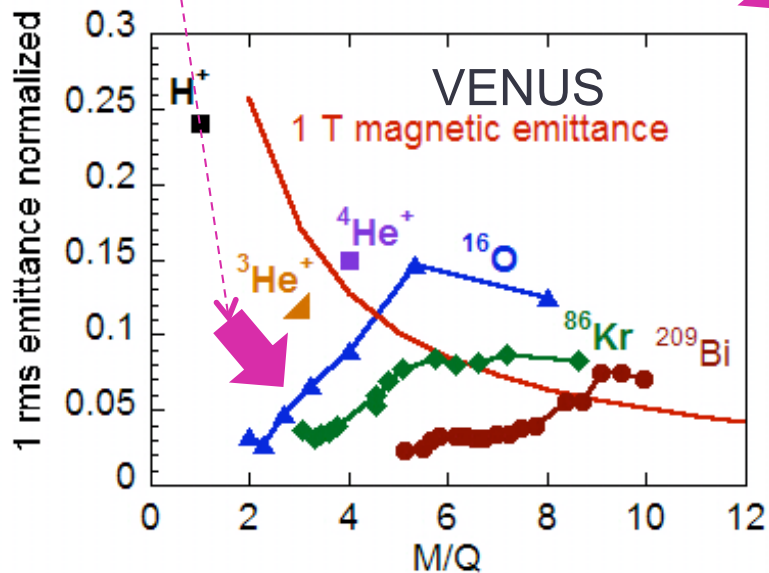
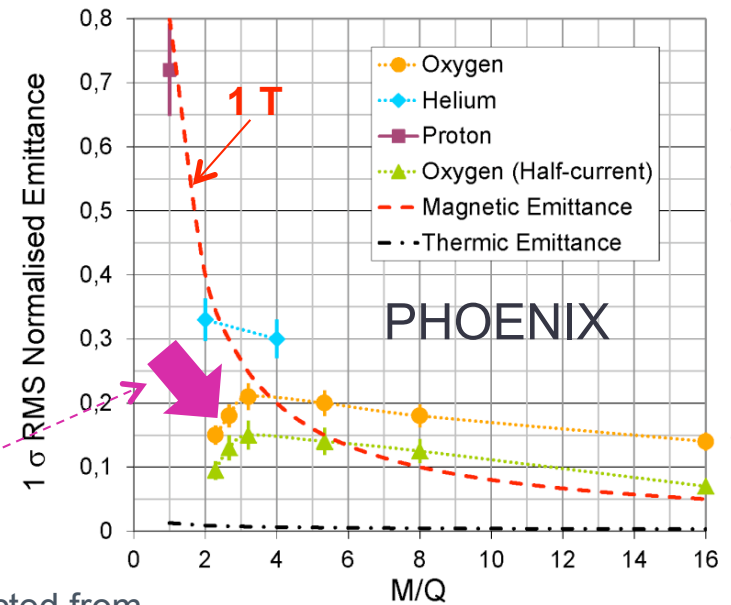

Source: D. Winklehner, LBNL, ECRIS2010

- High charge state ions are extracted from a radius lower than the plasma electrode one => Magnetic emittance reduction
- Effect due to the potential dip (generated by hot confined electrons) that confine electrostatically the ions near the ECRIS axis
- Experimental evidences exist of small triangular beams for high charge state

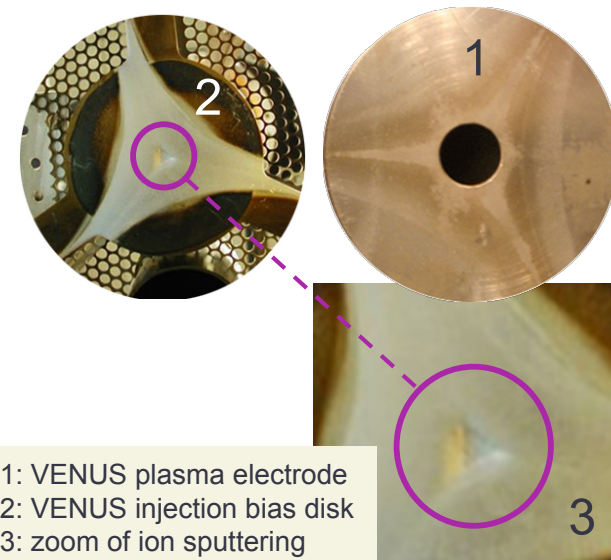
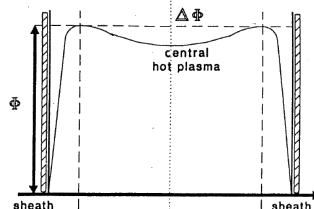

High intensity ECRIS Extractor

- ECR ion sources used to extract $I \sim 1-2$ mA of Ion beams, with a low divergence and negligible space charge effects
 - Classical extraction feature diode system with a plasma electrode and a grounded puller (as shown earlier)
- New generation high performance ECRIS produce high intensity beams of multicharged ions: the total current extracted increases typically to the range $I \sim 2-20$ mA where the space charge is highly dominant
- ECRIS extractor was modified to a **Triode system** used for decades in high current $1+$ sources

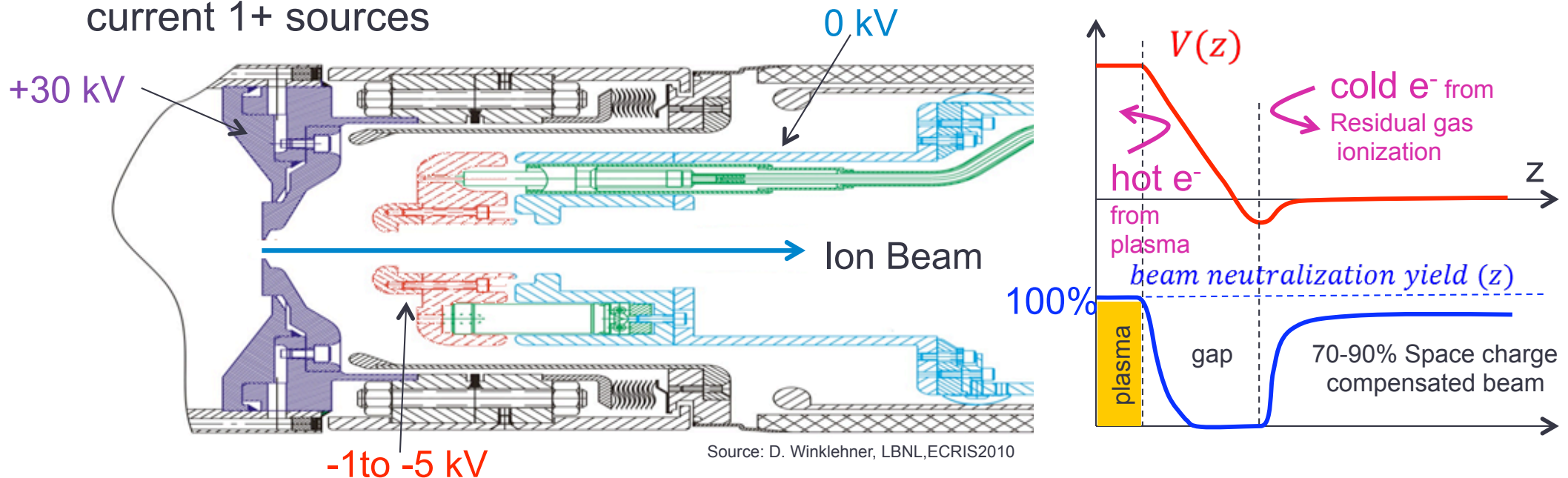

ECRIS requirements for Beam separation and transport

- The ECRIS beams are composed of several charge states of several atomic species. These beams are extracted all together, and their number is in the range ~ 10 -50. A bending magnet with a mass separation $M/\delta M \sim 100$ is necessary to cleanly separate the beam of interest from its M/Q neighbours.
- The dramatic increase of total current extracted from today high performance multicharged ECRIS (1~5-20 mA) requires a dedicated high performance Low Energy Beam Transfer Line, usually equipped at least with a focusing lens right at the exit of the source, a large acceptance beam line ($\varnothing_{\text{pipe}} \geq 100$ mm), and a large bending magnet (~ 100 mm vertical gap and a large ~ 200 mm horizontal aperture).

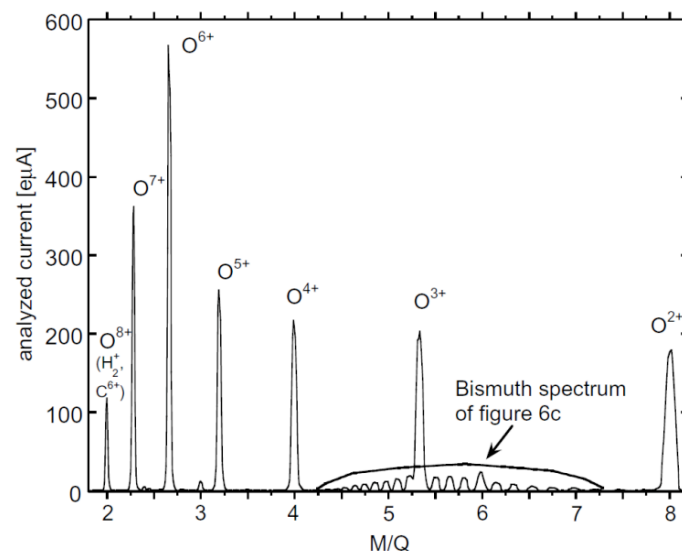
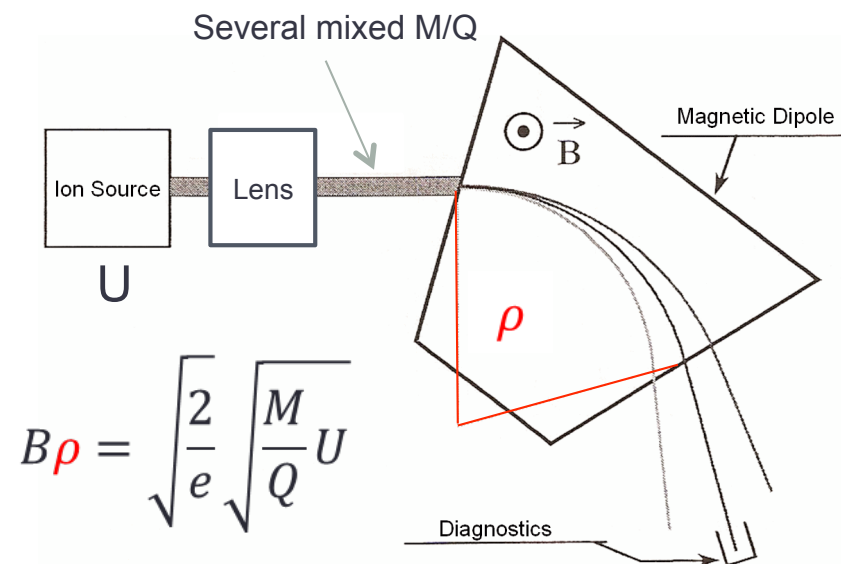

Example of an ion spectrum from VENUS, LBNL

NIMB 235 (2005) 486-493

Bibliography

- Ian G. Brown - The Physics and Technology of Ion Sources, Wiley & Sons, ISBN 3-527-40410-4
- R. Geller, Electron Cyclotron Resonance Ion Sources, ISBN 0-7503-0107-4
- Proceedings of the 19th International workshop on ECR Ion Sources, JACoW online proceedings. www.jacow.org
- Proceedings of the 18th International workshop on ECR Ion Sources, JACoW online proceedings. www.jacow.org
- Proceedings of the 11th International Conference on Ion Sources, Special Issue of Rev. of Sci. Instrum., Giardini Naxos, Italy, 2011
- Proceedings of the 10th International Conference on Ion Sources, Special Issue of Rev. of Sci. Instrum., Gatlinburg, USA, 2009
- Proceedings of the 9th International Conference on Ion Sources, Special Issue of Rev. of Sci. Instrum., Jeju, Republic of Korea, 2007
- ECR Ion Sources for Cyclotrons, C.M. Lyneis, October 1986, Presented at RCNP-Kikuchi Summer School on Accelerator Technology, Osaka, Japan, October 20-23, 1986, LBL-22450
- M. Moisans & J. Pelletier, Physique des Plasmas Collisionnels, Grenoble Science, ISBN 2 86883 822 7.
- Hamiltonian Analysis of Charged Particle Gyromotion in Cylindrical Coordinates, Naval Research Laboratory/MR/6750—07-9030.

Appendix

- Bush Theorem
- Motion of charged particule in E & B static field
- Plasma Sheath and Plasma Potential
- Plasma Wall Interactions
- Is there a limitation to ECR electron energy?

The Bush Theorem (emittance magnetization)

- The potential vector \vec{A} of a static axisymmetric magnetic Field \vec{B} can be integrated from $\vec{B} = \text{curl}(\vec{A})$:
 - $\vec{A} = \frac{1}{2}Br\vec{e}_\theta = A_\theta\vec{e}_\theta$
- The Lagrangian of a charged particle in such a magnetic field is (in cylindrical coordinates):
 - $L = \frac{1}{2}mv^2 + q\vec{A}\vec{v} = \frac{1}{2m}[\dot{r}^2 + r^2\dot{\theta}^2 + \dot{z}^2] + qA_\theta r\dot{\theta}$
- The Hamiltonian derived from this Lagrangian is:
 - $H = \frac{1}{2m}[(\frac{p_\theta}{r} - qA_\theta)^2 + p_z^2 + p_r^2]$
 - where $p_r = \partial L / \partial \dot{r}$, $p_z = \partial L / \partial \dot{z}$, $p_\theta = \partial L / \partial \dot{\theta}$ are the associated canonical momentum
- $\dot{H} = 0 \rightarrow$ the energy is constant in a magnetic field
- Most important: since H is not depending on θ , a general property can be derived:
 - $\dot{p}_\theta = -\frac{\partial H}{\partial \theta} = 0 \rightarrow p_\theta = \text{const}$
- $p_\theta = \frac{\partial L}{\partial \dot{\theta}} = mr^2\dot{\theta} + \frac{1}{2}qBr^2 = \text{const}$ **THIS IS THE BUSH THEOREM**
 - On the plasma electrode, an ion is extracted at $r = r_0$ and $B = B_0$; Since the ions are cold in the source ($T_i \sim 300$ K), the initial ion velocity is negligible with respect to $\frac{1}{2}qBr^2$
 - So $p_{\theta 0} = mr_0^2\dot{\theta}_0 + \frac{1}{2}qB_0r_0^2 \sim \frac{1}{2}qB_0r_0^2$
- Once accelerated in the beam line where $B \rightarrow 0$, the azimuthal momentum becomes:
 - $p_\theta \rightarrow mr^2\dot{\theta} = \frac{1}{2}qB_0r_0^2$

Motion of a particle in a static Magnetic and Electric Field

• Motion with $\mathbf{B} \parallel \mathbf{E}$

$$\bullet \quad m \frac{d\vec{v}}{dt} = q\vec{v} \times \vec{B} + \vec{E} \rightarrow \begin{cases} m \frac{d\vec{v}_\perp}{dt} = q\vec{v}_\perp \times \vec{B} \\ m \frac{dv_\parallel}{dt} = qE \end{cases} \rightarrow \begin{cases} \text{rotation with } v_\perp = \rho\omega \\ v_\parallel = \frac{qEt}{m} \end{cases}$$

- \rightarrow helix with radius ρ , angular frequency ω , variable pitch $p = \frac{2\pi v_\parallel(t)}{\omega}$

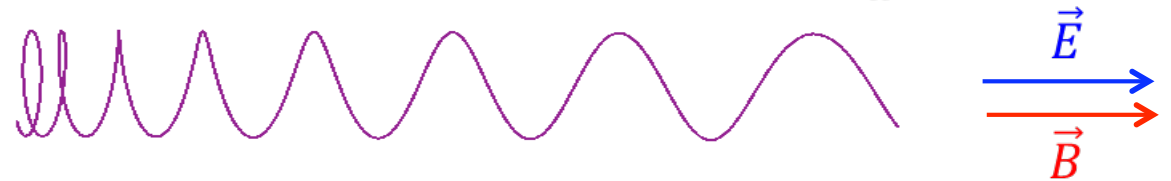

• Motion with $\mathbf{B} \perp \mathbf{E}$

$$\bullet \quad m \frac{d\vec{v}}{dt} = q\vec{v} \times \vec{B} + \vec{E} \rightarrow \vec{v} = \frac{E}{B} (\cos \omega t \cdot \vec{e}_{\perp 1} + \sin \omega t \cdot \vec{e}_{\perp 2}) - \frac{E}{B} \cdot \vec{e}_{\perp 1}$$

$$\bullet \quad \text{with } \vec{e}_{\perp 1} = \frac{\vec{E} \times \vec{B}}{EB} \text{ and } \vec{e}_{\perp 2} = \frac{\vec{E}}{E}$$

- \rightarrow a cycloid with a drift velocity $\vec{v}_D = \frac{\vec{E} \times \vec{B}}{B}$

- T_{kin} is not constant!



The Plasma Sheath and The Plasma Potential

- In a laboratory plasma, the presence of walls forces the Plasma to auto-adapt to keep its global quasi-neutrality
- The whole plasma globally charges to reach the **Plasma Potential** $V_p > 0$ to slow down electrons and accelerate ions to the wall in the **Plasma Sheath**
 - The sheath width is $\sim \lambda_D$ (Debye Length)
 - $V_p \sim 1 - 50$ Volts
- The plasma sheath is not neutral and an electric field $E \sim V_p / \lambda_D$ acts on particles
- In the plasma:
 - $n_e = n_i$, $v_i \ll v_e$, so $\varphi_i \ll \varphi_e$
- In the Sheath:
 - $\varphi_i = n_i(x)v_i(x) = \varphi_e = n_e(x)v_e(x)$

• The Bohm Criterion

- A stable sheath implies the presence of a pre-sheath where the plasma is still neutral but local potential and densities starts to decrease linearly.
- Bohm has shown that the ultimate ion velocity at the boundary of the neutral plasma is :

$$v_g \geq \sqrt{kT_e/m_i}$$

- This value should be used as an initial condition to simulate ion beam extraction from an ion source

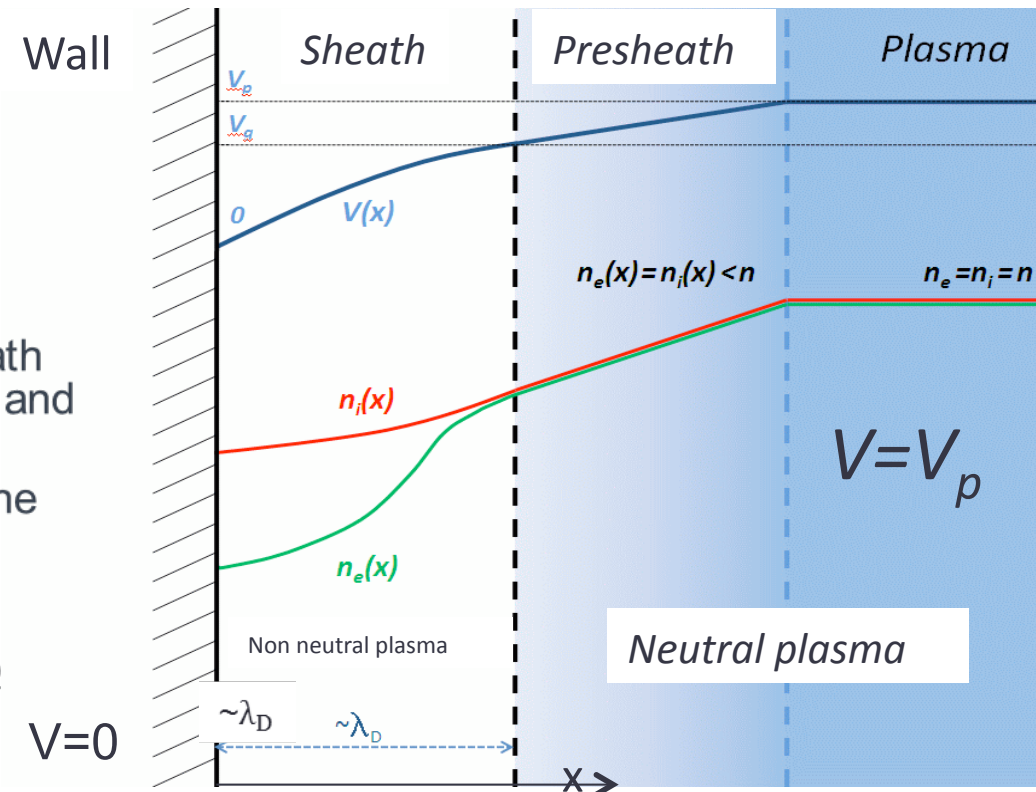

Plasma-Wall interactions

Secondary Electron Emission

- Impinging electrons to the wall generate secondary electrons flux that are accelerated toward the plasma
 - Excellent feedback effect on plasma density
 - The Yield Strongly depends on material

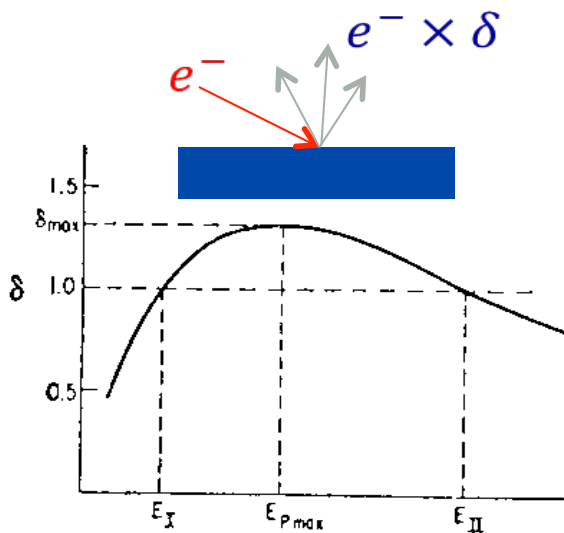

Secondary electron Yield δ vs primary electron energy

Source J. Arianer, IPNO

Element	δ_{\max}	E_p (eV)
Cu	1.3	600
Fe	1.3	600
Pt	1.8	700
Ta	1.3	600
W	1.4	650
Compound	δ_{\max}	E_p (eV)
Nal (crystal)	19	1300
Al ₂ O ₃ (layer)	2 - 9	
MgO (crystal)	20 - 25	1500

Ion Sputtering

- Ions escaping the plasma are accelerated in the sheath to $E = ZV_p$ eV
 - Atoms are sputtered and contaminate the plasma
 - A high concern in Tokamak...

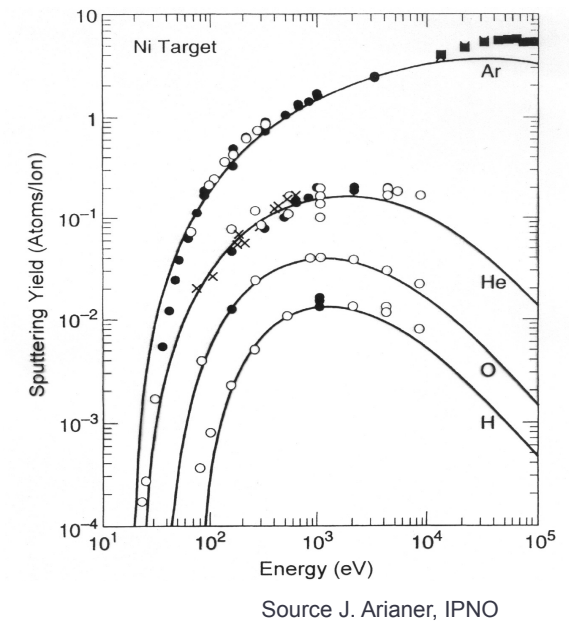
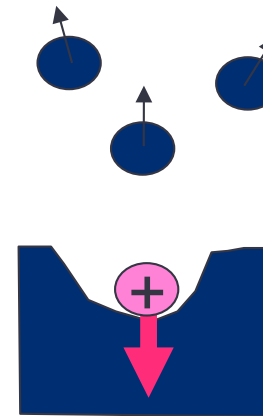

Is there a limitation to electron energy in ECR?

- Electron impact collision cools down electrons
- The time of confinement limits *de facto* the electrons energy which ALWAYS finish to the wall
- Relativity limit
 - When the electron kinetic energy increases, the cyclotronic frequency becomes $\omega \rightarrow \frac{\omega}{\gamma}$, γ Lorentz factor
 - So $B_{ECR} \rightarrow \frac{B_{ECR}}{\gamma}$, so γ would be limited to the minimum magnetic field value inside the ECR plasma (usually $B_{min} \sim 0.5 - 0.7 \times B_{ECR}$, so $\gamma_{max} \sim 2$)
- Stochastic breaking
 - When the helix trajectory pitch of the electron is approaching the order of magnitude of the plasma length in an ECR trap, the condition of stochastic heating is broken, since the phase may not be randomized anymore