

RF LINACS

Alessandra Lombardi BE/ ABP CERN

Credits

- much of the material is taken directly from **Thomas Wangler** USPAS course (http://uspas.fnal.gov/materials/SNS_Front-End.ppt.pdf) and **Mario Weiss** and **Pierre Lapostolle** report (**Formulae and procedures useful for the design of linear accelerators, from CERN doc server**)
- from previous linac courses at CAS and JUAS by **Erk Jensen, Nicolas Pichoff, Andrea Pisent, Maurizio Vretenar** , (<http://cas.web.cern.ch/cas>)

Contents

- PART 1 (today) :
 - Introduction : why? ,what?, how? , when?
 - Building bloc I (1/2) : Radio Frequency cavity
 - From an RF cavity to an accelerator

- PART 2 (tomorrow) :
 - Building bloc II (2/2) : quadrupoles and solenoids
 - Single particle beam dynamics
 - Collective effects brief examples : space charge and wake fields.

What is a linac

- **LIN**ear **AC**celerator : single pass device that increases the energy of a charged particle by means of a (radio frequency) electric field.
- Motion equation of a charged particle in an electromagnetic field

$$\frac{d\vec{p}}{dt} = q \cdot \left(\vec{E} + \vec{v} \times \vec{B} \right)$$

$\vec{p} = \text{momentum} = \gamma m_0 \vec{v}$

$q, m_0 = \text{charge, mass}$

$\vec{E}, \vec{B} = \text{electric, magnetic field}$

$t = \text{time}$

$\vec{x} = \text{position vector}$

$\vec{v} = \frac{d\vec{x}}{dt} = \text{velocity}$

What is a linac-cont'ed

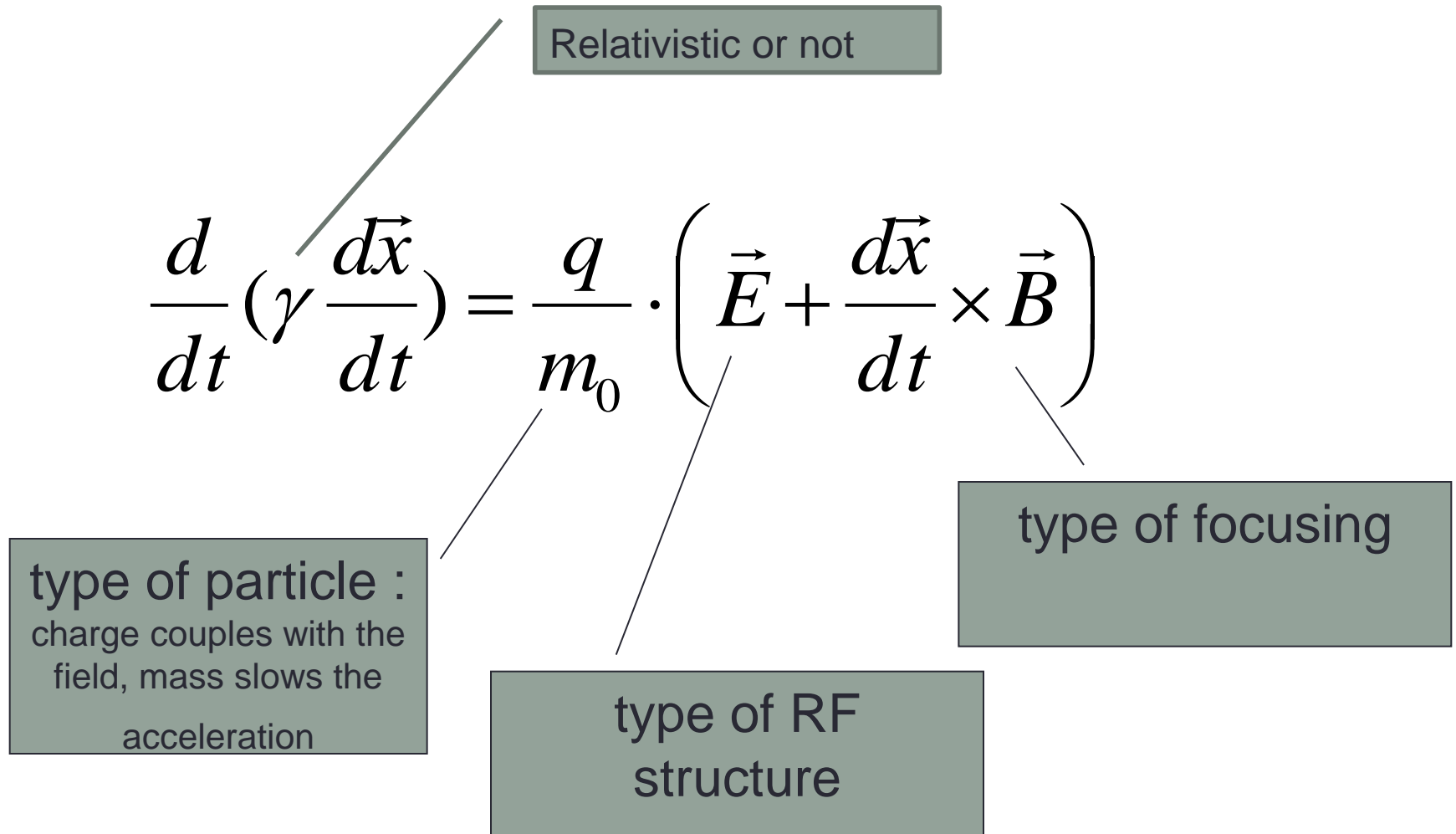

Type of particles : light or heavy

(electrons/muons)

Electron mass 0.511 MeV

(protons and ions)

Proton Mass 938.28 MeV

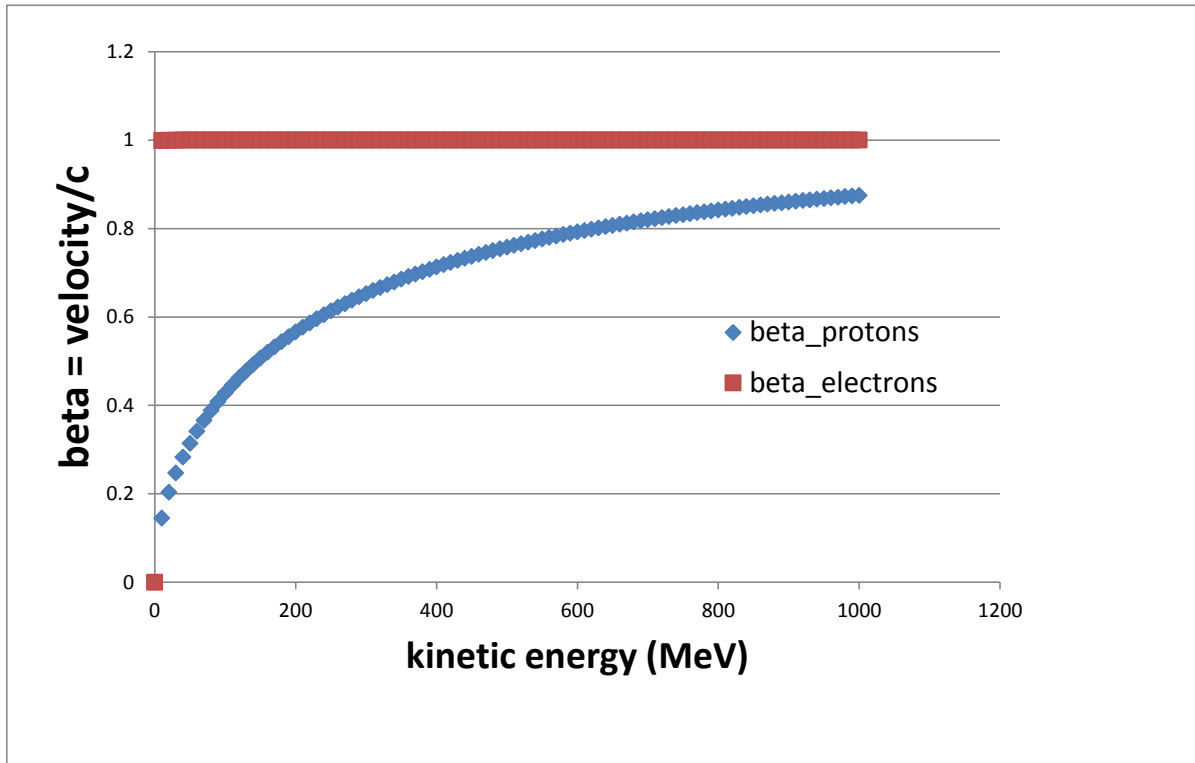

Electrons are quickly relativistic and easi(er) to accelerate

Reminder :

$$\frac{d\gamma}{dE_{kin}} \div \frac{1}{mass}$$

Electrostatic field

750 kV Cockcroft-Walton

- Linac2 injector at CERN from 1978 to 1992.



When ? A short history

- Acceleration by **time varying** electromagnetic field overcomes the limitation of static acceleration
- First experiment towards an RF linac : Wideroe linac 1928 on a proposal by Ising dated 1925. A bunch of potassium ions were accelerated to 50 keV in a system of drift tubes in an evacuated glass cylinder. The available generator provided 25 keV at 1 MHz.
- First realization of a linac : 1931 by Sloan and Lawrence at Berkeley laboratory
- From experiment to a practical accelerator : Wideroe to Alvarez
 - to proceed to higher energies it was necessary to increase by order of magnitude the frequency and to enclose the drift tubes in a RF cavity (resonator)
 - this concept was proposed and realized by Luis Alvarez at University of California in 1955 : A 200 MHz 12 m long Drift Tube Linac accelerated protons from 4 to 32 MeV.
 - the realization of the first linac was made possible by the availability of high-frequency power generators developed for radar application during World War

principle of an RF linac

- 1) **RF power source**: generator of electromagnetic wave of a specified frequency. It feeds a
- 2) **Cavity**: space enclosed in a metallic boundary which resonates with the frequency of the wave and tailors the field pattern to the
- 3) **Beam**: flux of particles that we push through the cavity when the field is maximized as to increase its
- 4) **Energy**.

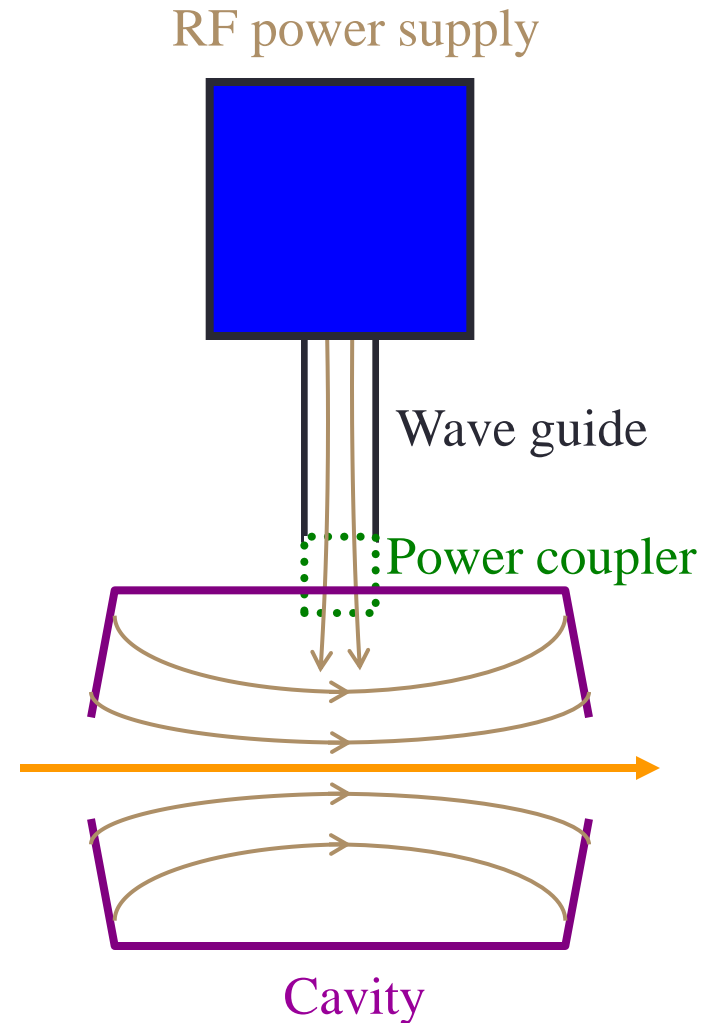

designing an RF LINAC

- cavity design : 1) control the field pattern inside the cavity; 2) minimise the ohmic losses on the walls/maximise the stored energy.
- beam dynamics design : 1) control the timing between the field and the particle, 2) insure that the beam is kept in the smallest possible volume during acceleration

tomorrow

electric field in a cavity

- assume that the solution of the wave equation in a bounded medium can be written as

$$\mathbf{E}(x, y, z, t) = \mathbf{E}(x, y, z) \cdot e^{-j\omega t}$$

function of space

function of time oscillating
at freq = $\omega/2\pi$

- cavity design step 1** : concentrating the RF power from the generator in the area traversed by the beam in the most efficient way. i.e. tailor $\mathbf{E}(x,y,z)$ to our needs by choosing the appropriate cavity geometry.

cavity geometry and related parameters definition

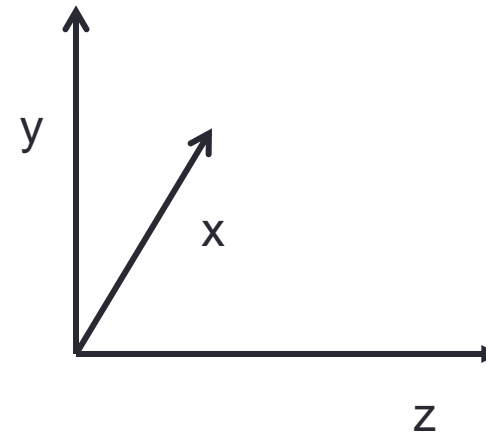
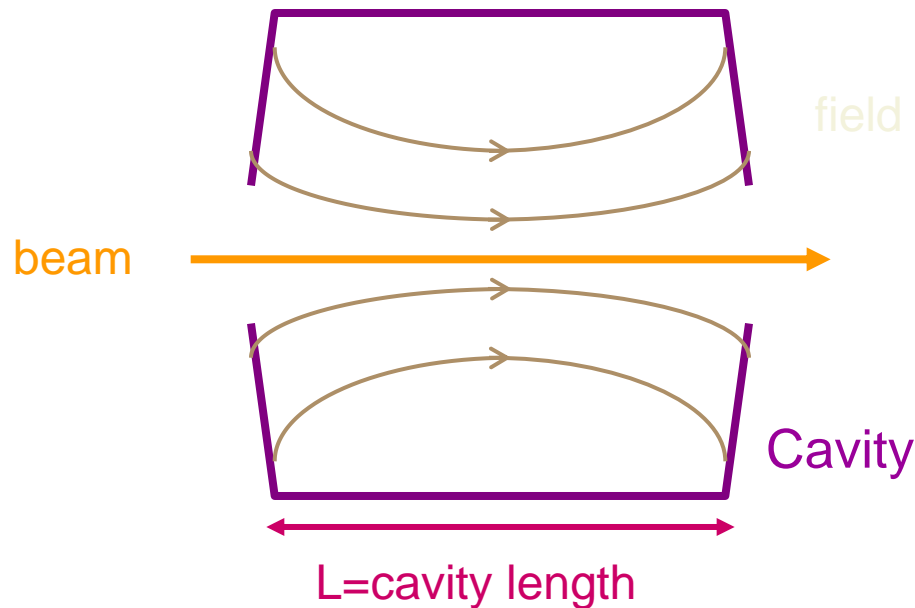

- 1-Average electric field
- 2-Shunt impedance
- 3-Quality factor
- 4-Filling time
- 5-Transit time factor
- 6-Effective shunt impedance

standing vs. traveling wave

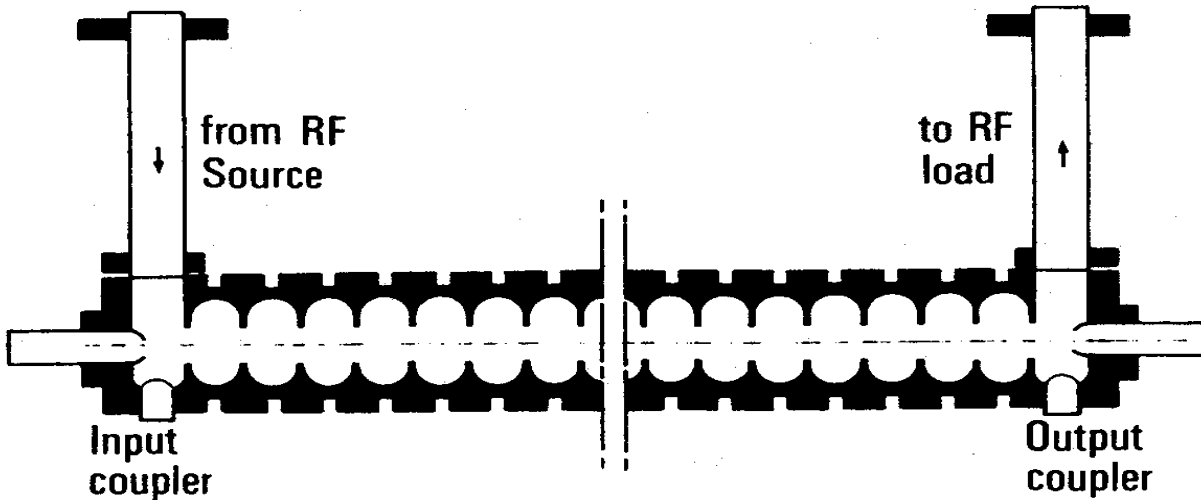

Standing Wave cavity : cavity where the forward and backward traveling wave have positive interference at any point

cavity parameters-1

- **Average electric field** (E_0 measured in V/m) is the space average of the electric field along the direction of propagation of the beam in a given moment in time when $F(t)$ is maximum.

$$E(x, y, z, t) = E(x, y, z) \cdot e^{-j\omega t}$$

$$E_0 = \frac{1}{L} \int_0^L E_z(x=0, y=0, z) dz$$

- physically it gives a measure how much field is available for acceleration
- it depends on the cavity shape, on the resonating mode and on the frequency

cavity parameters-2

- **Shunt impedance** (Z measured in Ω/m) is defined as the ratio of the average electric field squared (E_0) to the power (P) per unit length (L) dissipated on the wall surface.

$$Z = \frac{E_0^2}{P} \cdot \frac{L}{P} \quad \text{or} \quad Z = \frac{E_0^2}{dP} \cdot \frac{dL}{dP} \quad \text{for TW}$$

- Physically it is a measure of well we concentrate the RF power in the useful region .
- NOTICE that it is independent of the field level and cavity length, it depends on the cavity mode and geometry.
- beware definition of shunt impedance !!! some people use a factor 2 at the denominator ; some (other) people use a definition dependent on the cavity length.

cavity parameters-3

- **Quality factor** (Q dimension-less) is defined as the ratio between the stored energy (U) and the power lost on the wall (P) in one RF cycle (f=frequency)

$$Q = \frac{2 \cdot \pi \cdot f \cdot U}{P}$$

- Q is a function of the geometry and of the **surface resistance of the material** :

superconducting (niobium) : $Q = 10^{10}$

normal conducting (copper) : $Q = 10^4$

example at 700MHz

cavity parameters-3

- SUPERCONDUCTING Q depends on temperature :
 - $8 \cdot 10^9$ for 350 MHz at 4.5K
 - $2 \cdot 10^{10}$ for 700 MHz at 2K.
- NORMAL CONDUCTING Q depends on the mode :
 - 10^4 for a TM mode (Linac2=40000)
 - 10^3 for a TE mode (RFQ2=8000).

cavity parameters-4

- filling time (τ measured in sec) has different definition on the case of traveling or standing wave.
- TW : the time needed for the electromagnetic energy to fill the cavity of length L

$$t_F = \int_0^L \frac{dz}{v_g(z)}$$

velocity at which the energy propagates through the cavity

- SW : the time it takes for the field to decrease by $1/e$ after the cavity has been filled

$$t_F = \frac{2Q}{\omega}$$

measure of how fast the stored energy is dissipated on the wall

cavity parameters-5

- transit time factor (T , dimensionless) is defined as the maximum energy gain per charge of a particle traversing a cavity over the average voltage of the cavity.
- Write the field as

$$E_z(x, y, z, t) = E_z(x, y, z)e^{-i(\omega t)}$$

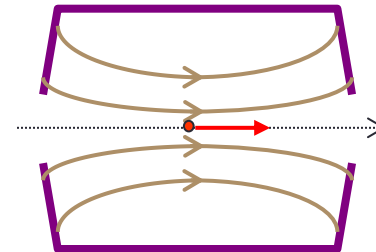

- The energy gain of a particle entering the cavity on axis at phase ϕ is

$$\Delta W = \int_0^L qE_z(o, o, z)e^{-i(\omega t + \phi)} dz$$

cavity parameters-5

- assume constant velocity through the cavity (APPROXIMATION!!) we can relate position and time via

$$z = v \cdot t = \beta ct$$

- we can write the energy gain as

$$\Delta W = qE_0 L T \cos(\phi)$$

- and define transit time factor as

$$T = \frac{\left| \int_0^L E_z(z) e^{-j\left(\frac{\omega z}{\beta c}\right)} dz \right|}{\int_0^L E_z(z) dz}$$

T depends on the particle velocity and on the gap length. IT DOESN'T depend on the field

cavity parameters-5

- NB : Transit time factor depends on x,y (the distance from the axis in cylindrical symmetry). By default it is meant the transit time factor on axis
- Exercise!!! If $E_z = E_0$ then

L=gap length

β =relativistic parametre

λ =RF wavelength

$$T = \frac{\sin\left(\frac{\pi L}{\beta\lambda}\right)}{\left(\frac{\pi L}{\beta\lambda}\right)}$$

cavity parameter-6

tff for 100 keV protons, 200 MHz., parabolic distribution

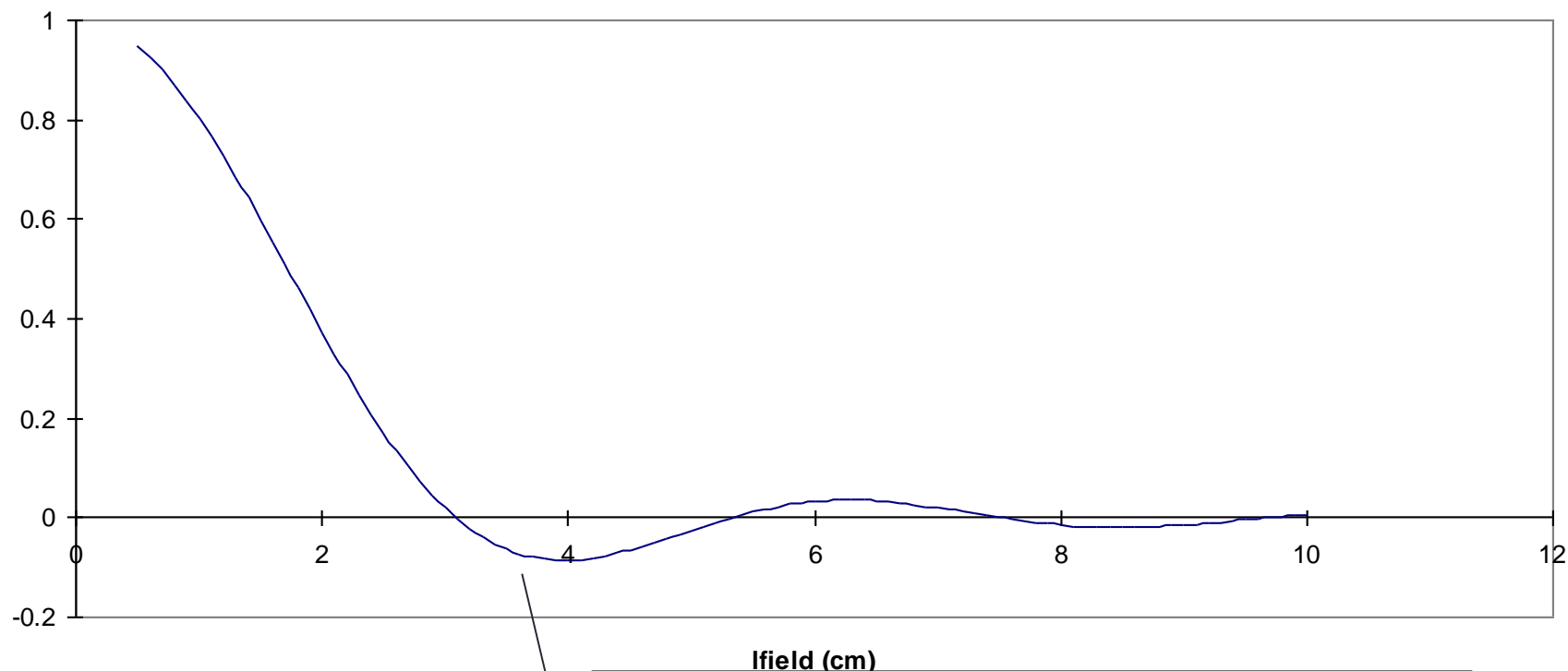

if we don't get the length right we can end up decelerating!!!

effective shunt impedance

- It is more practical, for accelerator designers to define cavity parameters taking into account the effect on the beam
- Effective shunt impedance Z_{TT}

$$Z = \frac{E_0^2}{P} \cdot L$$

measure if the structure design is optimized

$$Z_{TT} = \frac{(E_0 T)^2}{P} \cdot L$$

measure if the structure is optimized and adapted to the velocity of the particle to be accelerated

limit to the field in a cavity

- normal conducting :
 - heating
 - Electric peak field on the cavity surface (sparking)
- super conducting :
 - quenching
 - Magnetic peak field on the surface (in Niobium max 200mT)

Kilpatrick sparking criterion

(in the frequency dependent formula)

$$f = 1.64 E^2 \exp(-8.5/E)$$

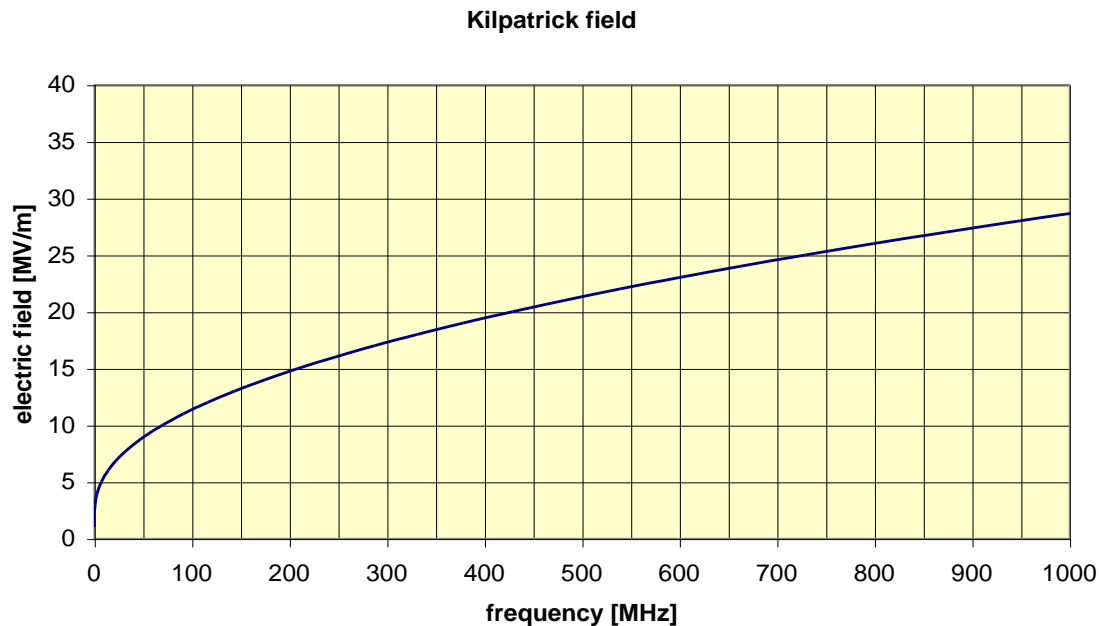

GUIDELINE

nowadays : peak
surface field up to
2*kilpatrick field

Quality factor for normal
conducting cavity is
 $E_{\text{peak}}/E_0 T$

wave equation -recap

- Maxwell equation for E and B field:

$$\left(\frac{\partial^2}{\partial x^2} + \frac{\partial^2}{\partial y^2} + \frac{\partial^2}{\partial z^2} - \frac{1}{c^2} \frac{\partial^2}{\partial t^2} \right) \vec{E} = 0$$

- In **free space** the electromagnetic fields are of the *transverse electro magnetic*, TEM, type: the electric and magnetic field vectors are \perp to each other and to the direction of propagation.
- In a **bounded medium** (cavity) the solution of the equation must satisfy the boundary conditions :

$$\begin{aligned} \vec{E}_{\parallel} &= \vec{0} \\ \vec{B}_{\perp} &= \vec{0} \end{aligned}$$

TE or TM modes

- TE (=transverse electric) : the electric field is perpendicular to the direction of propagation. in a cylindrical cavity

$$TE_{nml}$$

n : azimuthal,

m : radial

l longitudinal component

- TM (=transverse magnetic) : the magnetic field is perpendicular to the direction of propagation

$$TM_{nml}$$

n : azimuthal,

m : radial

l longitudinal component

TE modes

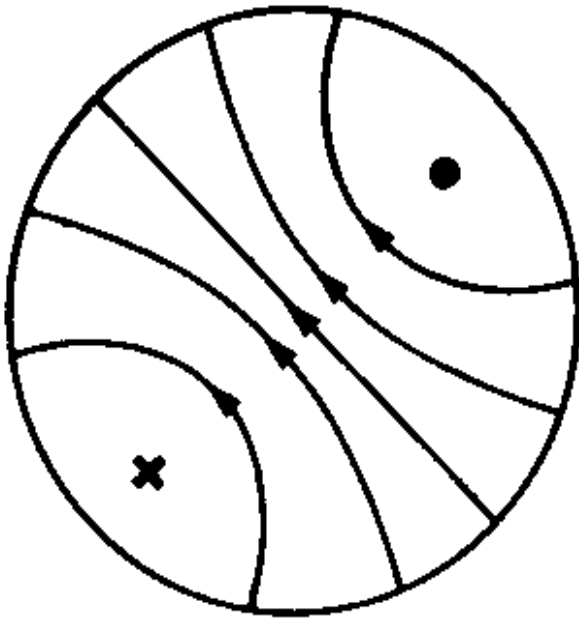

Empty cavity; mode TE_{11}

dipole mode

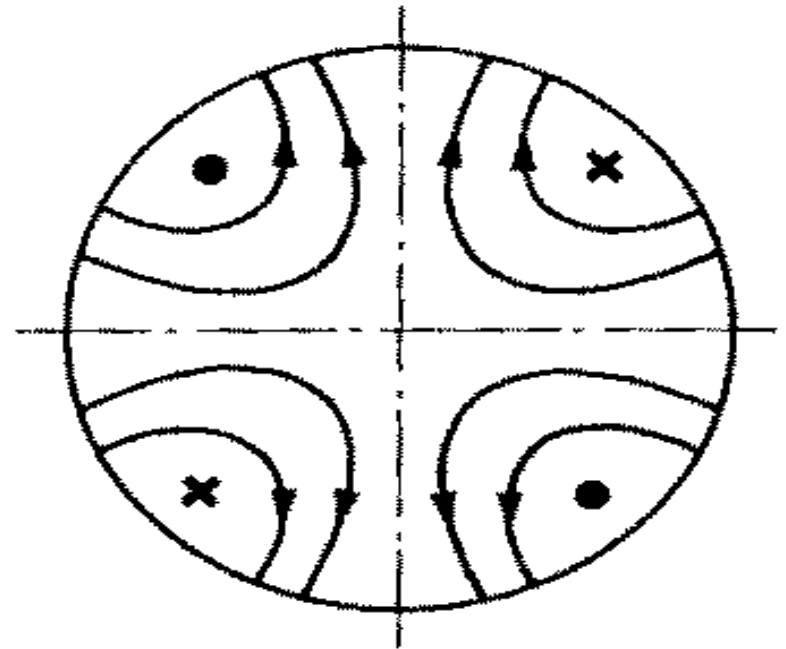

Empty cavity; mode TE_{21}

quadrupole mode used in
Radio Frequency Quadrupole

TM modes

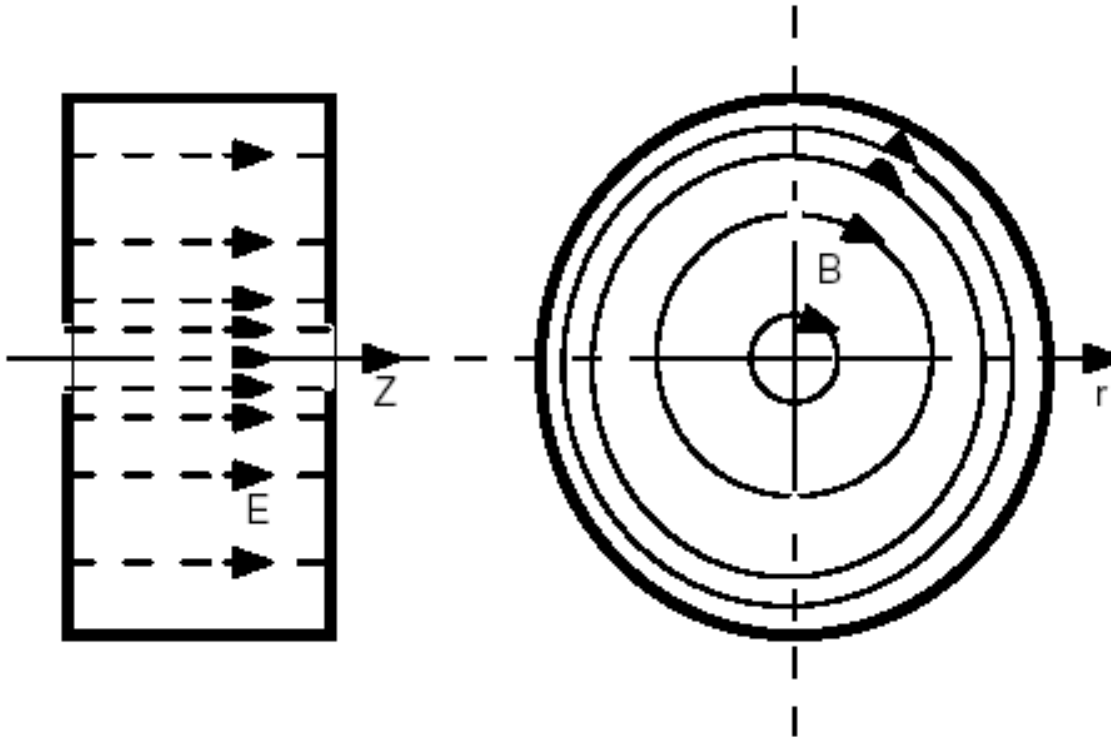

TM₀₁₀ mode , most commonly used
accelerating mode

cavity modes

- **0-mode** Zero-degree phase shift from cell to cell, so fields adjacent cells are in phase. Best example is DTL.
- **π -mode** 180-degree phase shift from cell to cell, so fields in adjacent cells are out of phase. Best example is multicell superconducting cavities.
- **$\pi/2$ mode** 90-degree phase shift from cell to cell. In practice these are biperiodic structures with two kinds of cells, accelerating cavities and coupling cavities. The CCL operates in a $\pi/2$ structure mode. This is the preferred mode for very long multicell cavities, because of very good field stability.

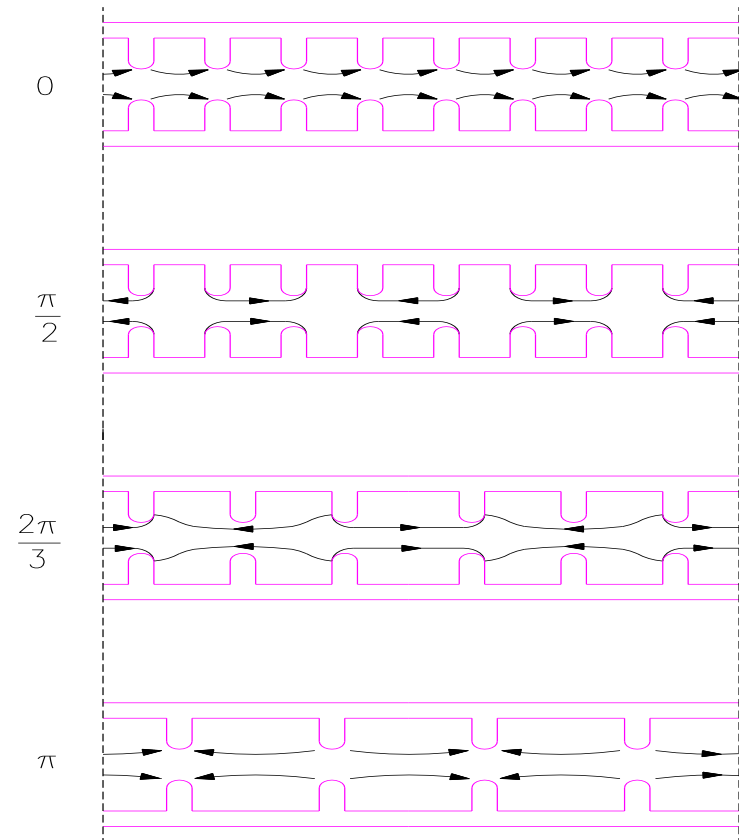

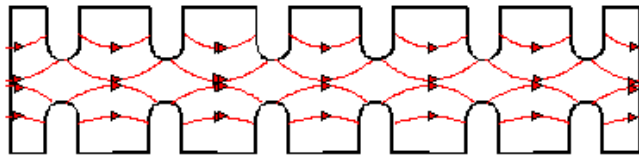

mode 0

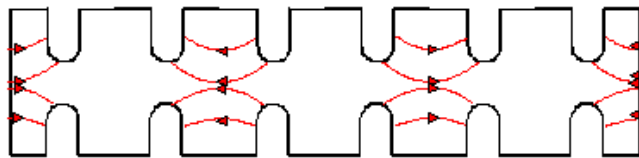
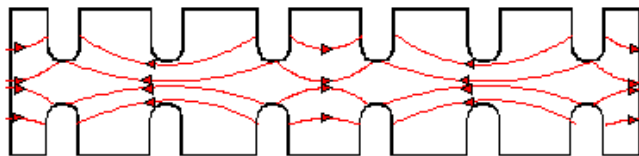
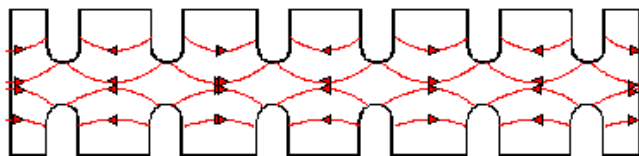
mode $\pi/2$ mode $2\pi/3$ mode π

Mode 0 also called mode 2π .

For synchronicity and acceleration, particles must be in phase with the E field on axis (will be discussed more in details later).

During 1 RF period, the particles travel over a distance of $\beta\lambda$.

The cell L length should be:

Mode	L
2π	$\beta\lambda$
$\pi/2$	$\beta\lambda/4$
$2\pi/3$	$\beta\lambda/3$
π	$\beta\lambda/2$

Named from the phase difference between adjacent cells.

Selection of accelerating structures

- Radio Frequency Quadrupole
- Interdigital-H structure
- Drift Tube Linac
- Side Coupled Linac

Radio Frequency Quadrupoles



transverse field in an RFQ

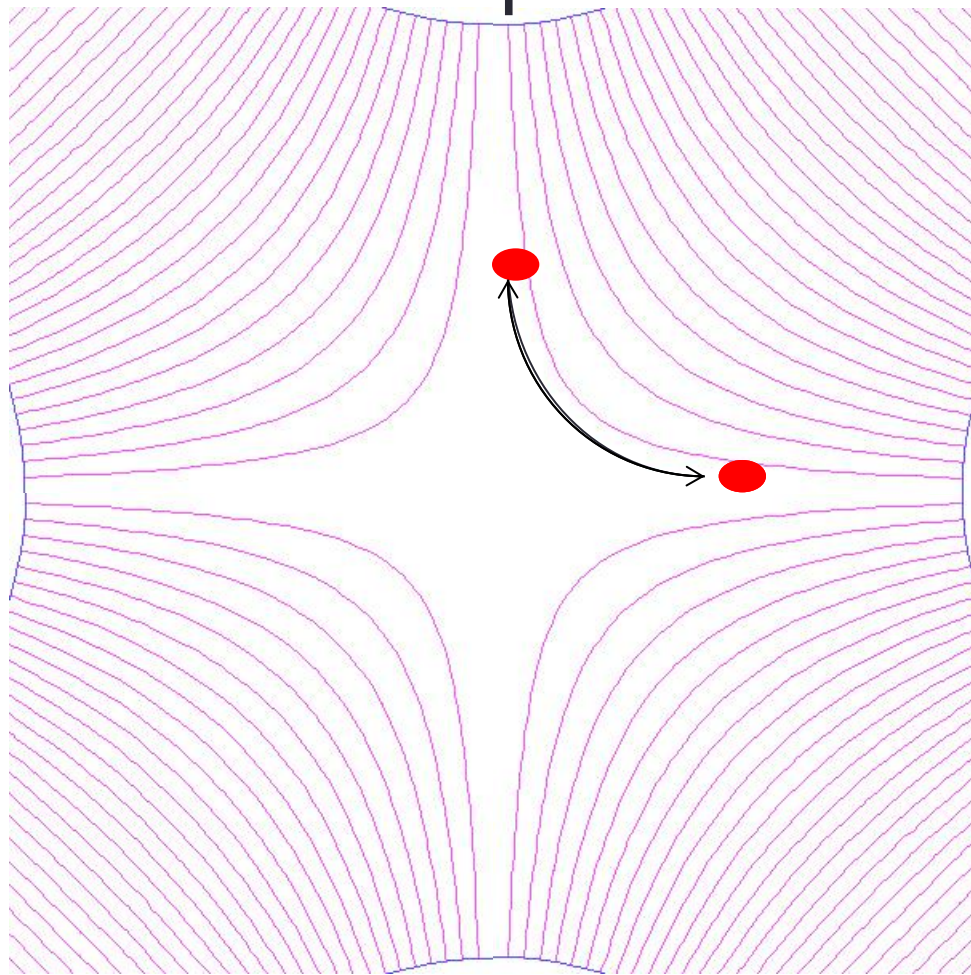

alternating gradient
focussing structure with
period length $\beta\lambda$
(in half RF period the
particles have travelled a
length $\beta\lambda/2$)

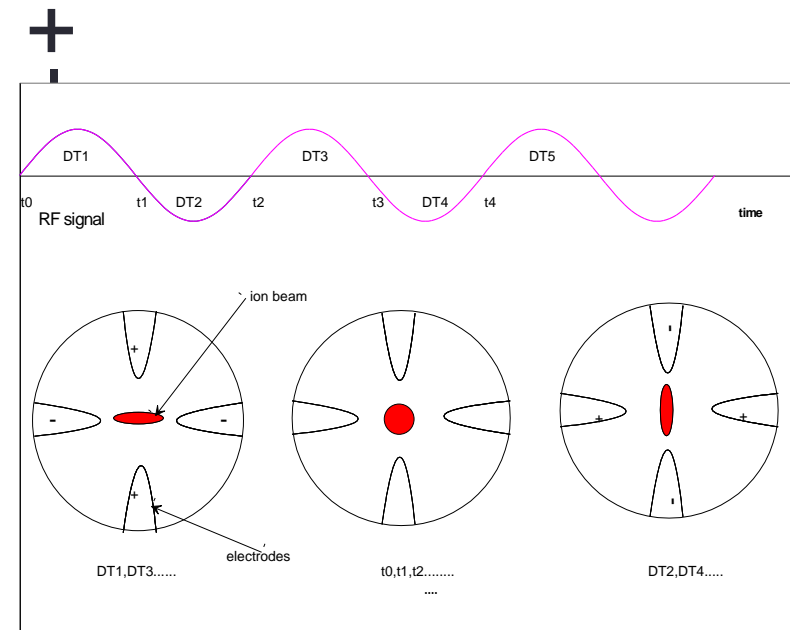

acceleration in RFQ

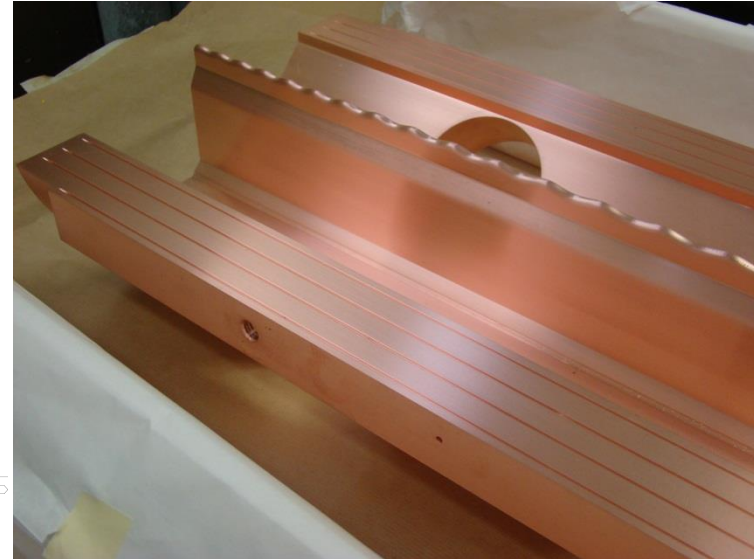
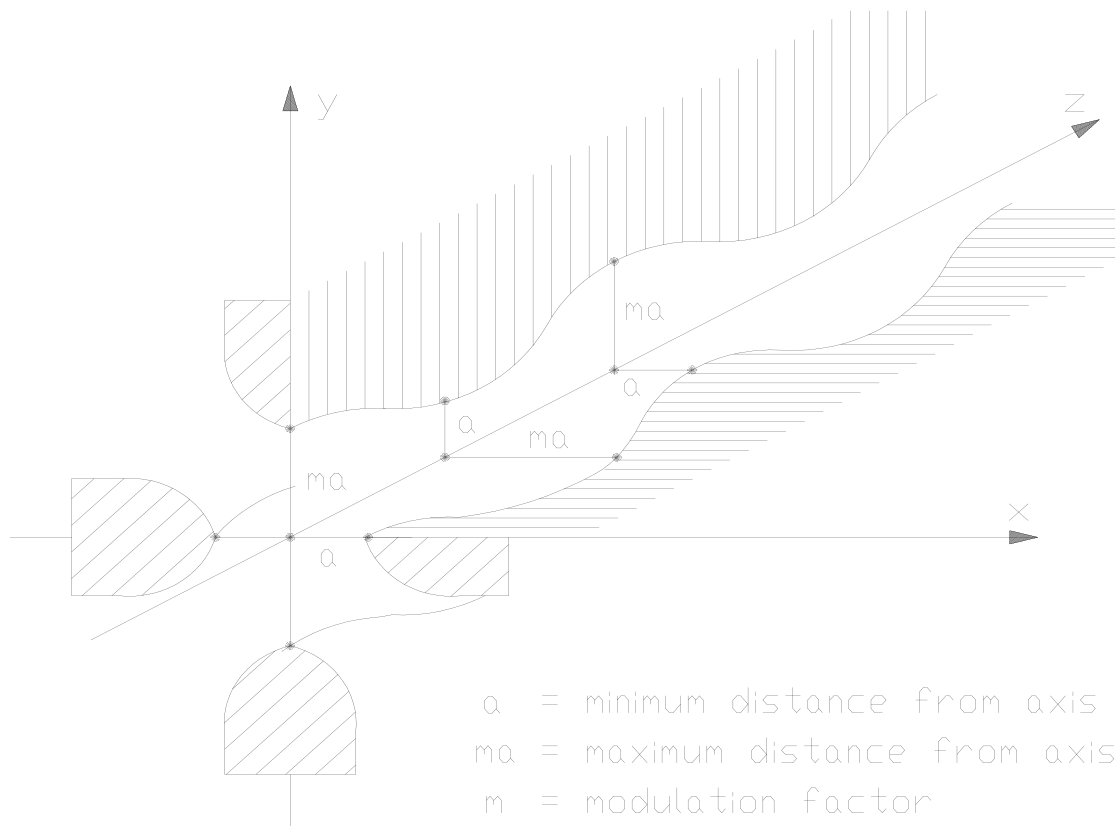

longitudinal modulation on the electrodes creates a longitudinal component in the TE mode

acceleration in an RFQ

$$\frac{\beta\lambda}{2} \left(1 - \frac{\Delta\varphi}{2\pi}\right)$$

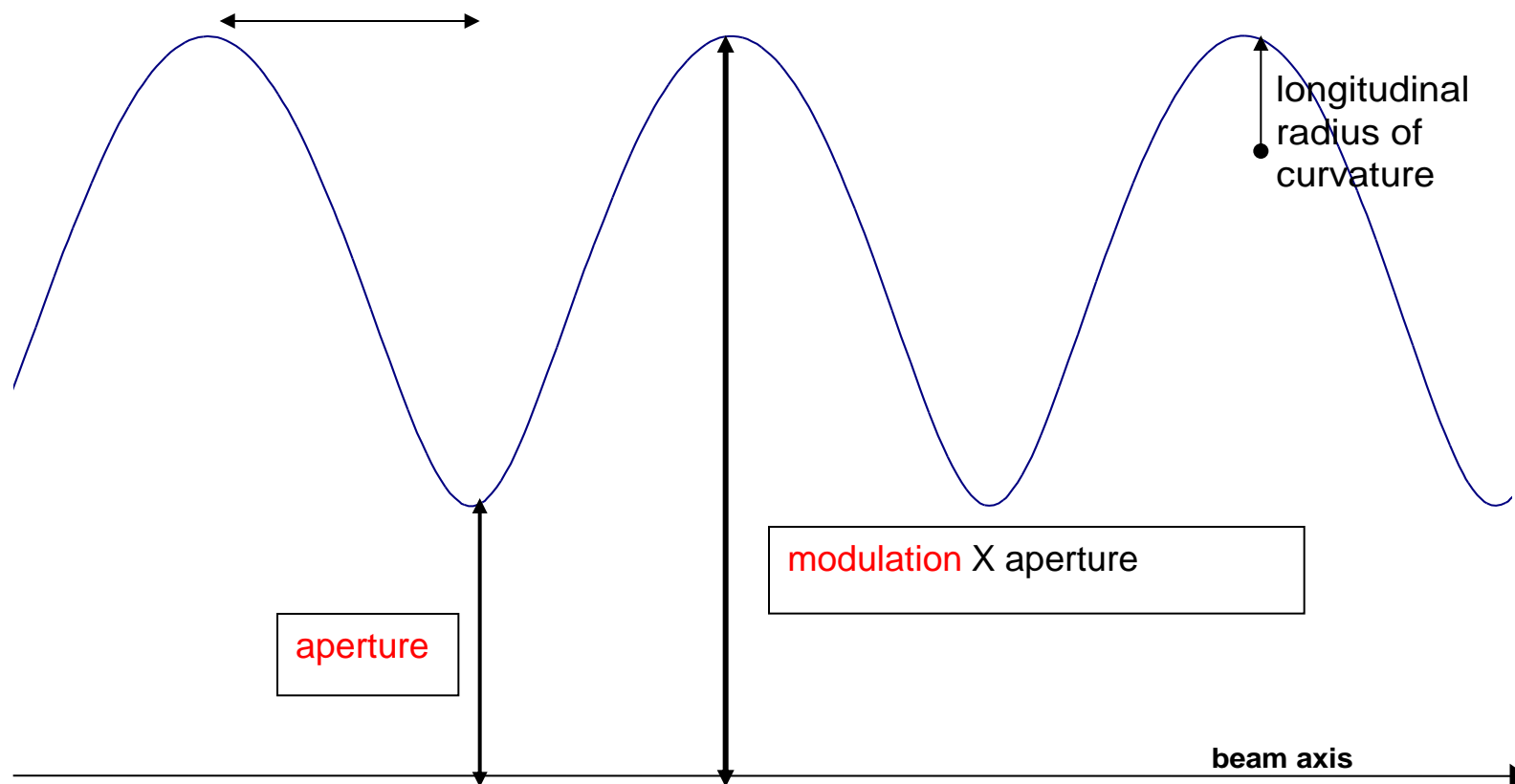

important parameters of the RFQ

$$B = \left(\frac{q}{m_0} \right) \left(\frac{V}{a} \right) \left(\frac{1}{f^2} \right) \frac{1}{a} \left(\frac{I_o(ka) + I_o(mka)}{m^2 I_o(ka) + I_o(mka)} \right)$$

type of
particle

limited by
sparking

Transverse field distortion due to
modulation (=1 for un-modulated
electrodes)

$$E_0 T = \frac{m^2 - 1}{m^2 I_o(ka) + I_o(mka)} \cdot V \frac{2}{\beta \cdot \lambda} \frac{\pi}{4}$$

Accelerating efficiency : fraction of the field
deviated in the longitudinal direction
(=0 for un-modulated electrodes)

cell
length

transit
time factor

.....and their relation

$$\left(\frac{I_0(ka) + I_0(mka)}{m^2 I_0(ka) + I_0(mka)} \right) + \frac{m^2 - 1}{m^2 I_0(ka) + I_0(mka)} \cdot I_0(ka) = 1$$

focusing
efficiency

accelerating
efficiency

a =bore radius, β, γ =relativistic parameters, c =speed of light, f = rf frequency, I_0, I_1 =zero, first order Bessel function, k =wave number, λ =wavelength, m =electrode modulation, m_0 =rest mass, q =charge, r = average transverse beam dimension, r_0 =average bore, V =vane voltage

RFQ

- The resonating mode of the cavity is a focusing mode
- Alternating the voltage on the electrodes produces an alternating focusing channel
- A longitudinal modulation of the electrodes produces a field in the direction of propagation of the beam which bunches and accelerates the beam
- Both the focusing as well as the bunching and acceleration are performed by the RF field
- The RFQ is the only linear accelerator that can accept a low energy CONTINUOUS beam of particles
- 1970 Kapchinskij and Teplyakov propose the idea of the radiofrequency quadrupole (I. M. Kapchinskii and V. A. Teplvakov, Prib.Tekh. Eksp. No. 2, 19 (1970))

Interdigital H structure



CNAO IH

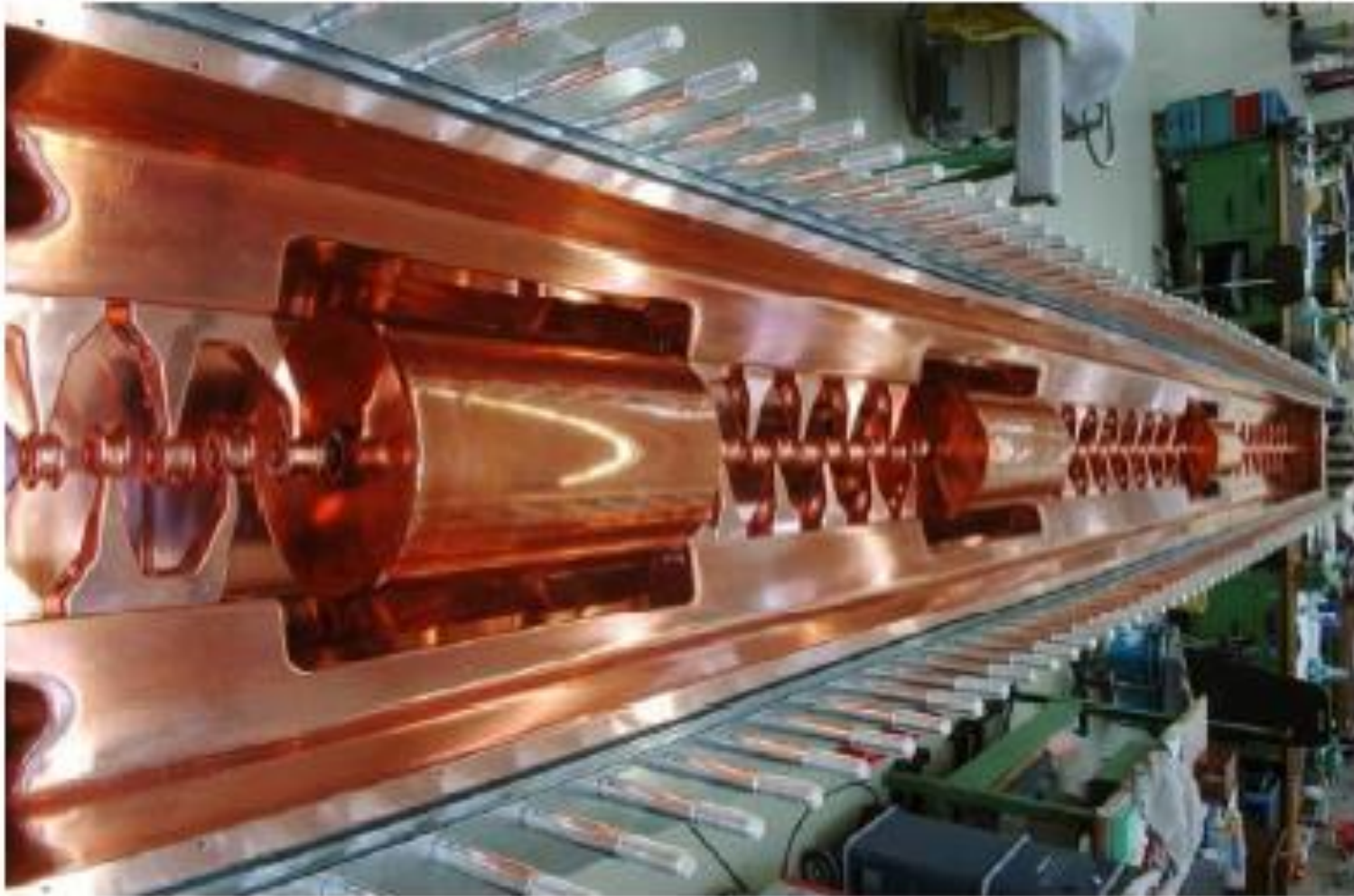

Interdigital H structure

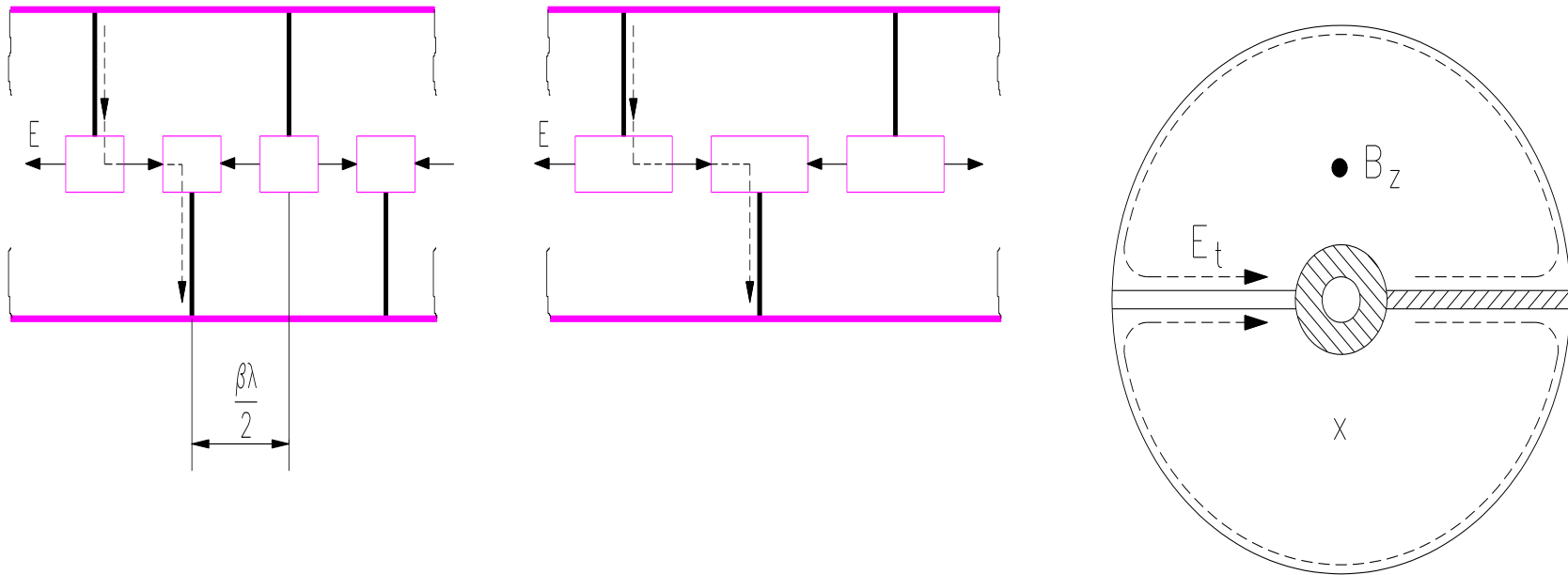

TE₁₁₀ mode

- stem on alternating side of the drift tube force a longitudinal field between the drift tubes
- focalisation is provided by quadrupole triplets places OUTSIDE the drift tubes or OUTSIDE the tank

IH use

- very good shunt impedance in the low beta region ($\beta \cong 0.02$ to 0.08) and low frequency (up to 200MHz)
- not for high intensity beam due to long focusing period
- ideal for low beta heavy ion acceleration

Drift Tube Linac

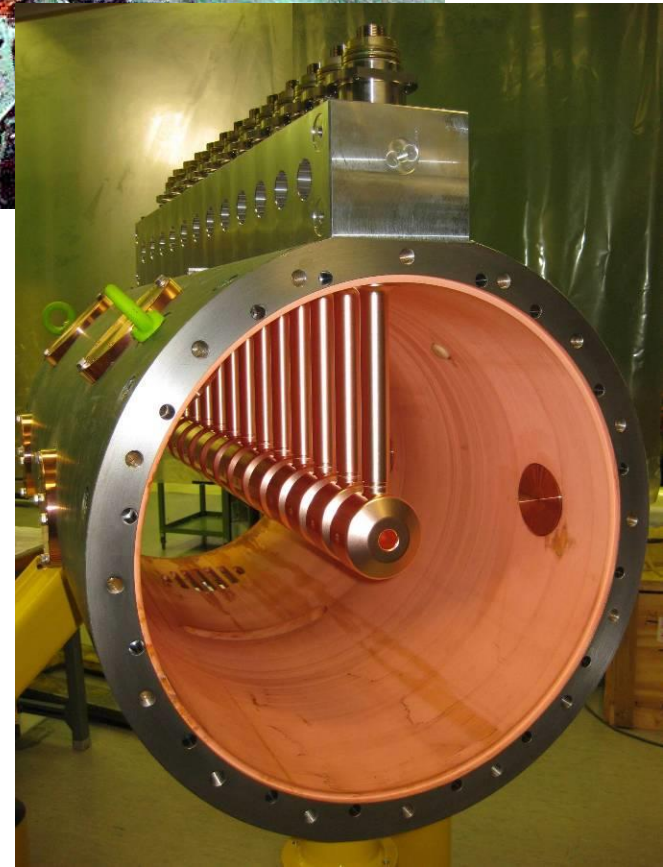
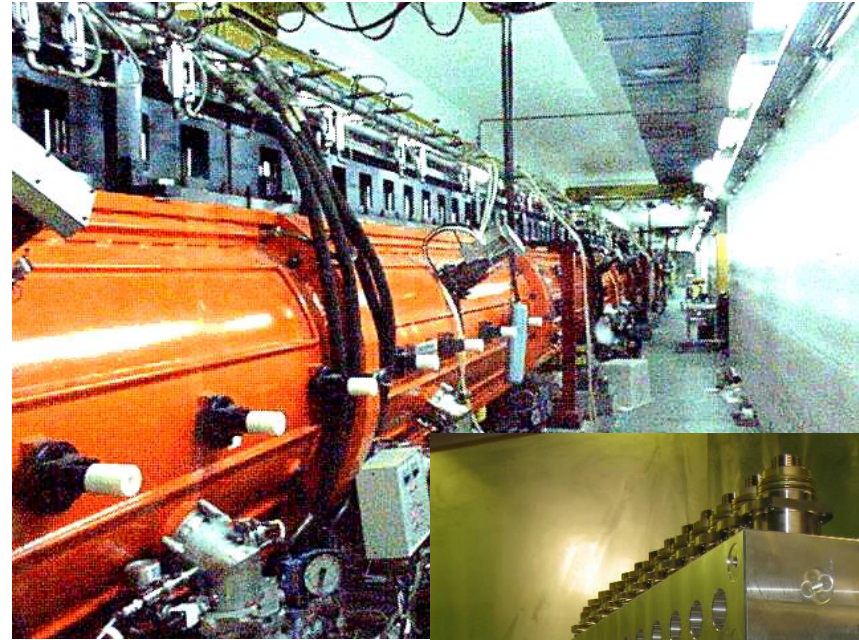
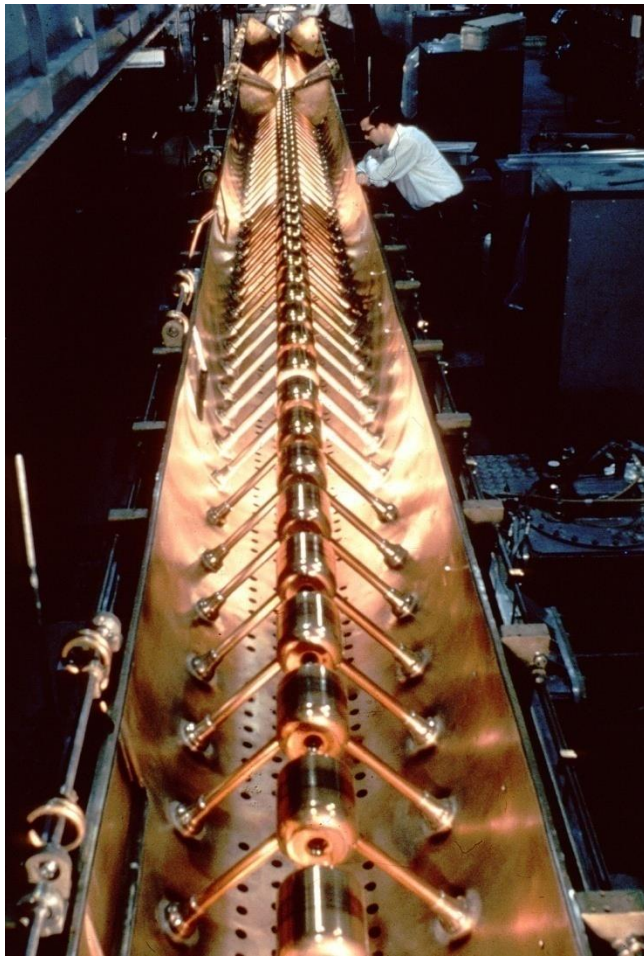

DTL – drift tubes

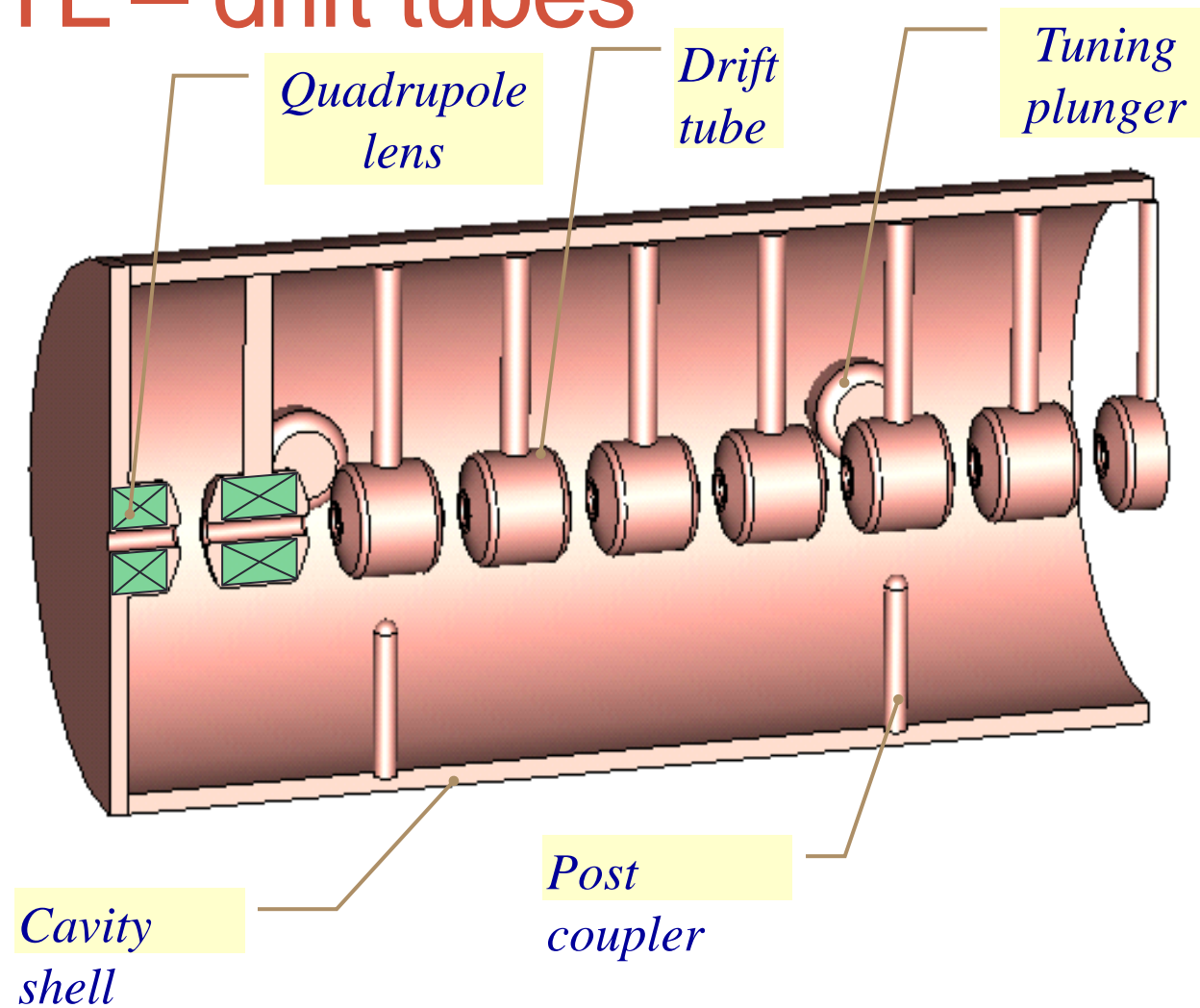

DTL : electric field

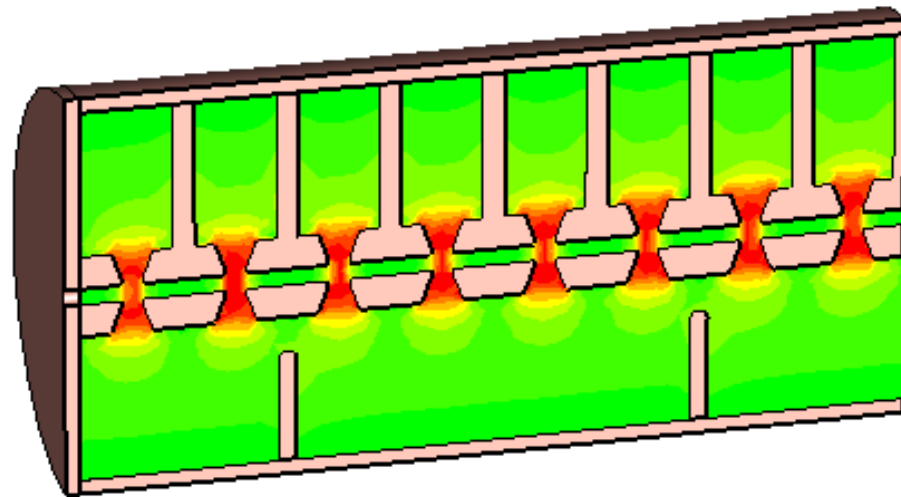
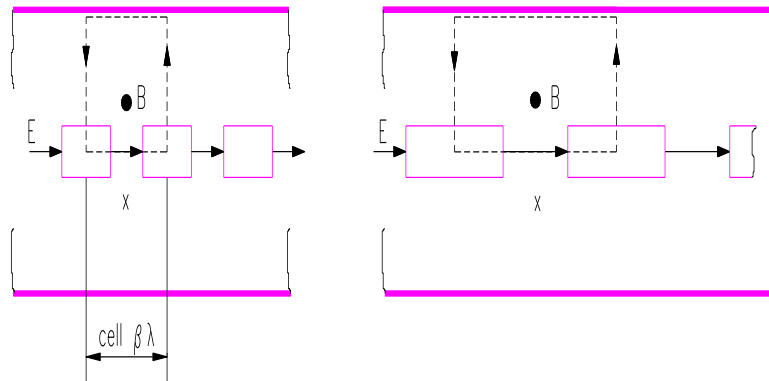

Mode is TM₀₁₀

DTL

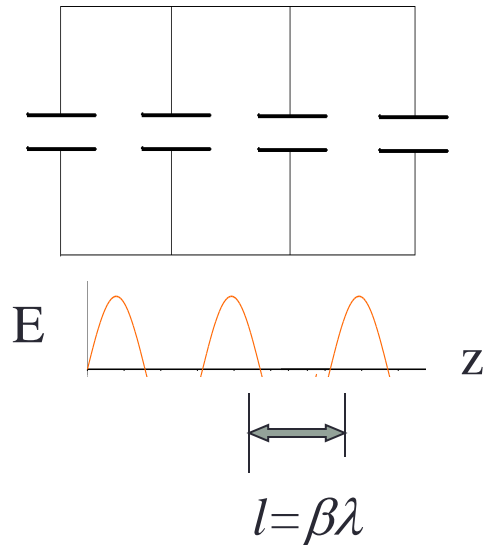

The DTL operates in **0 mode** for protons and heavy ions in the range $\beta=0.04-0.5$ (750 keV - 150 MeV)

Synchronism condition (0 mode):

$$l = \frac{\beta c}{f} = \beta\lambda$$

The beam is inside the “drift tubes” when the electric field is decelerating

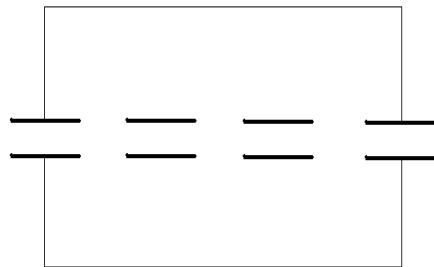

The fields of the 0-mode are such that if we eliminate the walls between cells the fields are not affected, but we have less RF currents and higher shunt impedance

RFQ vs. DTL

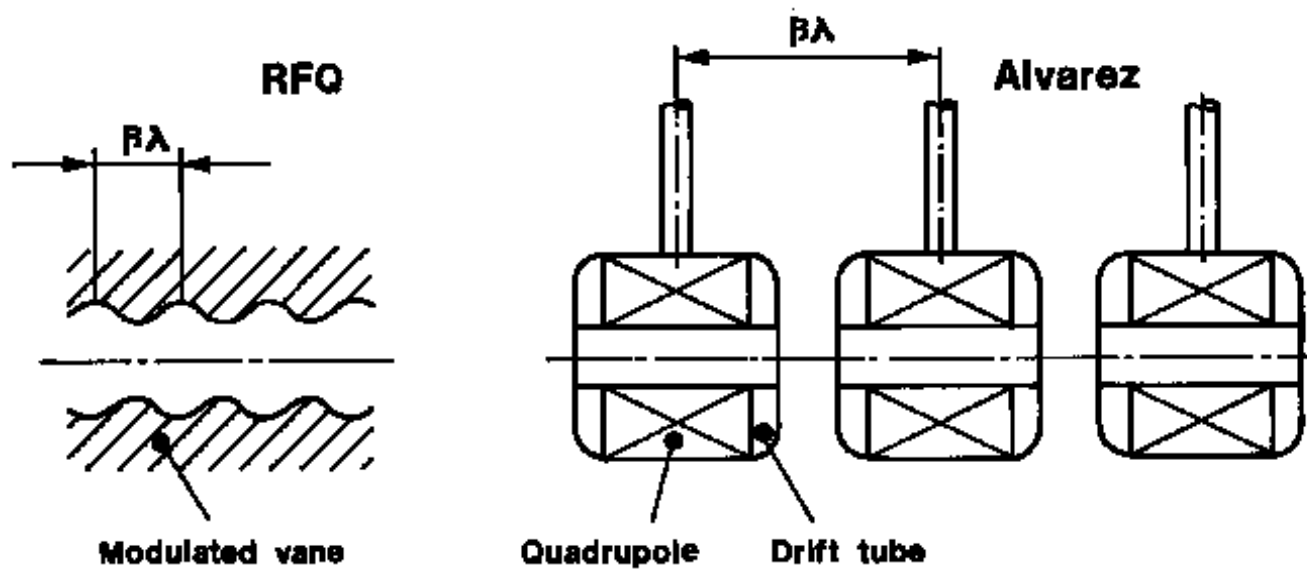

DTL can't accept low velocity particles, there is a minimum injection energy in a DTL due to mechanical constraints

Side Coupled Linac

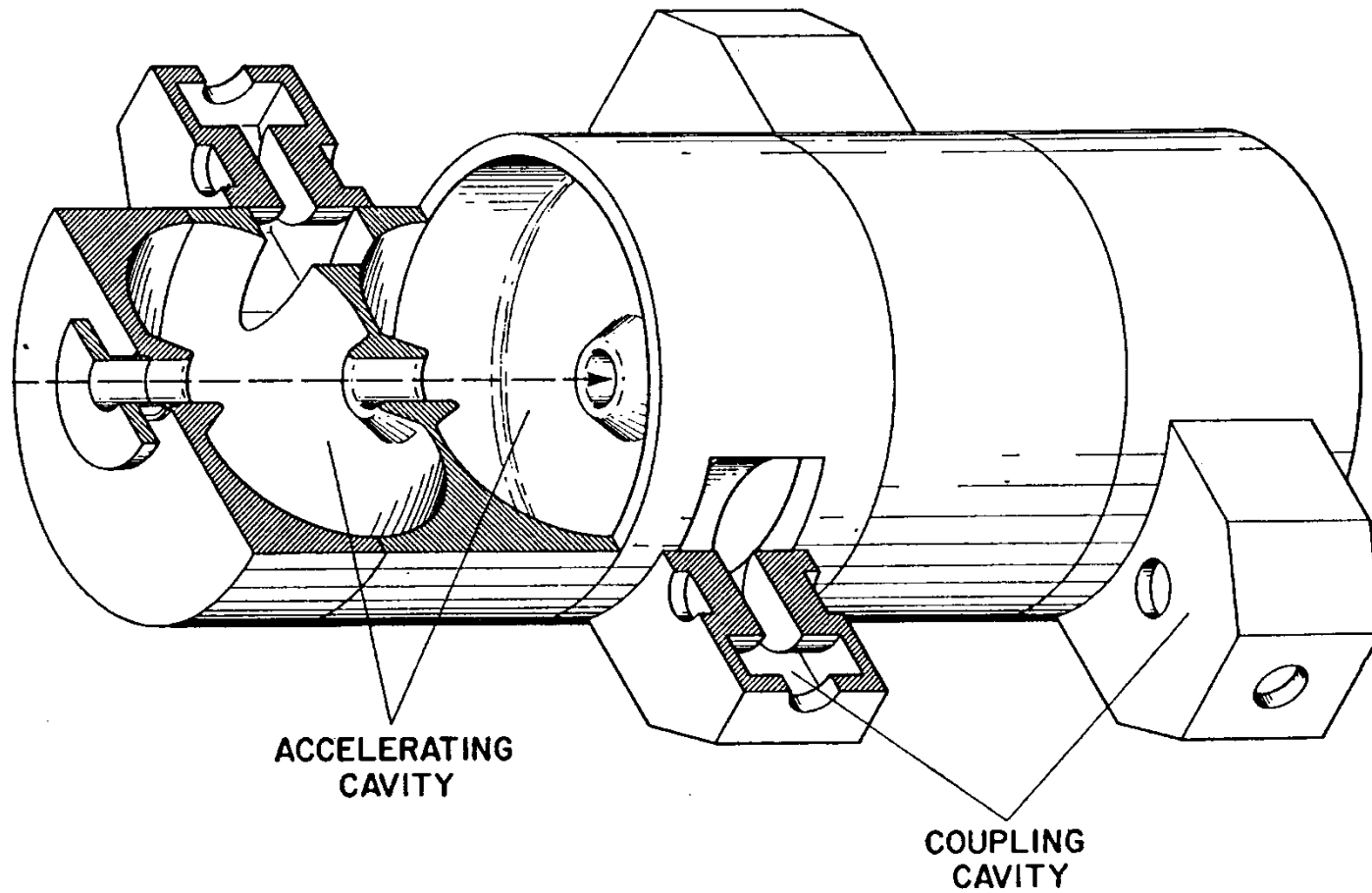

The Side Coupled Linac

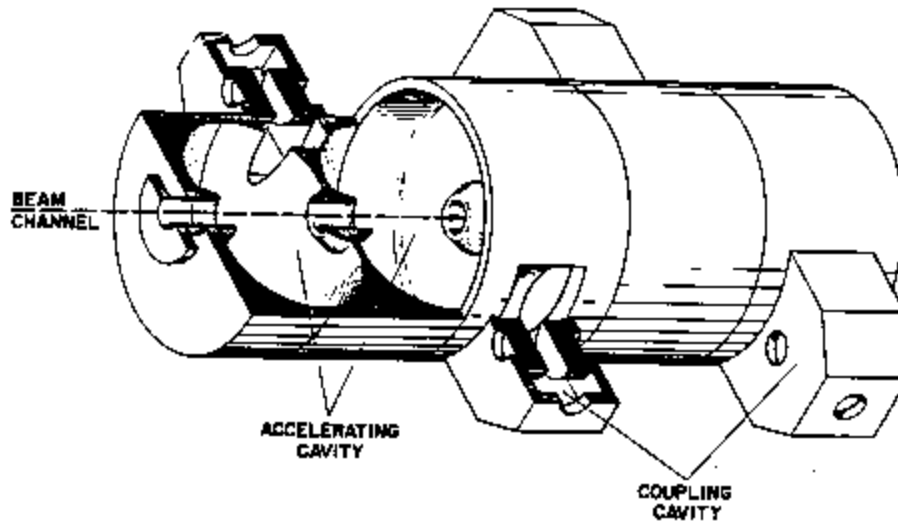

multi-cell Standing Wave
structure in **$\pi/2$ mode**
frequency 800 - 3000 MHz
for protons ($\beta=0.5 - 1$)

Rationale: high beta \Rightarrow cells are longer \Rightarrow advantage for high frequencies

- at high f , high power (> 1 MW) klystrons available \Rightarrow long chains (many cells)
- long chains \Rightarrow high sensitivity to perturbations \Rightarrow operation in $\pi/2$ mode

Side Coupled Structure:

- from the wave point of view, $\pi/2$ mode
- from the beam point of view, π mode

Side Coupled Linac

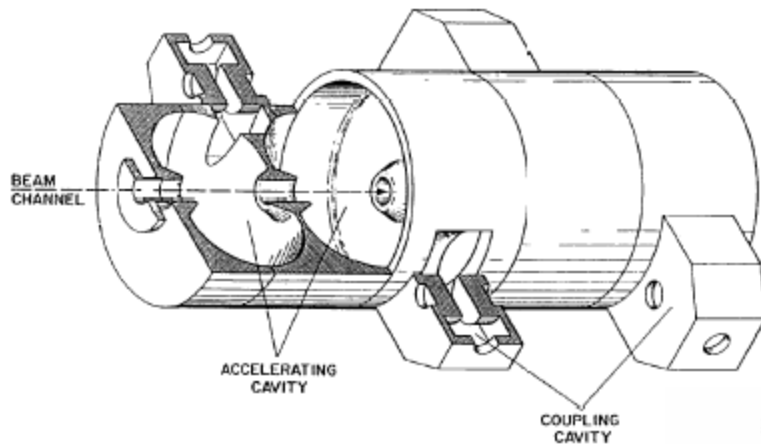

Chain of cells, coupled via slots and off-axis coupling cells. Invented at Los Alamos in the 60's. Operates in the $\pi/2$ mode (stability).

CERN SCL design:
Each klystron feeds 5 tanks of 11 accelerating cells each, connected by 3-cell bridge couplers. Quadrupoles are placed between tanks.

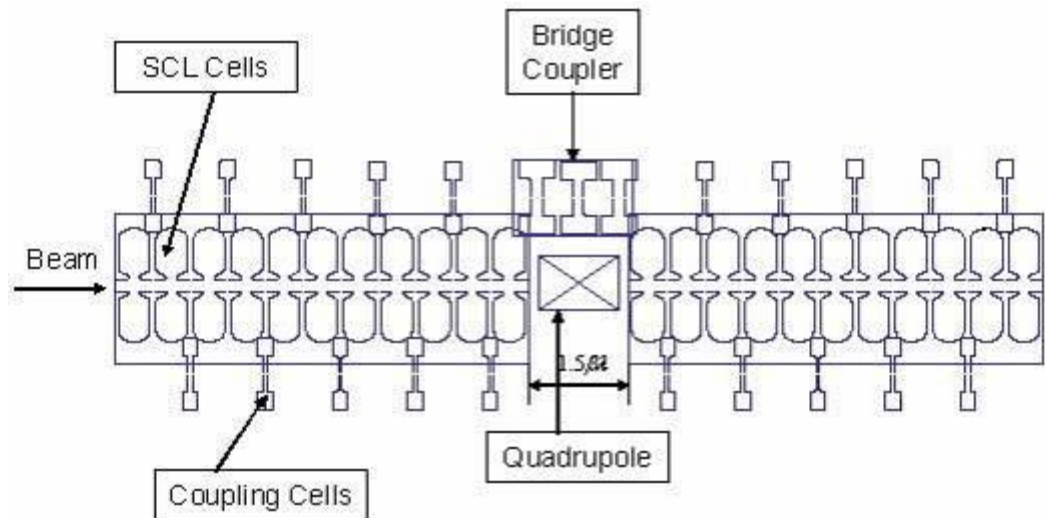

Room Temperature SW structure: The LEP1 cavity

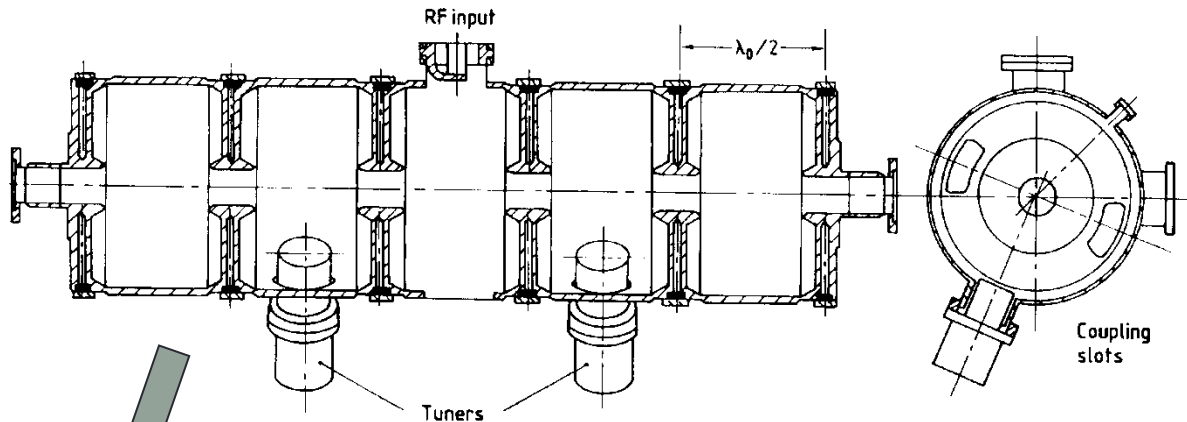

5-cell Standing Wave structure in **π mode** frequency 352 MHz for electrons ($\beta=1$)

To increase shunt impedance :

1. “noses” concentrate E-field in “gaps”
2. curved walls reduce the path for RF currents

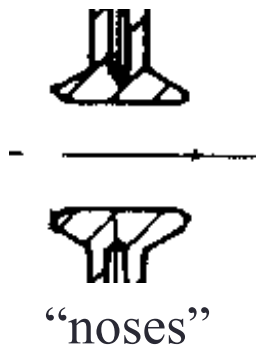

BUT: to close the hole between cells would “flatten” the dispersion curve \Rightarrow introduce coupling slots to provide magnetic coupling

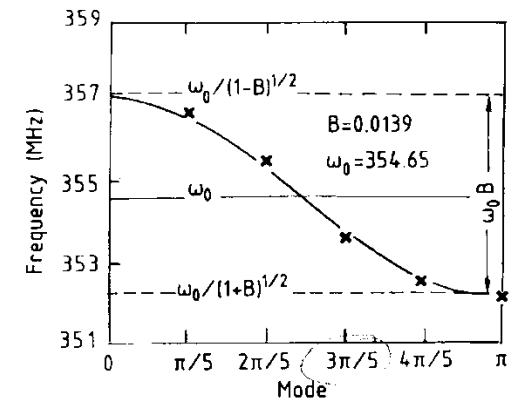

overview

	Ideal range of beta	frequency	Particles
RFQ	Low!!! - 0.05	40-400 MHz	Ions / protons
IH	0.02 to 0.08	40-100 MHz	Ions and also protons
DTL	0.04-0.5	100-400 MHz	Ions / protons
SCL	Ideal Beta=1 But as low as beta 0.5	800 - 3000 MHz	protons / electrons



take with
CAUTION!

352 MHz cavity for 3 MeV protons

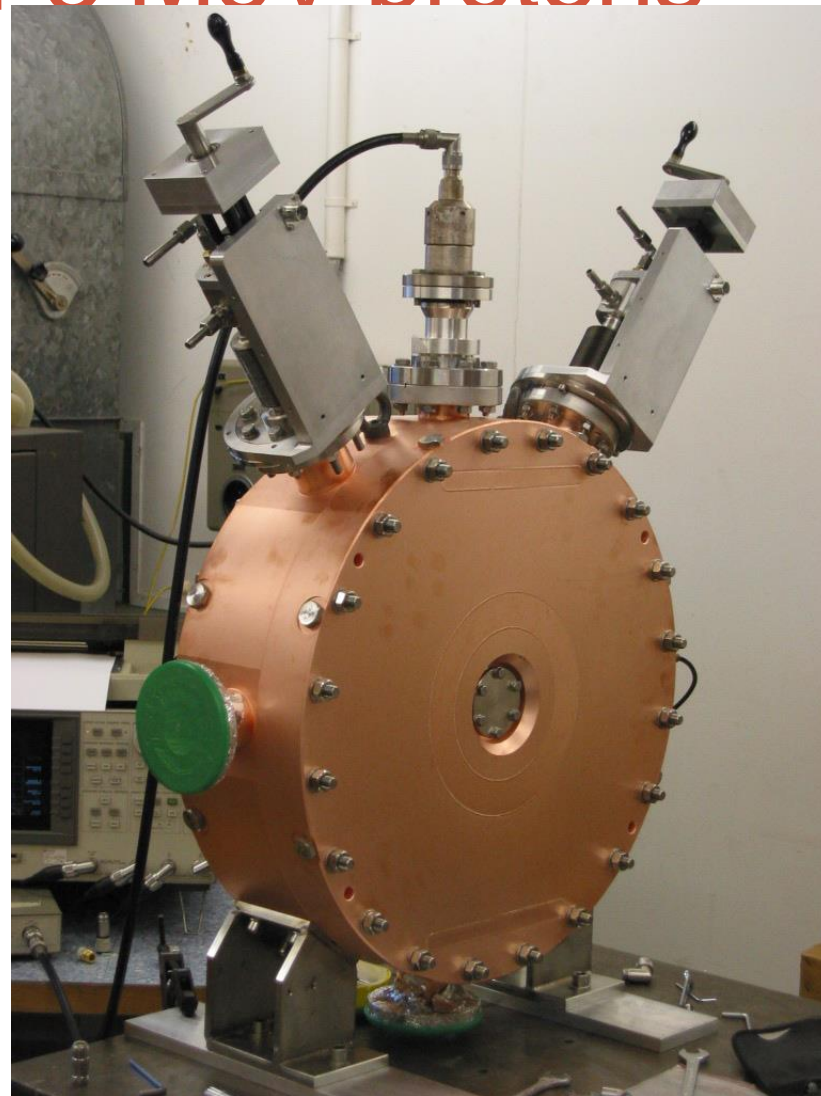
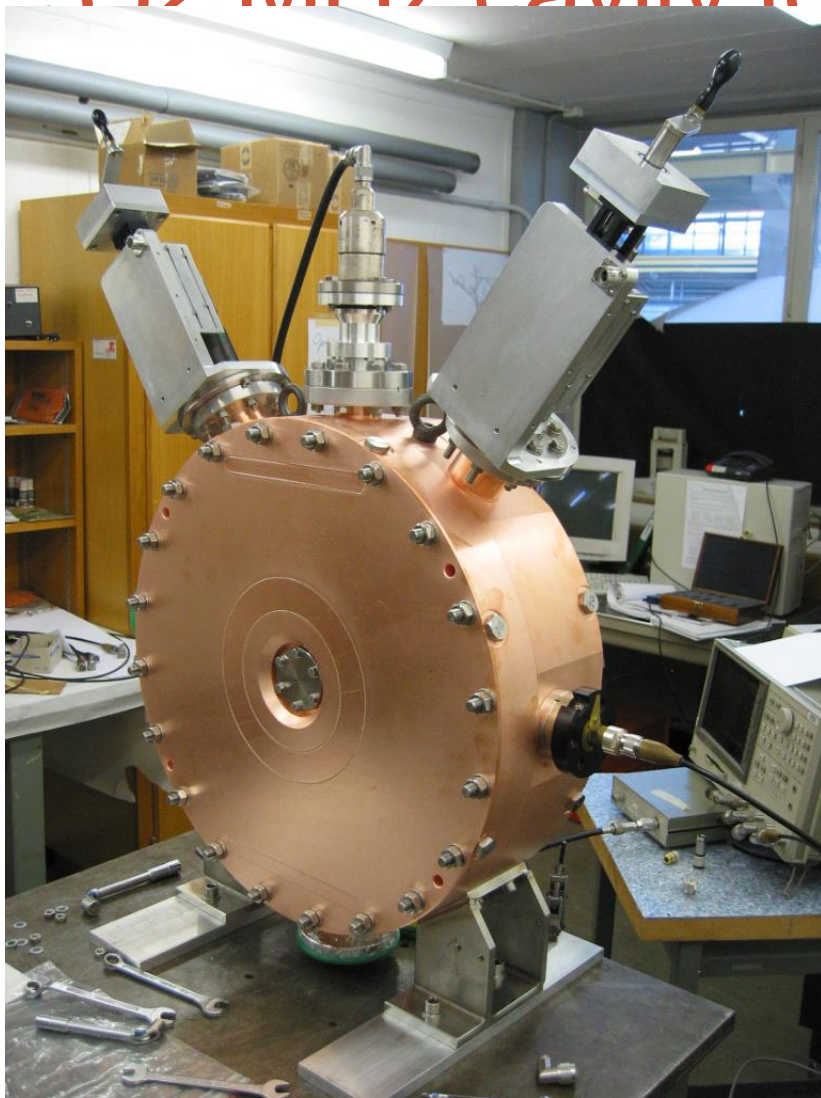

88 MHz cavity for muons

2 MW
amplifier

Nose
Cone
(closed gap)

88 MHz
cavity

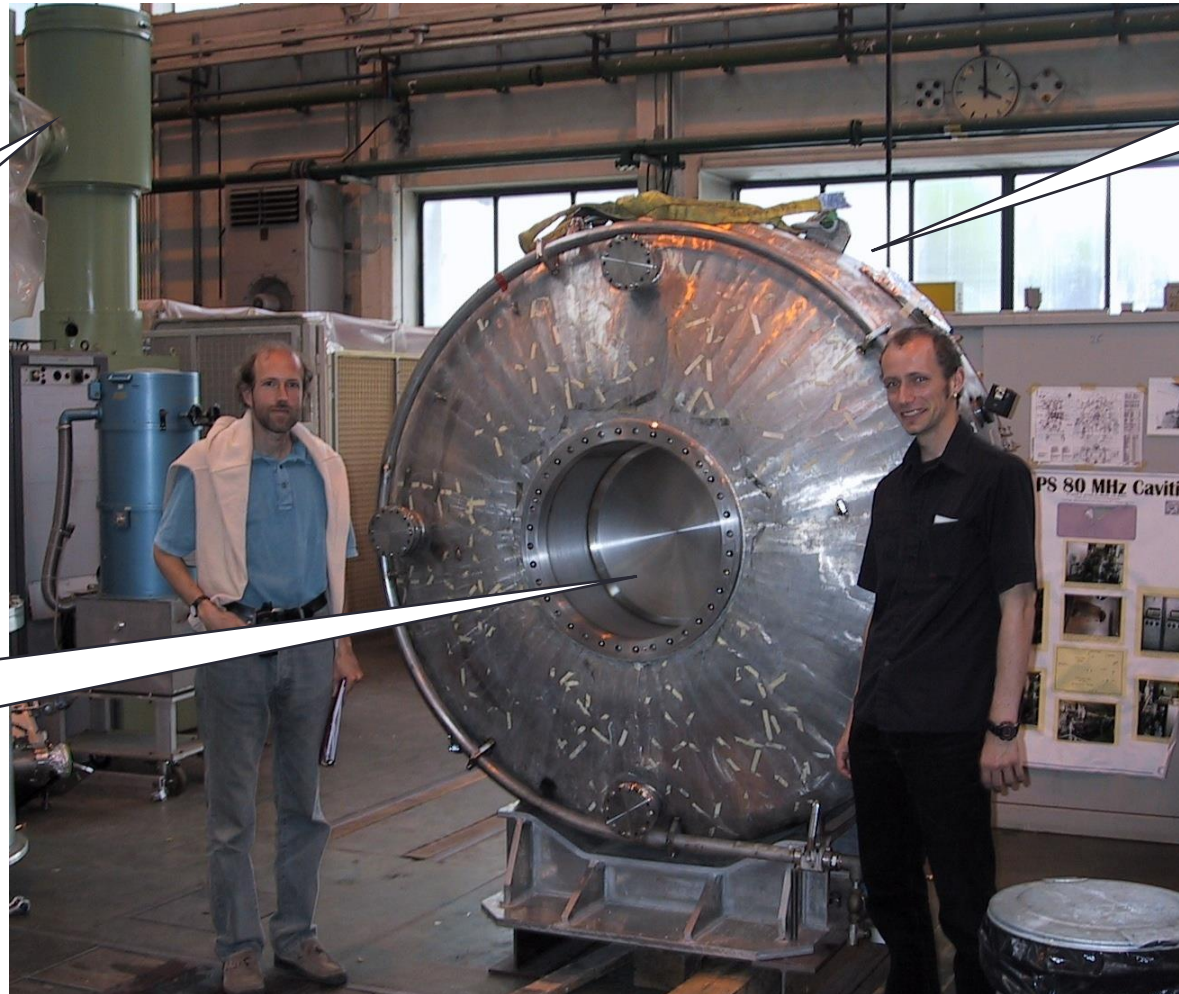

Answer 1 : Rate of change of energy

$$\frac{d\vec{p}}{dt} = q \cdot \left(\vec{E} + \frac{d\vec{x}}{dt} \times \vec{B} \right) \quad \begin{array}{l} \vec{p} = \text{momentum} \\ W = \text{energy} \end{array}$$

$$\frac{dW}{dt} = \frac{d\vec{x}}{dt} \cdot \frac{d\vec{p}}{dt} = q \cdot \frac{d\vec{x}}{dt} \cdot \left(\vec{E} + \frac{d\vec{x}}{dt} \times \vec{B} \right)$$

Energy change via the electric field