

New Design Approach for High Intensity Superconducting Linacs

-

The New ESS Linac Design

Dave McGinnis
Accelerator Division

www.europeanspallationsource.se

10 November 2015

ESS is In Construction!!!

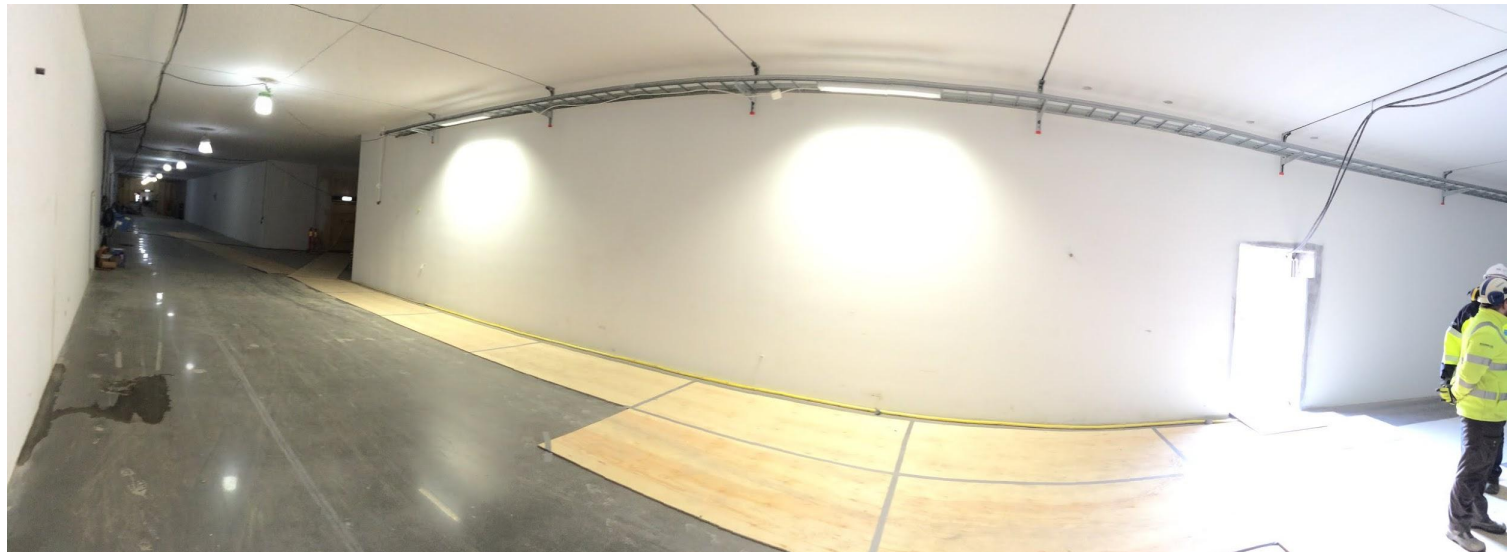

The European Spallation Source (ESS)



- ESS is a neutron spallation source that will be built by a collaboration of 17 European countries.
- ESS is located in southern Sweden adjacent to MAX-IV (A 4th generation light source)

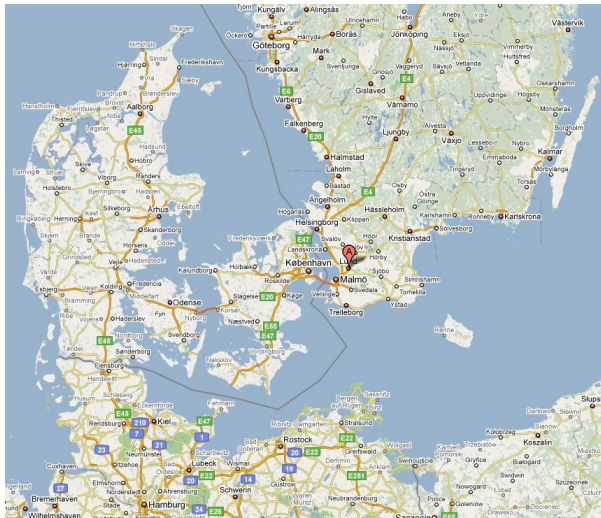

The ESS Linac



- The European Spallation Source (ESS) will house the most powerful proton linac ever built.
 - Average beam power of 5 MW.
 - Peak beam power of 125 MW
 - Acceleration to 2 GeV
 - Peak proton beam current of 62.5 mA
 - Pulse length of 2.86 ms at a rate of 14 Hz (4% duty factor)
- 97% of the acceleration is provided by superconducting cavities.
- The linac will require over 150 individual high power RF sources
 - with 80% of the RF power sources requiring over 1.1 MW of peak RF power
 - We expect to spend over 200 M€ on the RF system alone

ESS Schedule

- Full funding and ground-break in Fall 2014
- 1.25 MW of proton beam power by 2019
- 5 MW of proton beam power by 2022

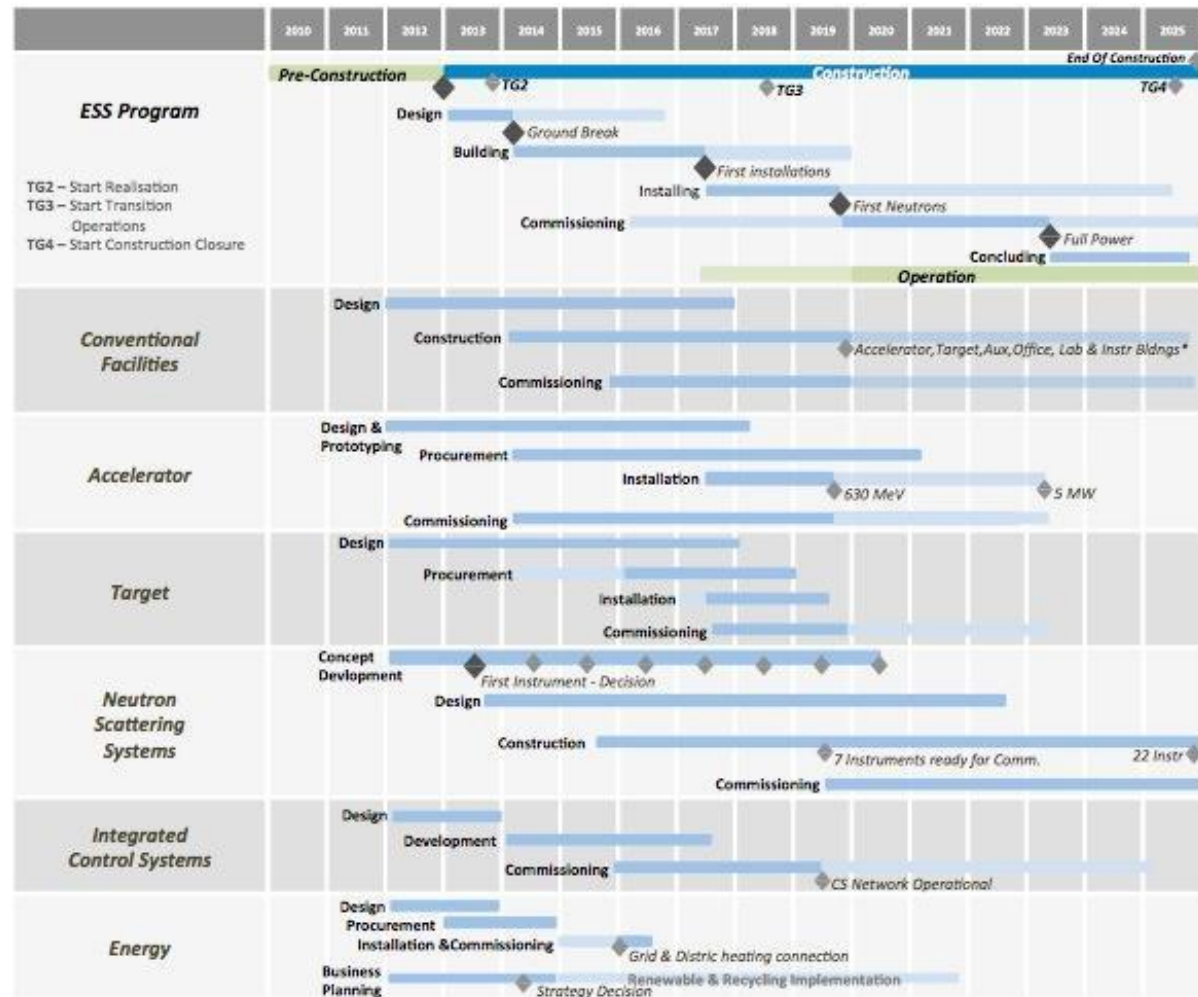

ESS Cost

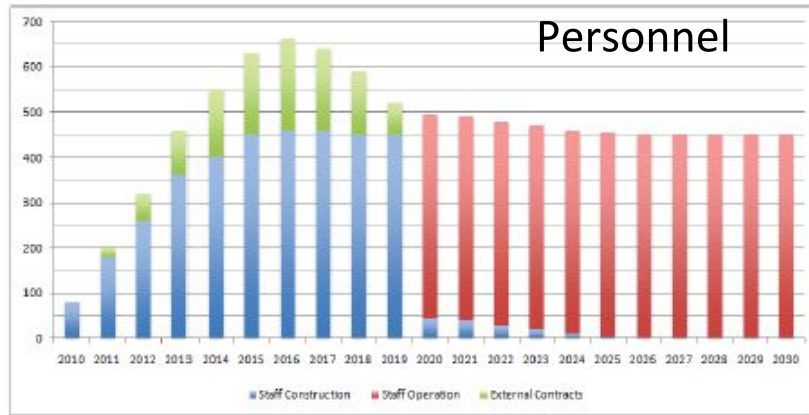

Investment: 1478 M€ / ~10y
 Operations: 89 M€ / y
 Decommissioning. : 346 M€
 (Prices per 2008-01-01)

- Total cost: 1.86 G€
- Accelerator cost: 515 M € (excluding civil construction)

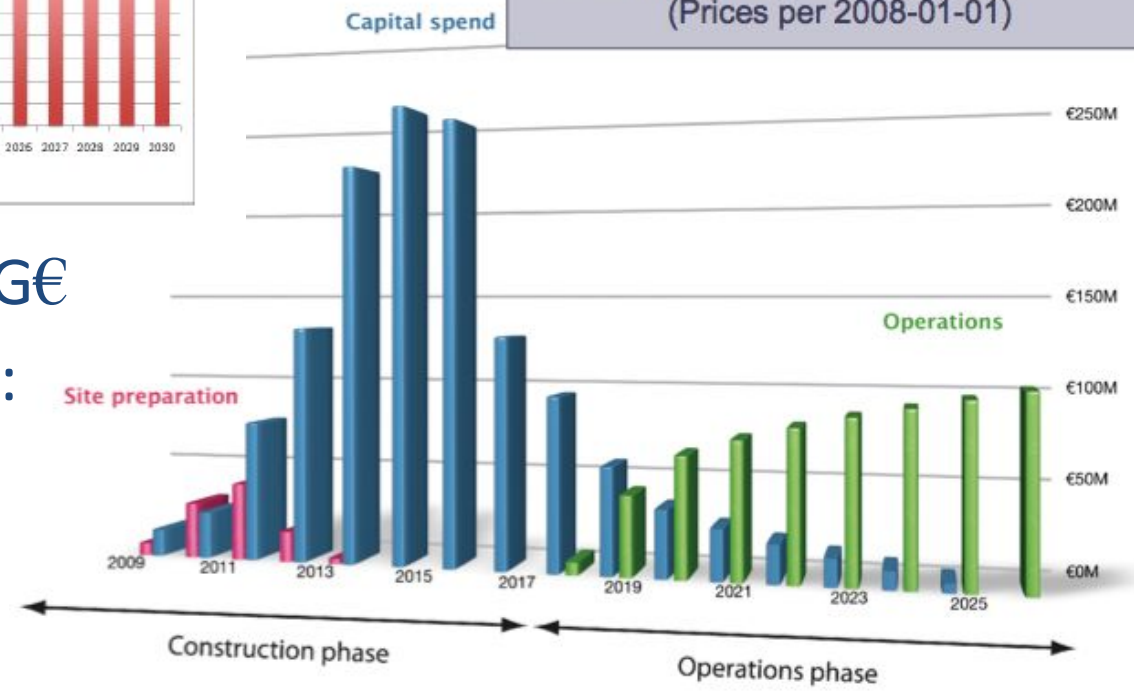

Investment

ESS Funding Model

Sweden, Denmark and Norway
covers 50% of cost



The remaining ESS members
states covers the rest!



with in-kind and cash contributions.

Collaboration

- The cost of the next generation of high intensity accelerators has become so large that no single institution can solely afford to fund the construction of the project.
- To fund these large projects, institutions have embarked on forming ambitious collaboration structures with other laboratories.
 - For example, 60% of the European Spallation Source linac will be funded with in-kind contributions.
- To induce other laboratories to join the collaboration
 - compromises must be made in the accelerator technical design
 - to offer interesting and challenging projects to partner institutions.
- The accelerator system designer must then
 - try to balance the cost and technical risks
 - while also satisfying the interests and external goals of the partner laboratories

ESS Linac Evolution

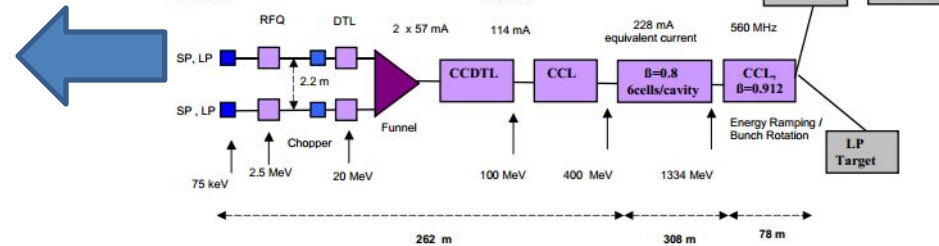
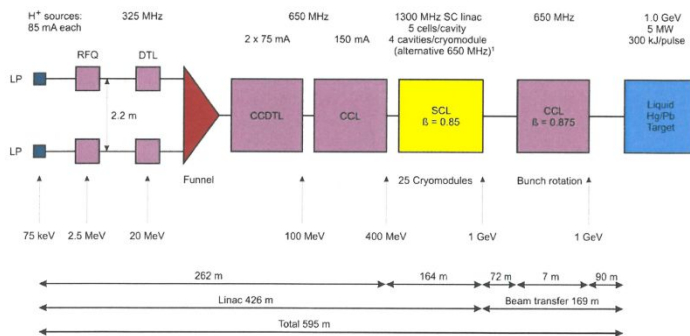
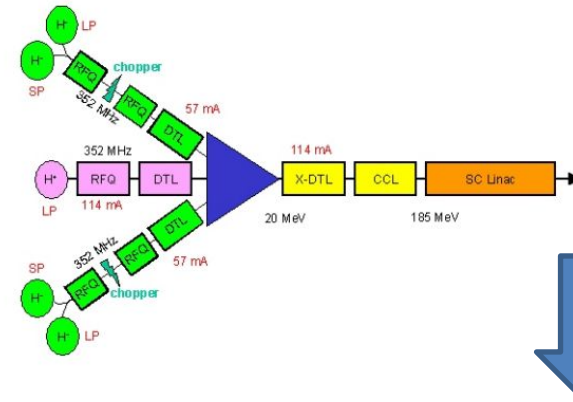
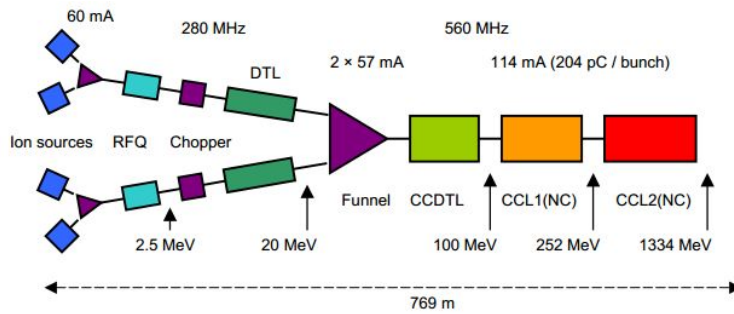

FDSL_2012_10_02

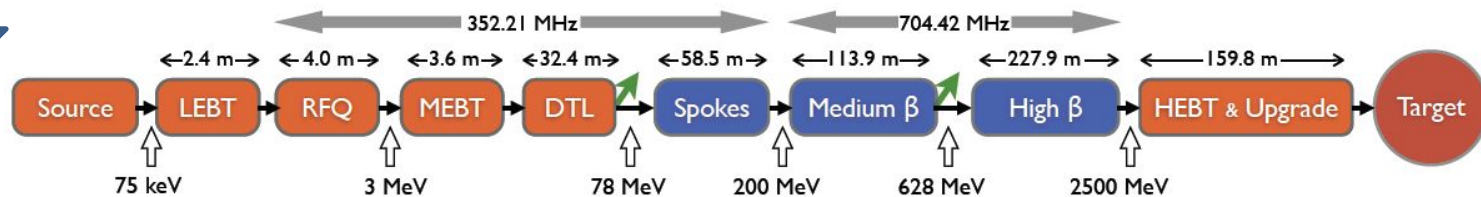

Cost Targets

- Although the 2008 design with 150 mA of beam current has higher technical risk, it **has an inherently lower construction cost** than the October 2012 baseline.
 - Large fraction of the 2008 linac consists of normal conducting structures which are significantly less expensive to build than superconducting structures
 - Lower energy (but higher beam current) requires a significantly shorter linac with less accelerating structures
- However the **current cost targets are based on the 2008 design** even though the October 2012 design:
 - Has many more superconducting structures
 - But provides less technical risk
- The only way to close the gap between the cost estimate and cost target is
 - to **modify the October 2012 baseline by adding technical risk**
 - or increasing the cost target

Cost Drivers

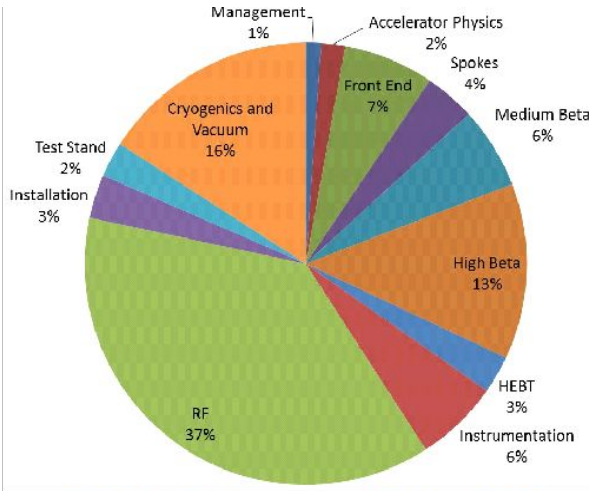

ESS Cost Distribution as of October 2012

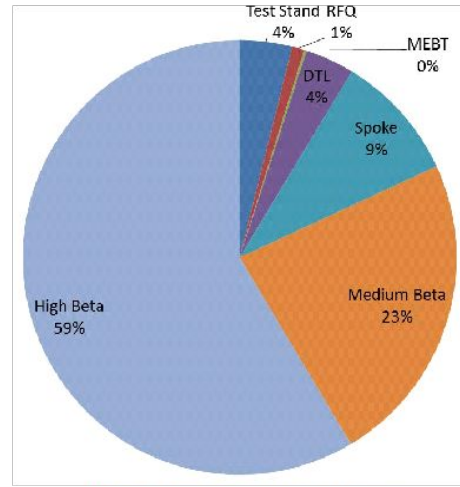

RF System Cost Distribution

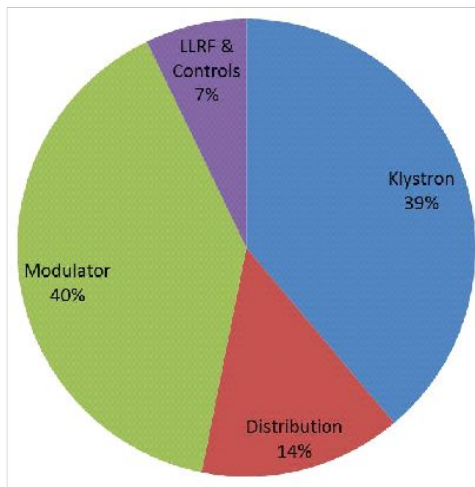

Cost breakdown for 704 MHz Elliptical RF systems

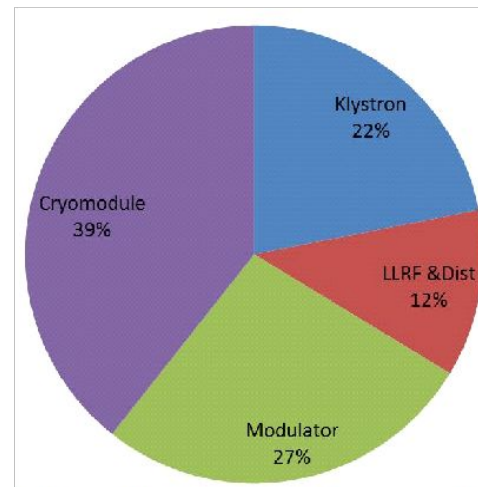

Cost breakdown for high beta cryomodule system.

- Elliptical cryomodules occupy 19% of the cost
 - There are 45 elliptical cryomodules
- The cryogenic plant absorbs 14% of the total cost.
- RF systems comprise 37% of the cost.
 - The RF costs are distributed over five major systems
 - The elliptical section comprises 82% of the RF system cost.
- For the elliptical section,
 - the klystrons and modulators comprise 80% of the RF system cost.
 - 62% of the total cost of the linac.
 - 92% of the acceleration energy

The Long Pulse Concept

- Advantage - No compressor ring required
 - No space charge tune shift so peak beam current can be supplied at almost any energy
 - Relaxed constraints on beam emittance
 - This is especially true if the beam expansion system for the target is based on raster scanning of the beam on the target.
 - No H- and associated intra-beam stripping losses
 - Permits the implementation of target raster scanning
- Disadvantage - Experiment requirements “imprint” Linac pulse structure
 - Duty factor is large for a copper linac
 - Duty factor is small for a superconducting linac

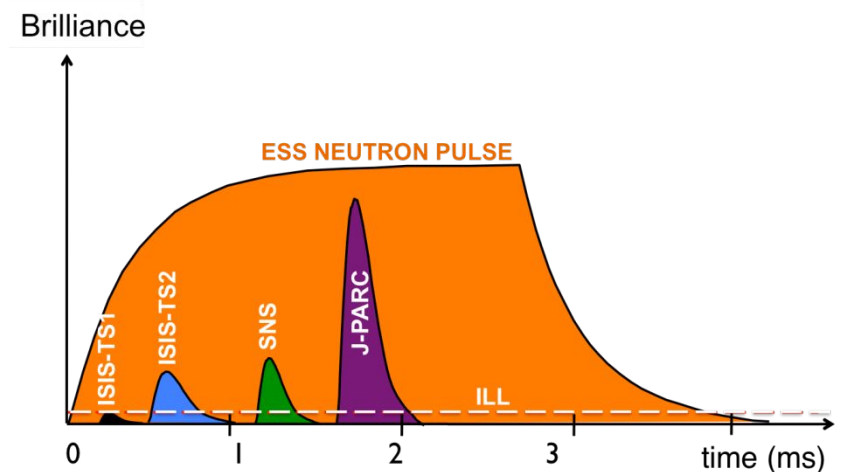

Cost Reduction Strategy

Keep constant $\longrightarrow \langle P_b \rangle = P_{bpk} D = P_{bpk} f_r \tau_p$

$$P_{bpk} = I_b \left(E_{pk} \sum_{n=1}^N \left(M_{cell} \frac{E_{acc} T \beta_g \lambda}{E_{pk}} \frac{\cos(\phi_s)}{2} \right)_n + \frac{\mathcal{E}_{FE}}{q} \right)$$

Reduce

- **The cost of the elliptical cryomodules and associated RF systems are the largest cost driver in the ESS Linac**
- Reducing the number of superconducting cavities will have the largest impact on cost and design contingency
 - each cavity that is removed from the design not only removes the cost of the cavity
 - but also removes the need (and cost) for the RF power sources that feed the cavity.
- Therefore, the design contingency strategy will hold the average beam power constant while looking for avenues to minimize the number of superconducting cavities.

Cost Reduction Strategies

Keep constant $\longrightarrow \langle P \rangle = P_{pk} D = P_{pk} f_r \tau_p$

$$P_{pk} = I_b \left(E_{pk} \sum_{n=1}^N \left(M_{cell} \frac{E_{acc} T \beta_g \lambda}{E_{pk} 2} \right)_n + \frac{\mathcal{E}_{FE}}{q} \right)$$

← Reduce

- Increase

- duty factor, D
- peak surface field, E_{pk}
- peak beam current, I_b
- average value of $E_{acc} T$ sum by adjusting the power profile
- ratio of $E_{acc} T / E_{pk}$ by appropriate choice of β_g
- energy of the front end linac, \mathcal{E}_{FE}

RF Cost Models

Modulator Cost Model

$$C(P) = C_{P_o} \left(R_{cc} \frac{P}{P_o} + R_{cb} \frac{P}{P_o} + R_{ss} \left(\frac{P}{P_o} \right)^{\frac{1}{3}} + R_{xt} \left(\frac{P}{P_o} \right)^{\frac{2}{3}} + R_{cab} + R_{at} \right)$$

Modulator Part	Symbol	Cost (%)	Power Factor
Capacitor Charger	R_{cc}	30	1
Capacitor Banks	R_{cb}	5	1
Solid State Switch	R_{ss}	15	0.33
Transformers	R_{xt}	15	0.67
Cabinets & Controls	R_{cab}	10	0
Assembly & testing	R_{at}	25	0

Klystron Cost Model

$$C(P) = C_{P_o} \left(0.87 + 0.13 \frac{P}{P_o} \right)$$

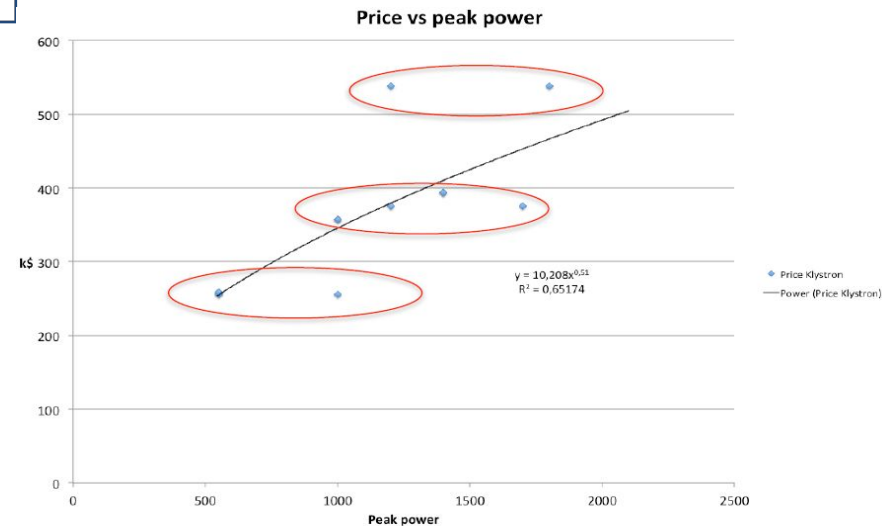

- For any given strategy, as the number of cryomodules is reduced, the remaining cryomodules require more RF power to compensate.
- Simple models have been developed to predict the increased cost of more RF power

Cryogenic Costs

- The average beam power is to be kept constant,
 - the total dynamic heat load of the cryogenic system will be constant
 - if the ratio of E_{pk} to I_b is kept constant.
 - In addition, reducing the number of cryomodules will decrease the total static heat load,
 - A conservative approach would be to not to take credit for the reduction in the static heat load.
 - For a constant beam power, it will be assumed that the cost cryogenic cooling plant will be independent of the number of cryomodules
- As the maximum peak surface field is increased,
 - the dynamic heat load on a given cryomodule will increase
 - the cryogenic cooling of the cryomodule will have to be increased.
 - However at the design duty factor of 4%, the dynamic heat load of a cryomodule is about two thirds the total heat load.
 - This ratio will temper the increased the cost of additional cooling for an individual cryomodule.

$$P_{dn} = \frac{\left(E_{pk} \frac{E_{acc} T}{E_{pk}} M_{cell} \frac{\beta_g \lambda}{2} \right)^2}{\frac{R}{Q_{acc}} Q_0} f_r \tau_p$$

$$P_{dn} = \frac{E_{pk} \frac{E_{acc} T}{E_{pk}} M_{cell} \frac{\beta_g \lambda}{2}}{I_b \cos(\phi_s) \frac{R}{Q_{acc}} Q_0} (P_{bpk} D)_n$$

$$P_d \propto \frac{E_{pk}}{I_b} \langle P_b \rangle$$

Increasing The Duty Factor

- The choice of a superconducting linac becomes obvious as the duty factor increases.
- From an accelerator design point of view, increasing the duty factor has the least impact on the configuration of the accelerator.
- As the duty factor is increased
 - by either increasing the pulse length or the repetition rate,
 - the final energy of the linac can be decreased and still provide the same average beam power.
- However, increasing the duty factor will reduce the peak neutron flux

Increasing the Peak Surface Field

- The peak surface field in the 704 MHz elliptical superconducting cavities is limited to 40 MV/meter in the 2012 design.
- If the limit on the maximum surface field was
 - increased by 10% to a value of 44 MV meter,
 - three high beta cryomodules could be removed.
- 10% more RF power would be required by the remaining RF sources. The cost of the remaining
 - modulators will increase by 5%
 - klystrons will increase by 1.3%.
- However 81% of the cost of the removed cryomodules and RF systems could be recovered
- Providing a cost reduction of almost 3% for the entire linac.

Increasing the Beam Current

- There are a number of “soft” limits on the peak beam current which are difficult to quantify
 - Space charge forces
 - Halo, etc.
- A hard limit on beam current is the peak power in the RF couplers for the superconducting cavities.
 - The current coupler design has been tested to 1200kW
 - Due to the lack of test information, it is unknown if the couplers can be pushed harder.
 - As a result, 1200W in the couplers will be taken as a hard limit

Increasing the Beam Current

- For a peak surface field of 44 MV/ meter, the beam current can be increased to 63.5 mA and keep the coupler power below 1200kW.
- If the beam current was increased to 55 mA and the peak surface field is increased to 44 MV/m, six high beta cryomodules could be removed.
 - 21% more RF power would be required by the remaining RF sources. The cost of the remaining
 - modulators will increase by 10%
 - klystrons will increase by 2.7%.
- However 81% of the cost of the removed cryomodules and RF systems could be recovered
- Providing a cost reduction of almost 5.8% for the entire linac.

Adjusting the Voltage Profile

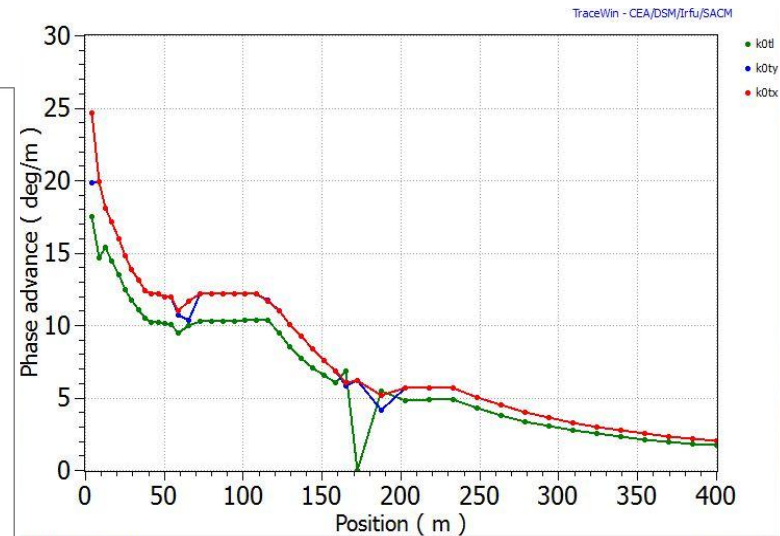
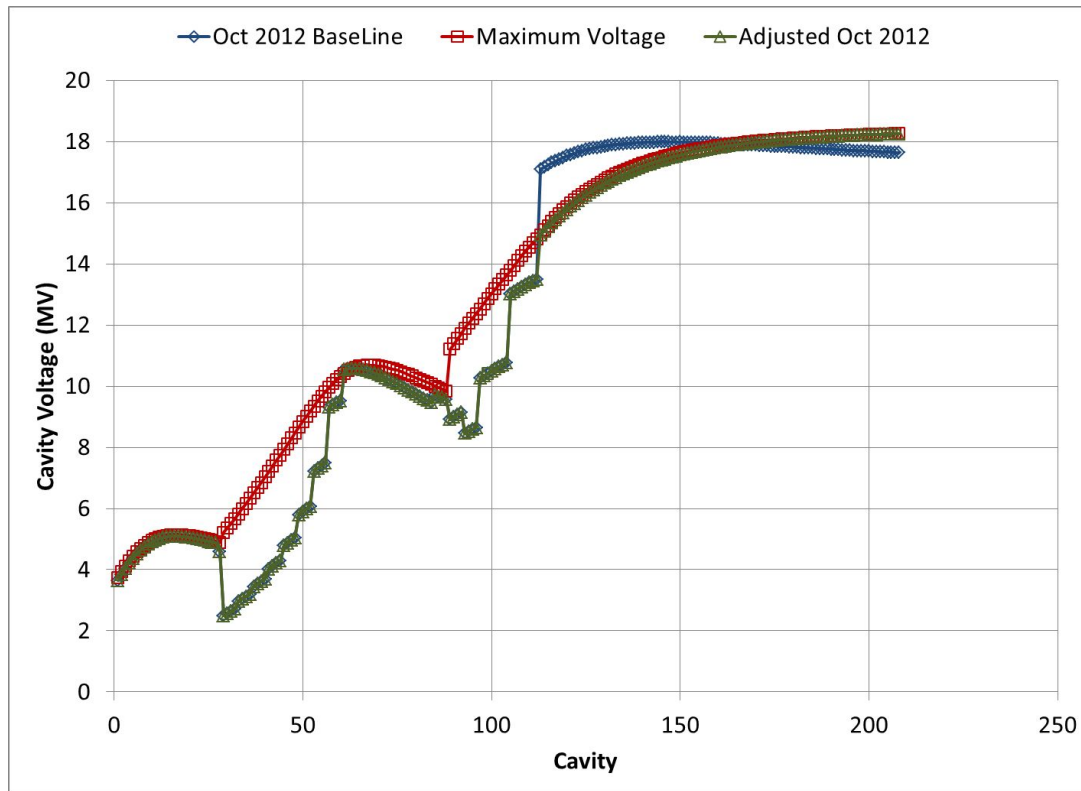

- The October 2012 voltage profile is not maximum
 - so as to have a smooth phase advance
 - Low emittance dilution

Alternative Voltage Profiles

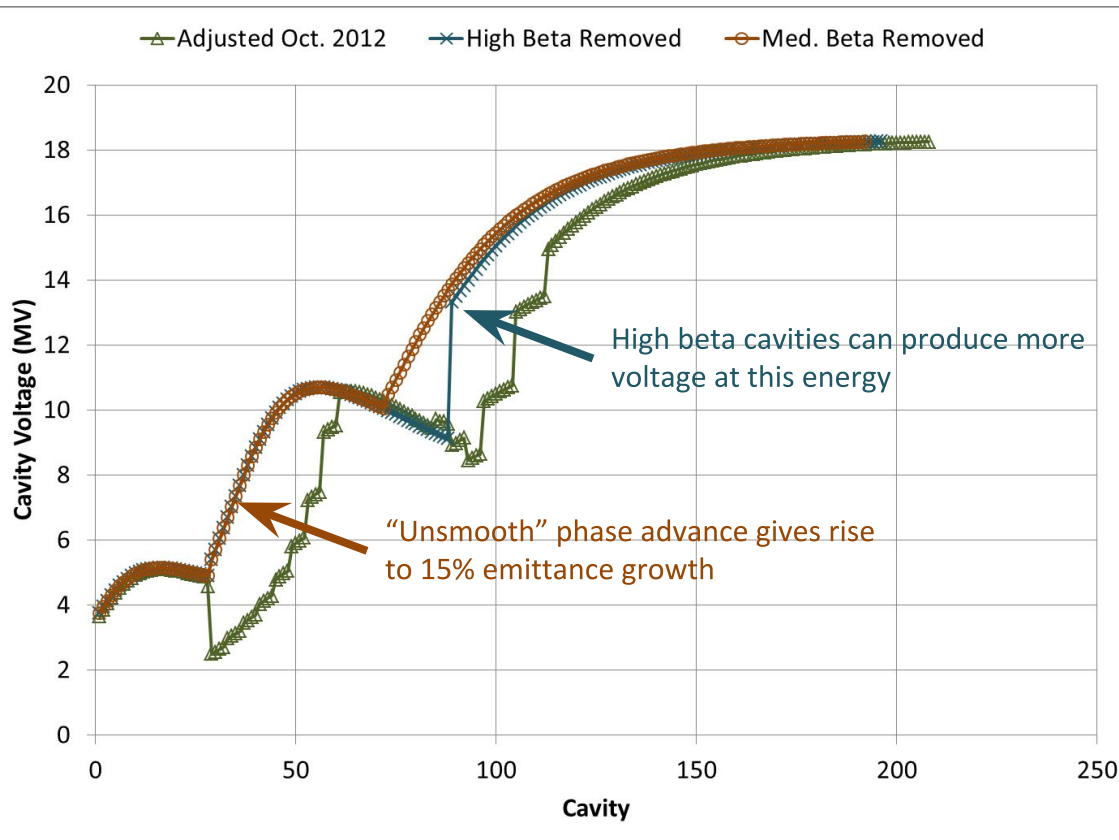

- **October 2012 profile**
 - 60 medium beta cavities in 15 C.M.
 - Smooth phase advance region
 - 120 high beta cavities in 30 C.M.
 - Voltage matching region
- **“Med. Beta Removed” profile**
 - 48 medium beta cavities in 12 cryomodules
 - “Unsmooth” phase advance gives rise to 15% emittance growth
 - 120 high beta cavities in 30 C.M.
 - No matching region required

Choice of Geometrical Beta

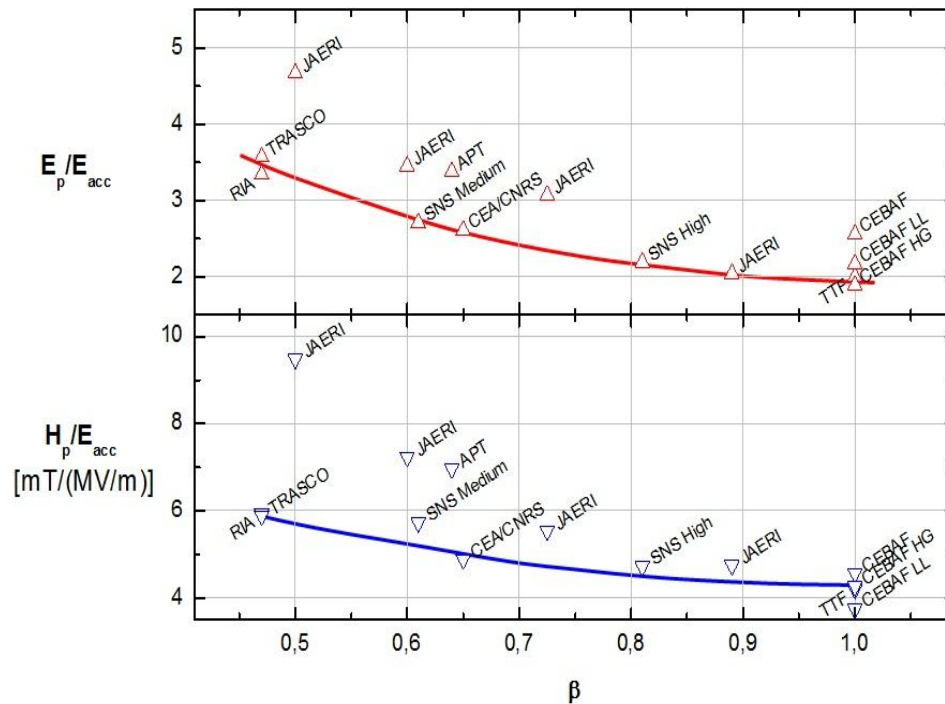

- At an energy of 2500 MeV, the beam beta is 0.96.
- In the October 2012 baseline,
 - the high beta cavities have a geometrical beta of 0.92
 - which have an optimum beta of 0.985.
- There is experimental evidence that for a given peak surface field, higher accelerating gradient that can be achieved for higher geometrical beta cavities.
 - For example, the 0.86 cavity designed for ESS by CEA
 - has an accelerating gradient of 17.9 MV/m
 - for a peak surface field of 40 MV/meter.
 - A 0.92 cavity
 - could have an accelerating gradient of 18.7 MV/meter
 - for a surface field of 40 MV/meter.

Choice of Geometrical Beta

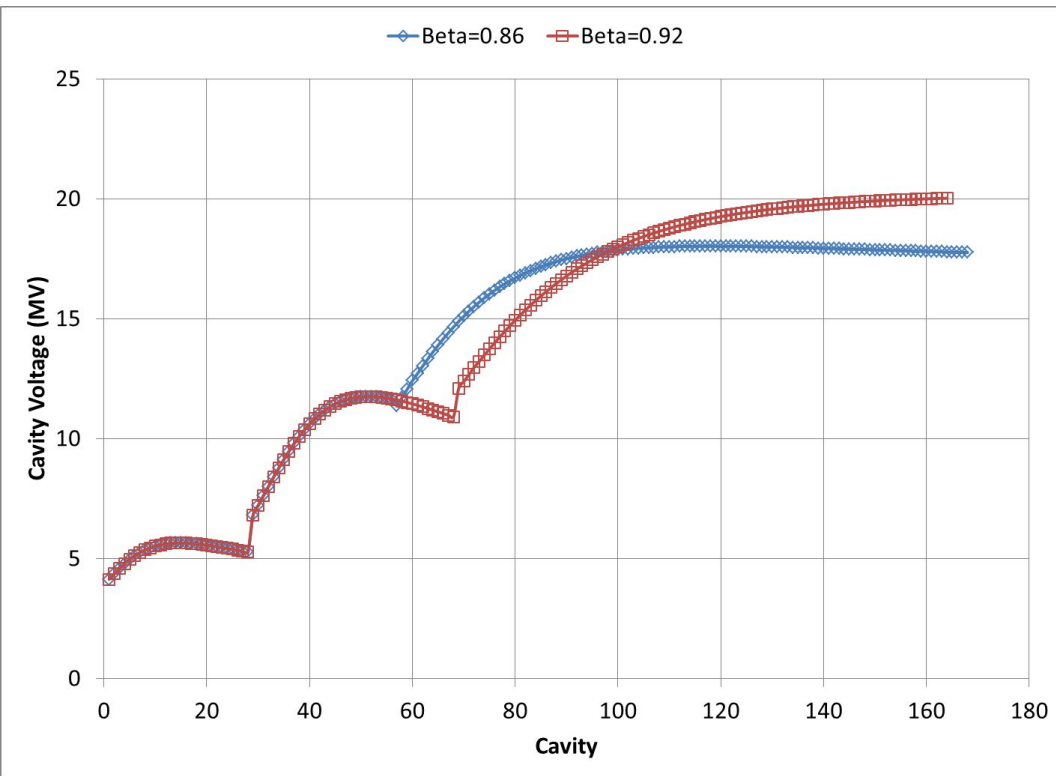

- For a peak surface field of 44MV/meter and a beam current of 55 mA.
 - the required energy of the linac is reduced to 2273 MeV
 - the corresponding beam beta becomes 0.956.
- For the profile with the geometrical beta of 0.92,
 - 40 medium beta cavities (10 cryomodules)
 - 96 high beta cavities (24 cryomodules) reach an energy of 2295 MeV.
- For the profile with the geometrical beta of 0.86,
 - Only 28 medium beta cavities (7 cryomodules) are required.
 - However, 112 high beta cavities (28 cryomodules) are needed to reach an energy of 2333 MeV.
- Thus the higher geometrical beta of 0.92 requires one less cryomodule than the 0.86 cavities to achieve a minimum of 5 MW of beam power

Choice of Geometrical Beta

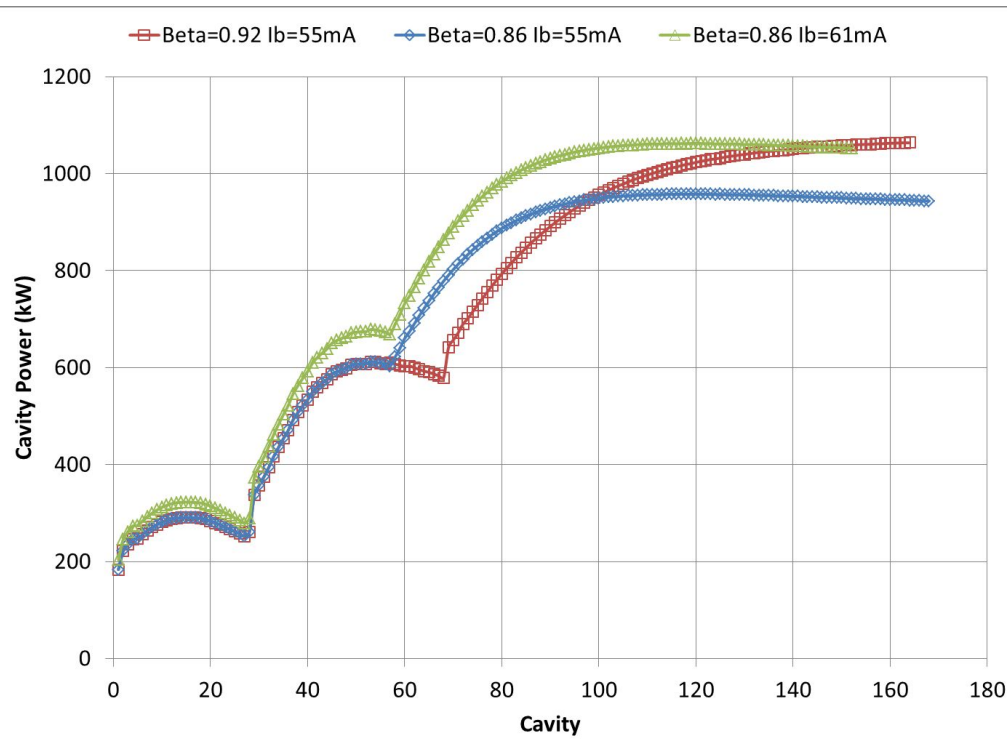

- For a peak surface field of 44MV/meter and a beam current of 55 mA.
 - The 0.92 cavities require 1060 kW of peak RF power
 - compared to 960 kW required for the 0.86 cavities.
- Since the coupler design is independent of geometrical beta,
 - it is possible to run 1060 kW of power into the 0.86 cavities
 - if the beam current is increased to 62 mA
- A beam current of 62 mA requires a final energy of only 2049 MeV for the linac.
 - The number of 0.86 high beta cavities can be reduced to 96 cavities (24 cryomodules).
- For the 0.92 design at 1060kW/coupler
 - **34 elliptical cryomodules are required**
 - 10 medium beta and 24 high beta
- For the 0.86 design at 1060kW/coupler
 - **31 elliptical cryomodules are required**
 - 7 medium beta and 24 high beta

Lattice Cell Length

- For the October 2012 baseline design, the cell length along the linac changes substantially.
 - 4.18 meters in the spokes,
 - 7.12 meters in the medium beta section with one cryomodule per cell
 - 15.19 meters in the high beta section with two cryomodules per cell.
- For a maximized voltage profile, a high beta $\beta_g=0.86$, and an $I_b=62\text{mA}$,
 - over half the medium beta cryomodules are eliminated
 - the beginning of the high beta region is now 520 MeV
- At this energy, the current long high beta cells is too weak at to provide the desired phase advance per cell of 87 degrees with reasonable gradients in the quadrupoles.
- Thus a fourth type of cell with one high beta cryomodule per cell would be needed in this region.

Uniform Lattice Cell Length

- A tunnel design with many different cell lengths is very undesirable with the perspective of considering:
 - design contingency
 - future upgrades.
- In the future, it might be advantageous to interchange
 - spoke cryomodules with medium beta cryomodules.
 - medium beta cryomodules with high beta cryomodules.
- At the added expense of a longer linac, the new baseline has:
 - Spoke cell Length = $0.5 \times$ Medium beta cell length
 - Medium beta cell length = High beta cell length
- A uniform cell length provides the possibility that the medium and high beta cryomodules could be interchangeable and possibly identical.
 - 6 cell medium beta cavities that would be close to the same length of the high beta cavities.
 - This would reduce the prototyping schedule (and cost) significantly because only one type cryomodule prototype would need to be constructed.
 - Also a 6 cell medium beta cryomodule requires one less high beta cryomodule to achieve 5 MW of beam power

6 Cell Medium Beta Cavities

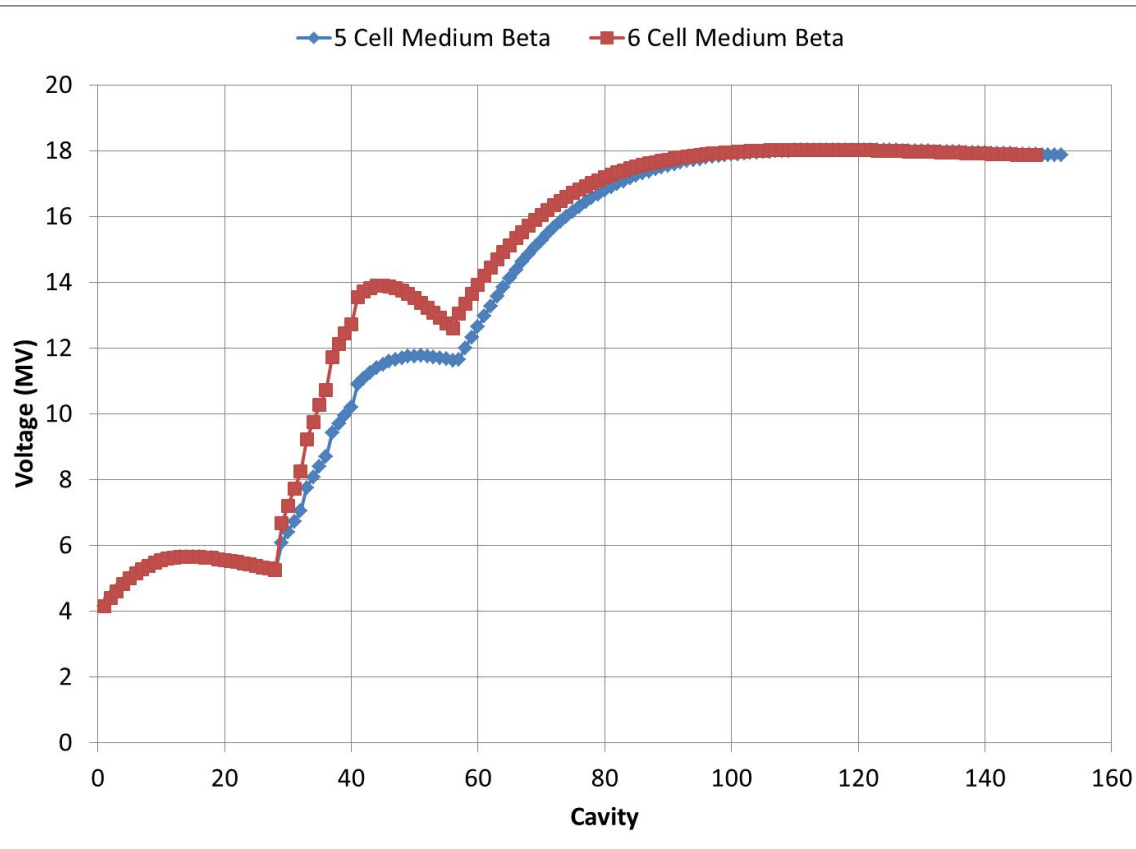

- For a uniform lattice cell length,
 - the current 5 cell medium beta cavities need a drift of 0.2 meters after each cavity
 - Might require a specialized port on the cryomodule to access the tuner package for both species of geometrical beta
- If 6 cell medium beta cavities ($\beta_g = 0.67$) are used,
 - the extra drift is reduced to 0.06 meters
 - One less high beta cryomodule required

New Baseline Layout

Done by a professional: M. Eshraqi

13 × Spoke cryo-modules



9 × Mβ cryo-modules



21 × Hβ cryo-modules



Optimus+

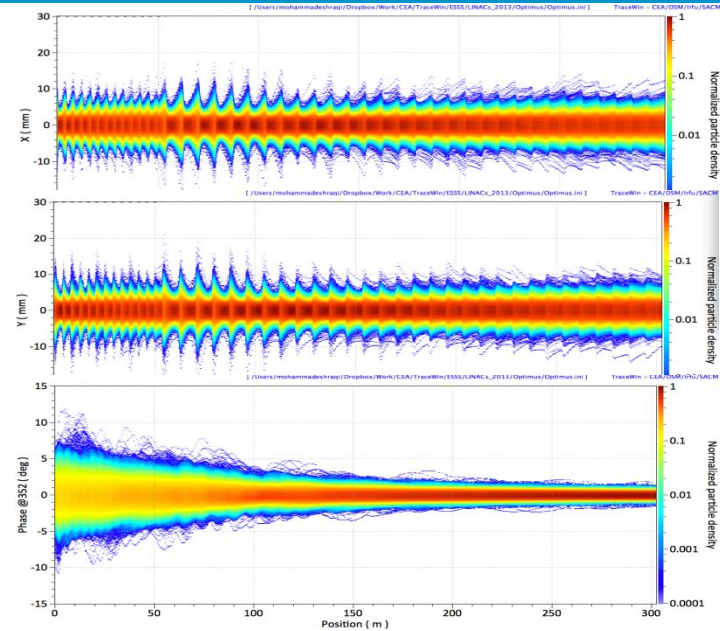
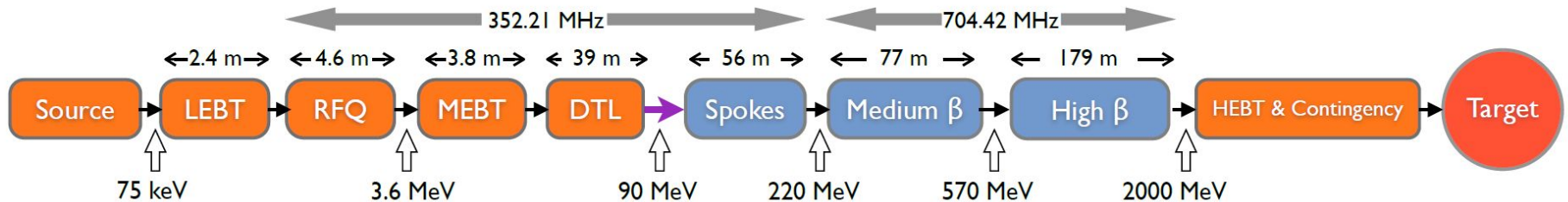

New Baseline Power Profile

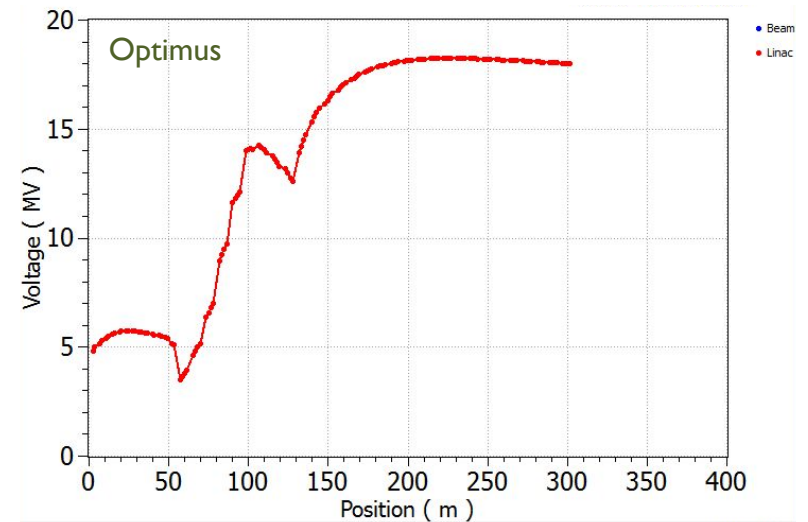
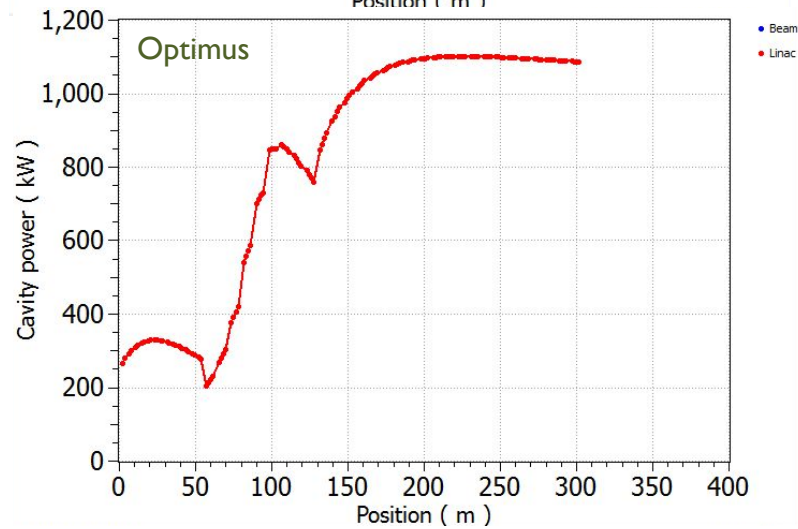
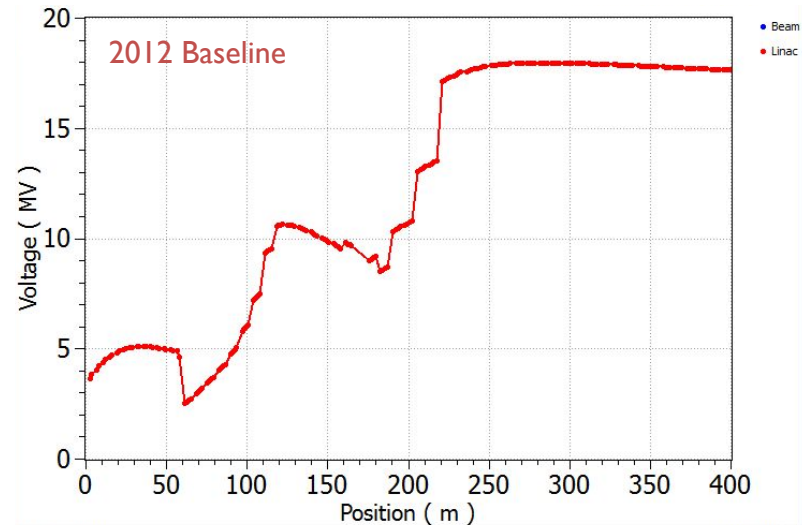
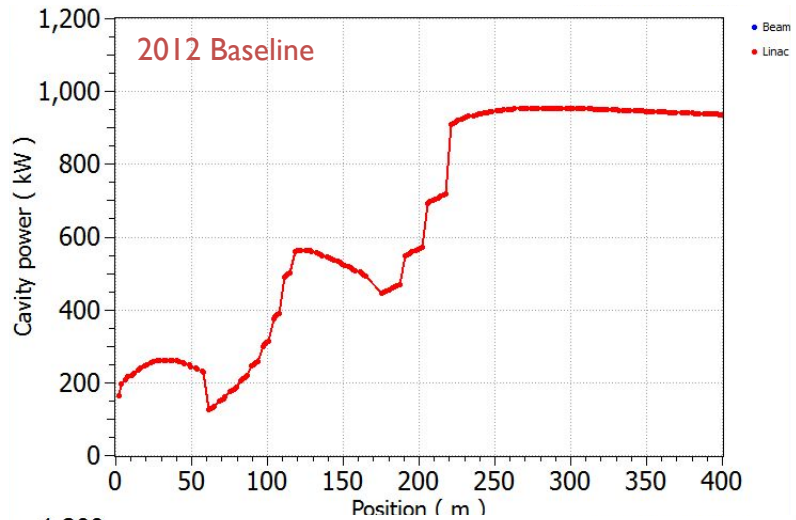

New Baseline Lattice

	Optimus	Unit
$E_{\text{acc Spoke}}$	9	MV/m
V_{Spoke}	5.74 ($L = 3 \beta \lambda / 2$)	MV
$P_{\text{coupler Spoke}}$	330	kW
$N_{\text{Spoke modules}}$	13	—
$E_{\text{acc M}\beta}$	16.79	MV/m
$V_{\text{M}\beta}$	14.36 ($L = 6 \beta' \lambda' / 2$)	MV
$P_{\text{coupler M}\beta}$	860	kW
$N_{\text{M}\beta \text{ modules}}$	9	—
$E_{\text{acc H}\beta}$	19.94	MV/m
$V_{\text{H}\beta}$	18.24 ($L = 5 \beta'' \lambda'' / 2$)	MV
$P_{\text{coupler H}\beta}$	1100	kW
$N_{\text{H}\beta \text{ modules}}$	21	—

New Baseline

- **New Baseline Headline Parameters**
 - 5 MW Linac
 - 2.0 GeV Energy (30 elliptical cryomodules)
 - 62.5 mA beam current
 - 4% duty factor (2.86 mS pulse length, 14 Hz)
 - First beam by 2019 (1.0 MW at 570 MeV)
- **The new baseline was achieved by:**
 - Increasing beam current by 25%
 - Increasing Peak Surface Field by 12%
 - Setting High Beta β_g to 0.86
 - Adopting maximum voltage profile
 - Adopting a uniform lattice cell length in the elliptical section to permit
 - design flexibility
 - schedule flexibility.

Design Risk

- Reduced the number of elliptical cryomodules from 45 to 30
 - Each cryomodule + RF to power the cryomodule costs ~6.5 M€
 - Elimination of 15 cryomodules yields 78 M€ savings (6.5 M€ x 15 x 80% (power factor))
- By accepting large technical risk
 - Power Couplers:
 - Maximum coupler power is 1200 kW
 - Went from 850 kW/coupler to 1100 kW/coupler
 - **Reduced our design margin by 70%**
 - Cavity Peak Surface Field
 - Maximum surface field is 50 MV/meter
 - Went from 40 MV/meter to 45 MV/meter
 - **Reduced our design margin by 50%**

Design Contingency

- ESS uses the Long Pulse concept
 - No compressor ring is required
 - Peak beam current can be supplied at almost any energy
- If we fail to meet our goals on:
 - Beam current
 - Cavity gradient
 - Power coupler power
- The accelerator complex will still function but at a reduced beam power
- We can buy back the beam power in the future by adding high beta cryomodules to the end of the linac
 - As long as the additional space is reserved.
- We proposed to mitigate these risks by reserving the tunnel space for 15 cryomodules (127.5 meters) as “design contingency”.

Conventional Facility Costs

- The approximate costs for conventional facilities are:
 - Tunnel: 22,900 €/m (3270 k€ / m²) including berm, auxiliary costs
 - Gallery: 46,200 €/m (2800 k€ / m²)
- The cost of accelerator equipment is:
 - 6.5 M€ / cryomodule which includes the RF power
 - Average cost of superconducting RF accelerator equipment is:
 - 790,000 €/m
 - 35x more expensive than tunnel cost
 - 11.4x more expensive than total CF cost
 - Average beam power cost for the accelerator equipment in a cryomodule cell is 18kW / M€.
- The cost of the 127 meter contingency space without stubs and gallery is 2.9 M€
 - Equivalent to the cost of accelerator equipment needed to supply 0.052 MW of average beam power (1% of 5 MW)

Summary

- Large accelerator facilities require collaboration to afford the cost and the technical resources
- To induce other laboratories to join the collaboration
 - compromises must be made in the accelerator technical design
 - to offer interesting and challenging projects to partner institutions.
- These compromises may incur additional costs
- The accelerator system designer must then
 - try to balance the cost with technical risks
 - while also satisfying the interests and external goals of the partner laboratories
- Avenues of design contingency must be built into the design to mitigate the risks