

**CAS**

THE CERN ACCELERATOR SCHOOL

CAS 2009, Darmstadt, Germany

# Low Emittance Machines

Lecture 2

Equilibrium Emittance and Storage Ring Lattice Design

---

Andy Wolski

*University of Liverpool and the Cockcroft Institute*



# Lecture 1 summary

---

In Lecture 1, we:

- discussed the effect of synchrotron radiation on the (linear) motion of particles in storage rings;
- derived expressions for the damping times of the vertical, horizontal and longitudinal emittances;
- discussed the effects of quantum excitation, and derive expressions for the equilibrium horizontal and longitudinal beam emittances in an electron storage ring.

# Lecture 1 summary: equilibrium beam sizes

The natural emittance is:

$$\varepsilon_0 = C_q \gamma^2 \frac{I_5}{j_x I_2} \quad C_q = 3.832 \times 10^{-13} \text{ m}$$

The natural energy spread and bunch length are given by:

$$\sigma_\delta^2 = C_q \gamma^2 \frac{I_3}{j_z I_2} \quad \sigma_z = \frac{\alpha_p c}{\omega_s} \sigma_\delta$$

The momentum compaction factor is:

$$\alpha_p = \frac{I_1}{C_0}$$

The synchrotron frequency and synchronous phase are given by:

$$\omega_s^2 = -\frac{eV_{RF}}{E_0} \frac{\omega_{RF}}{T_0} \alpha_p \cos \varphi_s \quad \sin \varphi_s = \frac{U_0}{eV_{RF}}$$

# Lecture 1 summary: synchrotron radiation integrals

The synchrotron radiation integrals are:

$$I_1 = \oint \frac{\eta_x}{\rho} ds$$

$$I_2 = \oint \frac{1}{\rho^2} ds$$

$$I_3 = \oint \frac{1}{|\rho|^3} ds$$

$$I_4 = \oint \frac{\eta_x}{\rho} \left( \frac{1}{\rho^2} + 2k_1 \right) ds \quad k_1 = \frac{e}{P_0} \frac{\partial B_y}{\partial x}$$

$$I_5 = \oint \frac{\mathcal{H}_x}{|\rho|^3} ds \quad \mathcal{H}_x = \gamma_x \eta_x^2 + 2\alpha_x \eta_x \eta_{px} + \beta_x \eta_{px}^2$$

# Lecture 2 objectives: lattices for low-emittance electron storage rings

---

In this lecture, we shall:

- derive expressions for the natural emittance in four types of lattice:
  - FODO
  - DBA (double-bend achromat)
  - multi-bend achromat, including the triple-bend achromat (TBA)
  - TME (theoretical minimum emittance)
- consider how the emittance of an achromat may be reduced by "detuning" from the zero-dispersion conditions;
- (in Appendix A) discuss the use of wigglers to reduce the natural emittance in a storage ring;
- (in Appendix A) derive an expression for the natural emittance in a wiggler-dominated storage ring.

# Calculating the natural emittance in a lattice

In Lecture 1, we showed that the natural emittance is given by:

$$\varepsilon_0 = C_q \gamma^2 \frac{I_5}{j_x I_2}$$

where  $C_q$  is a physical constant,  $\gamma$  is the relativistic factor,  $j_x$  is the horizontal damping partition number, and  $I_5$  and  $I_2$  are synchrotron radiation integrals

$j_x$ ,  $I_5$  and  $I_2$  are all functions of the lattice, and independent of the beam energy.

In most storage rings, if the bends have no quadrupole component, the damping partition number  $j_x \approx 1$ . In this case, we just need to evaluate the two synchrotron radiation integrals:

$$I_5 = \int \frac{\mathcal{H}_x}{\rho^3} ds \qquad I_2 = \int \frac{1}{\rho^2} ds$$

If we know the strength and length of all the dipoles in the lattice, it is straightforward to evaluate  $I_2$ .

Evaluating  $I_5$  is more complicated: it depends on the lattice functions...

# Case 1: natural emittance in a FODO lattice

Let us consider the case of a simple FODO lattice. To simplify this case, we will use the following approximations:

- the quadrupoles are represented as thin lenses;
- the space between the quadrupoles is completely filled by the dipoles.

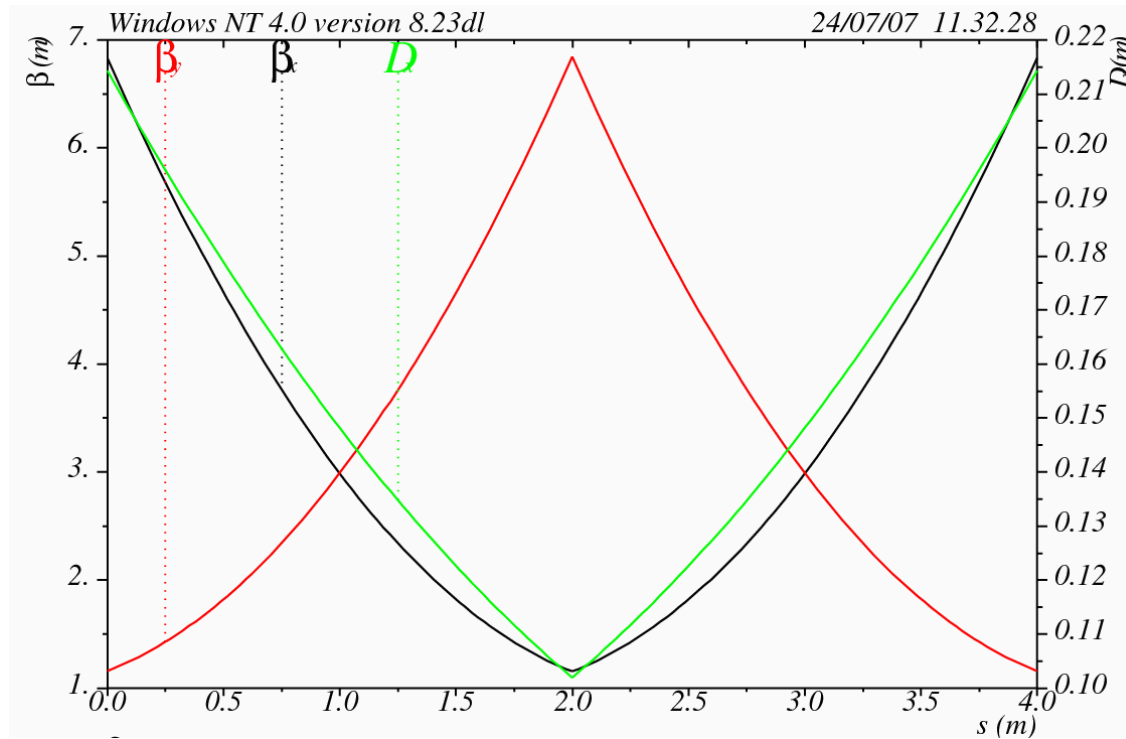

## Case 1: natural emittance in a FODO lattice

With the approximations in the previous slide, the lattice functions (Twiss parameters and dispersion) are completely determined by the following parameters:

- the focal length  $f$  of a quadrupole;
- the bending radius  $\rho$  of a dipole;
- the length  $L$  of a dipole.

The bending angle  $\theta$  of a dipole is given by:  $\theta = \frac{L}{\rho}$

In terms of these parameters, the horizontal beta function and dispersion at the centre of the horizontally-focusing quadrupole are given by:

$$\beta_x = \frac{4f\rho \sin\theta(2f \cos\theta + \rho \sin\theta)}{\sqrt{16f^4 - [\rho^2 - (4f^2 + \rho^2)\cos 2\theta]^2}} \quad \eta_x = \frac{2f\rho(2f + \rho \tan \frac{\theta}{2})}{4f^2 + \rho^2}$$

By symmetry, at the centre of a quadrupole,  $\alpha_x = \eta_{px} = 0$ .



## Case 1: natural emittance in a FODO lattice

We also know how to evolve the lattice functions through the lattice, using the transfer matrices,  $M$ .

For the Twiss parameters, we use:  $A(s) = M \cdot A(0) \cdot M^T$

where: 
$$A = \begin{pmatrix} \beta_x & -\alpha_x \\ -\alpha_x & \gamma_x \end{pmatrix}$$

The dispersion can be evolved using: 
$$\begin{pmatrix} \eta_x \\ \eta_{px} \end{pmatrix}_s = M \cdot \begin{pmatrix} \eta_x \\ \eta_{px} \end{pmatrix}_{s=0} + \begin{pmatrix} \rho(1 - \cos \frac{s}{\rho}) \\ \sin \frac{s}{\rho} \end{pmatrix}$$

For a thin quadrupole, the transfer matrix is given by: 
$$M = \begin{pmatrix} 1 & 0 \\ -1/f & 0 \end{pmatrix}$$

For a dipole, the transfer matrix is given by: 
$$M = \begin{pmatrix} \cos \frac{s}{\rho} & \rho \sin \frac{s}{\rho} \\ -\frac{1}{\rho} \sin \frac{s}{\rho} & \cos \frac{s}{\rho} \end{pmatrix}$$

## Case 1: natural emittance in a FODO lattice

---

With the expressions for the Twiss parameters and dispersion from the previous two slides, we can evaluate the synchrotron radiation integral  $I_5$ .

Note: by symmetry, we need to evaluate the integral in only one of the two dipoles in the FODO cell.

The algebra is rather formidable. The result is most easily expressed as a power series in the dipole bending angle  $\theta$ . We find that:

$$\frac{I_5}{I_2} = \left(4 + \frac{\rho^2}{f^2}\right)^{-\frac{3}{2}} \left[8 - \frac{\rho^2}{2f^2} \theta^2 + O(\theta^4)\right]$$

## Case 1: natural emittance in a FODO lattice

For small  $\theta$ , the expression for  $I_5/I_2$  can be written:

$$\frac{I_5}{I_2} \approx \left(1 - \frac{\rho^2}{16f^2} \theta^2\right) \left(1 + \frac{\rho^2}{4f^2}\right)^{-\frac{3}{2}} = \left(1 - \frac{L^2}{16f^2}\right) \left(1 + \frac{\rho^2}{4f^2}\right)^{-\frac{3}{2}}$$

This can be further simplified if  $\rho \gg 2f$  (which is often the case):

$$\frac{I_5}{I_2} \approx \left(1 - \frac{L^2}{16f^2}\right) \frac{8f^3}{\rho^3}$$

and still further if  $4f \gg L$  (which is less generally the case):

$$\frac{I_5}{I_2} \approx 8 \frac{f^3}{\rho^3}$$

Making the approximation  $j_x \approx 1$  (since we have no quadrupole component in the dipole), and writing  $\rho = L/\theta$ , we have:

$$\varepsilon_0 \approx C_q \gamma^2 \left(\frac{2f}{L}\right)^3 \theta^3 \quad \rho \gg 2f \gg L/2$$

## Case 1: natural emittance in a FODO lattice

We have derived an approximate expression for the natural emittance of a lattice consisting entirely of FODO cells:

$$\varepsilon_0 \approx C_q \gamma^2 \left( \frac{2f}{L} \right)^3 \theta^3$$

Notice how the emittance scales with the beam and lattice parameters:

- The emittance is proportional to the *square* of the energy.
- The emittance is proportional to the *cube* of the bending angle.  
Increasing the number of cells in a complete circular lattice reduces the bending angle of each dipole, and reduces the emittance.
- The emittance is proportional to the *cube* of the quadrupole focal length. Stronger quadrupoles have shorter focal lengths, and reduce the emittance.
- The emittance is inversely proportional to the *cube* of the cell (or dipole) length. Shortening the cell reduces the lattice functions, and reduces the emittance.

## Case 1: natural emittance in a FODO lattice

Recall that the phase advance in a FODO cell is given by:

$$\cos \mu_x = 1 - \frac{L^2}{2f^2}$$

This means that a stable lattice must have:  $\frac{f}{L} \geq \frac{1}{2}$

In the limiting case,  $\mu_x = 180^\circ$ , and we have the minimum value for  $f$ :  $f = \frac{L}{2}$

Using our approximation:

$$\varepsilon_0 \approx C_q \gamma^2 \left( \frac{2f}{L} \right)^3 \theta^3$$

this would suggest that the *minimum emittance in a FODO lattice* is given by:

$$\varepsilon_0 \approx C_q \gamma^2 \theta^3$$

However, as we increase the focusing strength, the approximations we used to obtain this simple form for  $\varepsilon_0$  break down...

## Case 1: natural emittance in a FODO lattice

Plotting the exact formula for  $I_5/I_2$ , as a function of the phase advance, we find there is a minimum in the natural emittance, for  $\mu \approx 137^\circ$ .

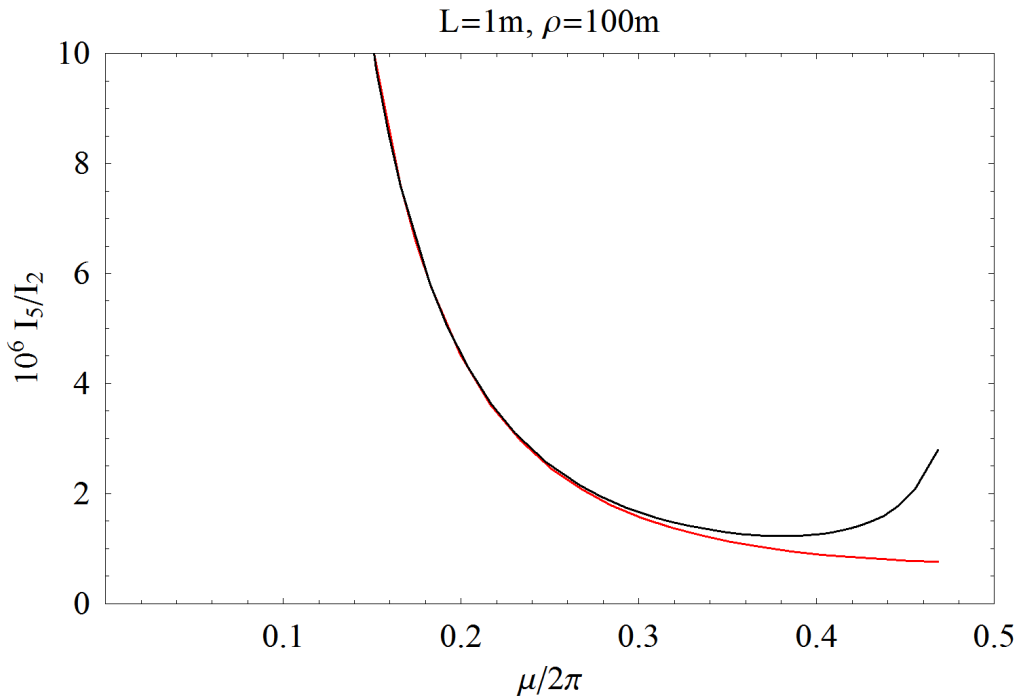

Black line: exact formula

Red line: approximation,

$$\frac{I_5}{I_2} \approx \left(1 - \frac{L^2}{16f^2}\right) \frac{8f^3}{\rho^3}$$

It turns out that the minimum value the natural emittance in a FODO cell is given by:

$$\varepsilon_0 \approx 1.2C_q\gamma^2\theta^3$$

## Case 1: natural emittance in a FODO lattice

A phase advance of  $137^\circ$  is quite high for a FODO cell. More typically, beam lines are designed with a phase advance of  $90^\circ$  per cell.

For a  $90^\circ$  FODO cell:

$$\cos \mu_x = 1 - \frac{L^2}{2f^2} = 0 \quad \therefore \quad \frac{f}{L} = \frac{1}{\sqrt{2}}$$

We are just in the regime where our approximation  $4f \gg L$  is valid; so in this case:

$$\varepsilon_0 \approx C_q \gamma^2 \left( \frac{2f}{L} \right)^3 \theta^3 = 2\sqrt{2} C_q \gamma^2 \theta^3$$

Using the above formulae, we estimate that a storage ring constructed from 16 FODO cells with  $90^\circ$  phase advance per cell, and storing beam at 2 GeV would have a natural emittance of 125 nm.

Many modern applications (including light sources and colliders) demand emittances one or two orders of magnitude smaller.

How can we design the lattice to achieve a smaller natural emittance?  
A clue is provided if we look at the curly-H function in a FODO lattice...

## Case 1: natural emittance in a FODO lattice

The curly-H function remains at a relatively constant value throughout the lattice. Perhaps we can reduce it in the dipoles...

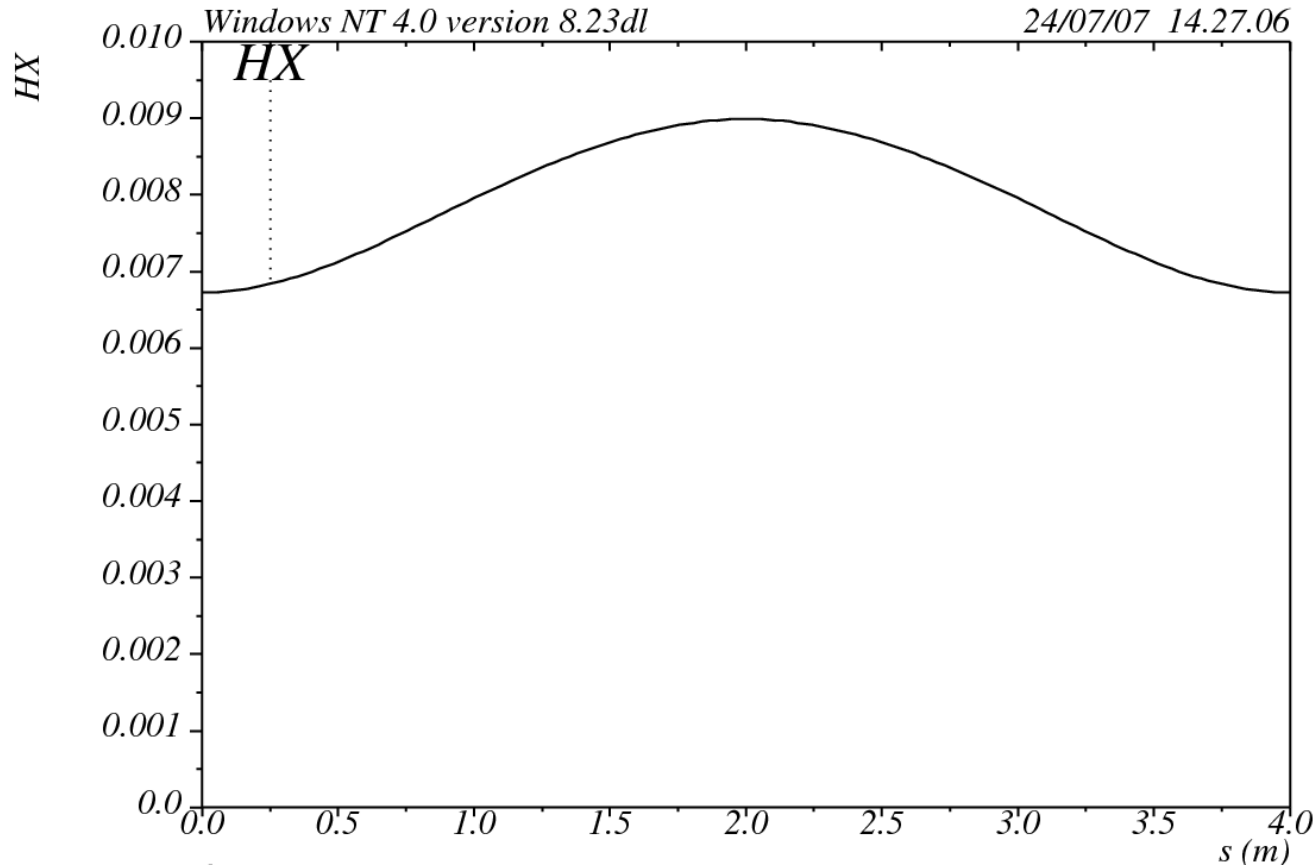



## Case 2: natural emittance in a DBA lattice

As a first attempt at reducing the natural emittance, let us try designing a lattice that has zero dispersion at one end of each dipole. This can be achieved using a double bend achromat (DBA) lattice.

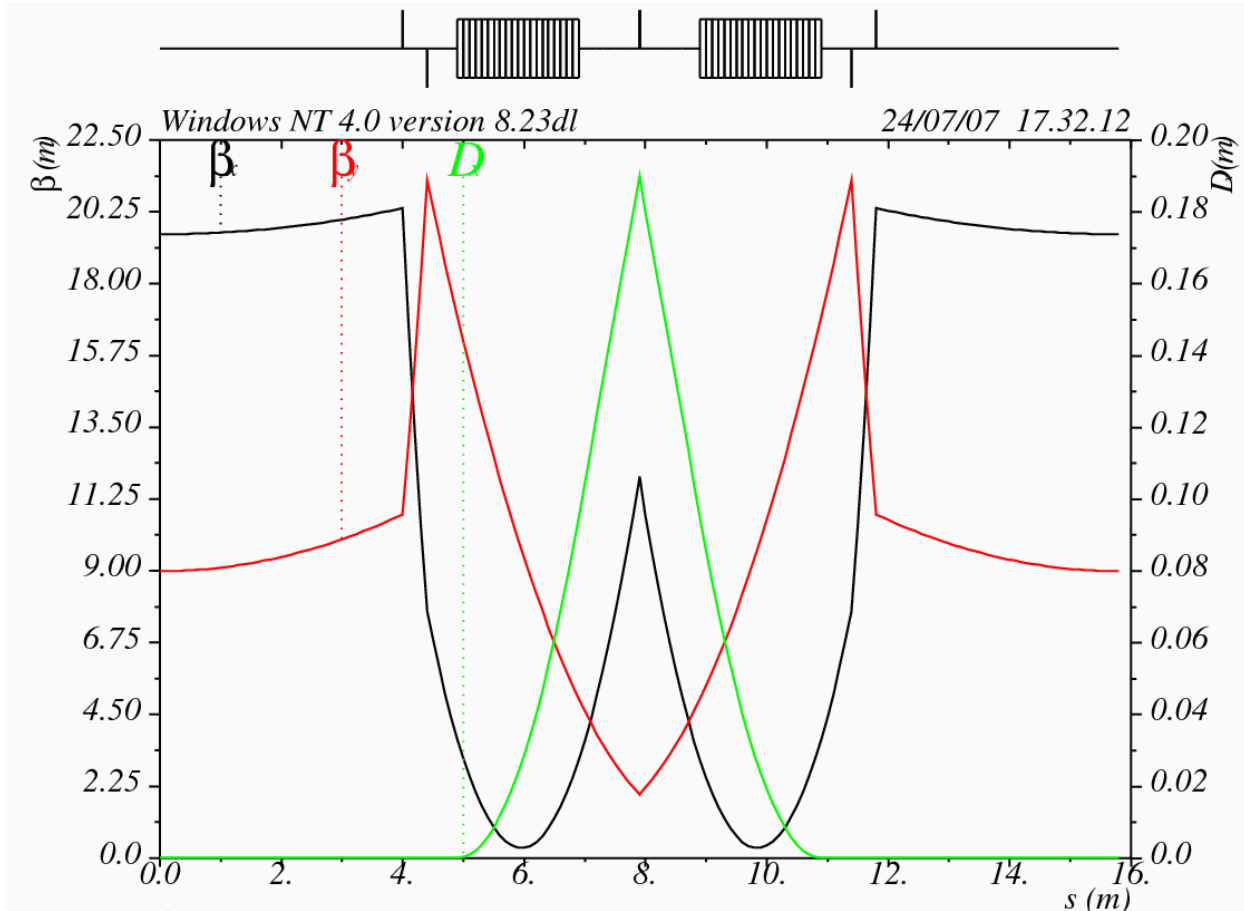

## Case 2: natural emittance in a DBA lattice

First of all, let us consider the constraints needed to achieve zero dispersion at either end of the cell.

Assuming that we start at one end of the cell with zero dispersion, then, by symmetry, the dispersion at the other end of the cell will also be zero if the central quadrupole simply reverses the gradient of the dispersion.

In the thin lens approximation, this condition can be written:

$$\begin{pmatrix} 1 & 0 \\ -1/f & 0 \end{pmatrix} \cdot \begin{pmatrix} \eta_x \\ \eta_{px} \end{pmatrix} = \begin{pmatrix} \eta_x \\ \eta_{px} - \frac{\eta_x}{f} \end{pmatrix} = \begin{pmatrix} \eta_x \\ -\eta_{px} \end{pmatrix}$$

Hence, the central quadrupole must have focal length:  $f = \frac{\eta_x}{2\eta_{px}}$

The actual value of the dispersion is determined by the dipole bending angle  $\theta$ , the bending radius  $\rho$ , and the drift length  $L$ :

$$\eta_x = \rho(1 - \cos\theta) + L \sin\theta \quad \eta_{px} = \sin\theta$$

## Case 2: natural emittance in a DBA lattice

Is this type of lattice likely to have a lower natural emittance than a FODO lattice? We can get an idea by looking at the curly-H function.

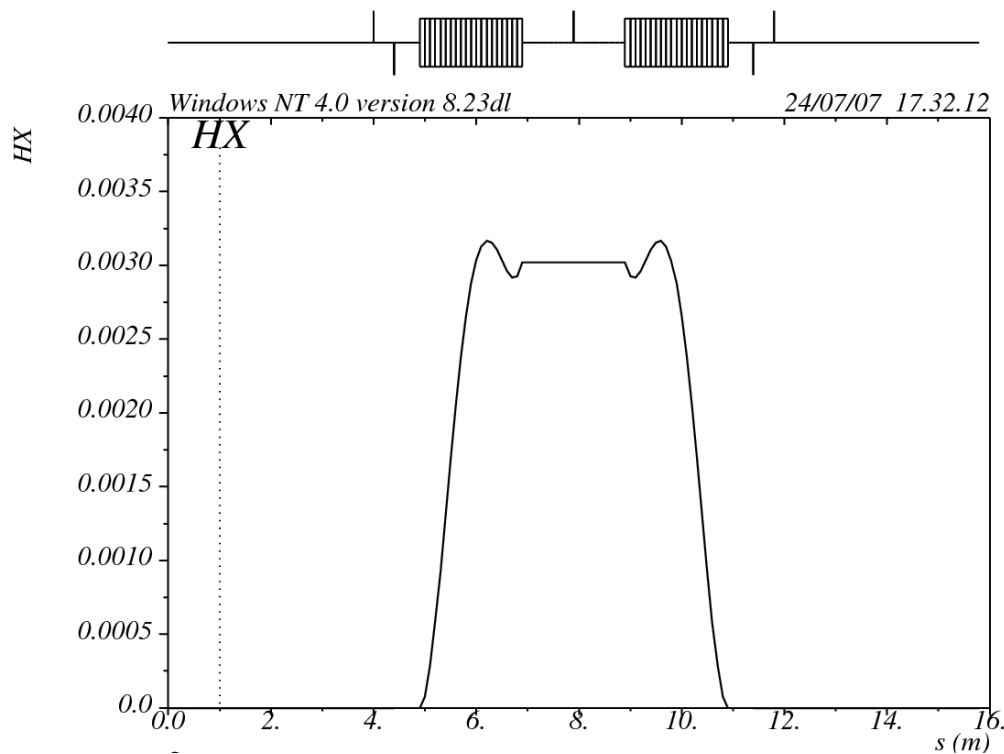

Note that we use the same dipoles (bending radius and length) for our example in both cases (FODO and DBA). In the DBA lattice the curly-H function is reduced by a significant factor, compared to the FODO lattice.

## Case 2: natural emittance in a DBA lattice

Let us calculate the minimum natural emittance of a DBA lattice, for given bending radius  $\rho$  and bending angle  $\theta$  in the dipoles.

To do this, we need to calculate the minimum value of:

$$I_5 = \int \frac{\mathcal{H}_x}{\rho^3} ds$$

in one dipole, subject to the constraints:

$$\eta_0 = \eta_{p0} = 0$$

where  $\eta_0$  and  $\eta_{p0}$  are the dispersion and the gradient of the dispersion at the entrance of a dipole.

We know how the dispersion and the Twiss parameters evolve through the dipole, so we can calculate  $I_5$  for one dipole, for given initial values of the Twiss parameters  $\alpha_0$  and  $\beta_0$ .

Then, we simply have to minimise the value of  $I_5$  with respect to  $\alpha_0$  and  $\beta_0$ .

Again, the algebra is rather formidable, and the full expression for  $I_5$  is not especially enlightening...

## Case 2: natural emittance in a DBA lattice

We find that, for given  $\rho$  and  $\theta$  and with the constraints:

$$\eta_0 = \eta_{p0} = 0$$

the minimum value of  $I_5$  is given by:

$$I_{5,\min} = \frac{1}{4\sqrt{15}} \frac{\theta^4}{\rho} + O(\theta^6)$$

which occurs for values of the Twiss parameters at the entrance to the dipole:

$$\beta_0 = \sqrt{\frac{12}{5}} L + O(\theta^3) \quad \alpha_0 = \sqrt{15} + O(\theta^2)$$

where  $L = \rho\theta$  is the length of a dipole.

Since:

$$I_2 = \int \frac{1}{\rho^2} ds = \frac{\theta}{\rho}$$

we can immediately write an expression for the minimum emittance in a DBA lattice...

## Case 2: natural emittance in a DBA lattice

$$\mathcal{E}_{0,DBA,\min} = C_q \gamma^2 \frac{I_{5,\min}}{j_x I_2} \approx \frac{1}{4\sqrt{15}} C_q \gamma^2 \theta^3$$

The approximation is valid for small  $\theta$ . Note that we have again assumed that, since there is no quadrupole component in the dipole,  $j_x \approx 1$ .

Compare the above expression with that for the minimum emittance in a FODO lattice:

$$\mathcal{E}_{0,FODO,\min} \approx C_q \gamma^2 \theta^3$$

The minimum emittance in each case scales with the square of the beam energy, and with the cube of the bending angle of a dipole. However, the minimum emittance in a DBA lattice is smaller than that in a FODO lattice (for given energy and dipole bending angle) by a factor  $4\sqrt{15} \approx 15.5$ .

This is a significant improvement... but can we do even better?

## Case 3: natural emittance in a TME lattice

We used the constraints:

$$\eta_0 = \eta_{p0} = 0$$

to define a DBA lattice; but to get a lower emittance, we can consider relaxing these constraints.

If we relax these constraints, then we may be able to achieve an even lower natural emittance.

To derive the “theoretical minimum emittance” (TME), we write down an expression for:

$$I_5 = \int \frac{\mathcal{H}_x}{\rho^3} ds$$

with arbitrary initial dispersion  $\eta_0$ ,  $\eta_{p0}$ , and Twiss parameters  $\alpha_0$  and  $\beta_0$  in a dipole with given bending radius  $\rho$  and angle  $\theta$ .

Then we minimise  $I_5$  with respect to variations in  $\eta_0$ ,  $\eta_{p0}$ ,  $\alpha_0$  and  $\beta_0$ ...

## Case 3: natural emittance in a TME lattice

The result is:

$$\varepsilon_{0,TME,\min} \approx \frac{1}{12\sqrt{15}} C_q \gamma^2 \theta^3$$

The minimum emittance is obtained with dispersion at the entrance to a dipole:

$$\eta_0 = \frac{1}{6} L \theta + O(\theta^3) \qquad \eta_{p0} = -\frac{\theta}{2} + O(\theta^3)$$

and with Twiss functions at the entrance:

$$\beta_0 = \frac{8}{\sqrt{15}} L + O(\theta^3) \qquad \alpha_0 = \sqrt{15} + O(\theta^2)$$



## Case 3: natural emittance in a TME lattice

Note that with the conditions for minimum emittance:

$$\eta_0 = \frac{1}{6}L\theta + O(\theta^3) \quad \eta_{p0} = -\frac{\theta}{2} + O(\theta^3)$$
$$\beta_0 = \frac{8}{\sqrt{15}}L + O(\theta^3) \quad \alpha_0 = \sqrt{15} + O(\theta^2)$$

the dispersion and the beta function reach a minimum in the centre of the dipole. The values at the centre of the dipole are:

$$\eta_{\min} = \rho \left( 1 - 2 \frac{\sin \frac{\theta}{2}}{\theta} \right) = \frac{L\theta}{24} + O(\theta^4)$$
$$\beta_{\min} = \frac{L}{2\sqrt{15}} + O(\theta^3)$$

What do the lattice functions look like in a single cell of a TME lattice?

Because of symmetry in the dipole, we can consider a TME lattice cell as containing a single dipole (as opposed to two dipoles, which we had in the cases of the FODO and DBA lattices)...

## Case 3: natural emittance in a TME lattice

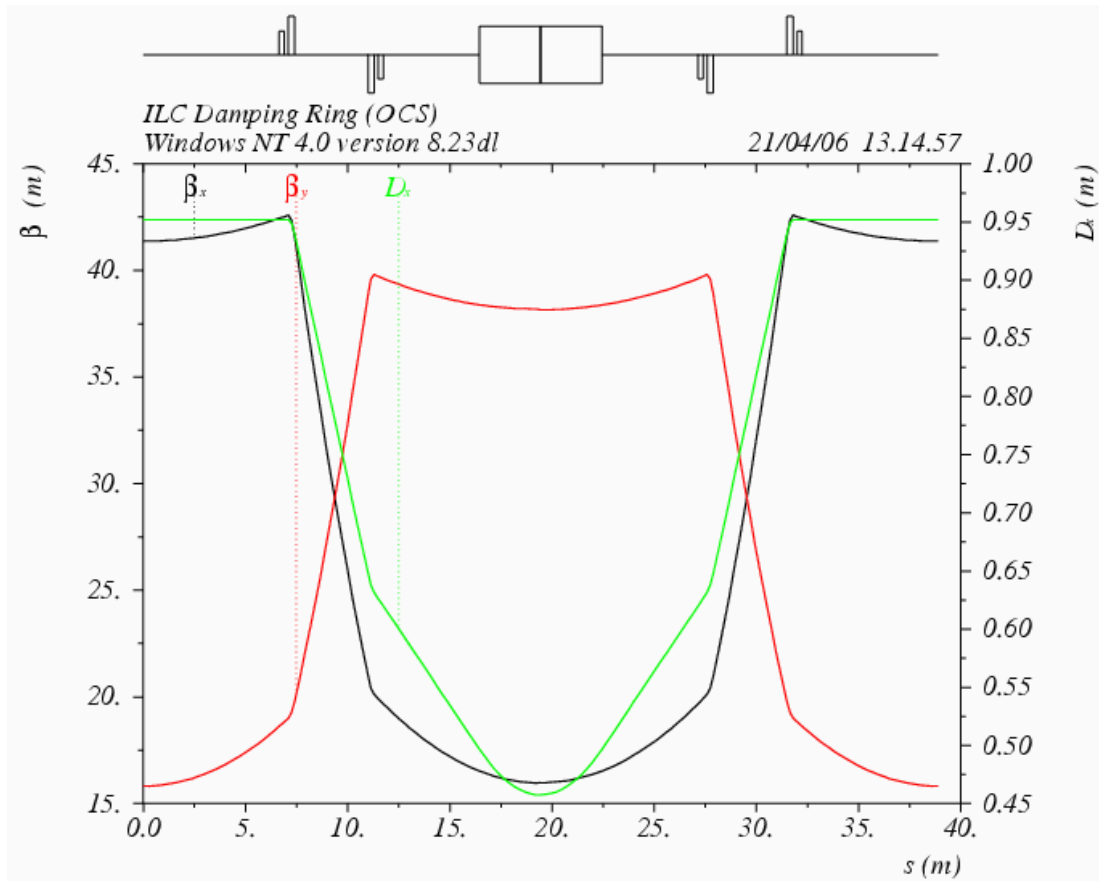

*Note: the lattice shown in this example does not actually achieve the exact conditions needed for absolute minimum emittance. A more complicated lattice would be needed for this...*

## Summary: natural emittance in FODO, DBA and TME lattices

Lattice Style	Minimum Emittance	Conditions
90 FODO	$\varepsilon_0 \approx 2\sqrt{2}C_q\gamma^2\theta^3$	$\frac{f}{L} = \frac{1}{\sqrt{2}}$
Minimum emittance FODO	$\varepsilon_0 \approx 1.2C_q\gamma^2\theta^3$	$\mu \approx 137^\circ$
DBA	$\varepsilon_0 \approx \frac{1}{4\sqrt{15}}C_q\gamma^2\theta^3$	$\eta_0 = \eta_{p0} = 0$ $\beta_0 \approx \sqrt{12/5}L$ $\alpha_0 \approx \sqrt{15}$
TME	$\varepsilon_0 \approx \frac{1}{12\sqrt{15}}C_q\gamma^2\theta^3$	$\eta_{\min} \approx \frac{L\theta}{24}$ $\beta_{\min} \approx \frac{L}{2\sqrt{15}}$

Note: the approximations are valid for small dipole bending angle,  $\theta$ .

# Comments on lattice design for low emittance lattices

---

The results we have derived have been for "ideal" lattices that perfectly achieve the stated conditions in each case.

In practice, lattices rarely, if ever, achieve the ideal conditions. In particular, the beta function in an achromat is usually not optimal for low emittance; and the dispersion and beta function in a TME lattice are not optimal.

The main reasons for this are:

- It is difficult to control the beta function and dispersion to achieve the ideal low-emittance conditions with a small number of quadrupoles.
- There are other strong dynamical constraints on the design that we have not considered: in particular, the lattice needs a large dynamic aperture to achieve a good beam lifetime.

The dynamic aperture issue is particularly difficult for low emittance lattices. The dispersion in low emittance lattices is generally low, while the strong focusing leads to high chromaticity. Therefore, very strong sextupoles are often needed to correct the natural chromaticity. This limits the dynamic aperture.

The consequence of all these issues is that in practice, the natural emittance of a lattice of a given type is usually somewhat larger than might be expected using the formulae given here.

# Further Options and Issues

---

We have derived the main results for this lecture.

However, there are (of course) many other options besides FODO, DBA and TME for the lattice "style".

In the remainder of this lecture, we will discuss:

- Use of the DBA lattice in third-generation synchrotron light sources.
- Detuning the DBA to reduce the emittance.
- Use of multi-bend achromats to reduce the emittance.

See the Appendix for:

- Effects of insertion devices on the natural emittance in a storage ring.
- Natural emittance in wiggler-dominated storage rings.

# DBA lattices in third generation synchrotron light sources

Lattices composed of DBA cells have been a popular choice for third generation synchrotron light sources.

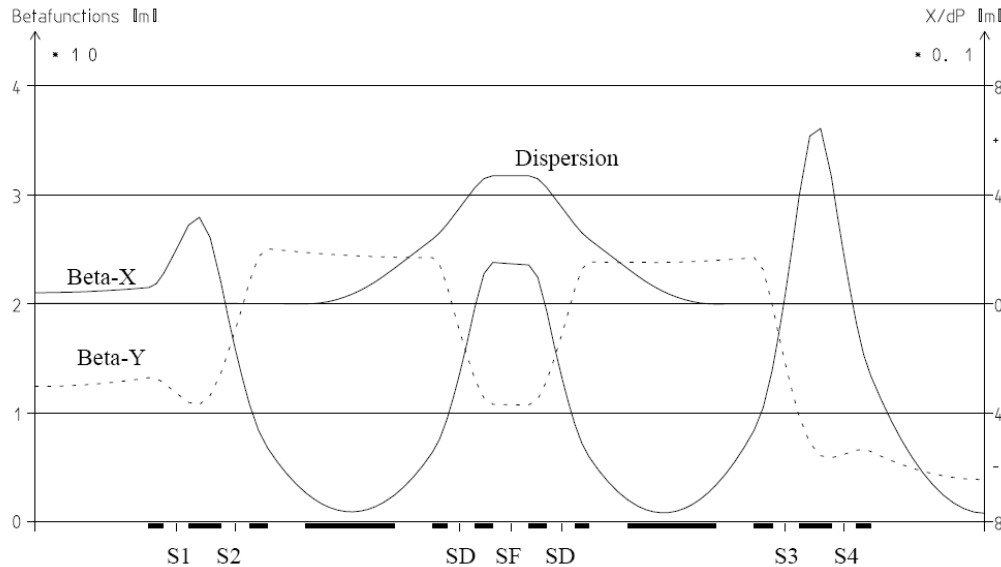

*Lattice functions in an early version of the ESRF lattice.*

The DBA structure provides a lower natural emittance than a FODO lattice with the same number of dipoles

The long, dispersion-free straight sections provide ideal locations for insertion devices such as undulators and wigglers.

## “Detuning” the DBA lattice

---

If an insertion device, such as an undulator or wiggler, is incorporated in a storage ring at a location with large dispersion, then the dipole fields in the device can make a significant contribution to the quantum excitation ( $I_5$ ).

As a result, the insertion device can lead to an increase in the natural emittance of the storage ring.

By using a DBA lattice, we provide dispersion-free straights in which we can locate undulators and wigglers without blowing up the natural emittance.

However, there is some tolerance. In many cases, it is possible to “detune” the lattice from the strict DBA conditions, thereby allowing some reduction in natural emittance at the cost of some dispersion in the straights.

The insertion devices will then contribute to the quantum excitation; but depending on the lattice and the insertion devices, there may still be a net benefit in the reduction of the natural emittance compared to a lattice with zero dispersion in the straights.

# “Detuning” the DBA lattice

Some light sources that were originally designed with zero-dispersion straights take advantage of tuning flexibility to operate routinely with dispersion in the straights, thus achieving lower natural emittance and providing better output for users.

For example, the ESRF...

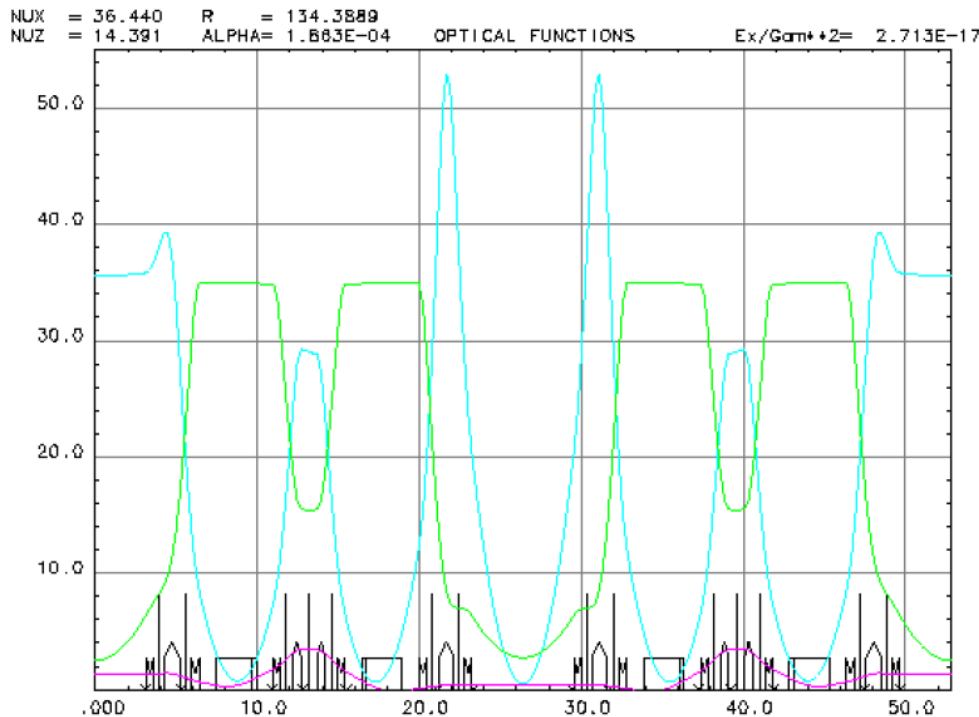



## Multi-bend achromats

---

In principle, it is possible to combine the DBA and TME lattices by having an arc cell consisting of more than two dipoles.

- The dipoles at either end of the cell have zero dispersion (and gradient of the dispersion) at their outside faces, thus satisfying the “achromat” condition.
- The lattice is tuned so that in the “central” dipoles, the Twiss parameters and dispersion satisfy the TME conditions.

Since the lattice functions are different in the central dipoles compared to the end dipoles, we have additional degrees of freedom we can use to minimise the quantum excitation.

Therefore, it is possible to have cases where the end dipoles and central dipoles differ in:

- the bend angle (i.e. length of dipole), and/or
- the bend radius (i.e. strength of dipole).

## Multi-bend achromats

For simplicity, let us consider the case where the dipoles all have the same bending radius (i.e. they all have the same field strength), but vary in length.

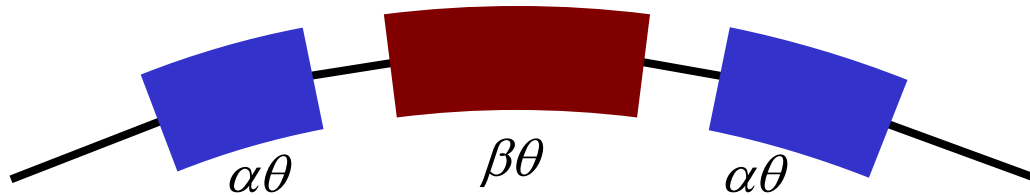

Assuming each arc cell has a fixed number,  $M$ , of dipoles, the bending angles must satisfy:

$$2\alpha + (M - 2)\beta = M$$

Since the synchrotron radiation integrals are additive, for an  $M$ -bend achromat we can write:

$$I_{5,cell} \approx 2 \frac{1}{4\sqrt{15}} \frac{(\alpha\theta)^4}{\rho} + (M - 2) \frac{1}{12\sqrt{15}} \frac{(\beta\theta)^4}{\rho} = \frac{6\alpha^4 + (M - 2)\beta^4}{12\sqrt{15}} \frac{\theta^4}{\rho}$$

$$I_{2,cell} = 2 \frac{\alpha\theta}{\rho} + (M - 2) \frac{\beta\theta}{\rho} = [2\alpha + (M - 2)\beta] \frac{\theta}{\rho}$$

## Multi-bend achromats

Hence, in an  $M$ -bend achromat,

$$\frac{I_{5,cell}}{I_{2,cell}} \approx \frac{1}{12\sqrt{15}} \left[ \frac{6\alpha^4 + (M-2)\beta^4}{2\alpha + (M-2)\beta} \right] \theta^3$$

Minimising the ratio  $I_5/I_2$  with respect to  $\alpha$  gives:

$$\frac{\alpha}{\beta} = \frac{1}{\sqrt[3]{3}} \quad \frac{6\alpha^4 + (M-2)\beta^4}{2\alpha + (M-2)\beta} \approx \frac{M+1}{M-1}$$

Hence, the natural emittance in an  $M$ -bend achromat is given by:

$$\varepsilon_0 \approx C_q \gamma^2 \frac{1}{12\sqrt{15}} \frac{M+1}{M-1} \theta^3 \quad 2 < M < \infty$$

Note that  $\theta$  is the *average* bending angle per dipole: the central bending magnets should be longer than the outer bending magnets by a factor  $\sqrt[3]{3}$ .

Of course, the emittance can always be reduced by "detuning" the achromat to allow dispersion in the straights...

# Example of a Triple-Bend Achromat: the Swiss Light Source

The storage ring in the Swiss Light Source consists of 12 TBA cells, has a circumference of 288 m, and beam energy 2.4 GeV.

In the "zero dispersion" mode, the natural emittance is 4.8 nm·rad.

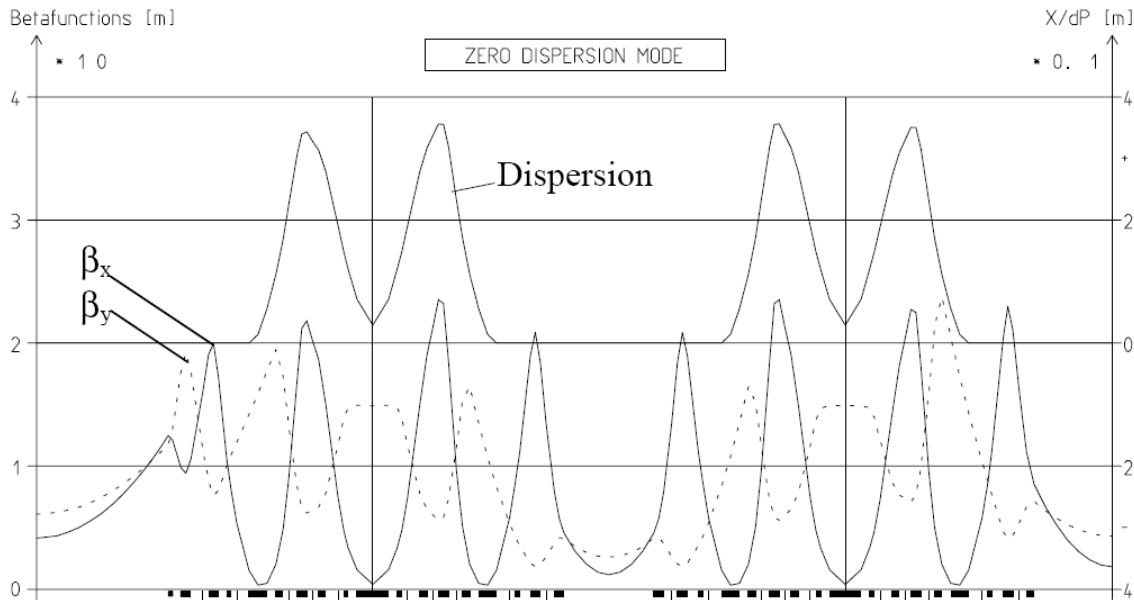

# Example of a Triple-Bend Achromat: the Swiss Light Source

Detuning the achromat to allow dispersion in the straights reduces the natural emittance from 4.8 nm·rad to 3.9 nm·rad (a reduction of about 20% compared to the zero-dispersion case).

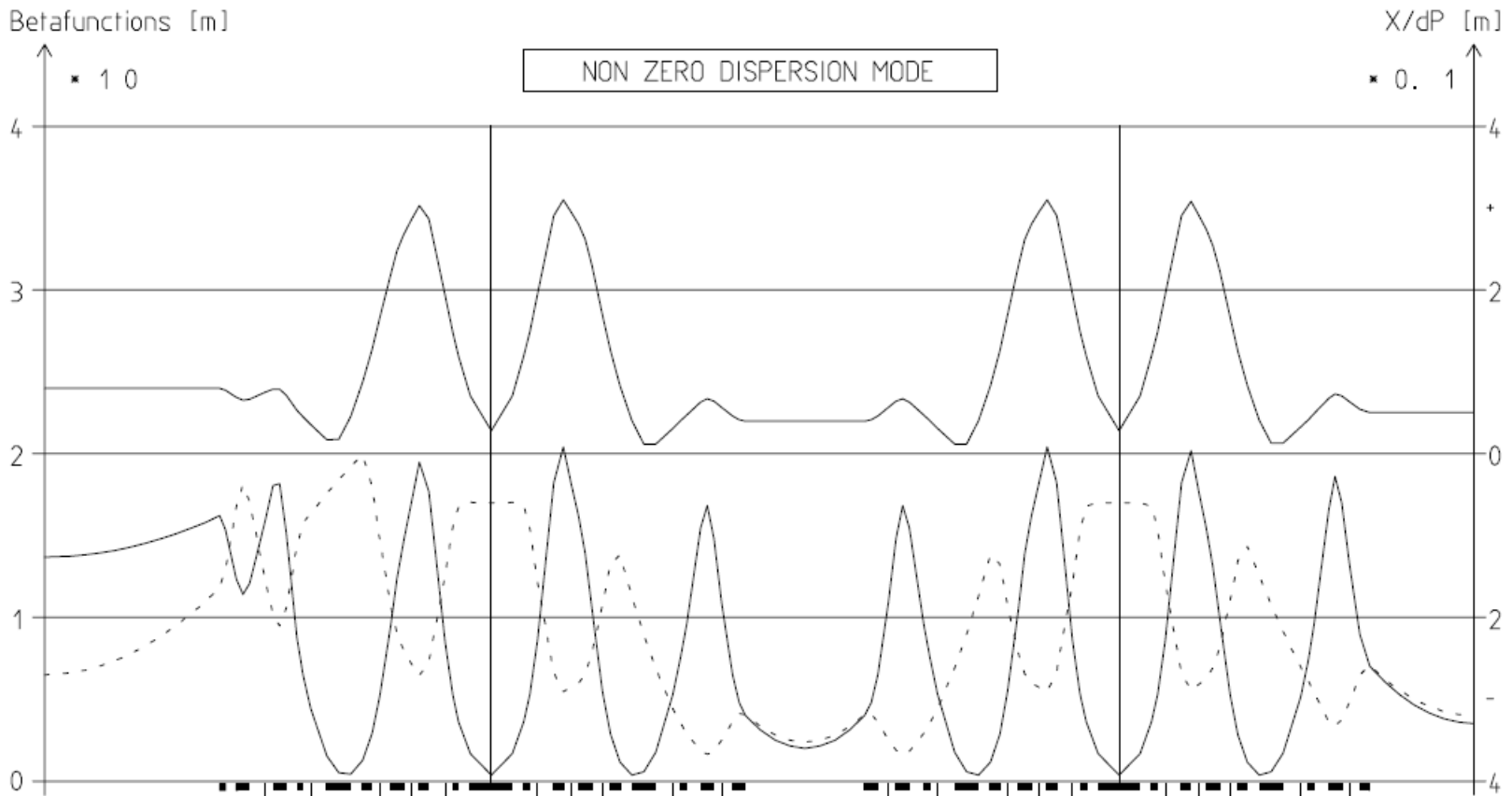

# Summary 1

The natural emittance in a storage ring is determined by the balance between the radiation damping (given by  $I_2$ ) and the quantum excitation (given by  $I_5$ ).

The quantum excitation depends on the lattice functions. Different "styles" of lattice can be used, depending on the emittance specification for the storage ring.

In general, for small bending angle  $\theta$  the natural emittance can be written as:

$$\varepsilon_0 \approx FC_q \gamma^2 \theta^3$$

where  $\theta$  is the bending angle of a single dipole, and the numerical factor  $F$  is determined by the lattice style:

Lattice style	$F$
90 FODO	$2\sqrt{2}$
180 FODO	1
Double-bend achromat (DBA)	$1/4\sqrt{15}$
Multi-bend achromat	$(M+1)/12\sqrt{15}(M-1)$
Theoretical minimum emittance (TME)	$1/12\sqrt{15}$

## Summary 2

---

Achromats have been popular choices for storage ring lattices in third-generation synchrotron light sources for two reasons:

- they provide lower natural emittance than FODO lattices;
- they provide zero-dispersion locations appropriate for insertion devices (wigglers and undulators).

Light sources using double-bend achromats (e.g. ESRF, APS, SPring-8, DIAMOND, SOLEIL...) and triple-bend achromats (e.g. ALS, SLS) have been built.

Increasing the number of bends in a single cell of an achromat ("multiple-bend achromats") reduces the emittance, since the lattice functions in the "central" bends can be tuned to conditions for minimum emittance.

"Detuning" an achromat to allow some dispersion in the straights provides the possibility of further reduction in natural emittance, by moving towards the conditions for a theoretical minimum emittance (TME) lattice.

# Appendix



## Appendix A: Effect of insertion devices on the natural emittance

Insertion devices such as wigglers and undulators are commonly used in third generation light sources to generate radiation with particular properties.

Usually, insertion devices are designed so that the integral of the field along the length of the device is zero: therefore, the overall geometry of the machine is not changed. However, since they produce radiation, they will contribute to the synchrotron radiation integrals, and hence affect the natural emittance of the lattice.

If a wiggler or undulator is inserted at a location with zero dispersion, then in the approximation that we neglect the dispersion generated by the device itself, there will be no contribution to  $I_5$ ; however, there will be a non-zero contribution to  $I_2$  (the energy loss of a particle).

Hence, since the natural emittance is given by the ratio  $I_5/I_2$ , wigglers and undulators can reduce the natural emittance of the beam. In effect, they enhance the radiation damping while making little contribution to the quantum excitation.

However, to obtain a reasonably accurate value for the natural emittance, we have to consider the dispersion generated by the insertion device itself.

# Appendix A: A simple model of a wiggler

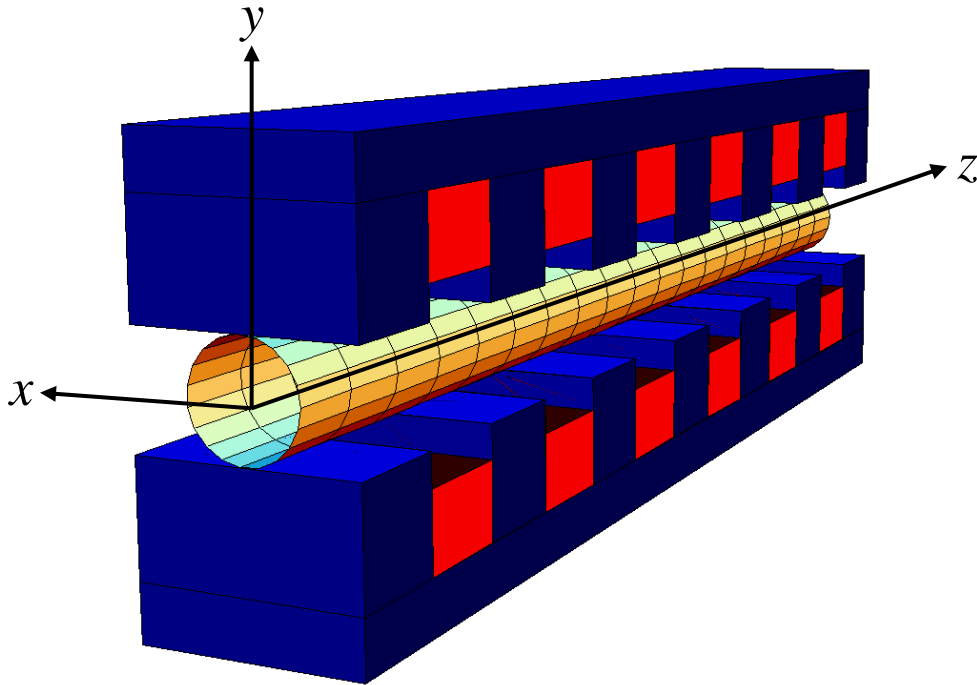

$$B_y = B_w \sin(k_z z)$$

$$\text{Peak field} = B_w$$

$$\text{Period} = \lambda_w = \frac{2\pi}{k_z}$$

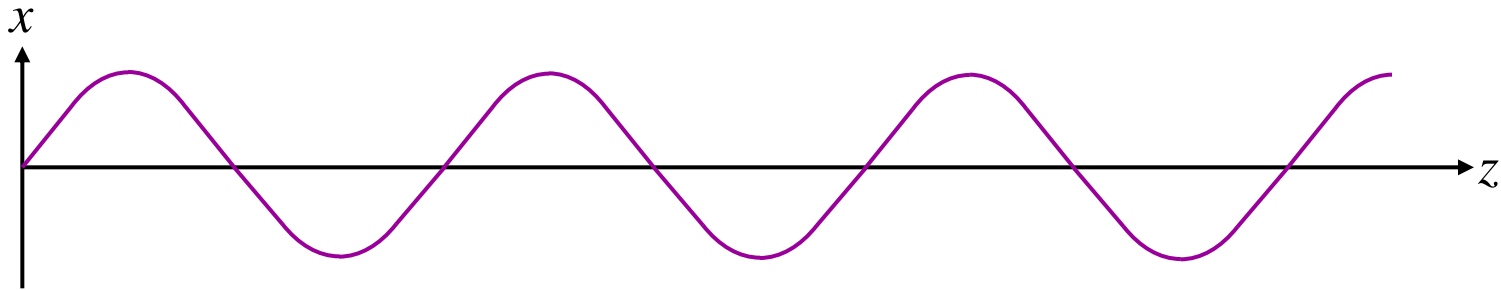

## Appendix A: Wigglers increase the energy loss from synchrotron radiation

The total energy loss per turn is given in terms of the second synchrotron radiation integral:

$$U_0 = \frac{C_\gamma}{2\pi} E_0^4 I_2 \qquad I_2 = \oint \frac{1}{\rho^2} ds$$

The integral extends over the entire circumference of the ring. The contribution from the wigglers is:

$$I_{2w} = \int_0^{L_w} \frac{1}{\rho^2} ds = \frac{1}{(B\rho)^2} \int_0^{L_w} B^2 ds \approx \frac{1}{(B\rho)^2} \frac{B_w^2 L_w}{2}$$

The approximation comes from the fact that we neglect end effects.

Note that  $I_{2w}$  depends only on the peak field and the total length of wiggler (and the beam energy), and is independent of the wiggler period.

# Appendix A: Wiggler contribution to the natural emittance

The natural emittance depends on the second and fifth synchrotron radiation integrals:

$$\varepsilon_0 = C_q \gamma^2 \frac{I_5}{j_x I_2} \quad C_q = 3.832 \times 10^{-13} \text{ m}$$

$$I_2 = \oint \frac{1}{\rho^2} ds \quad I_5 = \oint \frac{\mathcal{H}_x}{|\rho|^3} ds \quad \mathcal{H}_x = \gamma_x \eta_x^2 + 2\alpha_x \eta_x \eta_{px} + \beta_x \eta_{px}^2$$

The contribution of the wiggler to  $I_5$  depends on the beta function in the wiggler. Let us assume that the beta function is constant (or changing slowly), so  $\alpha_x \approx 0$ .

Then, to calculate  $I_5$ , we just need to know the dispersion...

## Appendix A: Dispersion generated in a wiggler

In a dipole of bending radius  $\rho$  and quadrupole gradient  $k_1$ , the dispersion obeys the equation:

$$\frac{d^2\eta_x}{ds^2} + K\eta_x = \frac{1}{\rho} \quad K = \frac{1}{\rho^2} + k_1$$

Assuming that  $k_1 = 0$  in the wiggler, we can write the equation for  $\eta_x$  as:

$$\frac{d^2\eta_x}{ds^2} + \frac{B_w^2}{(B\rho)^2}\eta_x \sin^2 k_w s = \frac{B_w}{B\rho} \sin k_w s$$

For  $k_w \rho_w \gg 1$ , we can neglect the second term on the left, and we find:

$$\eta_x \approx -\frac{\sin k_w s}{\rho_w k_w^2} \quad \eta_{px} \approx -\frac{\cos k_w s}{\rho_w k_w}$$

## Appendix A: Wiggler contribution to the natural emittance

The wiggler contribution to  $I_5$  can be written:

$$I_{5w} \approx \int_0^{L_w} \frac{\beta_x \eta_{px}^2}{|\rho|^3} ds \approx \frac{\langle \beta_x \rangle}{\rho_w^2 k_w^2} \int_0^{L_w} \frac{\cos^2 k_w s}{|\rho|^3} ds = \frac{\langle \beta_x \rangle}{\rho_w^5 k_w^2} \int_0^{L_w} |\sin^3 k_w s| \cos^2 k_w s ds$$

Using:

$$\left\langle |\sin^3 k_w s| \cos^2 k_w s \right\rangle = \frac{4}{15\pi}$$

we have:

$$I_{5w} \approx \frac{4}{15\pi} \frac{\langle \beta_x \rangle L_w}{\rho_w^5 k_w^2}$$

## Appendix A: Natural emittance in a wiggler-dominated storage ring

Combining expressions for  $I_{2w}$  and  $I_{5w}$ , *then, in the case that the wiggler dominates the contributions to  $I_2$  and  $I_5$* , we can write for the natural emittance:

$$\varepsilon_0 \approx \frac{8}{15\pi} C_q \gamma^2 \frac{\langle \beta_x \rangle}{\rho_w^3 k_w^2}$$

Using short period, high field wigglers, we can achieve small emittances, if the wigglers are placed at locations with small horizontal beta function.

Note that in the vast majority of electron storage rings, insertion devices only account for 10% - 20% of the synchrotron radiation energy loss: so the above formula cannot be used to calculate the emittance.

However, in the damping rings of a future linear collider, wigglers would account for around 90% of the synchrotron radiation energy loss. The natural emittance will be dominated by the wiggler parameters.

## Appendix A: Wiggler contribution to the natural energy spread

The natural energy spread is given in terms of the second and third synchrotron radiation integrals:

$$\sigma_{\delta}^2 = C_q \gamma^2 \frac{I_3}{j_z I_2} \quad I_3 = \oint \frac{1}{|\rho|^3} ds \quad C_q = 3.832 \times 10^{-13} \text{ m}$$

Since  $I_3$  does not depend on the dispersion, the wiggler potentially makes a significant contribution to the energy spread. Writing for the bending radius in the wiggler:

$$\frac{1}{\rho} = \frac{B}{B\rho} = \frac{B_w}{B\rho} \sin k_w s = \frac{1}{\rho_w} \sin k_w s$$

we find:

$$I_{3w} = \frac{1}{\rho_w^3} \int_0^{L_w} |\sin^3 k_w s| ds = \frac{4L_w}{3\pi\rho_w^3}$$

If the wiggler dominates the synchrotron radiation energy loss, then the natural energy spread in the ring will be given by:

$$\sigma_{\delta}^2 \approx \frac{4}{3\pi} C_q \frac{\gamma^2}{\rho_w} = \frac{4}{3\pi} \frac{e}{mc} C_q \gamma B_w$$