

# LONGITUDINAL DYNAMICS

by

Joël Le DuFF

(Retired from LAL-Orsay)

**CAS on Intermediate Level Accelerator Physics Course  
Darmstadt, 28 September - 8 October 2009**

# summary

Radio-Frequency Acceleration and Synchronism Condition  
Principle of Phase Stability and Consequences  
The Synchrotron  
Dispersion Effects in Synchrotron  
Energy-Phase Equations  
Longitudinal Phase Space Motion  
Particularities of the electron Synchrotron  
From Synchrotron to Linac  
Adiabatic Damping  
Dynamics in the vicinity of transition energy  
Stationnary Bucket

# Bibliography : Old Books

- M. Stanley Livingston      **High Energy Accelerators**  
(Interscience Publishers, 1954)
- J.J. Livingood              **Principles of cyclic Particle Accelerators**  
(D. Van Nostrand Co Ltd , 1961)
- M. Stanley Livingston and J. B. Blewett      **Particle Accelerators**  
(Mc Graw Hill Book Company, Inc 1962)
- K.G. Steffen                **High Energy optics**  
(Interscience Publisher, J. Wiley & sons, 1965)
- H. Bruck                     **Accelérateurs circulaires de particules**  
(PUF, Paris 1966)
- M. Stanley Livingston (editor)      **The development of High Energy Accelerators**  
(Dover Publications, Inc, N. Y. 1966)
- A.A. Kolomensky & A.W. Lebedev      **Theory of cyclic Accelerators**  
(North Holland Publishers Company, Amst. 1966)
- E. Persico, E. Ferrari, S.E. Segre      **Principles of Particles Accelerators**  
(W.A. Benjamin, Inc. 1968)
- P.M. Lapostolle & A.L. Septier      **Linear Accelerators**  
(North Holland Publishers Company, Amst. 1970)
- A.D. Vlasov                 **Theory of Linear Accelerators**  
(Programm for scientific translations, Jerusalem 1968)

## Bibliography : New Books

- M. Conte, W.W. Mac Kay    **An Introduction to the Physics of particle Accelerators**  
(World Scientific, 1991)
- P. J. Bryant and K. Johnsen    **The Principles of Circular Accelerators and Storage Rings**  
(Cambridge University Press, 1993)
- D. A. Edwards, M. J. Syphers    **An Introduction to the Physics of High Energy Accelerators**  
(J. Wiley & sons, Inc, 1993)
- H. Wiedemann    **Particle Accelerator Physics**  
(Springer-Verlag, Berlin, 1993)
- M. Reiser    **Theory and Design of Charged Particles Beams**  
(J. Wiley & sons, 1994)
- A. Chao, M. Tigner    **Handbook of Accelerator Physics and Engineering**  
(World Scientific 1998)
- K. Wille    **The Physics of Particle Accelerators: An Introduction**  
(Oxford University Press, 2000)
- E.J.N. Wilson    **An introduction to Particle Accelerators**  
(Oxford University Press, 2001)



**And CERN Accelerator Schools (CAS) Proceedings**

# Main Characteristics of an Accelerator

**ACCELERATION** is the main job of an accelerator.

- The accelerator provides **kinetic energy** to charged particles, hence increasing their **momentum**.
- In order to do so, it is necessary to have an electric field  $\vec{E}$ , preferably along the direction of the initial momentum.

$$\frac{dp}{dt} = eE$$

**BENDING** is generated by a magnetic field perpendicular to the plane of the particle trajectory. The bending radius  $\rho$  obeys to the relation :

$$\frac{p}{e} = B\rho$$

**FOCUSING** is a second way of using a magnetic field, in which the bending effect is used to bring the particles trajectory closer to the axis, hence to increase the beam density.

# Radio-Frequency Acceleration

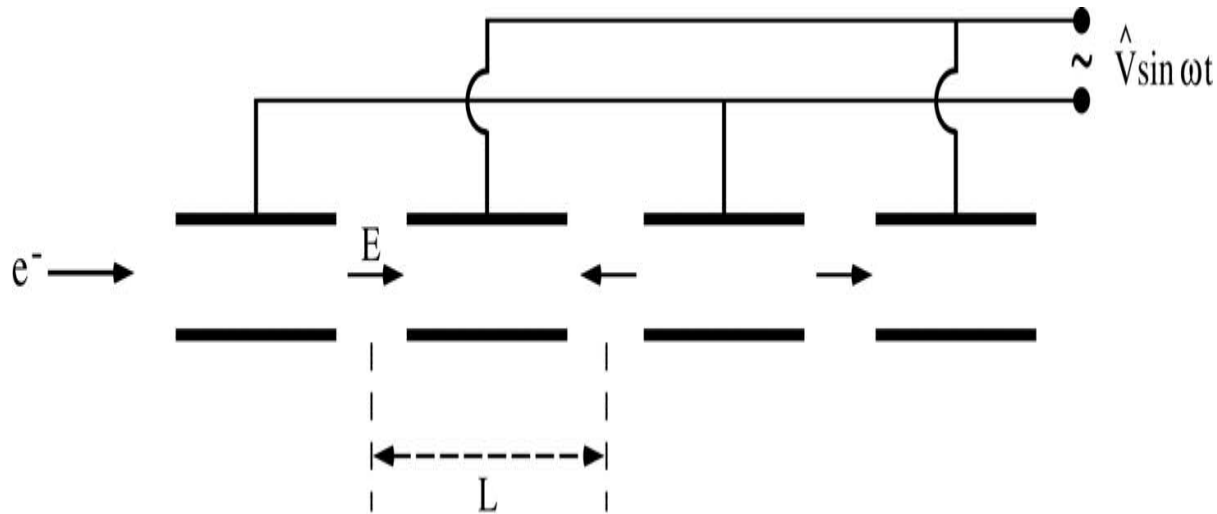

Cylindrical electrodes separated by gaps and fed by a RF generator, as shown on the Figure, lead to an alternating electric field polarity

Synchronism condition  $\longrightarrow L = v T/2$

( $v$  = particle velocity)

# Radio-Frequency Acceleration (2)

$L = vT/2$  ( $\pi$  mode)

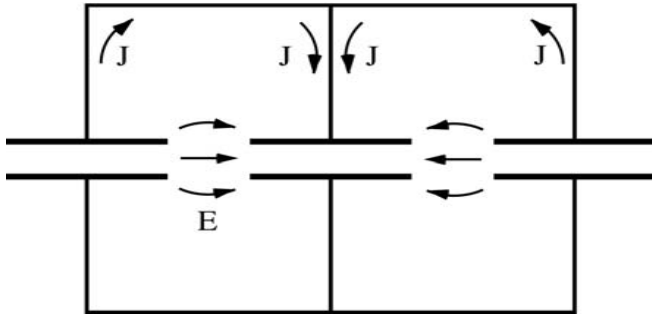

$L = vT$  ( $2\pi$  mode)

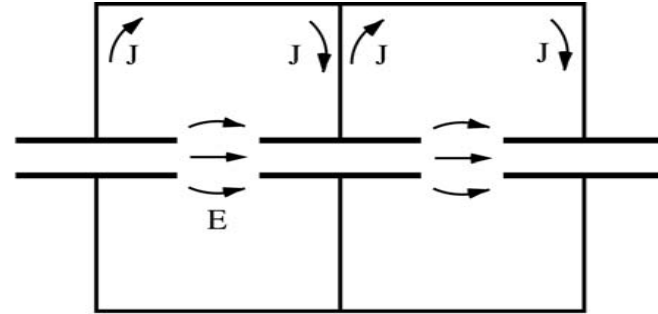

Single Gap

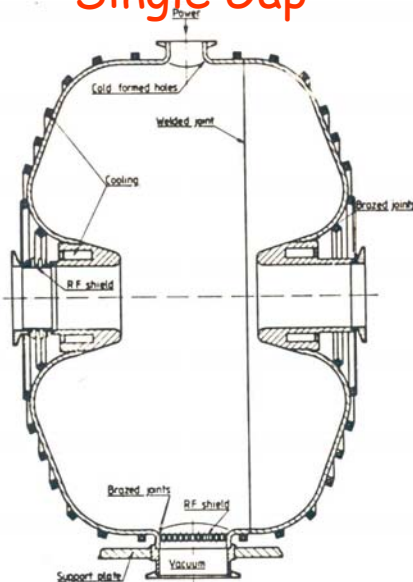

Multi-Gap

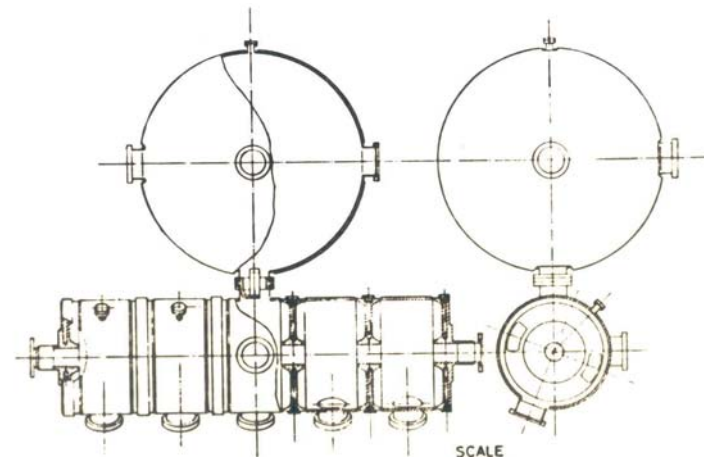

# Energy Gain

Newton-Lorentz Force

$$\frac{d\vec{p}}{dt} = e \vec{E}$$

Relativistic Dynamics

$$E^2 = E_0^2 + p^2 c^2 \quad \longrightarrow \quad dE = v dp$$

$$\frac{dE}{dz} = v \frac{dp}{dz} = \frac{dp}{dt} = e E_z$$

$$dE = dW = e E_z dz \quad \rightarrow \quad W = e \int E_z dz$$

RF Acceleration

$$E_z = \hat{E}_z \sin \omega_{RF} t = \hat{E}_z \sin \phi(t)$$

$$\int \hat{E}_z dz = \hat{V}$$

$$W = e \hat{V} \sin \phi$$

(neglecting transit time factor)



# Principle of Phase Stability

Let's consider a succession of accelerating gaps, operating in the  $2\pi$  mode, for which the synchronism condition is fulfilled for a phase  $\Phi_s$ .

For a  $2\pi$  mode, the electric field is the same in all gaps at any given time.

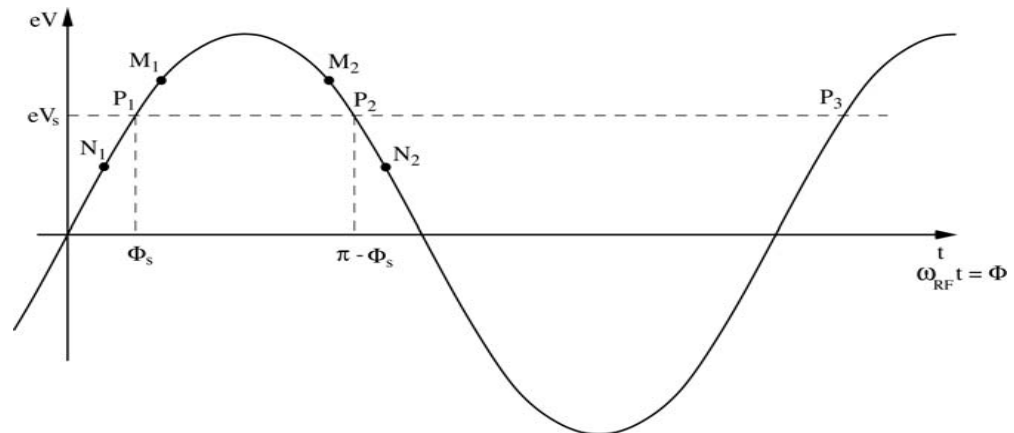

$$eV_s = e\hat{V} \sin\Phi_s$$

is the energy gain in one gap for the particle to reach the next gap with the same RF phase:  $P_1, P_2, \dots$  are fixed points.

If an increase in energy is transferred into an increase in velocity,  $M_1$  &  $N_1$  will move towards  $P_1$  (stable), while  $M_2$  &  $N_2$  will go away from  $P_2$  (unstable).

# A Consequence of Phase Stability

## Transverse Instability

Longitudinal phase stability means :  $\frac{\partial V}{\partial t} > 0 \Rightarrow \frac{\partial E_z}{\partial z} < 0$

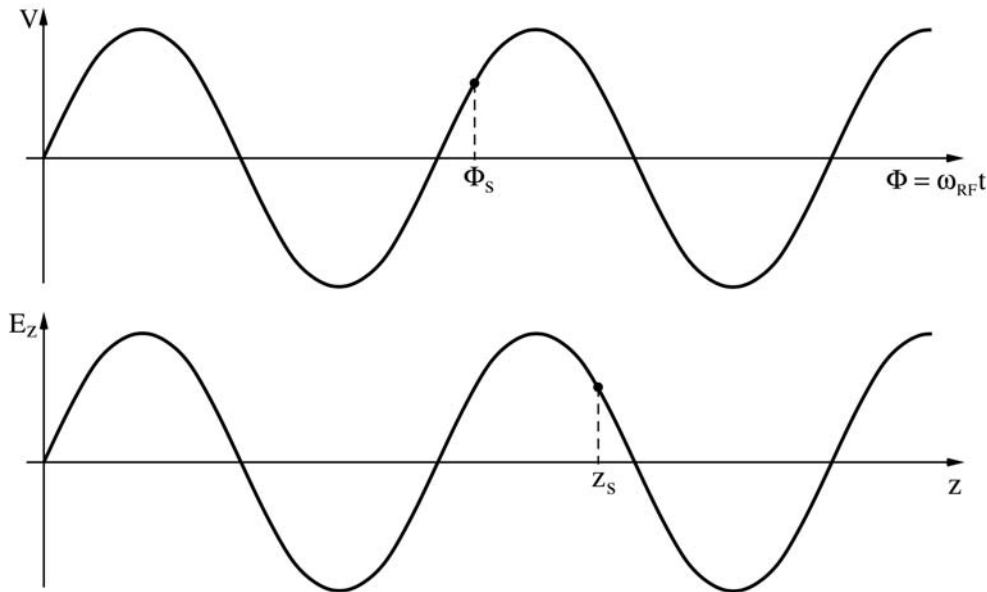

defocusing  
RF force

The divergence of the field is zero according to Maxwell :  $\nabla \cdot \vec{E} = 0 \Rightarrow \frac{\partial E_x}{\partial x} + \frac{\partial E_z}{\partial z} = 0 \Rightarrow \frac{\partial E_x}{\partial x} > 0$

External focusing (solenoid, quadrupole) is then necessary

# The Synchrotron

The synchrotron is a synchronous accelerator since there is a synchronous RF phase for which the energy gain fits the increase of the magnetic field at each turn. That implies the following operating conditions:

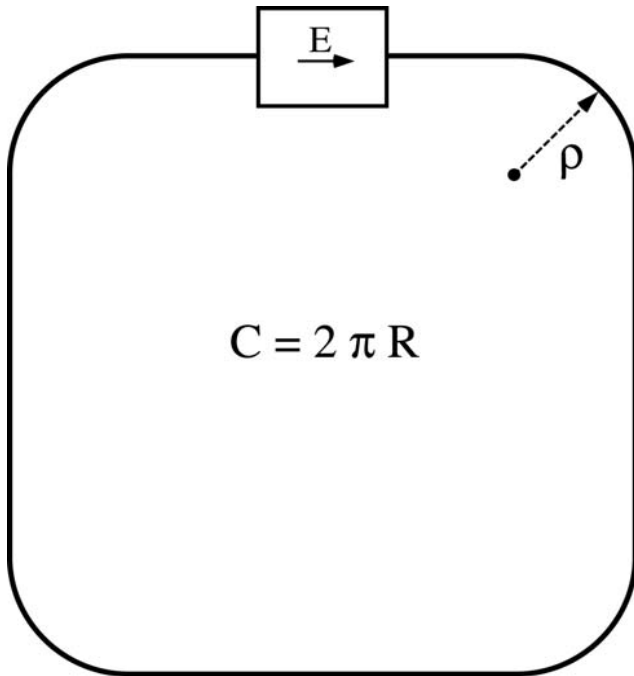

$$eV \sin \Phi \longrightarrow \text{Energy gain per turn}$$

$$\Phi = \Phi_s = cte \longrightarrow \text{Synchronous particle}$$

$$\omega_{RF} = h\omega_r \longrightarrow \text{RF synchronism}$$

$$\rho = cte \quad R = cte \longrightarrow \text{Constant orbit}$$

$$B\rho = \frac{P}{e} \Rightarrow B \longrightarrow \text{Variable magnetic field}$$

If  $v = c$ ,  $\omega_r$  hence  $\omega_{RF}$  remain constant (ultra-relativistic  $e^-$ )

## The Synchrotron (2)

Energy ramping is simply obtained by varying the B field:

$$p = eB\rho \quad \Rightarrow \quad \frac{dp}{dt} = e\rho B' \quad \Rightarrow \quad (\Delta p)_{turn} = e\rho B'T_r = \frac{2\pi e\rho RB'}{v}$$

Since:  $E^2 = E_0^2 + p^2 c^2 \quad \Rightarrow \quad \Delta E = v\Delta p$

$$(\Delta E)_{turn} = (\Delta W)_s = 2\pi e\rho RB' = e\hat{V}\sin\phi_s$$

- The number of stable synchronous particles is equal to the harmonic number  $h$ . They are equally spaced along the circumference.
- Each synchronous particle satisfies the relation  $p=eB\rho$ . They have the nominal energy and follow the nominal trajectory.

# Dispersion Effects in a Synchrotron

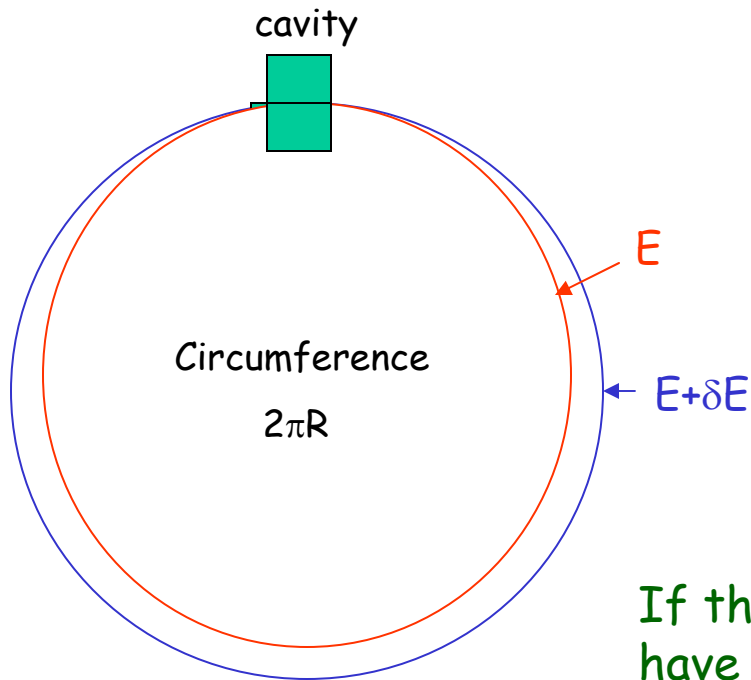

If a particle is slightly shifted in momentum it will have a different orbit:

$$\alpha = \frac{p}{R} \frac{dR}{dp}$$

This is the "momentum compaction" generated by the bending field.

If the particle is shifted in momentum it will have also a different velocity. As a result of both effects the revolution frequency changes:

$p$ =particle momentum

$R$ =synchrotron physical radius

$f_r$ =revolution frequency

$$\eta = \frac{p}{f_r} \frac{df_r}{dp}$$

# Dispersion Effects in a Synchrotron (2)

$$\alpha = \frac{p}{R} \frac{dR}{dp}$$

$$ds_0 = \rho d\theta$$

$$ds = (\rho + x) d\theta$$

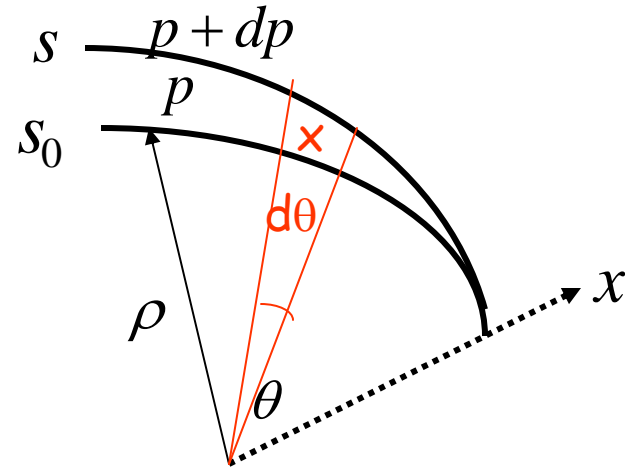

The elementary path difference from the two orbits is:

$$\frac{ds - ds_0}{ds_0} = \frac{dl}{ds_0} = \frac{x}{\rho}$$

leading to the total change in the circumference:

$$\int dl = 2\pi dR = \int \frac{x}{\rho} ds_0 = \frac{1}{\rho} \int_m x ds_0 \Rightarrow dR = \langle x \rangle_m$$

Since:  $x = D_x \frac{dp}{p}$

we get:

$$\alpha = \frac{\langle D_x \rangle_m}{R}$$

$\langle \rangle_m$  means that the average is considered over the bending magnet only

## Dispersion Effects in a Synchrotron (3)

$$\eta = \frac{p}{f_r} \frac{df_r}{dp}$$

$$f_r = \frac{\beta c}{2\pi R} \Rightarrow \frac{df_r}{f_r} = \frac{d\beta}{\beta} - \frac{dR}{R}$$

$$p = mv = \beta\gamma \frac{E_0}{c} \Rightarrow \frac{dp}{p} = \frac{d\beta}{\beta} + \frac{d(1-\beta^2)^{-\frac{1}{2}}}{(1-\beta^2)^{-\frac{1}{2}}} = (1-\beta^2)^{-1} \frac{d\beta}{\beta}$$

$$\frac{df_r}{f_r} = \left( \frac{1}{\gamma^2} - \alpha \right) \frac{dp}{p}$$



$$\eta = \frac{1}{\gamma^2} - \alpha$$

$\eta=0$  at the transition energy

$$\gamma_{tr} = \frac{1}{\sqrt{\alpha}}$$

# Phase Stability in a Synchrotron

From the definition of  $\eta$  it is clear that below transition an increase in energy is followed by a higher revolution frequency (increase in velocity dominates) while the reverse occurs above transition ( $v \approx c$  and longer path) where the momentum compaction (generally  $> 0$ ) dominates.

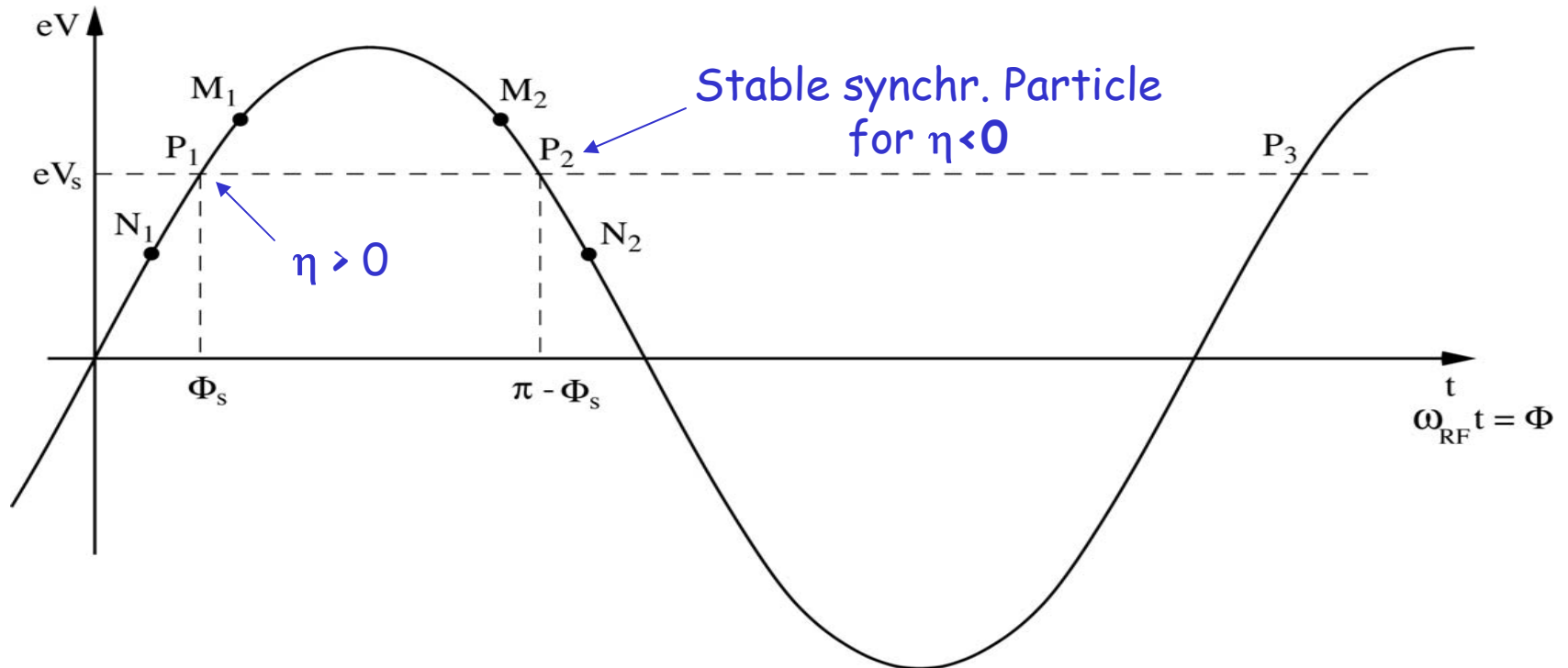



# Longitudinal Dynamics

It is also often called "synchrotron motion".

The RF acceleration process clearly emphasizes two coupled variables, the energy gained by the particle and the RF phase experienced by the same particle. Since there is a well defined synchronous particle which has always the same phase  $\phi_s$ , and the nominal energy  $E_s$ , it is sufficient to follow other particles with respect to that particle. So let's introduce the following reduced variables:

revolution frequency :  $\Delta f_r = f_r - f_{rs}$

particle RF phase :  $\Delta\phi = \phi - \phi_s$

particle momentum :  $\Delta p = p - p_s$

particle energy :  $\Delta E = E - E_s$

azimuth angle :  $\Delta\theta = \theta - \theta_s$

# First Energy-Phase Equation

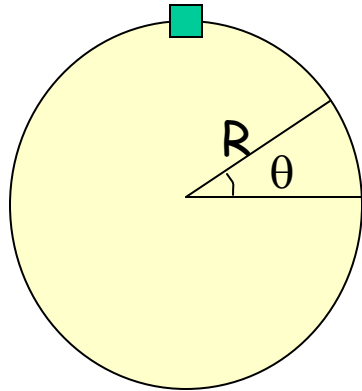

$$f_{RF} = hf_r \Rightarrow \Delta\phi = -h\Delta\theta \quad \text{with} \quad \theta = \int \omega_r dt$$

For a given particle with respect to the reference one:

$$\Delta\omega_r = \frac{d}{dt}(\Delta\theta) = -\frac{1}{h} \frac{d}{dt}(\Delta\phi) = -\frac{1}{h} \frac{d\phi}{dt}$$

Since:

$$\eta = \frac{p_s}{\omega_{rs}} \left( \frac{d\omega_r}{dp} \right)_s$$

and

$$E^2 = E_0^2 + p^2 c^2$$

$$\Delta E = v_s \Delta p = \omega_{rs} R_s \Delta p$$

one gets:

$$\frac{\Delta E}{\omega_{rs}} = -\frac{p_s R_s}{h \eta \omega_{rs}} \frac{d(\Delta\phi)}{dt} = -\frac{p_s R_s}{h \eta \omega_{rs}} \dot{\phi}$$

## Second Energy-Phase Equation

The rate of energy gained by a particle is:  $\frac{dE}{dt} = e\hat{V}\sin\phi \frac{\omega_r}{2\pi}$

The rate of relative energy gain with respect to the reference particle is then:

$$2\pi\Delta\left(\frac{\dot{E}}{\omega_r}\right) = e\hat{V}(\sin\phi - \sin\phi_s)$$

Expanding the left hand side to first order:

$$\Delta(\dot{E}T_r) \cong \dot{E}\Delta T_r + T_{rs}\Delta\dot{E} = \Delta E\dot{T}_r + T_{rs}\Delta\dot{E} = \frac{d}{dt}(T_{rs}\Delta E)$$

leads to the second energy-phase equation:

$$2\pi\frac{d}{dt}\left(\frac{\Delta E}{\omega_{rs}}\right) = e\hat{V}(\sin\phi - \sin\phi_s)$$

# Equations of Longitudinal Motion

$$\frac{\Delta E}{\omega_{rs}} = -\frac{p_s R_s}{h \eta \omega_{rs}} \frac{d(\Delta \phi)}{dt} = -\frac{p_s R_s}{h \eta \omega_{rs}} \dot{\phi}$$

$$2\pi \frac{d}{dt} \left( \frac{\Delta E}{\omega_{rs}} \right) = e \hat{V} (\sin \phi - \sin \phi_s)$$

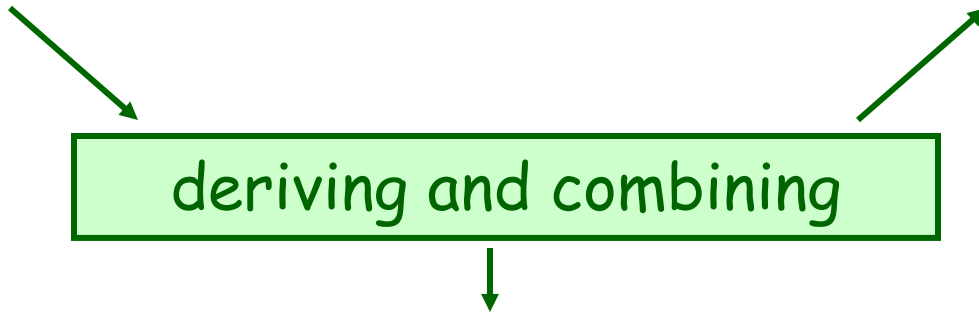

$$\frac{d}{dt} \left[ \frac{R_s p_s}{h \eta \omega_{rs}} \frac{d\phi}{dt} \right] + \frac{e \hat{V}}{2\pi} (\sin \phi - \sin \phi_s) = 0$$

This second order equation is non linear. Moreover the parameters within the bracket are in general slowly varying with time.....

# Hamiltonian of Longitudinal Motion

Introducing a new convenient variable,  $W$ , leads to the 1<sup>th</sup> order equations:

$$W = 2\pi \left( \frac{\Delta E}{\omega_{rs}} \right) = 2\pi R_s \Delta p$$



$$\frac{d\phi}{dt} = -\frac{1}{2\pi} \frac{h\eta\omega_{rs}}{p_s R_s} W$$

$$\frac{dW}{dt} = e\hat{V}(\sin\phi - \sin\phi_s)$$

These equations of motion derive from a hamiltonian  $H(\phi, W, t)$ :

$$\frac{d\phi}{dt} = \frac{\partial H}{\partial W}$$

$$\frac{dW}{dt} = -\frac{\partial H}{\partial \phi}$$

$$H(\phi, W, t) = e\hat{V}[\cos\phi - \cos\phi_s + (\phi - \phi_s)\sin\phi_s] - \frac{1}{4\pi} \frac{h\eta\omega_{rs}}{R_s p_s} W^2$$

# Small Amplitude Oscillations

Let's assume constant parameters  $R_s, p_s, \omega_s$  and  $\eta$ :

$$\ddot{\phi} + \frac{\Omega_s^2}{\cos\phi_s} (\sin\phi - \sin\phi_s) = 0$$

with

$$\Omega_s^2 = \frac{h\eta\omega_{rs}e\hat{V}\cos\phi_s}{2\pi R_s p_s}$$

Consider now small phase deviations from the reference particle:

$$\sin\phi - \sin\phi_s = \sin(\phi_s + \Delta\phi) - \sin\phi_s \cong \cos\phi_s \Delta\phi \quad (\text{for small } \Delta\phi)$$

and the corresponding linearized motion reduces to a harmonic oscillation:

$$\ddot{\phi} + \Omega_s^2 \Delta\phi = 0$$

stable for  $\Omega_s^2 > 0$  and  $\Omega_s$  real

$$\gamma < \gamma_{tr}$$

$$\eta > 0$$

$$0 < \phi_s < \pi/2$$

$$\sin\phi_s > 0$$

$$\gamma > \gamma_{tr}$$

$$\eta < 0$$

$$\pi/2 < \phi_s < \pi$$

$$\sin\phi_s > 0$$

# Large Amplitude Oscillations

For larger phase (or energy) deviations from the reference the second order differential equation is non-linear:

$$\ddot{\phi} + \frac{\Omega_s^2}{\cos \phi_s} (\sin \phi - \sin \phi_s) = 0 \quad (\Omega_s \text{ as previously defined})$$

Multiplying by  $\dot{\phi}$  and integrating gives an invariant of the motion:

$$\frac{\dot{\phi}^2}{2} - \frac{\Omega_s^2}{\cos \phi_s} (\cos \phi + \phi \sin \phi_s) = I$$

which for small amplitudes reduces to:

$$\frac{\dot{\phi}^2}{2} + \Omega_s^2 \frac{(\Delta\phi)^2}{2} = I \quad (\text{the variable is } \Delta\phi \text{ and } \phi_s \text{ is constant})$$

Similar equations exist for the second variable :  $\Delta E \propto d\phi/dt$

## Large Amplitude Oscillations (2)

When  $\phi$  reaches  $\pi - \phi_s$  the force goes to zero and beyond it becomes non restoring. Hence  $\pi - \phi_s$  is an extreme amplitude for a stable motion which in the phase space  $(\frac{\dot{\phi}}{\Omega_s}, \Delta\phi)$  is shown as closed trajectories.

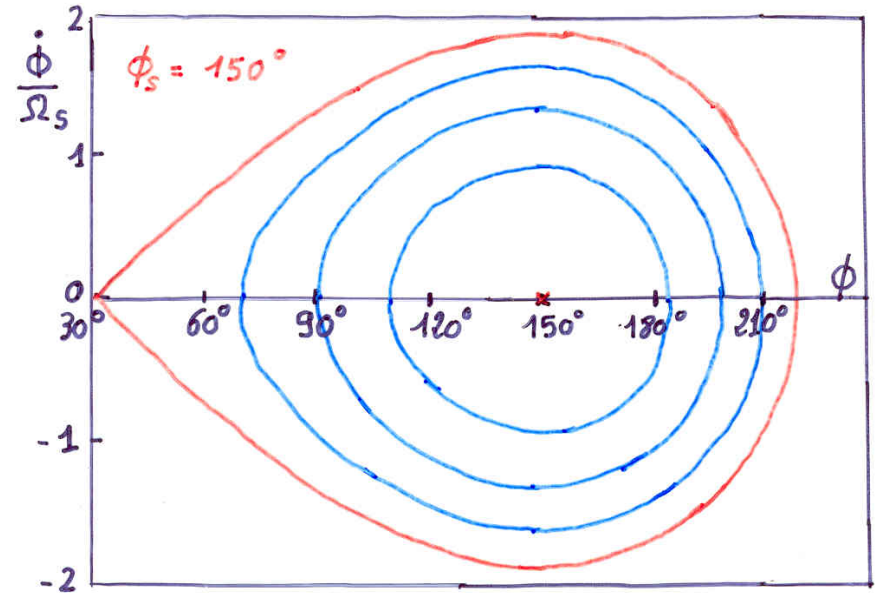

**Equation of the separatrix:**

$$\frac{\dot{\phi}^2}{2} - \frac{\Omega_s^2}{\cos \phi_s} (\cos \phi + \phi \sin \phi_s) = -\frac{\Omega_s^2}{\cos \phi_s} (\cos(\pi - \phi_s) + (\pi - \phi_s) \sin \phi_s)$$

**Second value  $\phi_m$  where the separatrix crosses the horizontal axis:**

$$\cos \phi_m + \phi_m \sin \phi_s = \cos(\pi - \phi_s) + (\pi - \phi_s) \sin \phi_s$$



# Energy Acceptance

From the equation of motion it is seen that  $\dot{\phi}$  reaches an extremum when  $\ddot{\phi} = 0$ , hence corresponding to  $\phi = \phi_s$ .

Introducing this value into the equation of the separatrix gives:

$$\dot{\phi}_{\max}^2 = 2\Omega_s^2 \{ 2 + (2\phi_s - \pi) \tan \phi_s \}$$

That translates into an acceptance in energy:

$$\left( \frac{\Delta E}{E_s} \right)_{\max} = \mp \beta \left\{ -\frac{e\hat{V}}{\pi h \eta E_s} G(\phi_s) \right\}^{\frac{1}{2}}$$

$$G(\phi_s) = [2\cos\phi_s + (2\phi_s - \pi)\sin\phi_s]$$

This “RF acceptance” depends strongly on  $\phi_s$  and plays an important role for the electron capture at injection, and the stored beam lifetime.

# RF Acceptance versus Synchronous Phase

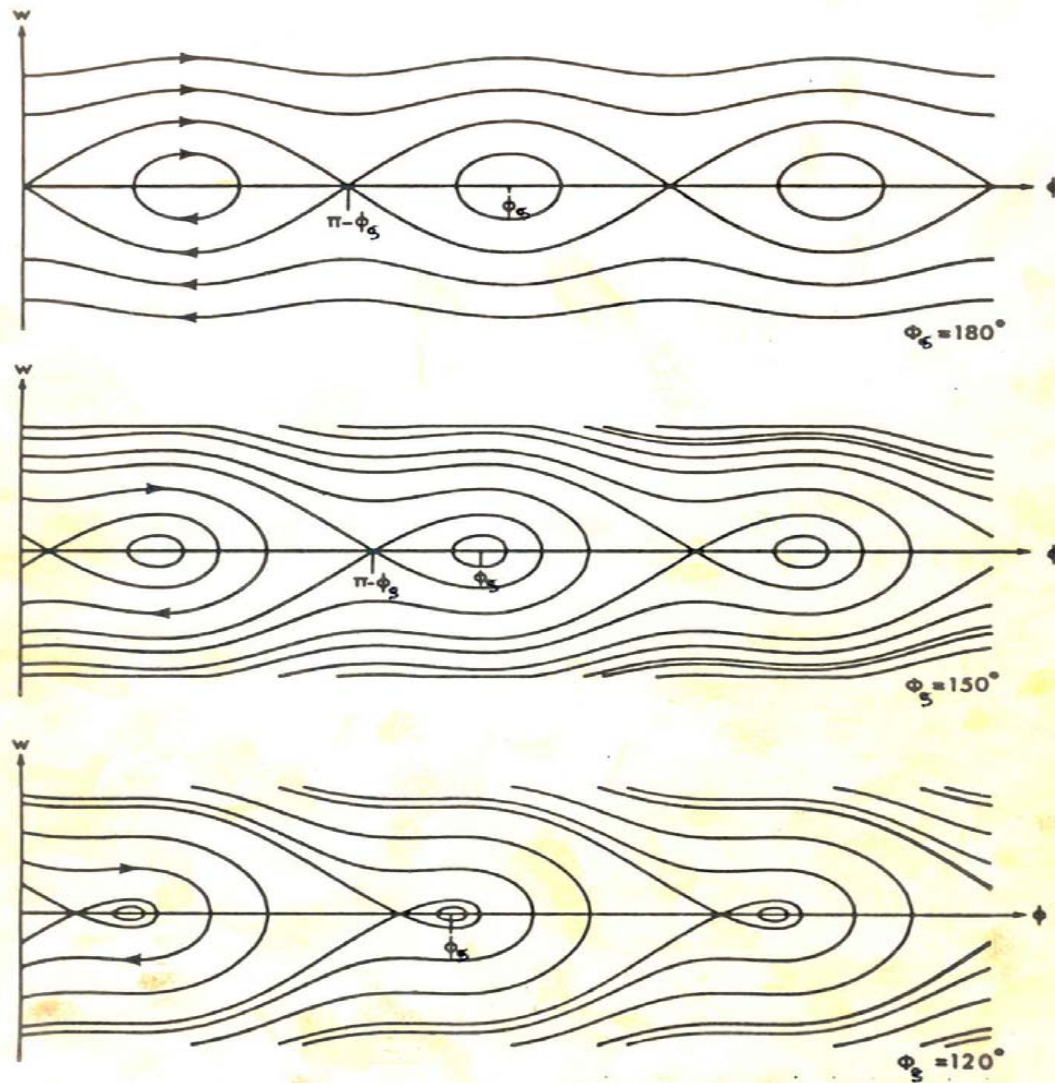

As the synchronous phase gets closer to  $90^\circ$  the area of stable motion (closed trajectories) gets smaller. These areas are often called "BUCKET".

The number of circulating buckets is equal to "h".

The phase extension of the bucket is maximum for  $\phi_s = 180^\circ$  (or  $0^\circ$ ) which correspond to no acceleration. The RF acceptance increases with the RF voltage.

# Potential Energy Function

The longitudinal motion is produced by a force that can be derived from a scalar potential:

$$\frac{d^2\phi}{dt^2} = F(\phi) \qquad F(\phi) = -\frac{\partial U}{\partial \phi}$$

$$U = -\int_0^\phi F(\phi) d\phi = -\frac{\Omega_s^2}{\cos\phi_s} (\cos\phi + \phi \sin\phi_s) - F_0$$

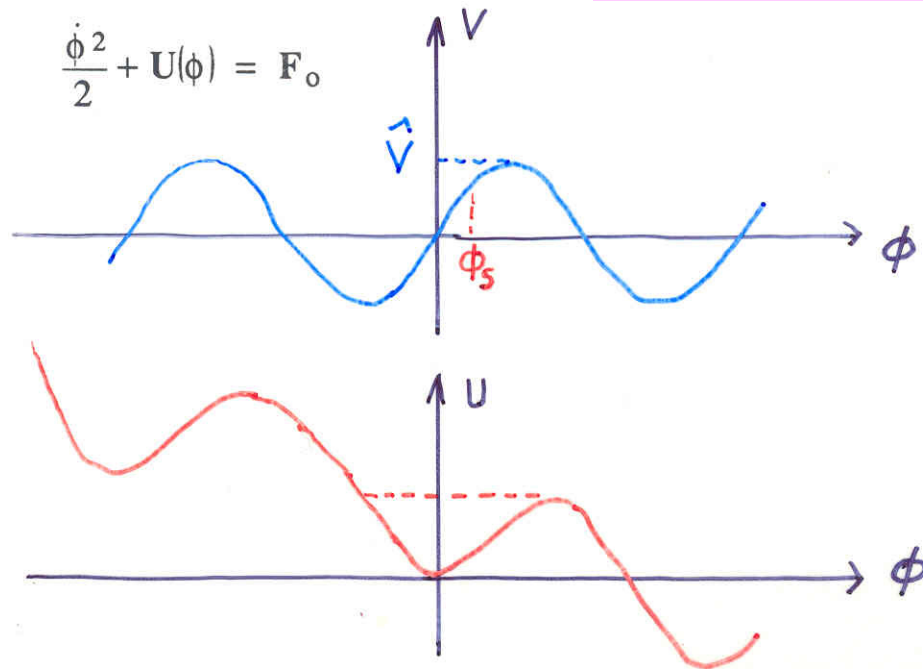

The sum of the potential energy and kinetic energy is constant and by analogy represents the total energy of a non-dissipative system.

# From Synchrotron to Linac

In the linac there is no bending magnets, hence there is no dispersion effects on the orbit and  $\alpha=0$  and  $\eta=1/\gamma^2$ .

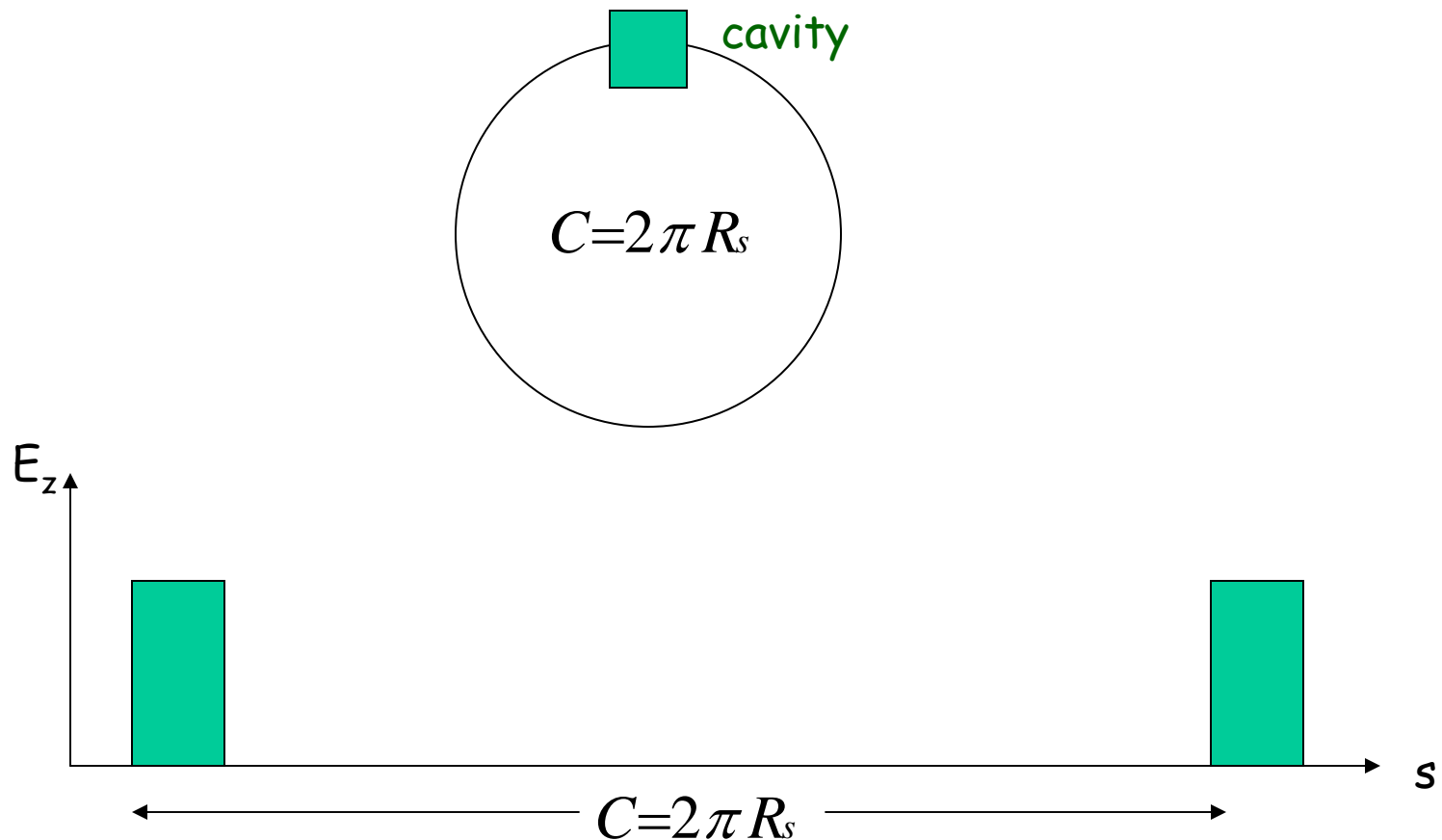

## From Synchrotron to Linac (2)

In the linac there is no bending magnets, hence there is no dispersion effects on the orbit and  $\alpha=0$  and  $\eta=1/\gamma^2$ .

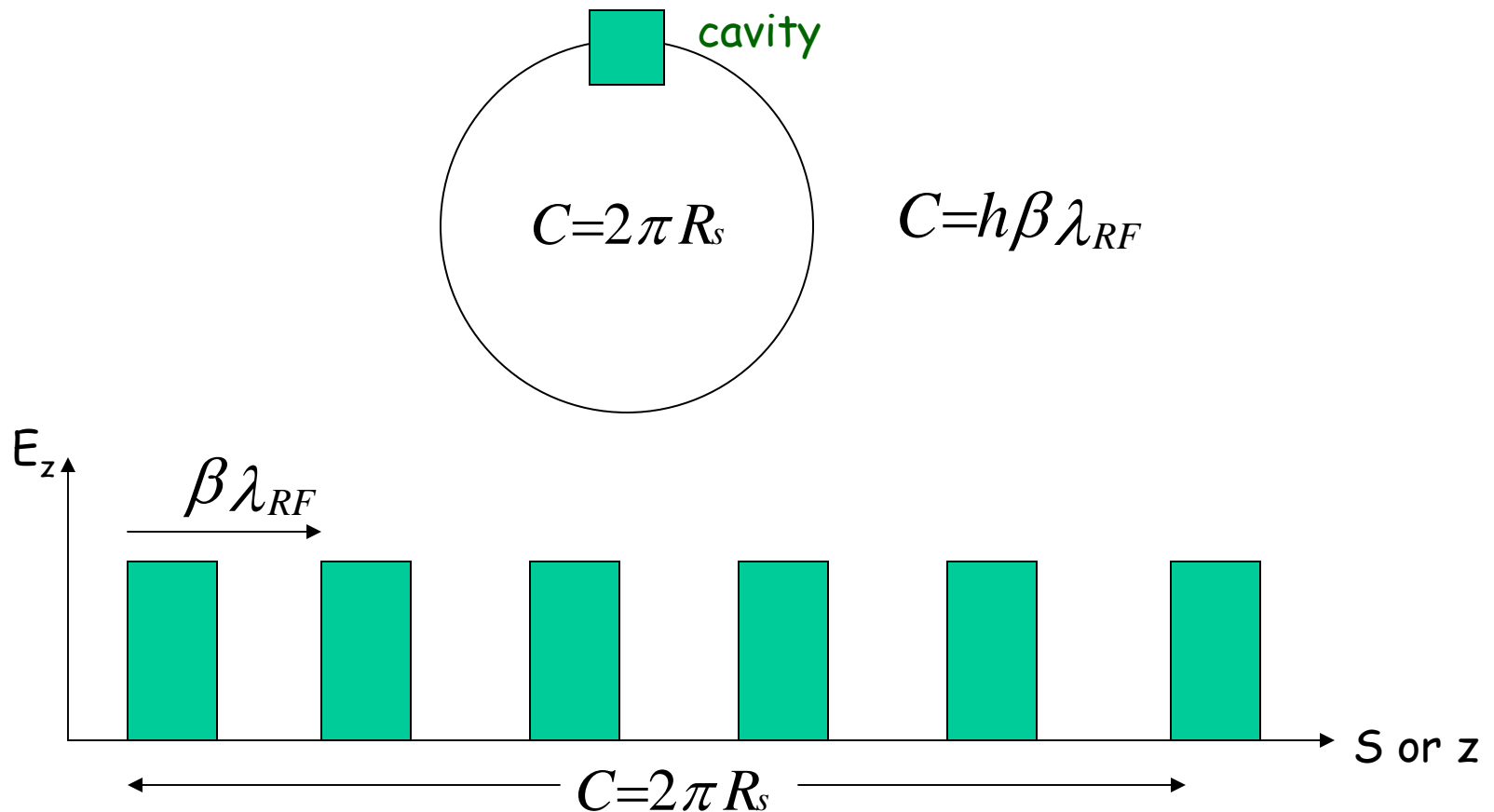

## From Synchrotron to Linac (3)

Since in the linac  $\alpha=0$  and  $\eta=1/\gamma^2$ , the longitudinal frequency becomes:

$$\Omega_s^2 = \frac{h\gamma^{-2} \omega_{rs} e \hat{V} \cos \phi_s}{2\pi R_s p_s}$$

Moreover one has:

$$h\omega_s = \omega_{RF} \quad \hat{V} = 2\pi R_s E_0 \quad p_s = \gamma m_0 v_s$$

leading to:

$$\Omega_s^2 = \frac{e E_0 \omega_{RF} \cos \phi_s}{m_0 \gamma^3 v_s^3}$$

$$\gamma \rightarrow \infty \quad \Omega_s \rightarrow 0$$

Since in a linac the independent variable is  $z$  rather than  $t$  one gets:

$$\left( \frac{2\pi}{\lambda_s} \right)^2 = \frac{e E_0 \omega_{RF} \cos \phi_s}{m_0 \gamma^3 v_s^3}$$

# Adiabatic Damping

Though there are many physical processes that can damp the longitudinal oscillation amplitudes, one is directly generated by the acceleration process itself. It will happen in the synchrotron, even ultra-relativistic, when ramping the energy but not in the ultra-relativistic electron linac which does not show any oscillation.

As a matter of fact, when  $E_s$  varies with time, one needs to be more careful in combining the two first order energy-phase equations in one second order equation:

The damping coefficient is proportional to the rate of energy variation and from the definition of  $\Omega_s$  one has:

$$\frac{\dot{E}_s}{E_s} = -2 \frac{\dot{\Omega}_s}{\Omega_s}$$

$$\frac{d}{dt} (E_s \dot{\phi}) = -\Omega_s^2 E_s \Delta \phi$$

$$E_s \ddot{\phi} + \dot{E}_s \dot{\phi} + \Omega_s^2 E_s \Delta \phi = 0$$

$$\ddot{\phi} + \frac{\dot{E}_s}{E_s} \dot{\phi} + \Omega_s^2 (E_s) \Delta \phi = 0$$

## Adiabatic Damping (2)

So far it was assumed that parameters related to the acceleration process were constant. Let's consider now that they vary slowly with respect to the period of longitudinal oscillation (adiabaticity).

For small amplitude oscillations the hamiltonian reduces to:

$$H(\phi, W, t) \cong -\frac{e\hat{V}}{2} \cos\phi_s (\Delta\phi)^2 - \frac{1}{4\pi} \frac{h\eta\omega_{rs}}{R_s p_s} W^2 \quad \text{with} \quad \begin{aligned} W &= \hat{W} \cos \Omega_s t \\ \Delta\phi &= (\Delta\hat{\phi}) \sin \Omega_s t \end{aligned}$$

Under adiabatic conditions the Boltzman-Ehrenfest theorem states that the action integral remains constant:

$$I = \oint W d\phi = \text{const.} \quad (W, \phi \text{ are canonical variables})$$

Since:

$$\frac{d\phi}{dt} = \frac{\partial H}{\partial W} = -\frac{1}{2\pi} \frac{h\eta\omega_{rs}}{R_s p_s} W$$

the action integral becomes:

$$I = \oint W \frac{d\phi}{dt} dt = -\frac{1}{2\pi} \frac{h\eta\omega_{rs}}{R_s p_s} \oint W^2 dt$$



## Adiabatic Damping (3)

Previous integral over one period:

$$\oint W^2 dt = \pi \frac{\hat{W}^2}{\Omega_s}$$

leads to:

$$I = -\frac{h\eta\omega_{rs}}{2R_s p_s} \frac{\hat{W}^2}{\Omega_s} = \text{const.}$$

From the quadratic form of the hamiltonian one gets the relation:

$$\hat{W} = \frac{2\pi p_s R_s \Omega_s}{h\eta\omega_{rs}} \Delta\hat{\phi}$$

Finally under adiabatic conditions the long term evolution of the oscillation amplitudes is shown to be:

$$\Delta\hat{\phi} \propto \left[ \frac{\eta}{E_s R_s^2 \hat{V} \cos\phi_s} \right]^{1/4} \propto E_s^{-1/4}$$

$$\hat{W} \text{ or } \Delta\hat{E} \propto E_s^{1/4}$$

$$\hat{W} \cdot \Delta\hat{\phi} = \text{invariant}$$

# Dynamics in the Vicinity of Transition Energy

Introducing in the previous expressions:  $\eta = \frac{1}{\gamma^2} - \alpha = \gamma^{-2} - \gamma_t^{-2}$

one gets:

$$\Delta\hat{\phi} \propto \left\{ \frac{1}{\hat{V}|\cos\phi_s|} \frac{|\gamma^{-2} - \gamma_t^{-2}|}{\gamma} \right\}^{1/4}$$

$$\Delta\hat{E} \propto \left\{ \frac{1}{\hat{V}|\cos\phi_s|} \frac{|\gamma^{-2} - \gamma_t^{-2}|}{\gamma} \right\}^{-1/4}$$

$$\Omega_s \propto \left\{ \hat{V}|\cos\phi_s| \frac{|\gamma^{-2} - \gamma_t^{-2}|}{\gamma} \right\}^{1/2}$$

# Dynamics in the Vicinity of Transition Energy (2)

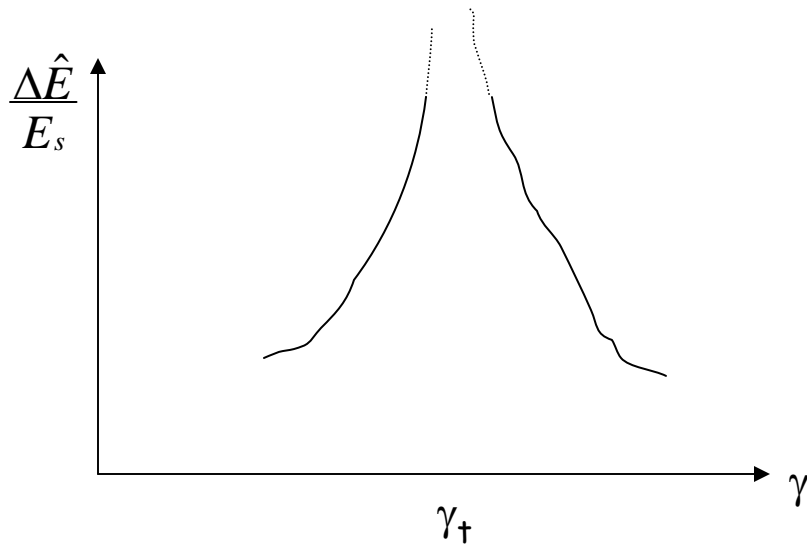
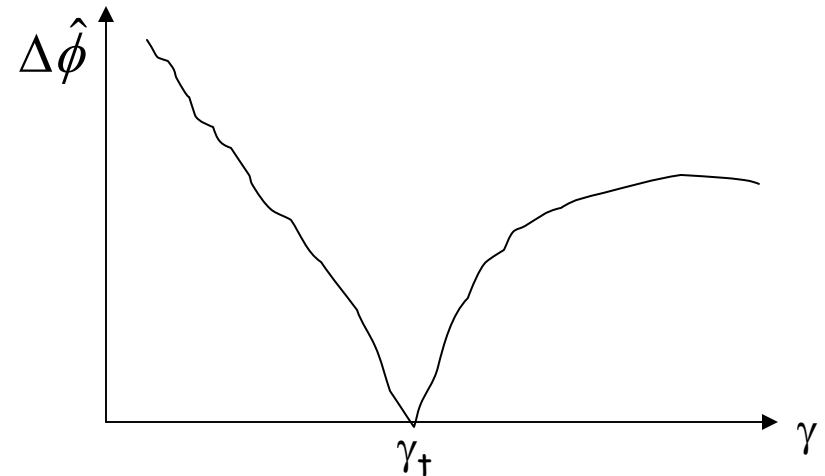
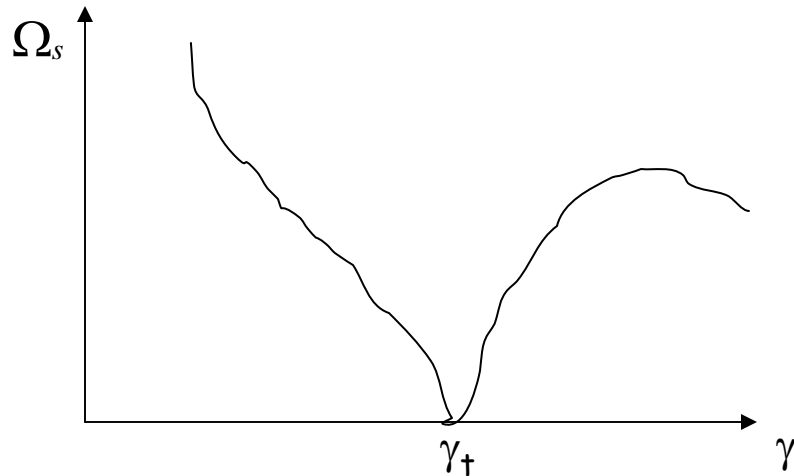

In fact close to transition, adiabatic solution are not valid since parameters change too fast. A proper treatment would show that:

$\Delta\phi$  will not go to zero

$\Delta E$  will not go to infinity

# Stationnary Bucket

This is the case  $\sin\phi_s=0$  (no acceleration) which means  $\phi_s=0$  or  $\pi$ . The equation of the separatrix for  $\phi_s = \pi$  (above transition) becomes:

$$\frac{\dot{\phi}^2}{2} + \Omega_s^2 \cos \phi = \Omega_s^2$$

$$\frac{\dot{\phi}^2}{2} = 2\Omega_s^2 \sin^2 \frac{\phi}{2}$$

Replacing the phase derivative by the canonical variable  $W$ :

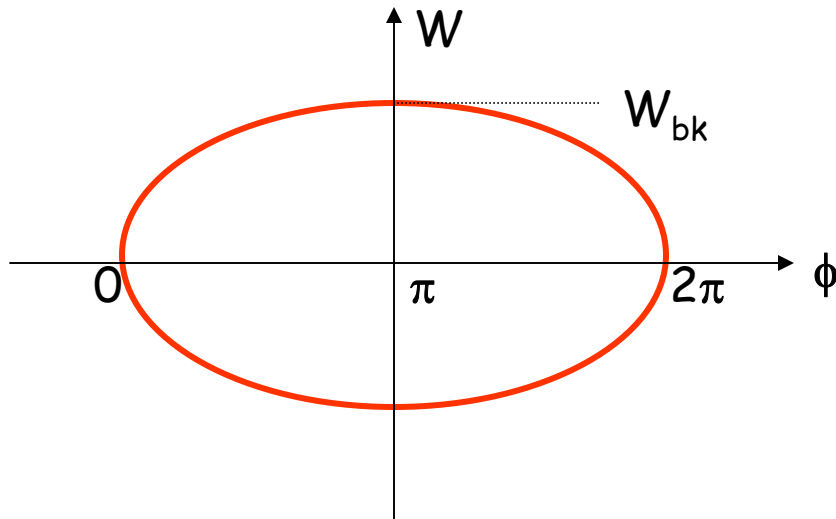

$$W = 2\pi \frac{\Delta E}{\omega_{rs}} = -2\pi \frac{p_s R_s}{h \eta \omega_{rs}} \dot{\phi}$$

and introducing the expression for  $\Omega_s$  leads to the following equation for the separatrix:

$$W = \pm 2 \frac{C}{c} \sqrt{\frac{-e \hat{V} E_s}{2\pi h \eta}} \sin \frac{\phi}{2}$$

with  $C=2\pi R_s$

## Stationnary Bucket (2)

Setting  $\phi=\pi$  in the previous equation gives the height of the bucket:

$$W_{bk} = 2 \frac{C}{c} \sqrt{\frac{-e\hat{V} E_s}{2\pi h \eta}}$$

The area of the bucket is:

$$A_{bk} = 2 \int_0^{2\pi} W d\phi$$

Since:

$$\int_0^{2\pi} \sin \frac{\phi}{2} d\phi = 4$$

one gets:

$$A_{bk} = 16 \frac{C}{c} \sqrt{\frac{-e\hat{V} E_s}{2\pi h \eta}}$$



$$W_{bk} = \frac{A_{bk}}{8}$$

# Bunch Matching into a Stationnary Bucket

A particle trajectory inside the separatrix is described by the equation:

$$\frac{\dot{\phi}^2}{2} - \frac{\Omega_s^2}{\cos\phi_s} (\cos\phi + \phi \sin\phi_s) = I \quad \xrightarrow{\phi_s = \pi} \quad \frac{\dot{\phi}^2}{2} + \Omega_s^2 \cos\phi = I$$

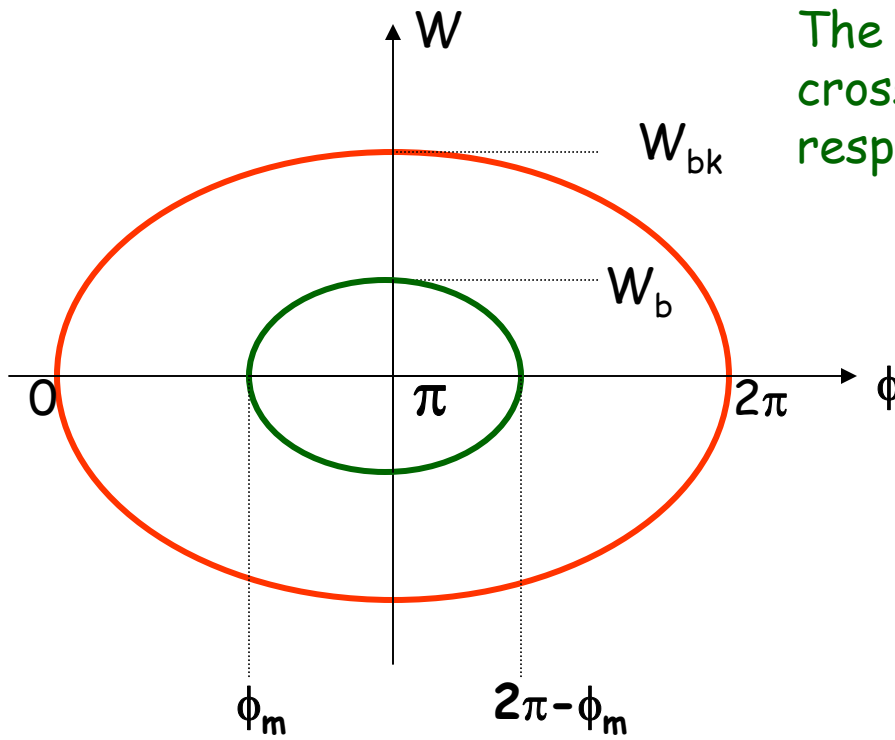

The points where the trajectory crosses the axis are symmetric with respect to  $\phi_s = \pi$

$$\frac{\dot{\phi}^2}{2} + \Omega_s^2 \cos\phi = \Omega_s^2 \cos\phi_m$$

$$\dot{\phi} = \pm \Omega_s \sqrt{2(\cos\phi_m - \cos\phi)}$$

$$W = \pm \frac{A_{bk}}{8} \sqrt{\cos^2 \frac{\phi_m}{2} - \cos^2 \frac{\phi}{2}}$$

## Bunch Matching into a Stationnary Bucket (2)

Setting  $\phi = \pi$  in the previous formula allows to calculate the bunch height:

$$W_b = \frac{A_{bk}}{8} \cos \frac{\phi_m}{2}$$

or:

$$W_b = W_{bk} \cos \frac{\phi_m}{2} \longrightarrow \left( \frac{\Delta E}{E_s} \right)_b = \left( \frac{\Delta E}{E_s} \right)_{RF} \cos \frac{\phi_m}{2}$$

This formula shows that for a given bunch energy spread the proper matching of a shorter bunch will require a bigger RF acceptance, hence a higher voltage ( short bunch means  $\phi_m$  close to  $\pi$  ).

# Effect of a Mismatch

Starting with an injected bunch with short length and large energy spread, after a quarter of synchrotron period the bunch rotation shows a longer bunch with a smaller energy spread.

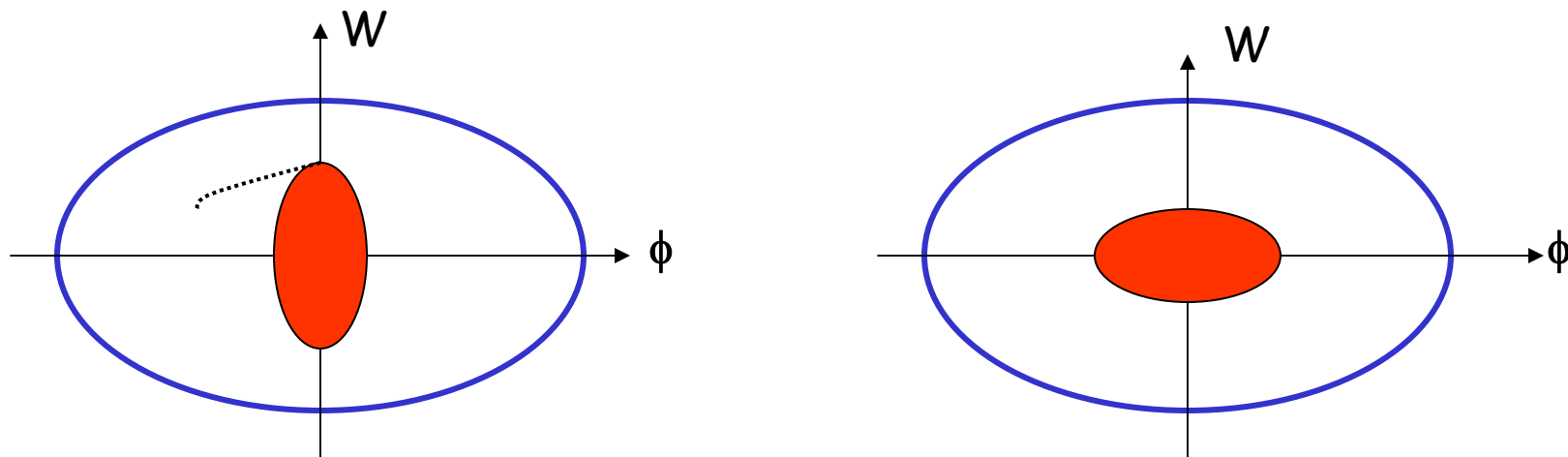

For small oscillation amplitudes the equation of the ellipse reduces to:

$$W = \frac{A_{bk}}{16} \sqrt{(\Delta\phi)_m^2 - (\Delta\phi)^2} \longrightarrow \left( \frac{16W}{A_{bk}(\Delta\phi)_m} \right)^2 + \left( \frac{\Delta\phi}{(\Delta\phi)_m} \right)^2 = 1$$

Ellipse area is called longitudinal emittance

$$A_b = \frac{\pi}{16} A_{bk} (\Delta\phi)_m^2$$



# Capture of a Debunched Beam with Adiabatic Turn-On

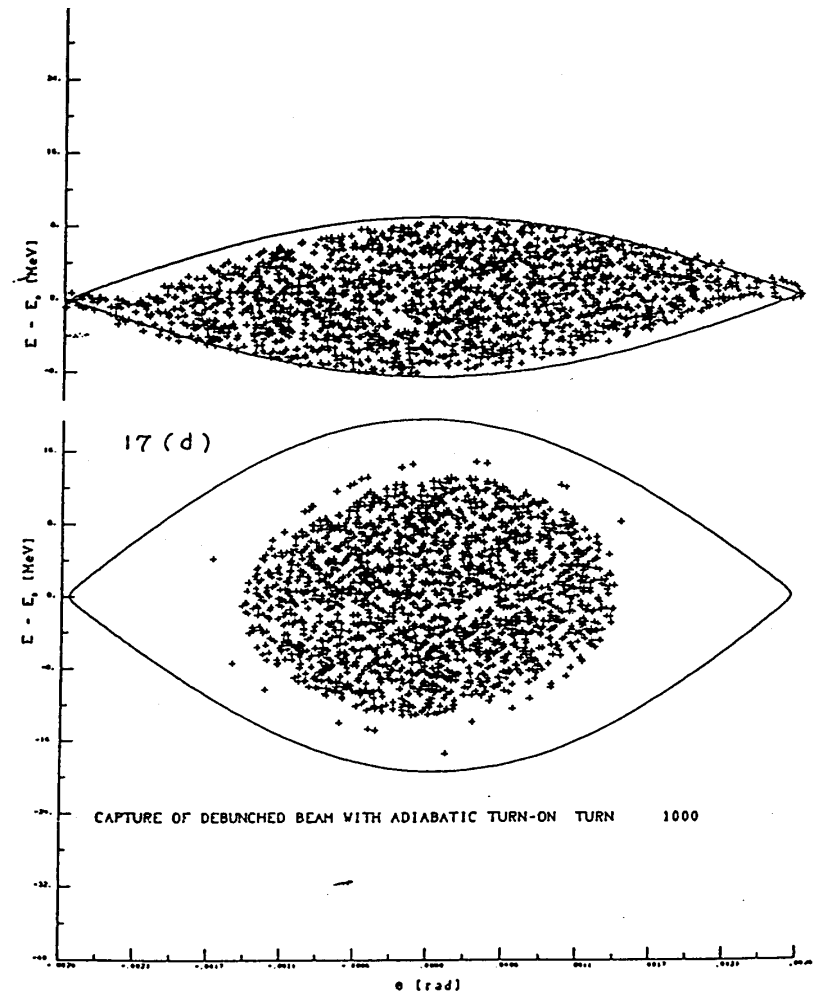
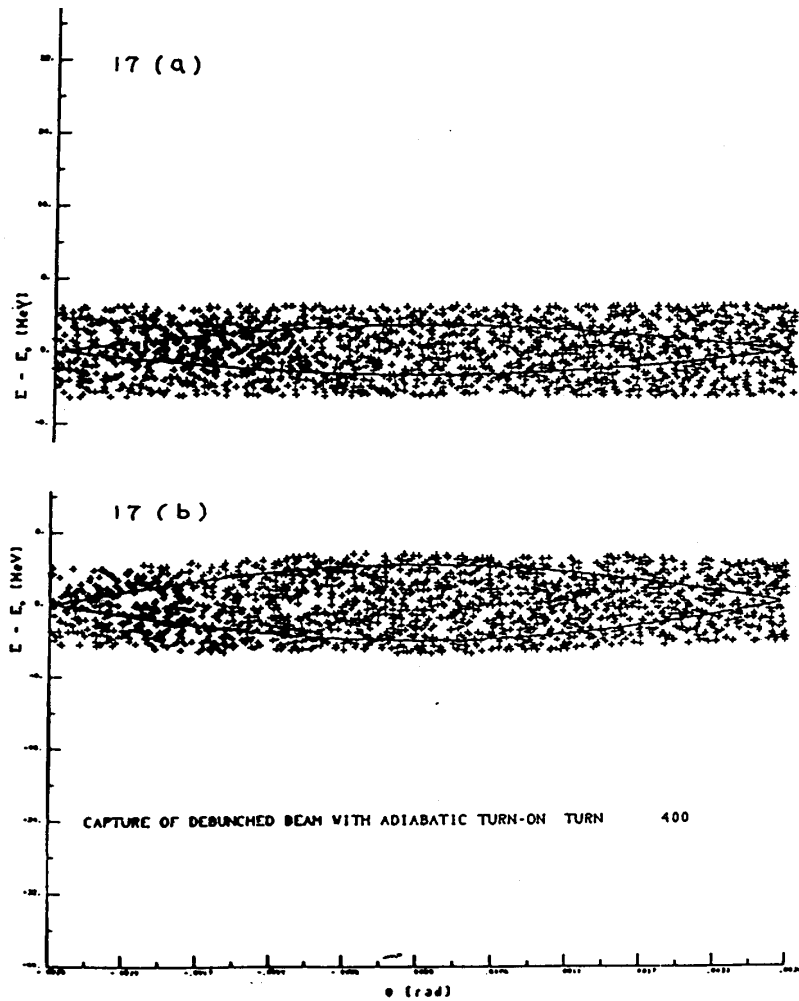

# Capture of a Debunched Beam with Fast Turn-On

