

# Beam Transfer Devices: Septa & Kickers

M.J. Barnes  
CERN TE/ABT

## Acknowledgements:

J. Borburgh, M. Hourican, T. Masson, J-M Cravero,  
L. Ducimetière, T. Fowler, V. Senaj, L. Sermeus,  
B. Goddard, M. Gyr, J. Uythoven

06/11/2013

CAS: Septa & Kickers. M.J. Barnes.

1

## Injection, Extraction and Transfer

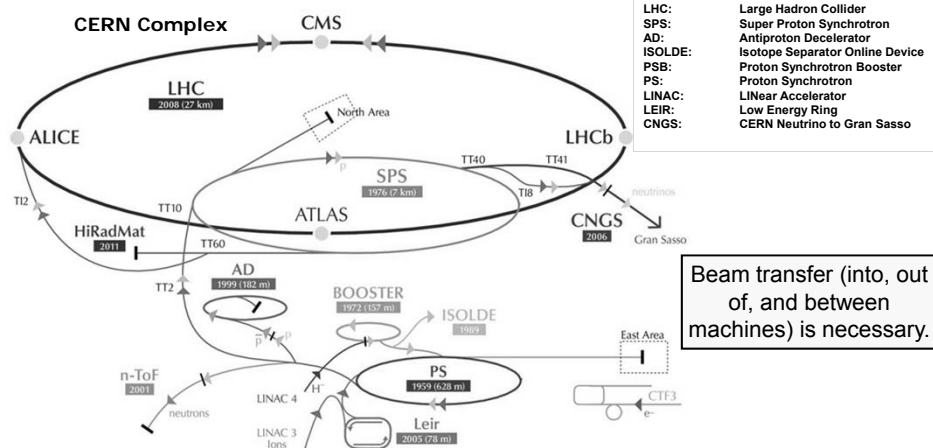

- An accelerator stage has limited dynamic range;
- A chain of stages is needed to reach high energy;
- Periodic re-filling of storage (collider) rings, such as LHC.

06/11/2013

CAS: Septa & Kickers. M.J. Barnes.

2

# Beam Transfer

- Beam transfer into and out of rings is required;
- A combination of septa and kickers are frequently used – both are needed;
- Septa have two vacuum chambers. Kickers have a single vacuum chamber;
- Septa can be electrostatic or magnetic;
- Magnetic septa provide slower field rise/fall times (possibly DC), but stronger field, than kicker magnets;
- Kicker magnets provide fast field rise/fall times, but relatively weak fields.

06/11/2013

CAS: Septa & Kickers. M.J. Barnes.

3

## Example Parameters for Septa and Kickers in the CERN Complex

Septum Location	Beam momentum (GeV/c)	Gap Height (mm)	Max. Current (kA)	Magnetic Flux Density (T)	Deflection (mrad)
LEIR/AD/CTF (13 systems)	Various	25 to 55	1 DC to 40 pulsed	0.5 to 1.6	up to 130
PS Booster (6 systems)	1.4	25 to 50	28 pulsed	0.1 to 0.6	up to 80
PS complex (8 systems)	26	20 to 40	2.5 DC to 33 pulsed	0.2 to 1.2	up to 55
SPS Ext.	450	20	24	1.5	2.25

Kicker Location	Beam momentum (GeV/c)	# Magnets	Gap Height [V <sub>ap</sub> ] (mm)	Current (kA)	Impedance (Ω)	Rise Time (ns)	Total Deflection (mrad)
CTF3	0.2	4	40	0.056	50	~4	1.2
PS Inj.	2.14	4	53	1.52	26.3	42	4.2
SPS Inj.	13/26	16	54 to 61	1.47/1.96	16.67/12.5	115/200	3.92
SPS Ext. (MKE4)	450	5	32 to 35	2.56	10	1100	0.48
LHC Inj.	450	4	54	5.12	5	900	0.82
LHC Abort	450 to 7000	15	73	1.3 to 18.5	1.5 (not T-line)	2700	0.275

06/11/2013

CAS: Septa & Kickers. M.J. Barnes.

4

# Lorentz Force

The Lorentz force is the force on a point charge due to electromagnetic fields. It is given by the following equation in terms of the electric and magnetic fields:

$$F = q \left[ E + (v \times B) \right]$$

- $F$  is the force (in Newton) – vector quantity;
- $E$  is the electric field (in volts per meter) – vector quantity;
- $B$  is the magnetic field (in Tesla) – vector quantity;
- $q$  is the electric charge of the particle (in Coulomb)
- $v$  is the instantaneous velocity of the particle (in meters per second) – vector quantity;
- $\times$  is the vector cross product

06/11/2013

CAS: Septa & Kickers. M.J. Barnes.

5

## Example of Deflection by Force in a Magnetic Field

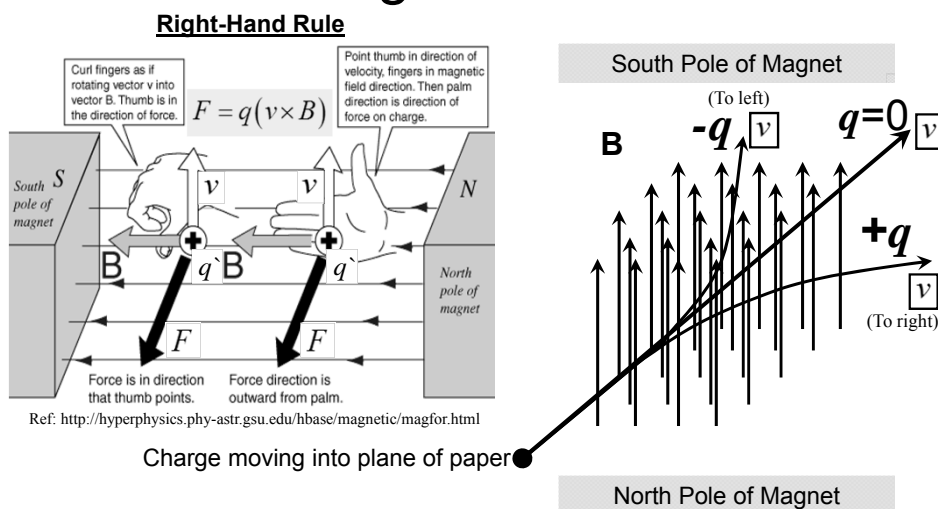

06/11/2013

CAS: Septa & Kickers. M.J. Barnes.

6

## Beam Deflection due to a Magnetic Field

$$\theta_{B,x} = \left[ \frac{0.3}{p} \right] \cdot \int_{z_0}^{z_1} |B_y| dz = \left[ \frac{0.3 \cdot l_{eff}}{p} \right] \cdot |B_y|$$

Where:

- $B$  is magnetic flux density (T);
- $p$  is beam momentum (GeV/c);
- $l_{eff}$  is the effective length of the magnet (usually different from the mechanical length, due to fringe fields at the end of the magnet);
- $\theta_{B,x}$  is the deflection angle due to the magnetic field (rads).

06/11/2013

CAS: Septa & Kickers. M.J. Barnes.

7

## Example of Deflection by Force in an Electric Field

Opposites Attract !

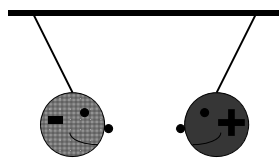

Charge moving into plane of paper ●

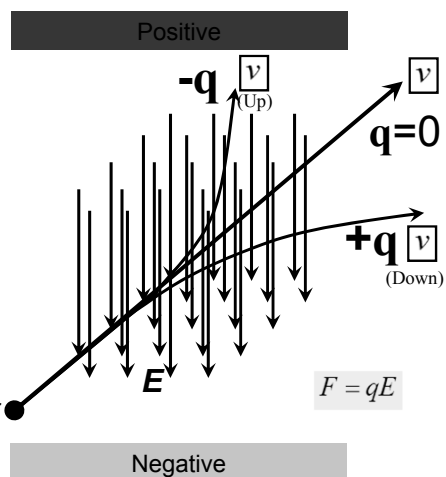

06/11/2013

CAS: Septa & Kickers. M.J. Barnes.

8

## Beam Deflection due to an Electric Field

$$\theta_{E,x} = \tan^{-1} \left[ \frac{1}{(p \cdot 10^9) \cdot \beta} \cdot \int_{z_0}^{z_1} |E_x| dz \right] = \tan^{-1} \left[ \frac{|E_y| \cdot l_{eff}}{(p \cdot 10^9) \cdot \beta} \right] = \tan^{-1} \left[ \frac{V_y \cdot l_{eff}}{d \cdot (p \cdot 10^9) \cdot \beta} \right]$$

Where:

- $E$  is electric field (V/m);
- $p$  is beam momentum (GeV/c);
- $\beta$  is a unit-less quantity that specifies the fraction of the speed of light at which the particles travel;
- $l_{eff}$  is the effective length of the magnet (usually different from the mechanical length, due to fringe fields at the end of the magnet);
- $V$  is voltage (V);
- $d$  is gap (m);
- $\theta_{E,x}$  is the deflection angle due to the electric field (rads).

Usually fixed by beam considerations

06/11/2013

CAS: Septa & Kickers. M.J. Barnes.

9

In general: a septum (plural septa) is a partition that separates two cavities or spaces.

In a particle-accelerator a **septum** is a device which separates two field regions:

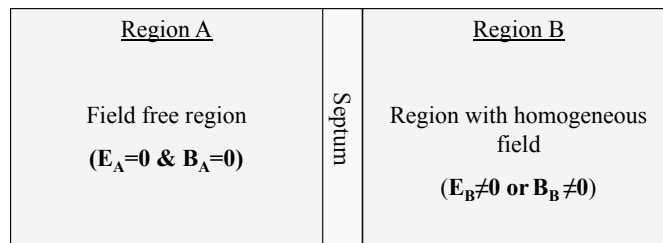

Important features of septa are a homogeneous field in one region, for deflecting beam, and a low fringe field next to the magnet so as not to affect the circulating beam.

06/11/2013

CAS: Septa & Kickers. M.J. Barnes.

10

## Single-Turn Injection – horizontal plane

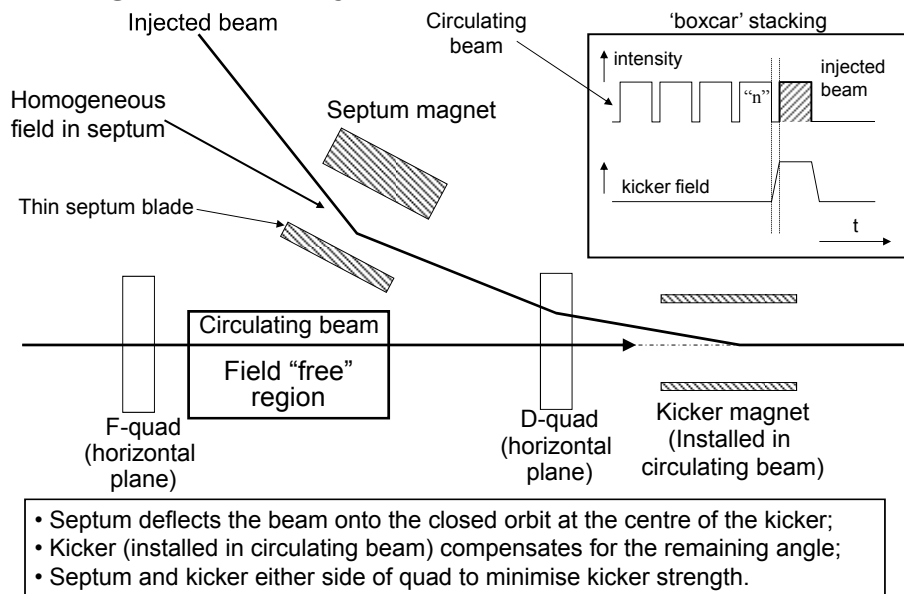

06/11/2013

CAS: Septa & Kickers. M.J. Barnes.

11

## Fast Extraction uses a Kicker and a Septum

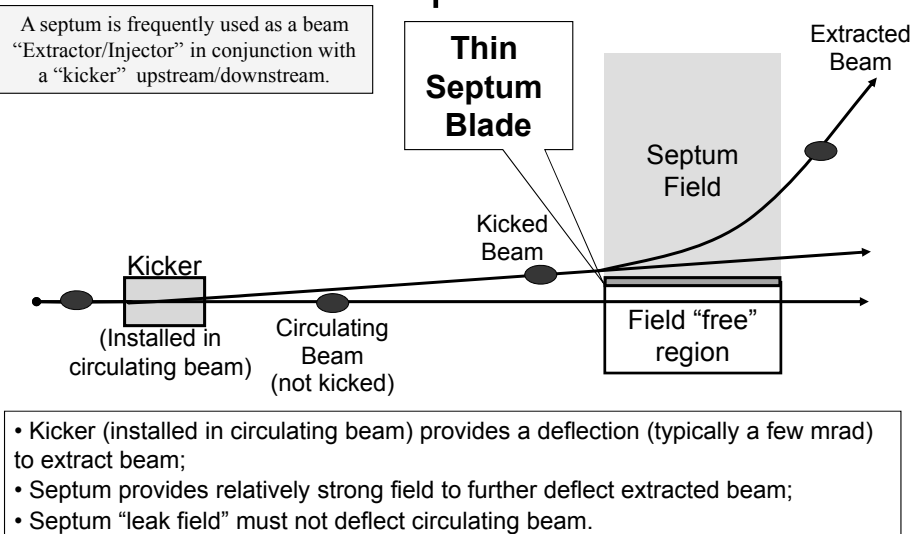

06/11/2013

CAS: Septa & Kickers. M.J. Barnes.

12

# Septa

The goal is to construct a magnet with a septum conductor **as thin as possible**, to “ease” the task of elements such as kickers.

- Main Types:
  - Electrostatic Septum (DC);
  - DC Magnetic Septum;
  - Direct Drive Pulsed Magnetic Septum;
  - Eddy Current Septum;
  - Lambertson Septum (deflection orthogonal to kicker deflection).
- Main Difficulties:
  - associated with Electrostatic septa is surface conditioning for High Voltage;
  - associated with Magnetic septa are not electrical but rather mechanical (cooling, support of this septum blades, radiation resistance).

06/11/2013

CAS: Septa & Kickers. M.J. Barnes.

13

## “C” Magnet $\Rightarrow$ Septum Magnet

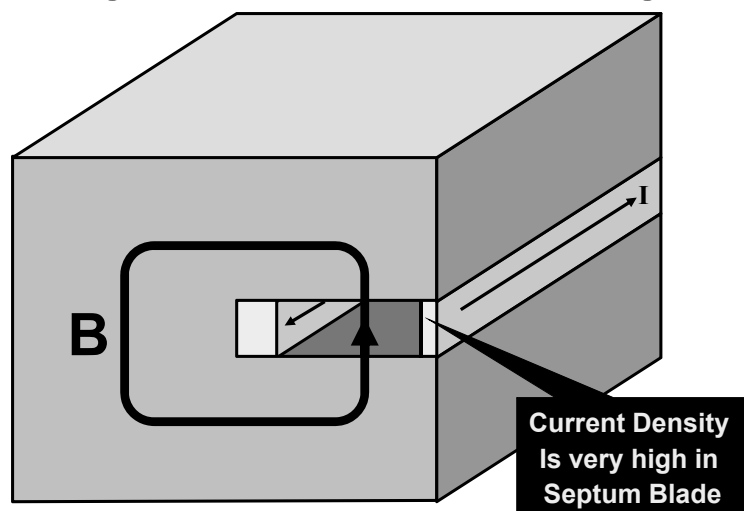

06/11/2013

CAS: Septa & Kickers. M.J. Barnes.

14

# Extraction

- Different extraction techniques exist, depending on requirements:
  - Slow extraction of beam:
    - Experimental facilities generally use slow extracted beam. An optimum slow extracted beam has a smooth, uniform spill.
  - Fast, single-turn, extraction of beam:
    - Fast, single-turn, extraction is used in the transfer of beam from one acceleration stage to another.
- Usually higher energy than injection  $\Rightarrow$  stronger elements (e.g.  $\int B \cdot dl$ ):
  - At high energies many kicker and septum modules may be required;
  - To reduce kicker and septum strength, beam can be moved near to septum by closed orbit bump (true of injection too).

06/11/2013

CAS: Septa & Kickers. M.J. Barnes.

15

## Septum for Multi-Turn Extraction

Beam bumped to septum; part of beam 'shaved' off each turn:

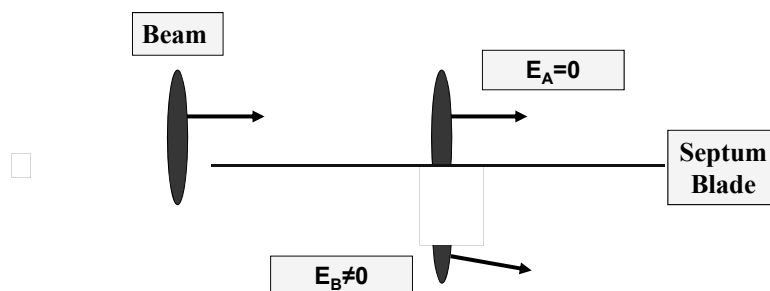

Septum blade must be very thin (e.g.  $<0.1$ mm) to limit magnitude of losses: hence an electrostatic septum is generally used.

06/11/2013

CAS: Septa & Kickers. M.J. Barnes.

16



## Extraction with an Electrostatic Septum (1)

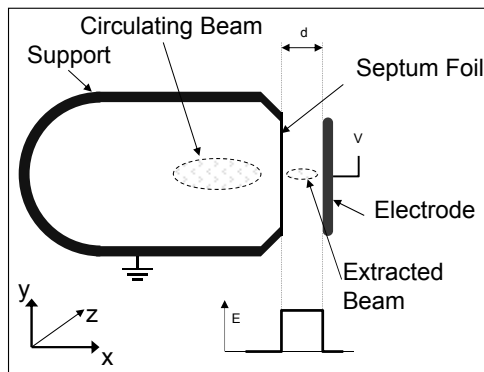

Thin septum foil gives small interaction with beam.

Orbiting beam passes through hollow support of septum foil (field free region).

Extracted beam passes just on the other side of the septum (high, homogeneous, field region).

Electrostatic septa generally use vacuum as an insulator, between septum and electrode, and are therefore normally in a vacuum tank.

To allow precise matching of the septum position with the circulation beam trajectory, the magnet is also often fitted with a displacement system, which allows parallel and angular movement with respect to the circulating beam.

06/11/2013

CAS: Septa & Kickers. M.J. Barnes.

17

## Extraction with an Electrostatic Septum (2)

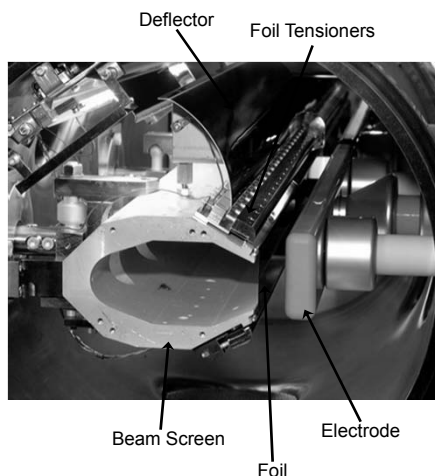

### Typical technical specifications:

- Electrode length : 500 - 3000 mm;
- Gap width (d) variable: 10 - 35 mm;
- Septum thickness:  $\leq 0.1$  mm;
- Vacuum ( $10^{-9}$  to  $10^{-12}$  mbar range);
- Voltage: up to 300 kV;
- Electric field strength: up to 10 MV/m;
- Septum Molybdenum foil or Tungsten wires;
- Electrode made of anodised aluminium, Stainless Steel or titanium for extremely low vacuum applications;
- Bake-able up to 300 °C for vacuum in  $10^{-12}$  mbar range;
- Power supplied by Cockroft-Walton type high voltage generator.

06/11/2013

CAS: Septa & Kickers. M.J. Barnes.

18

## Extraction with a DC Magnetic Septum (1)

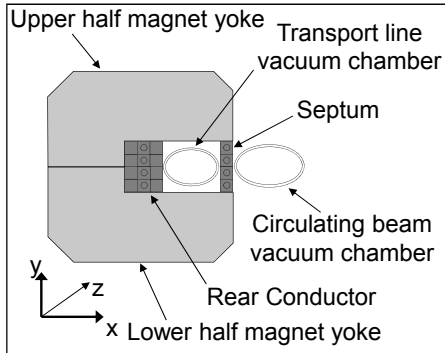

Continuously powered with a (high) current. Usually constructed with a multi-turn (series) coil, so as to reduce the current needed. The coil and the magnet yoke can be split in two, an upper and a lower part, to allow the magnet to be 'clamped' over the vacuum chamber of the extraction line. Rarely under vacuum.

06/11/2013

CAS: Septa & Kickers. M.J. Barnes.

19

## Extraction with a DC Magnetic Septum (2)

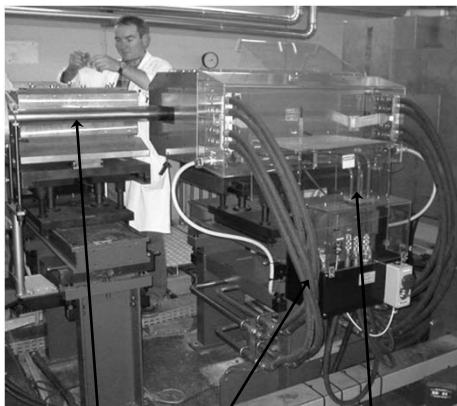

### **Typical technical specifications:**

- Magnetic length per magnet yoke: 400 - 1200 mm;
- Gap height: 25 - 60 mm;
- Septum thickness: 6 - 20 mm;
- Outside vacuum;
- Laminated steel yoke;
- Multi turn coil, with water cooling circuits (12 - 60 l/min.);
- Current range: 1 - 10 kA;
- Power supplied by controllable rectifier;
- Power consumption: 10 - 100 kW !.

Circulating Beam

Cooling

Electrical Connections

06/11/2013

CAS: Septa & Kickers. M.J. Barnes.

20

## Direct Drive Pulsed Magnetic Septum (1)

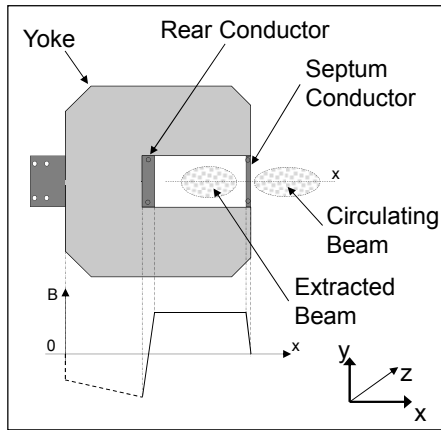

Powered with a half sine wave current with a half period time of typically 3 ms.

Coil is generally constructed as a single turn, so as to minimize magnet self-inductance.

A transformer is used between power supply and magnet to allow use of standard 2kV capacitors.

To allow precise matching of the septum position with the circulation beam trajectory, the magnet is also often fitted with a remote displacement system.

Often under vacuum to minimize distance between circulating and extracted beam.

06/11/2013

CAS: Septa & Kickers. M.J. Barnes.

21

## Direct Drive Pulsed Magnetic Septum (2)

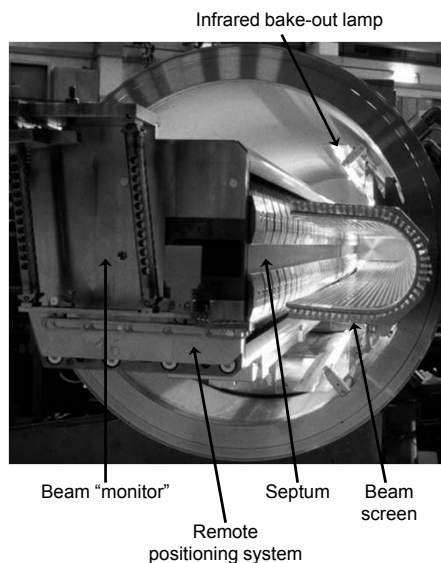

### **Typical technical specifications:**

- Magnetic length per magnet yoke: 300 - 1200 mm;
- Gap height: 18 - 60 mm;
- Septum thickness: 3 - 20 mm;
- Vacuum ( $\sim 10^{-9}$  mbar);
- Laminated steel yoke of 0.35 mm - 1.5 mm thick laminations;
- Single turn coil, with water cooling circuits (1 - 80 l/min.);
- Bake-able up to 200 °C;
- Current: half-sine 7 - 40 kA, half-period  $\sim 3$  ms;
- Power supplied by capacitor discharge; flat top of the current improved with 3rd harmonic circuit and active filters – (rectifier circuit used for up to 6s “pulse”);
- A transformer is used between power supply and magnet.

06/11/2013

CAS: Septa & Kickers. M.J. Barnes.

22

## Eddy Current Magnetic Septum (1)

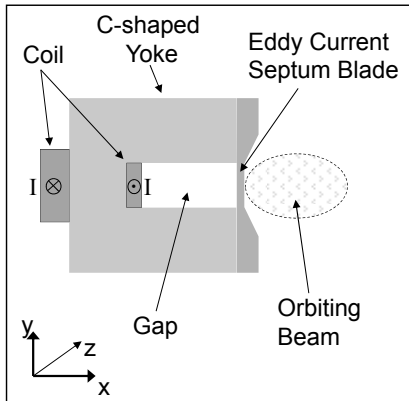

Powered with a half or full sine wave current with a period of typically  $50 \mu\text{s}$ .

Coil is generally constructed as a single turn, so as to minimize magnet self-inductance.

The coil sits around the back leg of the C shaped yoke, and therefore coil dimensions are generally not critical.

When the magnet is pulsed, the magnetic field induces eddy currents in the septum blade, counteracting the fringe field created.

The septum can be made very thin, but water circuits may be needed at the edges to cool the septum.

The field in the gap as function of time follows the coil current. The electrical resistance of the septum is kept low: once the septum current is flowing, it takes quite some time to decay away.

06/11/2013

CAS: Septa & Kickers. M.J. Barnes.

23

## Eddy Current Magnetic Septum (2)

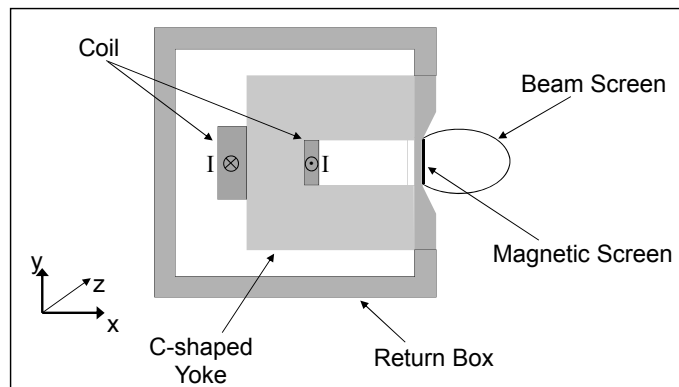

To reduce further the fringe field of the eddy current septum a copper box (return box) can be placed around the septum magnet. Also a magnetic screen can be added next to the septum conductor. These modifications permit the fringe field to be reduced to below  $1/1000$  of the gap field at all times and places.

06/11/2013

CAS: Septa & Kickers. M.J. Barnes.

24

## Eddy Current Magnetic Septum (3)

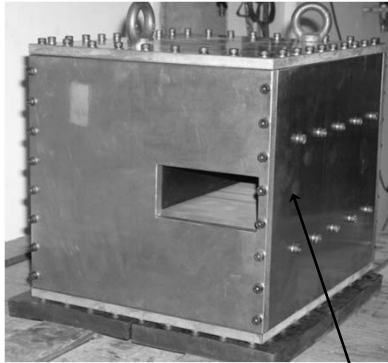

BS1 Prototype Eddy Current Septum

Septum Blade

### Typical technical specifications:

- Magnetic length per magnet yoke: 400 - 800 mm;
- Gap height: 10 - 30 mm;
- Septum thickness: 1 - 3 mm;
- Vacuum ( $\sim 10^{-9}$  mbar), or out of vacuum;
- Steel yoke with 0.1 - 0.35 mm thick laminations;
- Single turn coil, with water cooling circuits (1 - 10 l/min.);
- Current:  $\sim 10$  kA;
- Fast pulsed : 50  $\mu$ s;
- Powered with a capacitor discharge; half-sine or full sine-wave.

06/11/2013

CAS: Septa & Kickers. M.J. Barnes.

25

## Lambertson Septum (principle)

- Current: DC or pulsed;
- Conductors are enclosed in steel yoke, "well away" from beam;
- Thin steel yoke between Aperture and circulating beam – however extra steel required to avoid saturation;
- Septum, as shown, difficult to align.

- Extraction Septum shown:
  - Use kicker to deflect beam horizontally into aperture;
  - Lambertson deflects beam vertically (orthogonal to kicker deflection).

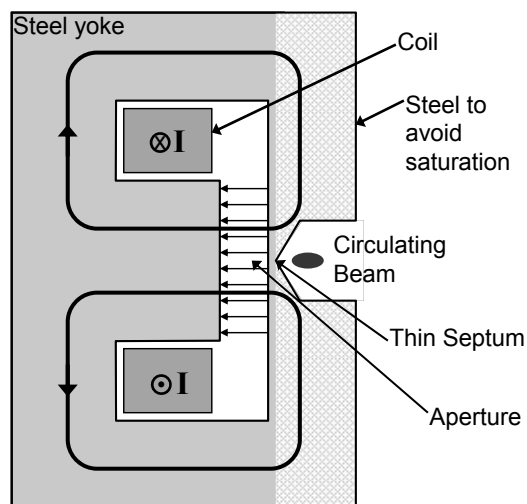

06/11/2013

CAS: Septa & Kickers. M.J. Barnes.

26

# LHC Injection – Lambertson Septum

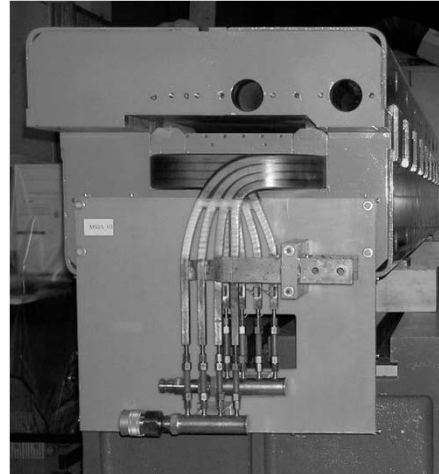
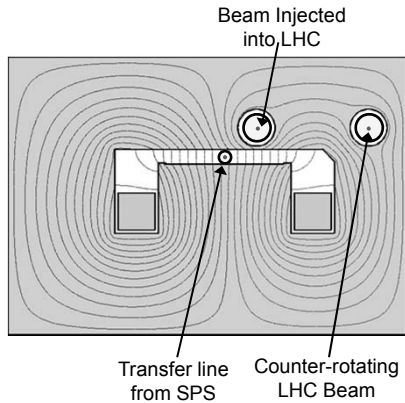

1. Septum deflects beam horizontally to the right;
2. Kicker deflects beam vertically onto central orbit.
3. Note: To minimize field in LHC beam-pipes, additional screen is used.

06/11/2013

CAS: Septa & Kickers. M.J. Barnes.

27

# Powering Pulsed Septa

## Third Harmonic Circuit:

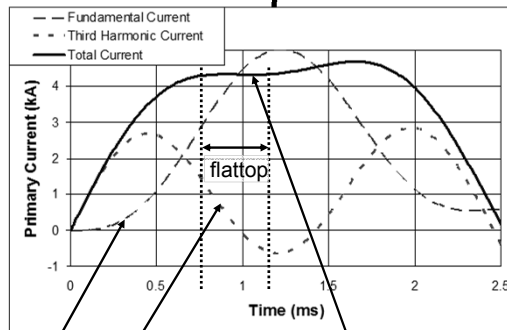
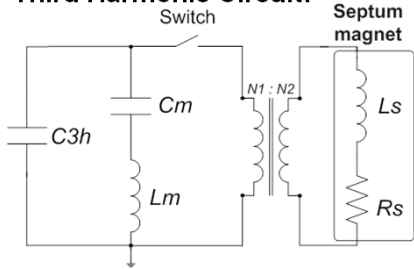

**A third harmonic circuit is used to obtain a better flattop current than a basic sinusoidal discharge current:**

- The capacitors are accurately charged to the required voltage;
- **The third harmonic circuit generates a current** which is superimposed upon (adds to) the **discharge current of the fundamental current.**
- A transformer is used to allow the use of standard 2kV capacitors on the primary and to give the required high current on the secondary.
- An active filter circuit (not shown) can be used to obtain a stability of flattop current of  $10^{-4}$  over a time of  $500\mu\text{s}$ .

06/11/2013

CAS: Septa & Kickers. M.J. Barnes.

28

## Bibliography for Septa

- M.J. Barnes, J. Borburgh, B. Goddard, M. Hourican, "Injection and Extraction Magnets: Septa", CERN Accelerator School CAS 2009: Specialised Course on Magnets, Bruges, 16-25 June 2009, arXiv:1103.1062 [physics.acc-ph].
- J. Borburgh, M. Crescenti, M. Hourican, T. Masson, "Design and Construction of the LEIR Extraction Septum", IEEE Trans. on Applied Superconductivity, Vol. 16, No. 2, June 2006, pp289-292.
- M.J. Barnes, B. Balhan, J. Borburgh, T. Fowler, B. Goddard, W.J.M. Weterings, A. Ueda, "Development of an Eddy Current Septum for LINAC4", EPAC 2008.
- J. Borburgh, B. Balhan, T. Fowler, M. Hourican, W.J.M. Weterings, "Septa and Distributor Developments for H- Injection into the Booster from Linac4", EPAC 2008.
- S.Bidon, D.Gerard, R.Guinand, M.Gyr, M.Sassowsky, E.Weisse, W.Weterings, A.Abramov, A.Ivanenko, E.Kolatcheva, O.Lapyguina, E.Ludmirsky, N.Mishina, P.Podlesny, A.Riabov, N.Tyurin, "Steel Septum Magnets for the LHC Beam Injection and Extraction", Proc. of EPAC 2002, Paris.
- J.M. Cravero & J.P. Royer, "The New Pulsed Power Converter for the Septum Magnet in the PS Straight Section 42", CERN PS/PO/ Note 97-03, 1997.
- J.P. Royer, "High Current with Precision Flat-Top Capacitor Discharge Power Converters for Pulsed Septum Magnets", CERN/PS 95-13 (PO), 1995.
- <http://psdata.web.cern.ch/psdata/www/septa/xseh.htm>.

06/11/2013

CAS: Septa & Kickers. M.J. Barnes.

29

## Kickers

06/11/2013

CAS: Septa & Kickers. M.J. Barnes.

30

## Fast Single-Turn Extraction – same plane

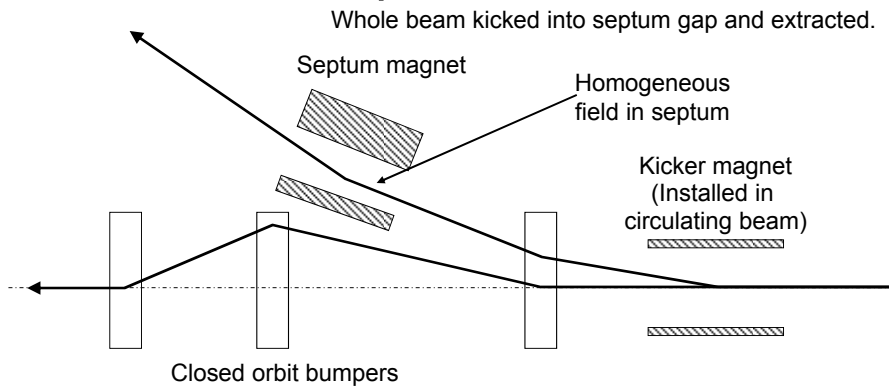

- Kicker deflects the entire beam into the septum in a single turn (time selection [separation] of beam to be extracted);
- Septum deflects the beam entire into the transfer line (space separation of circulating and extracted beam).

06/11/2013

CAS: Septa & Kickers. M.J. Barnes.

31

## Fast Single Turn Injection/Extraction

- Kickers are used for transfer of beams between accelerators and for dumping beam.
- Septum deflection may be in the other plane to the kicker deflection.
- The kicker magnetic field must rise/fall within the time period between the beam bunches, without deviating from the flat top and bottom of the pulse
  - Typical field rise/fall times range from tens to hundreds of nanoseconds and pulse width ranging from tens of nanoseconds to tens of microseconds;
- If a kicker exhibits a time-varying structure in the pulse shape this can translate into small offsets with respect to the closed orbit (betatron oscillations).
- **A fast (pulse forming) circuit is required !**

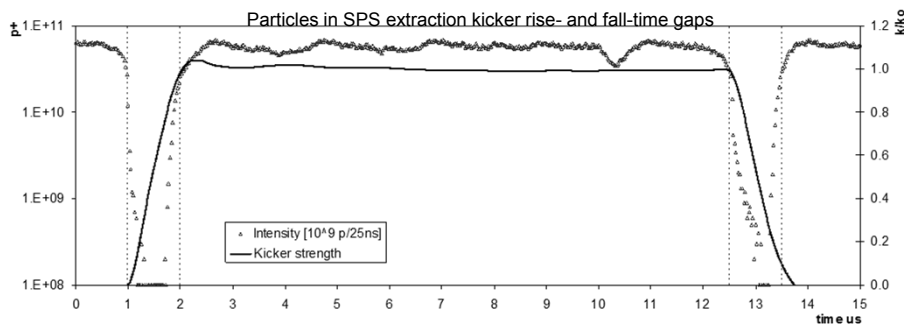

06/11/2013

CAS: Septa & Kickers. M.J. Barnes.

32



# Characteristic Impedance of Coaxial Cable

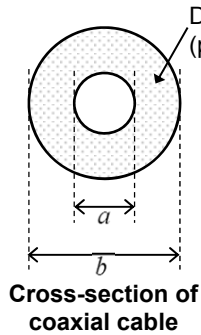

Dielectric (permittivity  $\epsilon_r$ )  
 Capacitance per metre length (F/m):  $C = \left( \frac{2\pi\epsilon_0\epsilon_r}{\ln(b/a)} \right)$

Inductance per metre length (H/m):  $L = 2 \cdot 10^{-7} \cdot \ln\left(\frac{b}{a}\right)$

Characteristic Impedance ( $\Omega$ ): (typically 20  $\Omega$  to 50  $\Omega$ ).  
 $Z_0 = \sqrt{\frac{L}{C}}$

Delay per metre length:  
 (~5ns/m for suitable coax cable).  
 $\tau = \sqrt{L \cdot C}$

Where:

- a is the outer diameter of the inner conductor (m);
- b is the inner diameter of the outer conductor (m);
- $\epsilon_0$  is the permittivity of free space ( $8.854 \times 10^{-12}$  F/m).

06/11/2013

CAS: Septa & Kickers. M.J. Barnes.

33

# Pulse Forming Circuit: General Case

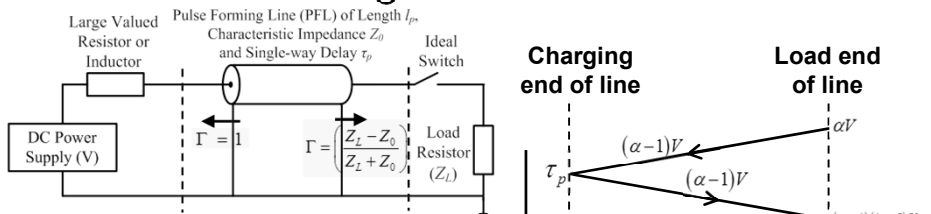

- At  $t=0$ , when the ideal switch closes, the load potential ( $V_L$ ) is given by:

$$V_L = V \cdot \left( \frac{Z_L}{Z_0 + Z_L} \right) = \alpha V$$

A voltage pulse of " $(\alpha-1)V$ " propagates from the load end of the line towards the charging end.

- At the charging end the reflection coefficient ( $\Gamma$ ) is +1 and hence " $(\alpha-1)V$ " is reflected back towards the load end of the line.

- At the load end of the line:

$$\Gamma = \left( \frac{Z_L - Z_0}{Z_L + Z_0} \right) = \beta \leftarrow \text{say.}$$

and hence " $\beta(\alpha-1)V$ " is reflected back towards the charging end of the line.

- Etc.

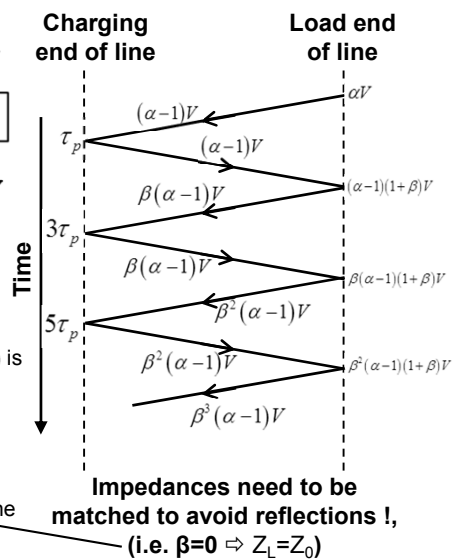

06/11/2013

CAS: Septa & Kickers. M.J. Barnes.

34

## Pulse Forming Circuit: Matched Load ( $Z_L = Z_0$ )

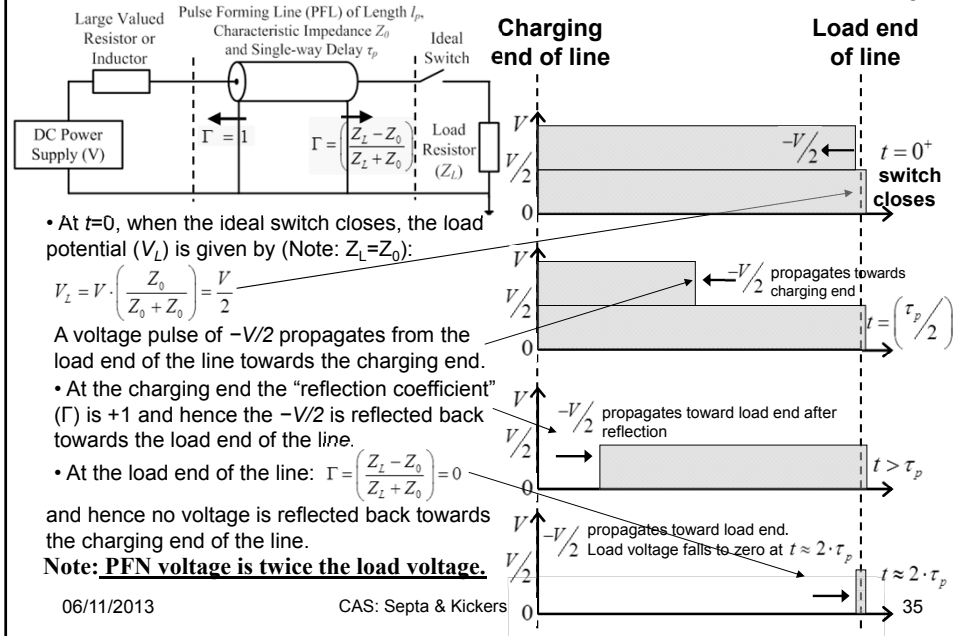

## Simplified Schematic of Kicker System

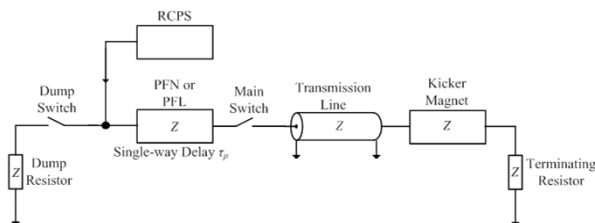

- Typically matched impedances;
- PFL = Pulse Forming Line (coaxial cable);
- PFN = Pulse Forming Network (lumped elements);
- RCPS = Resonant Charging Power Supply;
- Floating switch.

### Typical circuit operation:

- PFN/PFL is charged to a voltage  $V_p$  by the RCPS;
- Main Switch closes and a pulse of magnitude  $(V_p/2)$  is launched, through the transmission line, towards the magnet.
- Once the current pulse reaches the (matched) terminating resistor full-field has been established in the kicker magnet;
- The length of the pulse in the magnet can be controlled in length, between 0 and  $2\tau_p$ , by adjusting the timing of the Dump Switch relative to the Main Switch.
  - Note: the Dump Switch may be an inverse diode: the diode will "automatically" conduct if the PFN voltage reverses, but there is no control over pulse-length.

06/11/2013

CAS: Septa & Kickers. M.J. Barnes.

36

## Angular Deflection Due To Magnetic and Electric Fields

Key:

- Proton beam moving out of plane of paper;
- ⊗ Current flow into plane of paper;
- ⊙ Current flow out of plane of paper;

$$\theta_{B,x} = \left[ \frac{0.3}{p} \right] \cdot \int_{z_0}^{z_1} |B_y| dz = \left[ \frac{0.3 (l_{eff})}{p} \right] \cdot |B_y|$$

$$\theta_{E,x} = \tan^{-1} \left[ \frac{1}{(p \cdot 10^9) \cdot \beta} \cdot \int_{z_0}^{z_1} |E_x| dz \right] = \tan^{-1} \left[ \frac{|E_x| \cdot l_{eff}}{(p \cdot 10^9) \cdot \beta} \right]$$

$$\theta_x = \theta_{B,x} \pm \theta_{E,x}$$

Where:

- $p$  is beam momentum (GeV/c);
- $\beta$  is a unit-less quantity that specifies the fraction of the speed of light at which the particles travel;
- $l_{eff}$  is the effective length of the magnet (usually different from the mechanical length, due to fringe fields at the end of the magnet).

06/11/2013

CAS: Septa & Kickers. M.J. Barnes.

37

## Electrical Parameters for a Magnetic Kicker

Usually 1 for a kicker magnet

$$B_y \cong \mu_0 \left( \frac{N \cdot I}{V_{ap}} \right)$$

Minimum value set by beam parameters  
Hence: "I" determines  $B_y$

Minimum value set by beam parameters

$$L_{m/m} \cong \mu_0 \left( \frac{N^2 \cdot H_{ap}}{V_{ap}} \right)$$

Where:

- $\mu_0$  is permeability of free space ( $4\pi \times 10^{-7}$  H/m);
- $N$  is the number of turns;
- $I$  is current (A);
- $H_{ap}$  is the distance between the inner edges of the HV and return conductors (m);
- $V_{ap}$  is the distance between the inner "legs" of the ferrite (m);
- $L_{m/m}$  is inductance per metre length of the kicker magnet (H/m).

06/11/2013

CAS: Septa & Kickers. M.J. Barnes.

38

# Kicker Magnets

In general kicker magnets have to be fast and therefore usually only have a single turn: multi-turns are only used for, slower, lumped inductance kicker magnets.



## Design options for kicker magnets:

1. Type: "lumped inductance" or "transmission line" (with specific  $Z$ ) ?;
2. Machine vacuum: install in or external to machine vacuum?;
3. Aperture: window frame, closed C-core or open C-core ?;
4. Termination: matched impedance or short-circuited ?.

06/11/2013

CAS: Septa & Kickers. M.J. Barnes.

39

# Lumped Inductance Kicker Magnets

Although a lumped-type magnet has a simple structure, in most cases it cannot be applied to a fast kicker system because of its impedance mismatch and its slow response. The lumped inductance kicker is generally useable only when a rise time above a few hundreds of ns is required. The termination is generally either in series with the magnet input or else the magnet is short-circuited. In both cases the magnet only sees (bipolar) voltage during pulse rise & fall. With a short-circuit termination, magnet current is doubled.

## Magnet current rise for a step input voltage:

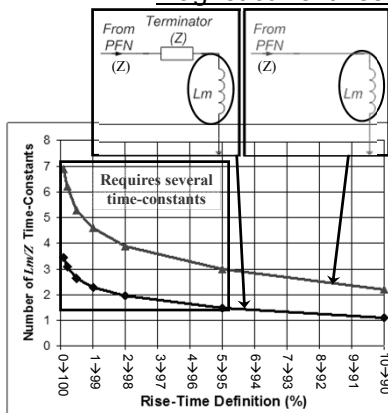

A capacitor can be added to a lumped inductance magnet, but this can provoke some overshoot:

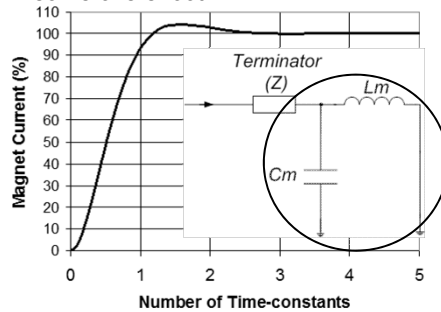

06/11/2013

CAS: Septa & Kickers. M.J. Barnes.

40

# Transmission Line Kicker Magnet:

- Developed at CERN in early 1960's;
- Consists of few to many "cells" to approximate a coaxial cable;

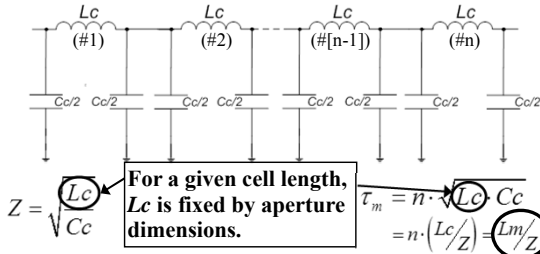

- Ferrite C-cores are sandwiched between high voltage (HV) capacitance plates;
- One C-core, together with its ground and HV capacitance plates, is termed a cell. Each cell conceptually begins and ends in the middle of the HV capacitance plates;
- The "filling time" ( $\tau_m$ ) is the delay required for the pulse to travel through the "n" magnet cells.

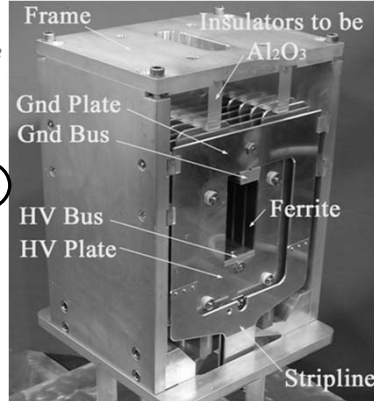

06/11/2013

CAS: Septa & Kickers. M.J. Barnes.

41

# Transmission Line Kicker Magnet:

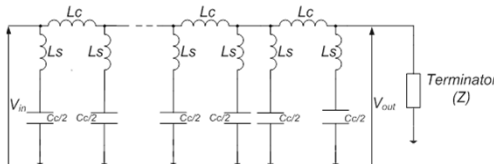

For a magnet terminated with a matched resistor: **field rise** time starts with the beginning of the voltage pulse at the entrance of the magnet and ends with the end of the same pulse at the output. **Field rise** is given by the sum of the voltage rise time and the magnet filling time ( $= L_m/Z$ ):

$$\phi = \int (V_{in} - V_{out}) dt$$

The field builds up until the end of the voltage rise at the output of the magnet. Hence it is important that the pulse does not degrade while travelling through the magnet. Thus the magnet cut-off frequency is a key parameter, especially with field rise times below ~100 ns. Cut-off frequency ( $f_c$ ) depends on series inductance ( $L_s$ ) associated with the cell capacitor ( $C_c$ ):  $f_c = \frac{1}{\pi \cdot \sqrt{(L_c + 4L_s) \cdot C_c}}$

Thus,  $L_s$  should be kept as low as possible and the cell size small. However cells cannot be too small (voltage breakdown & cost).

**Transmission line kicker magnets have much faster field rise time than equivalent lumped magnets. However, design and construction is more complicated and costly.**

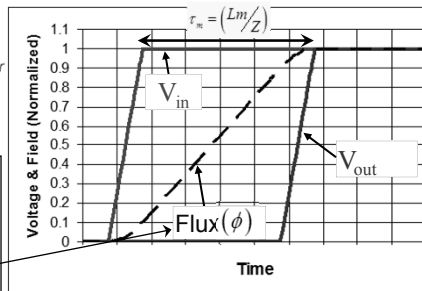

06/11/2013

CAS: Septa & Kickers. M.J. Barnes.

42

## Installing kicker magnets in machine vacuum:

### Disadvantages:

- Costly to construct (bake-out, vacuum tank, pumping);
- Coupling impedance to beam (a ceramic tube, suitably treated, may be required in any case).

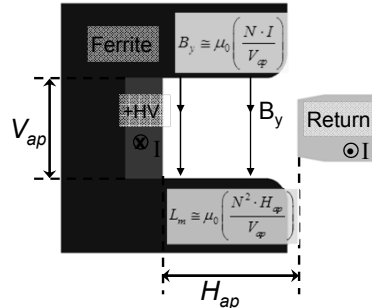

### Advantages:

- Aperture dimensions are minimized;
- Therefore voltage and current are minimized for a given kick, rise-time and length (number of magnets is minimized);
- Machine vacuum is a reliable dielectric (70kV/cm OK) – generally “recovers” after a flashover, whereas a solid dielectric, outside vacuum, may not recover.

06/11/2013

CAS: Septa & Kickers. M.J. Barnes.

43

## Transmission Line Kicker Magnet

- Transmission line magnets are usually installed in a vacuum chamber to withstand high voltage between the capacitor plates;
- In this case, a vacuum enclosure with expensive feedthroughs is necessary;
- Careful bake-out is required to control out-gassing from the ferrite core and therefore beam loss.

### LHC Injection Kicker

- 2.7m long magnet;
- 33 cells;
- $L_c \approx 100\text{nH}$ ,  $C_c \approx 4\text{nF}$  (per cell values);
- Fill-time  $\approx 680\text{ns}$ ;
- $5\Omega$  characteristic impedance.

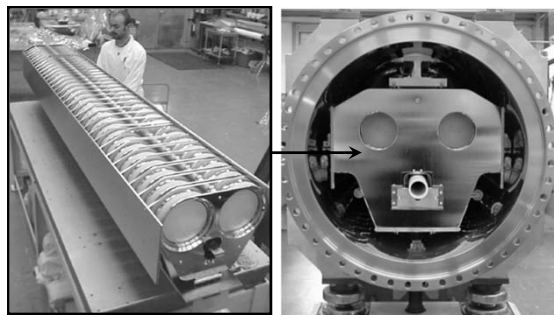

06/11/2013

CAS: Septa & Kickers. M.J. Barnes.

44

## Kicker Magnet Magnetic Circuit

- Normally a magnetic circuit is used which contains magnetic material: without magnetic material the effective value of  $V_{ap}$  is greatly increased, therefore requiring more current to achieve the required field. In addition, magnetic material improves field uniformity.
- NiZn Ferrite is usually used, with  $\mu_r \approx 1000$ :
  - Field rise can track current rise to within  $\sim 1\text{ns}$ ;
  - Has low remnant field;
  - Has low out-gassing rate, after bake-out.
- Sometimes the return conductor is behind the yoke (for beam gymnastic reasons) – this increases  $L_c$  by about 10%.
- To reduce filling time by a factor of two FNAL and KEK use a window frame topology:
  - It can be considered as two symmetrical C-magnets energized independently.
  - Requires two generators to achieve the reduced filling time.
  - Conducting “shields” are used between the two ferrite C-cores to reduce beam coupling impedance.

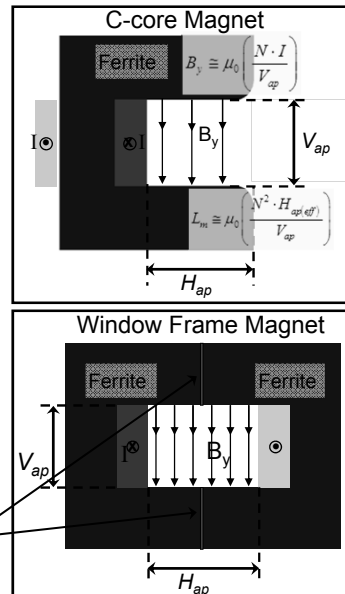

06/11/2013

CAS: Septa & Kickers. M.J. Barnes.

45

## Transmission Line Kicker Magnet Termination

When space is at a premium, a short circuit termination has the advantage of doubling kick (for a given system impedance): in addition, a short circuit termination reduces the time during which the magnet is exposed to high voltage.

However disadvantages include:

- fill-time of the kicker magnet is doubled;
- magnet experiences voltage of both polarities;
- if the dump-switch is used to control pulse length it must be bi-directional (uni-directional is suitable if dump-switch is only acting as an inverse diode, i.e. not controlling pulse length);
- beam can be affected (resonances, below magnet cut-off frequency, with kicker circuitry).

06/11/2013

CAS: Septa & Kickers. M.J. Barnes.

46

# Beam Coupling Impedance

In order to reduce beam coupling impedance the ferrite must be shielded from the beam, by providing a path for beam image current. However the design must ensure that eddy-currents, induced by the fast rising field, do not unduly increase field rise-time.

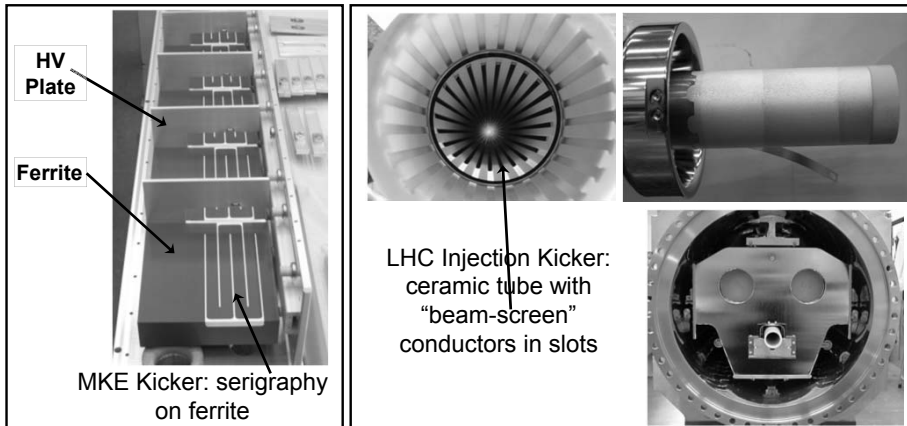

06/11/2013

CAS: Septa & Kickers. M.J. Barnes.

47

# Pulse Forming Line (PFL)

- Simplest configuration is a PFL charged to **twice the needed pulse voltage**;
- PFL (cable) give ripple free pulses, but low attenuation is essential (especially with longer pulses) to keep droop and "cable tail" within specification;
- Attenuation is adversely affected by the use of semiconductor layers to improve voltage rating;
- Hence, for PFL voltages above 50kV, SF6 pressurized PE tape cables are used.



Reels of PFL

PFL (cable) becomes costly, bulky and the droop becomes significant (e.g. ~1%) for pulses exceeding about  $3\mu\text{s}$  width.

06/11/2013

CAS: Septa & Kickers. M.J. Barnes.

48



# Pulse Forming Network (PFN)

A PFN is an artificial coaxial cable made of lumped elements.

## Schematic for an LHC Injection PFN:

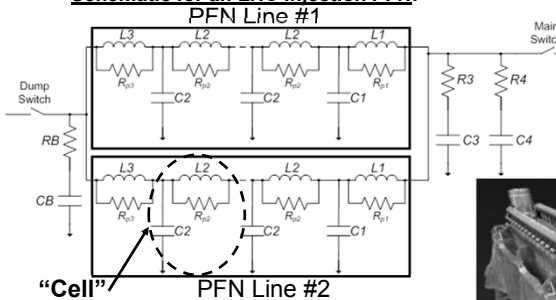

"Cell" PFN Line #2

### System Parameters:

- Field flat top duration  $\leq 7.86\mu\text{s}$ ;
- Field flat top ripple  $< \pm 0.5\%$ ;
- Field rise-time 0.5% to 99.5% =  $0.9\mu\text{s}$ ;
- Kick strength per magnet =  $0.325\text{ T}\cdot\text{m}$ ;
- Nominal PFN Voltage =  $54\text{ kV}$ ;
- Nominal Magnet Current =  $5.4\text{ kA}$ .

06/11/2013

CAS: Septa & Kick

### LHC Injection PFN:

- $5\Omega$  system (two parallel  $10\Omega$  "lines");
- Nominal PFN Voltage =  $54\text{ kV}$ ;
- Single continuous coil per  $10\Omega$  line,  $4.356\text{ m}$  long, with 198 turns and a pitch of  $22\text{ mm}$ ;
- The 26 central cells of the coils are not adjustable and therefore defined with high precision.
- Copper tube wound on a rigid fibreglass coil former.

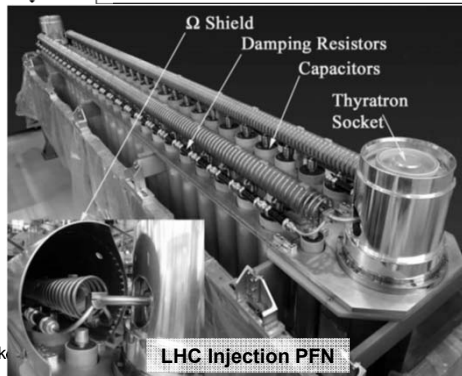

LHC Injection PFN

# Thyratron Switches

In general deuterium thyratrons are used as the power switch.

Three-gap thyratrons can hold-off  $80\text{ kV}$  and switch  $6\text{ kA}$  of current with a  $30\text{ ns}$  rise-time (10% to 90%) [ $\sim 150\text{ kA}/\mu\text{s}$ ].

BUT: care must be taken, e.g. ....

- Coaxial housings for low inductance;
- Adequate insulation to the housing;
- Erratic turn-on (turn-on without a trigger being applied): reduced significantly by "fast" ( $\sim\text{ms}$ ) charging of the PFN/PFL;
- Appropriate thyratron for anticipated short-circuit and fault conditions.

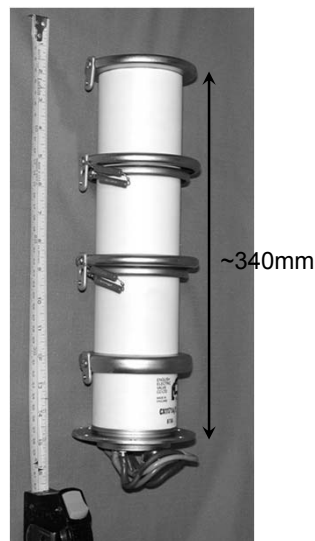

06/11/2013

CAS: Septa & Kickers. M.J. Barnes.

50

# Semiconductor Switches

In some applications thyatron switches cannot be used; e.g. for the dump (abort) kickers in the LHC where the generator voltage must track the beam energy. In this case high power semiconductor switches are used (when rise-time  $\geq 1\mu\text{s}$ ) – to avoid erratic turn-on of a thyatron and to allow a wide dynamic range of operation. Maintenance is significantly reduced with a semiconductor switch.

## LHC dump parameters:

- Ten series GTO's ( $V_{\text{DRM}}=4.5\text{kV}$ );
- Voltage range: 2.2kV – 30kV (450GeV to 7TeV);
- Current range: 1.3kA – 18.5kA;
- Magnet current flat top: 95 $\mu\text{s}$ ;
- Maximum di/dt: 32kA/ $\mu\text{s}$  (~1/5<sup>th</sup> of a thyatron).

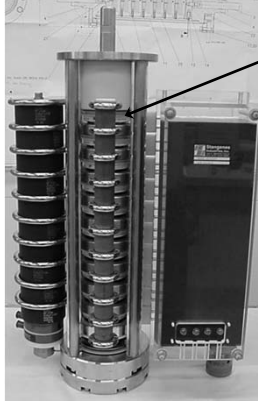

GTO die damaged during testing at high di/dt

06/11/2013

CAS: Septa & Kickers. M.J. Barnes.

51

# CTF3 Tail Clipper: Overview

## Beam Pulse

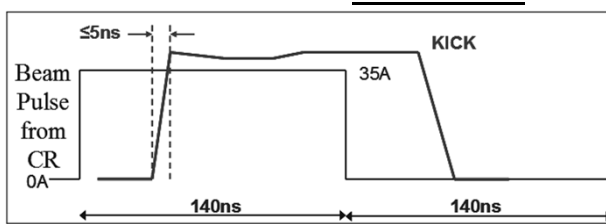

The beam pulse extracted from the CR is 35 A and 140 ns. **The tail-clipper must have a fast field rise-time, of 5 ns or less**, to minimize uncontrolled beam loss. The flatness of the kick pulse is not important as deflected beam is to be thrown away.

## Schematic of Tail-Clipper

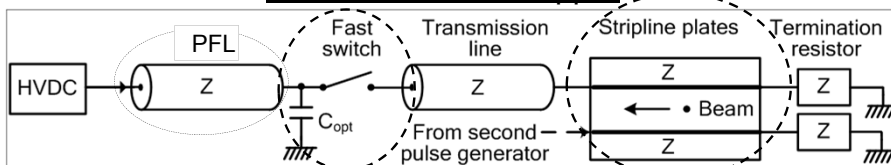

Each (of 8) pulse generator is composed of a 50 $\Omega$  (Z) PFL, a fast semiconductor (Behlke) switch, 50 $\Omega$  stripline plates (no magnetic material) and a matched terminating resistor.

06/11/2013

CAS: Septa & Kickers. M.J. Barnes.

52

# CTF3 Tail Clipper: Striplines

$F_{total} = F_e + F_m$  Note:  $F_e = F_m$  for the tail clipper.

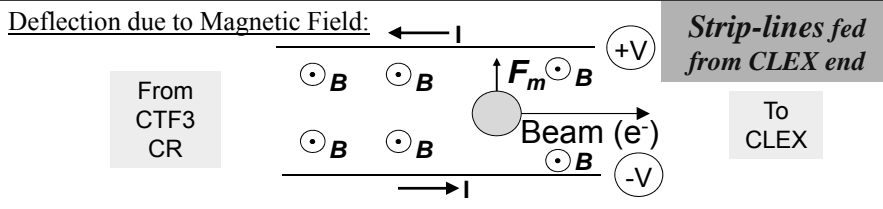
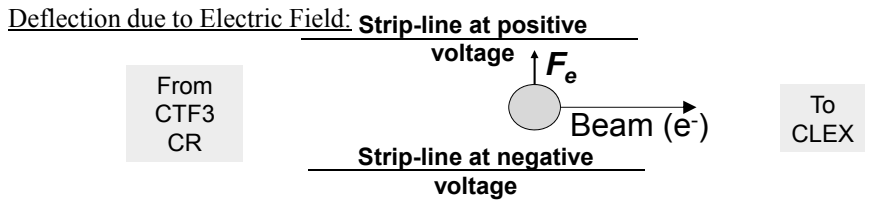
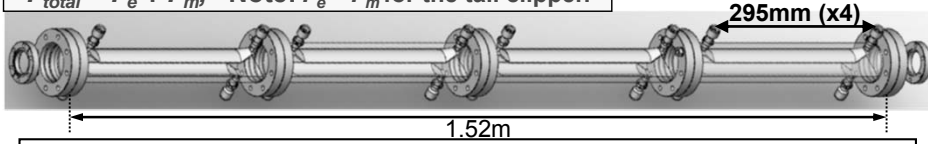

06/11/2013

CAS: Septa & Kickers. M.J. Barnes.

53

# CTF3 Tail-Clipper Hardware

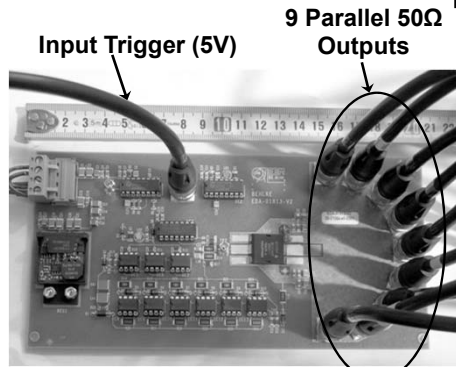

Gate Driver PCB  
(9 Parallel 50Ω Outputs  
[to drive 8 Behlke Switches])

Note: Behlke switch contains series connected, fast turn-on, MOSFETs.

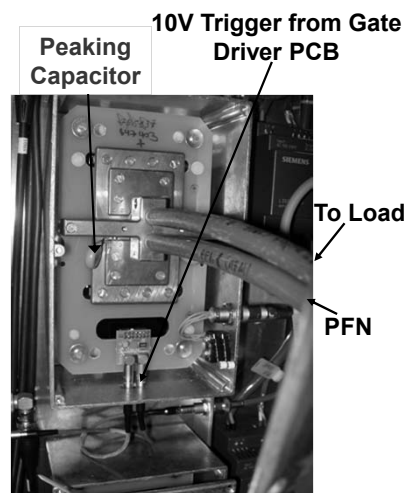

Behlke Switch (8kV, 200A):  
Very Low Inductance Connections

06/11/2013

CAS: Septa & Kickers. M.J. Barnes.

54

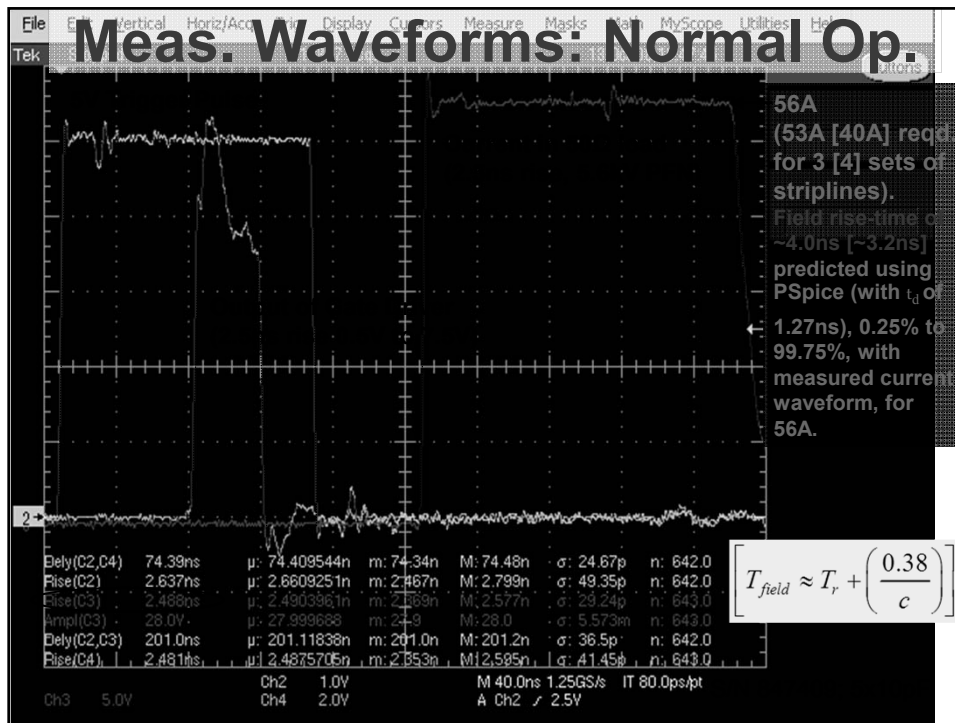

## Bibliography for Kickers

- M.J. Barnes, L. Ducimetière, T. Fowler, V. Senaj, L. Sermeus, "Injection and extraction magnets: kicker magnets", CERN Accelerator School CAS 2009: Specialised Course on Magnets, Bruges, 16-25 June 2009, arXiv:1103.1583 [physics.acc-ph].
- D. Fiander, K.D. Metzmacher, P.D. Pearce, "Kickers and Septa at the PS complex, CERN", Prepared for KAON PDS Magnet Design Workshop, Vancouver, Canada, 3-5 Oct 1988, pp71-79.
- M.J. Barnes, G.D. Wait, I.M. Wilson, "Comparison of Field Quality in Lumped Inductance versus Transmission Line Kicker Magnets", EPAC 1994, pp2547-2549.
- G. Kotzian, M. Barnes, L. Ducimetière, B. Goddard, W. Höfle, "Emittance Growth at LHC Injection from SPS and LHC", LHC Project Report 1116.
- J. N. Weaver et al., "Design, Analysis and Measurement of Very Fast Kicker Magnets at SLAC," Proc of 1989 PAC, Chicago, pp. 411-413.
- L. Ducimetière, N. Garrel, M.J. Barnes, G.D. Wait, "The LHC Injection Kicker Magnet", Proc. of PAC 2003, Portland, USA, pp1162-1164.
- L. Ducimetière, "Advances of Transmission Line Kicker Magnets", Proc. of 2005 PAC, Knoxville, pp235-239.
- W. Zhang, J. Sandberg, J. Tuozzolo, R. Cassel, L. Ducimetière, C. Jensen, M.J. Barnes, G.D. Wait, J. Wang, "An Overview of High Voltage Dielectric Material for Travelling Wave Kicker Magnet Application", proc. of 25th International Power Modulator Conference and High Voltage Workshop, California, June 30-July 3, 2002, pp674-678.
- J. Bonthond, J.H. Dieperink, L. Ducimetière, U. Jansson, E. Vossenber, "Dual Branch High Voltage Pulse Generator for the Beam Extraction of the Large Hadron Collider", 2002 Power Modulator Symposium, Hollywood, USA, 30 June-3 July 2002, pp114-117.
- M.J. Barnes, T. Fowler, G. Ravid, H. Nakajima, "Design & Testing of the Modulator for the CTF3 Tail Clipper Kicker", Proc. of 2nd Euro-Asian Pulsed Power Conference, 22-26 September 2008, Vilnius, Lithuania.